



1.0625Gbps to 11.3Gbps, SFP+ Dual-Path Limiting Amplifier

MAX3945

General Description

The MAX3945 is a +3.3V, multirate, low-power limiting amplifier optimized for Fibre Channel and Ethernet transmission systems at data rates up to 11.3Gbps. The high-sensitivity limiting amplifier limits the signal generated by a transimpedance amplifier into a CML-level differential output signal. All differential inputs and outputs (I/O) are optimally back terminated for 50Ω transmission line PCB design. The MAX3945's dual-path limiting amplifier has programmable filtering to optimize sensitivity for different data rates and to suppress relaxation oscillations that could occur in some optical systems. The MAX3945 incorporates two loss-of-signal (LOS) circuits and a programmable time mask for the LOS output.

A 3-wire digital interface reduces the pin count and enables control of LOS threshold, LOS polarity, LOS mode, CML output level, input offset correction, receive (Rx) polarity, Rx input filter, and Rx deemphasis without the need for external components.

The MAX3945 is packaged in a 3mm x 3mm, 16-pin TQFN package.

Applications

1x/2x/4x/8x SFF/SFP/SFP+ MSA Fibre-Channel Optical Transceiver
10GBASE-SR/LR SFP+ Optical Transceiver
10G PON ONU

Ordering Information

| PART | TEMP RANGE | PIN-PACKAGE |
|-------------|----------------|-------------|
| MAX3945ETE+ | -40°C to +85°C | 16 TQFN-EP* |

+Denotes a lead(Pb)-free/RoHS-compliant package.

*EP = Exposed pad.

Typical Application Circuit appears at end of data sheet.

Features

- ◆ 130mW Power Dissipation Enables < 1W SFP+ Modules
- ◆ Enables Single-Module Design Compliance with 1000BASE-SX/LX and 10GBASE-SR/LR Specifications
- ◆ -25.3dBm Optical Sensitivity at 1.25Gbps Using a 10.32Gbps ROSA
- ◆ Selectable 1GHz/2.1GHz/2.5GHz/3GHz Input Filters at RATE_SEL = 0 Setting
- ◆ Supports SFF-8431 SFP+ MSA and SFF-8472 Digital Diagnostic
- ◆ Total Power Dissipation of 130mW at 3.3V Power Supply with RSSI Monitor-Based LOS
- ◆ Total Power Dissipation of 154mW at 3.3V Power Supply with Rx Input-Based LOS
- ◆ 4mVp-p Input Sensitivity at 11.3Gbps
- ◆ 4psp-p DJ at 11.3Gbps with RATE_SEL = 1
- ◆ 4psp-p DJ at 8.5Gbps with RATE_SEL = 1
- ◆ 5psp-p DJ at 4.25Gbps with RATE_SEL = 0, BW1 = 1, BW0 = 1
- ◆ 9.0psp-p DJ at 1.25Gbps with RATE_SEL = 0, BW1 = 0, BW0 = 0
- ◆ 26ps Rise and Fall Time with RATE_SEL = 1
- ◆ 52ps Rise and Fall Time with RATE_SEL = 0
- ◆ CML Output with Level Adjustment and Squelch Mode
- ◆ Programmable CML Output Deemphasis
- ◆ CML Output Polarity Select
- ◆ LOS Polarity Select
- ◆ Programmable Masking Time for the LOS Output
- ◆ LOS Assert/Deassert Level Adjustment
- ◆ Choice of Rx Input-Based LOS or RSSI Monitor-Based LOS
- ◆ 3-Wire Digital Interface Compatible with Maxim's SFP+ Family of Products

1.0625Gbps to 11.3Gbps, SFP+ Dual-Path Limiting Amplifier

ABSOLUTE MAXIMUM RATINGS

| | | | |
|--|------------------------------|---|-----------------|
| VCC..... | -0.3V to +4.0V | Current Out of ROUT+, ROUT- | 40mA |
| Voltage Range at SDA, SCL, CSEL, LOS, CAZ, RPMIN..... | -0.3V to (VCC + 0.3V) | Continuous Power Dissipation (TA = +70°C) | |
| Voltage Range at ROUT+, ROUT- | (VCC - 2V) to (VCC + 0.3V) | 16-Pin TQFN (derate 14.7mW/°C above +70°C)..... | 1.176W |
| Voltage Range at RIN+, RIN-..... | (VCC - 1.7V) to (VCC + 0.3V) | Operating Junction Temperature Range | -55°C to +150°C |
| Current Range Into LOS..... | -1mA to +5mA | Storage Temperature Range..... | -65°C to +160°C |
| Current Range Into SDA | -1mA to +1mA | Lead Temperature (soldering, 10s) | +300°C |
| | | Soldering Temperature (reflow) | +260°C |

Stresses beyond those listed under "Absolute Maximum Ratings" may cause permanent damage to the device. These are stress ratings only, and functional operation of the device at these or any other conditions beyond those indicated in the operational sections of the specifications is not implied. Exposure to absolute maximum rating conditions for extended periods may affect device reliability.

ELECTRICAL CHARACTERISTICS

(VCC = 2.85V to 3.63V, CML receiver output is AC-coupled to differential 100Ω load, CCAZ = 0.1μF, TA = -40°C to +85°C. Registers are set to default values, unless otherwise noted. Typical values are at VCC = 3.3V, TA = +25°C, unless otherwise noted.)

| PARAMETER | SYMBOL | CONDITIONS | MIN | TYP | MAX | UNITS |
|--|-----------------|---|------|-------|--------|-------|
| POWER SUPPLY | | | | | | |
| Power-Supply Current | ICC | Includes the CML output current, VDIFF_ROUT = 400mVp-p, RXDE_EN = 0, LOS1_EN = 1, LOS2_EN = 0 | | 46.6 | 62 | mA |
| | | Includes the CML output current, VDIFF_ROUT = 400mVp-p, RXDE_EN = 0, LOS1_EN = 0, LOS2_EN = 1 | | 39.4 | 52.5 | |
| Power-Supply Voltage | VCC | | 2.85 | | 3.63 | V |
| Power-Supply Noise | | f < 10MHz | | | 100 | mVp-p |
| | | 10MHz < f < 20MHz | | | 10 | |
| GENERAL | | | | | | |
| Input Data Rate | | | 1.06 | 10.32 | 11.3 | Gbps |
| Input/Output SNR | | | 14.1 | | | |
| BER | | | | | 10E-12 | |
| POWER-ON RESET (POR) | | | | | | |
| POR Deassert Threshold | | | | 2.55 | 2.75 | V |
| POR Assert Threshold | | | 2.3 | 2.45 | | V |
| INPUT SPECIFICATIONS | | | | | | |
| Differential Input Resistance RIN+/RIN- | RIN_DIFF | | 75 | 100 | 125 | Ω |
| Input Sensitivity (Note 1) | VINMIN | RATE_SEL = 1, input transition time 25ps, 10.32Gbps, PRBS23-1 pattern | | 4 | 8 | mVp-p |
| | | RATE_SEL = 0, input transition time 260ps, 1.25Gbps, K28.5 pattern | | 1 | 2 | |
| Input Overload | VINMAX | | 1.2 | | | Vp-p |
| Input Return Loss | SDD11 | DUT is powered on, f ≤ 5GHz | | 10 | | dB |
| | | DUT is powered on, f ≤ 16GHz | | 7 | | |
| | SCC11 | DUT is powered on, 1GHz < f ≤ 5GHz | | 13 | | dB |
| | | DUT is powered on, 1GHz < f ≤ 16GHz | | 5 | | |
| RPMIN Input-Current High | I _{IH} | LOS1_EN = 0 and LOS2_EN = 1, VRPMIN = 2V | | 50 | | nA |

1.0625Gbps to 11.3Gbps, SFP+ Dual-Path Limiting Amplifier

MAX3945

ELECTRICAL CHARACTERISTICS (continued)

(V_{CC} = 2.85V to 3.63V, CML receiver output is AC-coupled to differential 100Ω load, C_{CAZ} = 0.1μF, T_A = -40°C to +85°C. Registers are set to default values, unless otherwise noted. Typical values are at V_{CC} = 3.3V, T_A = +25°C, unless otherwise noted.)

| PARAMETER | SYMBOL | CONDITIONS | MIN | TYP | MAX | UNITS |
|--|--------------------------------|--|-----|-----|------|-------------------|
| External R _P MIN Filter Capacitor | | | 100 | | | pF |
| OUTPUT SPECIFICATIONS | | | | | | |
| Differential Output Resistance R _{OUT+} /R _{OUT-} | R _{OUTDIFF} | | 75 | 100 | 125 | Ω |
| Output Return Loss | SDD22 | DUT is powered on, f ≤ 5GHz | | 13 | | dB |
| | | DUT is powered on, f ≤ 16GHz | | 7 | | |
| | SCC22 | DUT is powered on, 1GHz < f ≤ 5GHz | | 10 | | |
| | | DUT is powered on, 1GHz < f ≤ 16GHz | | 6 | | |
| Differential Output-Voltage High | | 5mV _{P-P} ≤ V _{IN} ≤ 1200mV _{P-P} , RATE_SEL = 0, SET_CML[7:0] = 169d (decimal) | 595 | 800 | 1005 | mV _{P-P} |
| | | 10mV _{P-P} ≤ V _{IN} ≤ 1200mV, RATE_SEL = 1, SET_CML[7:0] = 181d | 595 | 800 | 1005 | |
| Differential Output-Voltage Medium | | 10mV _{P-P} ≤ V _{IN} ≤ 1200mV _{P-P} , RATE_SEL = 1, SET_CML[7:0] = 91d | 300 | 400 | 515 | mV _{P-P} |
| SET_CML DAC Range | | | 60 | | 255 | Decimal |
| Differential Output Signal When Squelched (Note 1) | | Outputs AC-coupled, SET_CML[7:0] = 181d, at 8.5Gbps, SQ_EN = 1 | | 6 | 15 | mV _{P-P} |
| Data Output Transition Time (20% to 80%) (Note 1) | t _R /t _F | 60mV _{P-P} ≤ V _{IN} ≤ 400mV _{P-P} at 10.32Gbps, RATE_SEL = 1, V _{DIFF_ROUT} = 400mV _{P-P} , RXDE_EN = 0, input transition time 25ps, pattern 11110000 | | 26 | 35 | ps |
| | | 10mV _{P-P} ≤ V _{IN} ≤ 1200mV _{P-P} at 1.25Gbps, RATE_SEL = 0, V _{DIFF_ROUT} = 800mV _{P-P} , input transition time 260ps, pattern 11110000 | | 52 | 90 | |
| TRANSFER CHARACTERISTICS | | | | | | |
| Deterministic Jitter (Notes 1, 2) | DJ | 10mV _{P-P} ≤ V _{IN} ≤ 1200mV _{P-P} at 8.5Gbps, RATE_SEL = 1, V _{DIFF_ROUT} = 400mV _{P-P} , RXDE_EN = 0, input transition time 28ps | | 4 | 8 | pSP-P |
| | | 60mV _{P-P} ≤ V _{IN} ≤ 400mV _{P-P} at 10.32Gbps, RATE_SEL = 1, V _{DIFF_ROUT} = 400mV _{P-P} , RXDE_EN = 0, input transition time 28ps | | 4 | 9 | |
| | | 60mV _{P-P} ≤ V _{IN} ≤ 400mV _{P-P} at 11.3Gbps, RATE_SEL = 1, V _{DIFF_ROUT} = 400mV _{P-P} , RXDE_EN = 0, input transition time 28ps | | 4 | 9 | |
| | | 10mV _{P-P} ≤ V _{IN} ≤ 1200mV _{P-P} at 1.25Gbps, RATE_SEL = 0, BW1 = 0, BW0 = 0, V _{DIFF_ROUT} = 800mV _{P-P} , input transition time 260ps | | 9 | 30 | |
| | | 10mV _{P-P} ≤ V _{IN} ≤ 1200mV _{P-P} at 4.25Gbps, RATE_SEL = 0, BW1 = 1, BW0 = 1, V _{DIFF_ROUT} = 800mV _{P-P} , input transition time 28ps | | 5 | 10 | |

1.0625Gbps to 11.3Gbps, SFP+ Dual-Path Limiting Amplifier

ELECTRICAL CHARACTERISTICS (continued)

(V_{CC} = 2.85V to 3.63V, CML receiver output is AC-coupled to differential 100Ω load, CCAZ = 0.1μF, T_A = -40°C to +85°C. Registers are set to default values, unless otherwise noted. Typical values are at V_{CC} = 3.3V, T_A = +25°C, unless otherwise noted.)

| PARAMETER | SYMBOL | CONDITIONS | MIN | TYP | MAX | UNITS |
|---|------------------|---|------|------|------|-------------------|
| Random Jitter (Note 1) | RJ | Input = 60mV _{P-P} at 10.32Gbps, RATE_SEL = 1, RXDE_EN = 0, input transi- tion time 28ps, pattern 11110000, V _{DIFF_ROUT} = 800mV _{P-P} | | 0.28 | 0.51 | psRMS |
| Low-Frequency Cutoff (Simulated Value) | | RATE_SEL = 0, CCAZ = 0.1μF | | 2 | | kHz |
| | | RATE_SEL = 1, CCAZ = 0.1μF | | 0.7 | | |
| Small-Signal Bandwidth (Simulated Value) | f _{3dB} | RATE_SEL = 0, BW1 = 0, BW0 = 0 | | 1.0 | | GHz |
| | | RATE_SEL = 0, BW1 = 0, BW0 = 1 | | 2.1 | | |
| | | RATE_SEL = 0, BW1 = 1, BW0 = 0 | | 2.5 | | |
| | | RATE_SEL = 0, BW1 = 1, BW0 = 1 | | 3.0 | | |
| | | RATE_SEL = 1 | | 9 | | |
| Rx INPUT-BASED LOS SPECIFICATIONS (LOS1_EN = 1 and LOS2_EN = 0) (Note 1) | | | | | | |
| LOS Assert Sensitivity Range | | (Note 3) | 14 | | 77 | mV _{P-P} |
| SET_LOS DAC Range | | | 7 | | 63 | Decimal |
| LOS Hysteresis | | 10log(V _{DEASSERT} /V _{ASSERT}) | 1.25 | 2.1 | | dB |
| LOS Assert/Deassert Time | | (Note 4) | 2.3 | 20 | 80 | μs |
| Low Assert Level | | SET_LOS[5:0] = 7d (Note 3) | 8 | 11 | 14 | mV _{P-P} |
| Low Deassert Level | | | 14 | 18 | 22 | |
| Medium Assert Level | | SET_LOS[5:0] = 32d (Note 3) | 39 | 49 | 58 | mV _{P-P} |
| Medium Deassert Level | | | 65 | 82 | 95 | |
| High Assert Level | | SET_LOS[5:0] = 63d (Note 3) | 77 | 96 | 112 | mV _{P-P} |
| High Deassert Level | | | 127 | 158 | 182 | |
| LOS Output Masking Time Range | | SET_LOSTIMER[6:0] = 0d for minimum and SET_LOSTIMER[6:0] = 127d for maximum | 0 | | 2920 | μs |
| LOS Output Masking DAC Resolution | | SET_LOSTIMER[6:0] = 1d to 127d | 23 | 35 | 50 | μs |
| RSSI MONITOR-BASED LOS SPECIFICATIONS (LOS1_EN = 0 and LOS2_EN = 1) (Note 1) | | | | | | |
| LOS Assert Sensitivity Range | | (Note 5) | 8.3 | | 90 | mV |
| SET_LOS DAC Range | | | 4 | | 63 | Decimal |
| LOS Hysteresis | | 10log(V _{DEASSERT} /V _{ASSERT}) | 1.25 | 2.1 | | dB |
| LOS Assert/Deassert Time | | (Note 4) | 2.3 | 20 | 80 | μs |
| Low Assert Level | | SET_LOS[5:0] = 4d (Note 5) | 5.1 | 6.7 | 8.3 | mV |
| Low Deassert Level | | | 9.0 | 10.8 | 12.7 | |
| Medium Assert Level | | SET_LOS[5:0] = 32d (Note 5) | 45 | 50 | 55 | mV |
| Medium Deassert Level | | | 77 | 85 | 92 | |
| High Assert Level | | SET_LOS[5:0] = 63d (Note 5) | 90 | 98 | 106 | mV |
| High Deassert Level | | | 153 | 167 | 180 | |
| LOS Output Masking Time Range | | SET_LOSTIMER[6:0] = 0d for minimum and SET_LOSTIMER[6:0] = 127d for maximum | 0 | | 2920 | μs |
| LOS Output Masking DAC Resolution | | SET_LOSTIMER[6:0] = 1d to 127d | 23 | 35 | 50 | μs |

1.0625Gbps to 11.3Gbps, SFP+ Dual-Path Limiting Amplifier

MAX3945

ELECTRICAL CHARACTERISTICS (continued)

(V_{CC} = 2.85V to 3.63V, CML receiver output is AC-coupled to differential 100Ω load, C_{CAZ} = 0.1μF, T_A = -40°C to +85°C. Registers are set to default values, unless otherwise noted. Typical values are at V_{CC} = 3.3V, T_A = +25°C, unless otherwise noted.)

| PARAMETER | SYMBOL | CONDITIONS | MIN | TYP | MAX | UNITS |
|---|--------------------|--|-----|-----------------------|-----------------|-------------------|
| OUTPUT LEVEL VOLTAGE DAC (SET_CML) | | | | | | |
| Full-Scale Voltage | V _{FS} | 100Ω differential resistive load, RXDE_EN = 0 | | 1192 | | mV _{P-P} |
| | | 100Ω differential resistive load, RATE_SEL = 1, RXDE_EN = 1, RXDE1 = 1, RXDE0 = 1 (maximum deemphasis) | | 828 | | |
| Resolution | | 100Ω differential resistive load, RXDE_EN = 0 | | 4.5 | | mV _{P-P} |
| | | 100Ω differential resistive load, RATE_SEL = 1, RXDE_EN = 1, RXDE1 = 1, RXDE0 = 1 (maximum deemphasis) | | 3.3 | | |
| Integral Nonlinearity | INL | SET_CML[7:0] > 60d | | ±0.9 | | LSB |
| LOS THRESHOLD VOLTAGE DAC (SET_LOS) | | | | | | |
| Full-Scale Voltage | V _{FS} | LOS1_EN = 1, LOS2_EN = 0 | | 96 | | mV _{P-P} |
| | | LOS1_EN = 0, LOS2_EN = 1 | | 98 | | mV |
| Resolution | | LOS1_EN = 1, LOS2_EN = 0 | | 1.52 | | mV _{P-P} |
| | | LOS1_EN = 0, LOS2_EN = 1 | | 1.56 | | mV |
| Integral Nonlinearity | INL | SET_LOS[5:0] > 3d | | ±0.7 | | LSB |
| CONTROL I/O SPECIFICATIONS | | | | | | |
| LOS Output High Voltage | V _{OH} | R _{LOS} = 4.7kΩ to 10kΩ to V _{CC} | | V _{CC} - 0.5 | V _{CC} | V |
| LOS Output Low Voltage | V _{OL} | R _{LOS} = 4.7kΩ to 10kΩ to V _{CC} | 0 | | 0.4 | V |
| 3-WIRE DIGITAL I/O SPECIFICATIONS (SDA, CSEL, SCL) | | | | | | |
| Input High Voltage | V _{IH} | | 2.0 | | V _{CC} | V |
| Input Low Voltage | V _{IL} | | | | 0.8 | V |
| Input Hysteresis | V _{HYST} | | | 0.082 | | V |
| Input Leakage Current | I _{I, IH} | V _{IN} = 0V or V _{CC} , internal pullup or pulldown (75kΩ typ) | | | 85 | μA |
| Output High Voltage | V _{OH} | External pullup of 4.7kΩ to V _{CC} | | V _{CC} - 0.5 | V _{CC} | V |
| Output Low Voltage | V _{OL} | External pullup of 4.7kΩ to V _{CC} | 0 | | 0.4 | V |
| 3-WIRE DIGITAL INTERFACE TIMING CHARACTERISTICS (see Figure 5) | | | | | | |
| SCL Clock Frequency | f _{SCL} | | 0 | 400 | 1000 | kHz |
| SCL Pulse-Width High | t _{CH} | | 500 | | | ns |
| SCL Pulse-Width Low | t _{CL} | | 500 | | | ns |
| SDA Setup Time | t _{DS} | | | 100 | | ns |
| SDA Hold Time | t _{DH} | | | 100 | | ns |
| SCL Rise to SDA Propagation Time | t _D | | | 5 | | ns |
| CSEL Pulse-Width Low | t _{CSW} | | 500 | | | ns |

1.0625Gbps to 11.3Gbps, SFP+ Dual-Path Limiting Amplifier

ELECTRICAL CHARACTERISTICS (continued)

(V_{CC} = 2.85V to 3.63V, CML receiver output is AC-coupled to differential 100Ω load, C_{CAZ} = 0.1μF, T_A = -40°C to +85°C. Registers are set to default values, unless otherwise noted. Typical values are at V_{CC} = 3.3V, T_A = +25°C, unless otherwise noted.)

| PARAMETER | SYMBOL | CONDITIONS | MIN | TYP | MAX | UNITS |
|---|----------------|---|-----|-----|-----|-------|
| CSEL Leading Time Before the First SCL Edge | t _L | | | 500 | | ns |
| CSEL Trailing Time After the Last SCL Edge | t _T | | | 500 | | ns |
| SDA, SCL External Load | C _B | Total bus capacitance on one line with 4.7kΩ to V _{CC} | | | 20 | pF |

Note 1: Guaranteed by design and characterization, T_A = -40°C to +95°C.

Note 2: Deterministic jitter is measured with a repeating K28.5 pattern [00111110101100000101] for 1.25Gbps to 8.5Gbps data. At 10.32Gbps and 11.3Gbps, a repeating K28.5 plus 59 0s and K28.5 plus 59 1s pattern is used. Deterministic jitter is defined as the arithmetic sum of pulse-width distortion (PWD) and pattern-dependent jitter (PDJ).

Note 3: LOS1_EN = 1, data rates of 1.25Gbps to 8.5Gbps with K28.5 pattern, and 6.4GHz input filter. For data rates of 10.32Gbps to 11.3Gbps, the input filter is 12.5GHz and the pattern is PRBS23-1.

Note 4: Measurement includes an input AC-coupling capacitor of 100nF and C_{CAZ} of 100nF. The signal at the RIN or RPMIN input is switched between two amplitudes: Signal_ON and Signal_OFF.

1) Receiver operates at sensitivity level plus 1dB power penalty

a) Signal_OFF = 0

Signal_ON = (+8dB) + 10log(min_assert_level)

b) Signal_ON = (+1dB) + 10log(max_deassert_level)

Signal_OFF = 0

2) Receiver operates at overload

Signal_OFF = 0

Signal_ON = 1.2Vp-p

max_deassert_level and min_assert_level are measured for one SET_LOS setting

Note 5: LOS1_EN = 0, LOS2_EN = 1, DC voltage applied to the RPMIN input.

1.0625Gbps to 11.3Gbps, SFP+ Dual-Path Limiting Amplifier

Typical Operating Characteristics

(VCC = 3.3V, TA = +25°C, unless otherwise noted. Registers are set to default values, unless otherwise noted, and the 3-wire interface is static during measurements.)

**RECEIVE OUTPUT FROM OPTICAL SYSTEM,
10.32Gbps, OPTICAL INPUT -10dBm,
RXDE1 = 1, RXDE0 = 0**

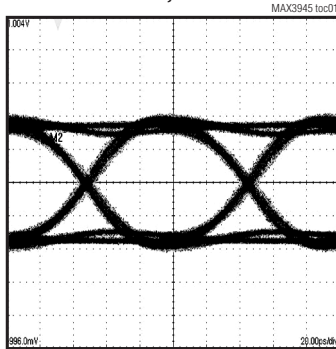

**RECEIVE OUTPUT FROM OPTICAL SYSTEM,
10.32Gbps, OPTICAL INPUT -15dBm,
RXDE1 = 1, RXDE0 = 0**

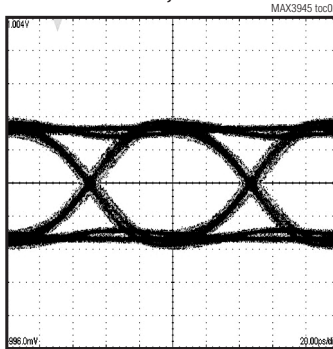

**RECEIVE OUTPUT FROM OPTICAL SYSTEM,
10.32Gbps, OPTICAL INPUT -20dBm,
RXDE1 = 1, RXDE0 = 0**

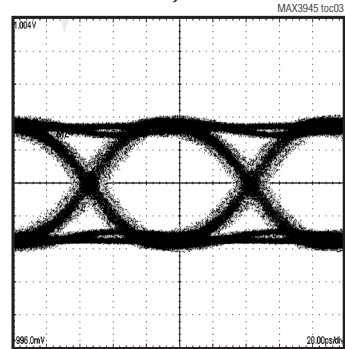

OPTICAL BER CURVES (NEC NR3312)

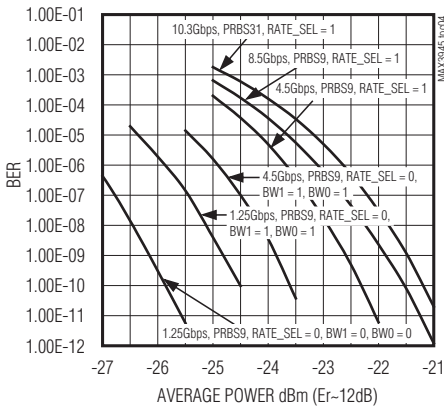

**K28.5 PATTERN AT 1.25Gbps,
SET_CML[7:0] = 169d,
RATE_SEL = 0, BWO = 0, BW1 = 0**

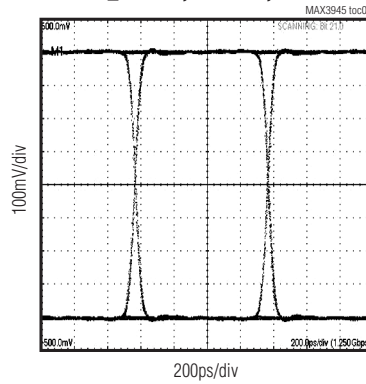

**K28.5 PATTERN AT 4.25Gbps,
SET_CML[7:0] = 169d,
RATE_SEL = 0, BWO = 1, BW1 = 1**

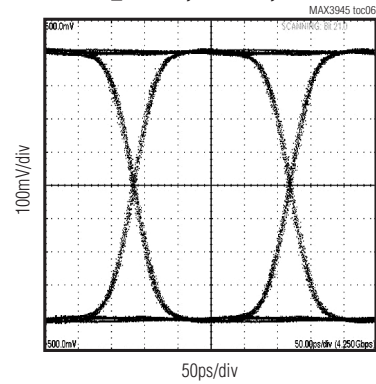

**K28.5 PATTERN AT 8.5Gbps, SET_CML[7:0] = 148d,
RATE_SEL = 1, RXDE_EN = 0**

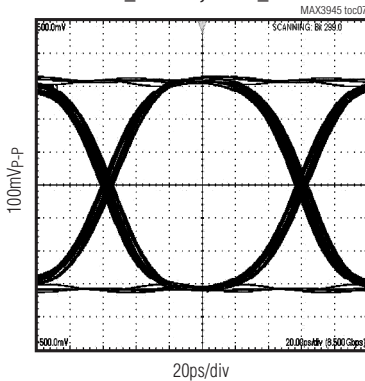

**K28.5 PATTERN AT 10.3Gbps,
SET_CML[7:0] = 148d,
RATE_SEL = 1, RXDE_EN = 0**

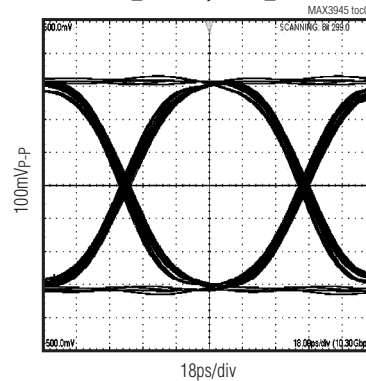

**K28.5 PATTERN AT 11.3Gbps,
SET_CML[7:0] = 148d,
RATE_SEL = 1, RXDE_EN = 0**

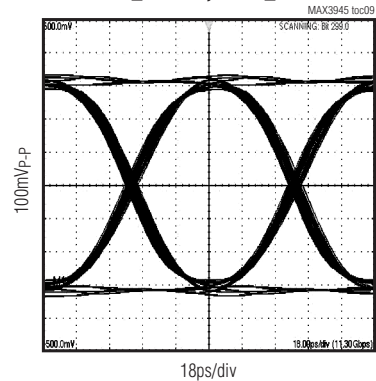

1.0625Gbps to 11.3Gbps, SFP+ Dual-Path Limiting Amplifier

Typical Operating Characteristics (continued)

($V_{CC} = 3.3V$, $T_A = +25^\circ C$, unless otherwise noted. Registers are set to default values, unless otherwise noted, and the 3-wire interface is static during measurements.)

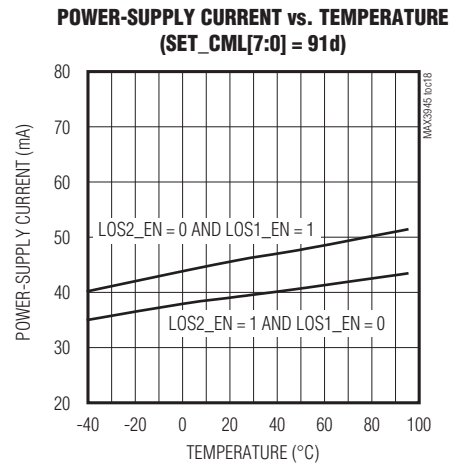
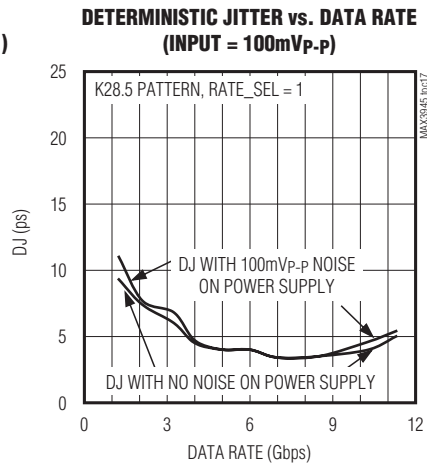
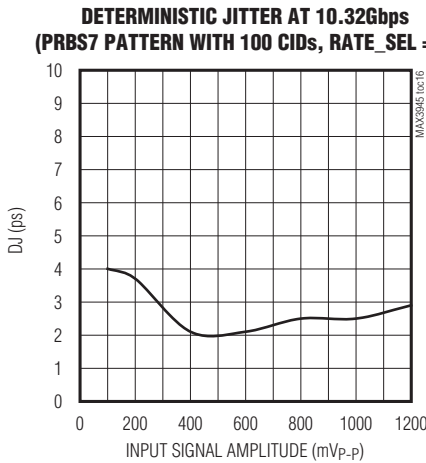
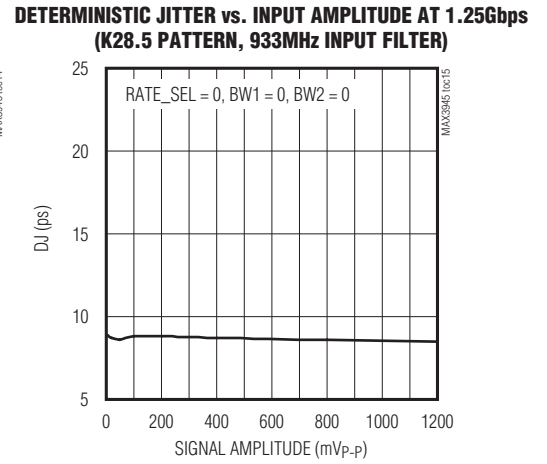
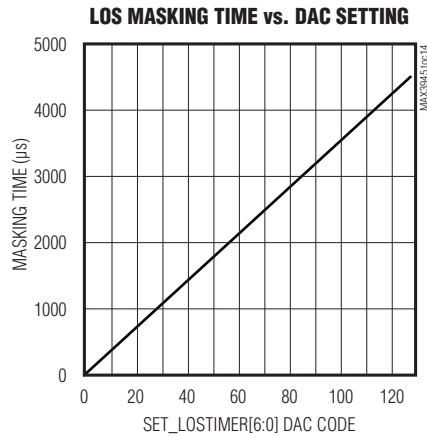
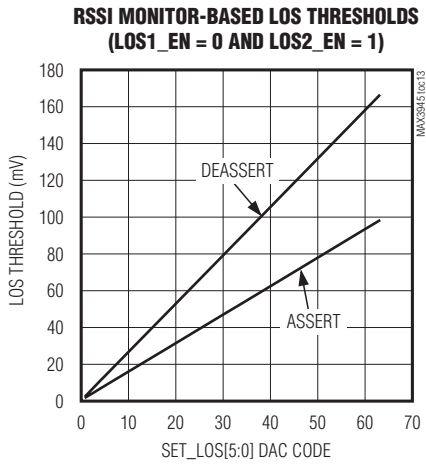
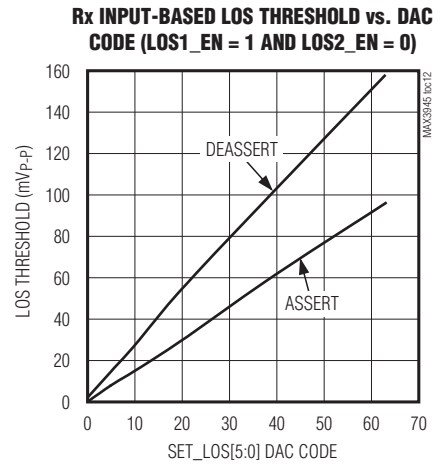
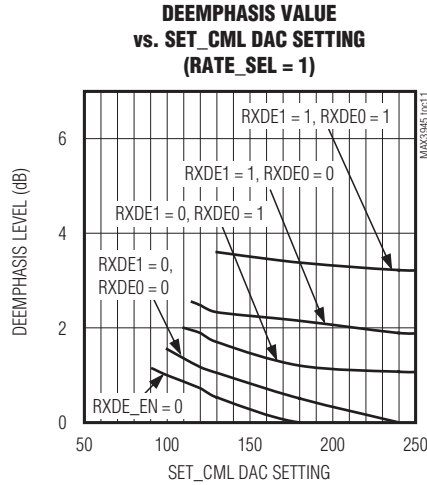
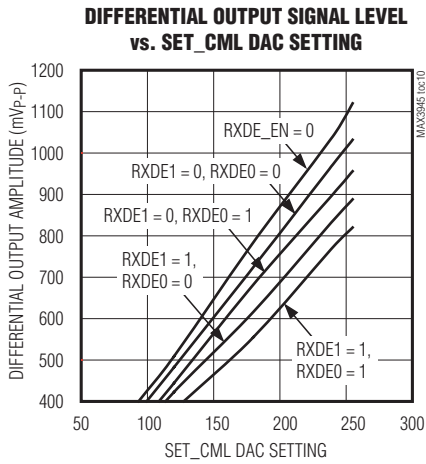

1.0625Gbps to 11.3Gbps, SFP+ Dual-Path Limiting Amplifier

Typical Operating Characteristics (continued)

(VCC = 3.3V, TA = +25°C, unless otherwise noted. Registers are set to default values, unless otherwise noted, and the 3-wire interface is static during measurements.)

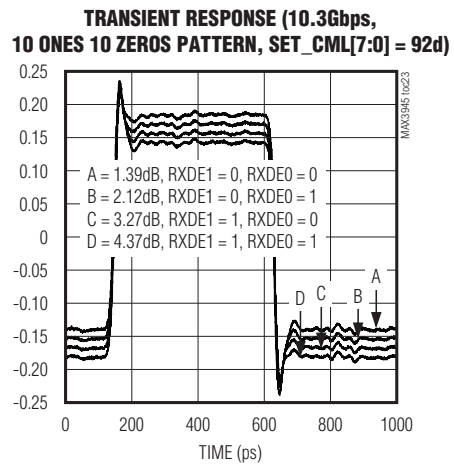
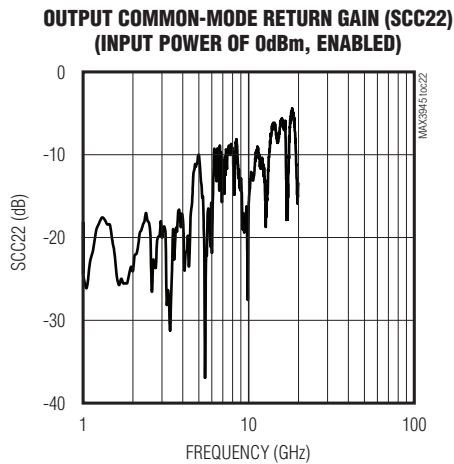
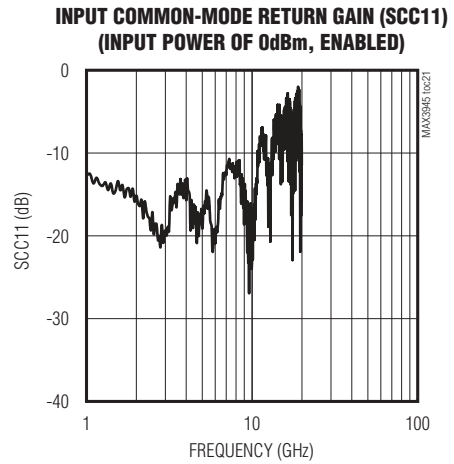
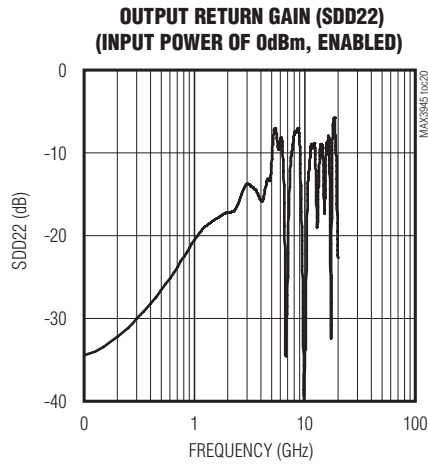
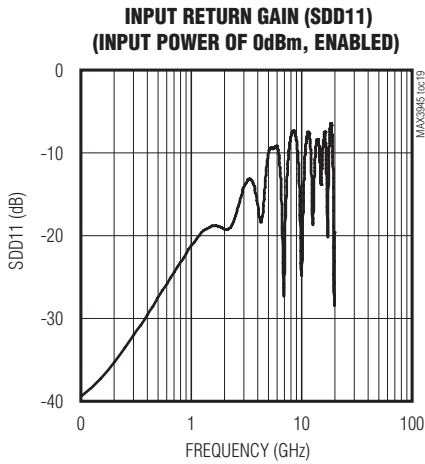

**ELECTRICAL EYE DIAGRAM AFTER 6in OF FR4
AND 72in OF CABLE WITH NO DEEMPHASIS (11.3Gbps K28.5,
RATE_SEL = 1, SET_CML[7:0] = 160d, RXDE_EN = 0)**

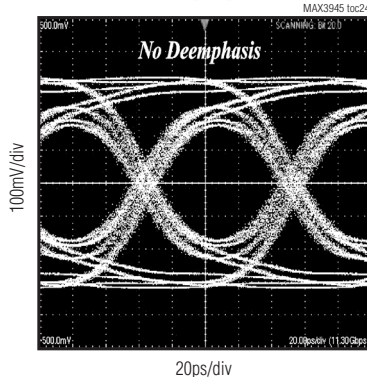

**ELECTRICAL EYE DIAGRAM AFTER 6in OF FR4
AND 72in OF CABLE WITH DEEMPHASIS (11.3Gbps K28.5, RATE_SEL = 1,
SET_CML[7:0] = 160d, RXDE_EN = 1, RXDE0 = 1, RXDE1 = 1)**

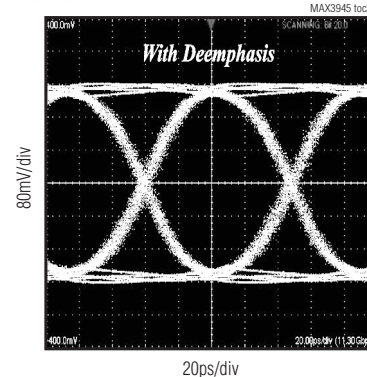

1.0625Gbps to 11.3Gbps, SFP+ Dual-Path Limiting Amplifier

Pin Configuration

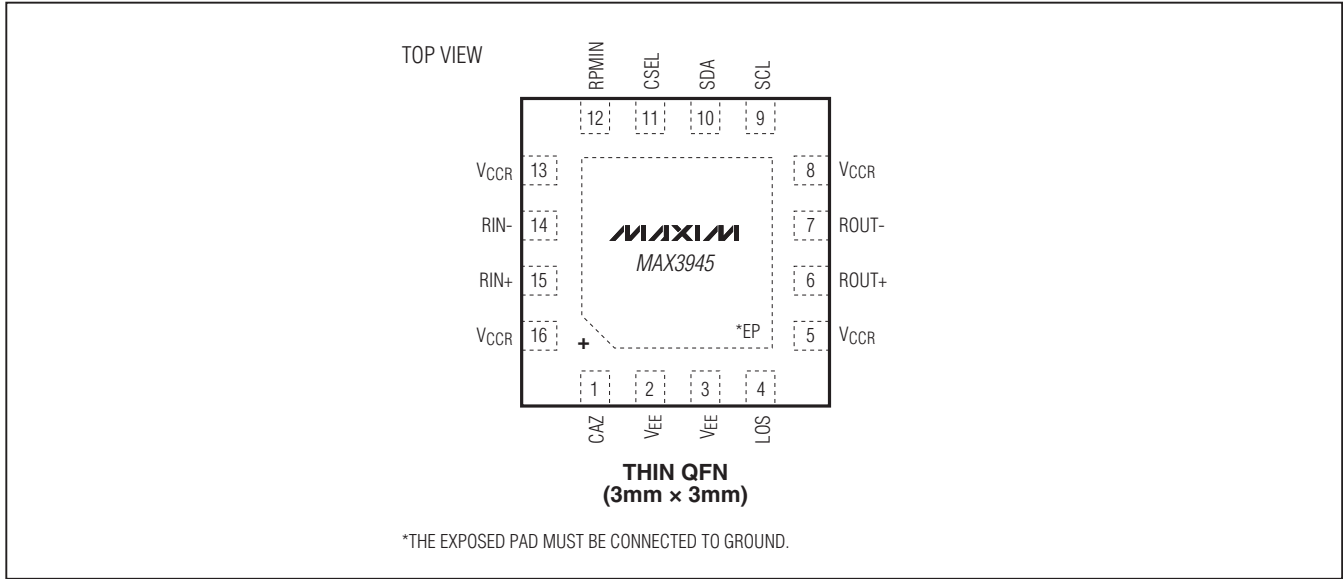

Pin Description

| PIN | NAME | FUNCTION |
|--------------|-------|--|
| 1 | CAZ | Offset-Correction Loop Capacitor. A capacitor connected between this pin and the adjacent VEE pin sets the time constant of the offset-correction loop. The offset correction can be disabled through the digital interface by setting bit AZ_EN = 0 and by connecting this pin to ground. |
| 2, 3 | VEE | Ground for Limiting Amplifier |
| 4 | LOS | Loss-of-Signal Output. This output is an open-drain output. LOS is asserted when the level of the input signal drops below the preset threshold set by SET_LOS[5:0]. LOS is deasserted when the signal level is above the threshold. The polarity of the LOS output can be inverted by setting LOS_POL = 0. The LOS circuitry can be disabled by setting LOS1_EN = 0 and LOS2_EN = 0. See Table 8. |
| 5, 8, 13, 16 | VCCR | Power Supply. Provides supply voltage to the limiting amplifier. All pins must be connected to the supply voltage. |
| 6 | ROUT+ | Noninverted Output, CML. Back terminated for 50Ω load. |
| 7 | ROUT- | Inverted Output, CML. Back terminated for 50Ω load. |
| 9 | SCL | Serial-Clock Input, TTL/CMOS. This pin has a 75kΩ internal pull-down. |
| 10 | SDA | Serial-Data Bidirectional I/O. TTL/CMOS input and open-drain output. This pin has a 75kΩ internal pull-up, but it requires an external 4.7kΩ pullup resistor to meet the 3-wire digital timing specification. (Data line collision protection is implemented.) |
| 11 | CSEL | Chip-Select Input, TTL/CMOS. Internally pulled down by a 75kΩ resistor. CSEL = 1 starts an SPI cycle, while CSEL = 0 ends the SPI cycle and resets the control state machine. |
| 12 | RPMIN | High-Impedance Receive Power-Monitor Input. Connect to ground when not used. |
| 14 | RIN- | Inverted Data Input, CML, with 50Ω Termination |
| 15 | RIN+ | Noninverted Data Input, CML, with 50Ω Termination |
| — | EP | Exposed Pad. Must be soldered to circuit ground. |

1.0625Gbps to 11.3Gbps, SFP+ Dual-Path Limiting Amplifier

Detailed Description

The MAX3945 is designed to operate from 1.0625Gbps to 11.3Gbps. It consists of a dual-path limiter, offset-correction circuitry, CML output stage, and LOS circuitry. The characteristics of the MAX3945 can be controlled through the on-chip 3-wire interface. The registers that control the part's functionality are RXCTRL1, RXCTRL2, RXSTAT, SET_CML, SET_LOS, MODECTRL, and SET_LOSTIMER. The MAX3945 provides integrated DACs to allow the use of low-cost controller ICs. Figure 1 shows simplified input and output structures.

Dual-Path Limiter

The limiting amplifier features a low data-rate path (1.0625Gbps to 4.25Gbps) and a high data-rate path (up to 11.3Gbps), allowing for overall system optimization. Figure 2 shows the functional diagram. Data path selection is controlled by the RATE_SEL bit. The low data-rate path further features a programmable filter that provides optimization for 1.0625Gbps, 1.25Gbps, 2.125Gbps, and 4.25Gbps operation. It is important to tailor the bandwidth of the first stages to get the best receive sensitivity and to reduce the maximum receive

bandwidth for a given data rate. Table 1 summarizes the RATE_SEL, BW1, and BW0 control bit functions. The high data-rate mode (RATE_SEL = 1) is recommended for operation up to 11.3Gbps.

The polarity of ROUT+/ROUT- relative to RIN+/RIN- is programmed by the RX_POL bit, as shown in Table 2.

Offset-Correction Circuitry

The offset-correction circuitry is provided to remove PWD caused by intrinsic offset voltages within the differential amplifier stages. An external 0.1 μ F capacitor connected between the CAZ pin and ground sets the offset-correction loop cutoff frequency to approximately 2kHz when RATE_SEL = 0 and to approximately 0.7kHz when RATE_SEL = 1. The offset-correction loop can be disabled using the AZ_EN bit, as shown in Table 3.

CML Output Stage

CML Output Enable and Squelch

The CML output stage is optimized for differential 100 Ω loads. The output stage is controlled by a combination of the RX_EN and SQ_EN bits and the internal LOS status. See Table 4.

Table 1. Rate Select and Bandwidth Control

| RXCTRL1[3:1] | | | OPERATION MODE DESCRIPTION | | |
|--------------|-----|----------|----------------------------|------------------------|---------------------|
| BW1 | BW0 | RATE_SEL | DATA RATE (Gbps) | FILTER BANDWIDTH (MHz) | RISE/FALL TIME (ps) |
| 0 | 0 | 0 | 1.0625 to 1.25 | 1000 | 52 |
| 0 | 1 | 0 | 2.125 | 2100 | 52 |
| 1 | 0 | 0 | 2.125 | 2500 | 52 |
| 1 | 1 | 0 | 4.25 | 3000 | 52 |
| X | X | 1 | 11.3 | 9000 | 26 |

Table 2. Signal Polarity Control

| RX_POL | OPERATION MODE DESCRIPTION |
|--------|---|
| 0 | Inversed polarity of the differential signal path |
| 1 | Normal polarity of the differential signal path |

Table 3. Offset-Correction Enable/Disable Control

| AZ_EN | OPERATION MODE DESCRIPTION |
|-------|----------------------------|
| 0 | Autozero loop is disabled |
| 1 | Autozero loop is enabled |

Table 4. CML Output Stage Operation Modes

| RX_EN | SQ_EN | LOS STATUS | OPERATION MODE DESCRIPTION |
|-------|-------|------------|----------------------------|
| 0 | X | X | CML output disabled |
| 1 | 0 | X | CML output enabled |
| 1 | 1 | 0 | CML output enabled |
| 1 | 1 | 1 | CML output disabled |

1.0625Gbps to 11.3Gbps, SFP+ Dual-Path Limiting Amplifier

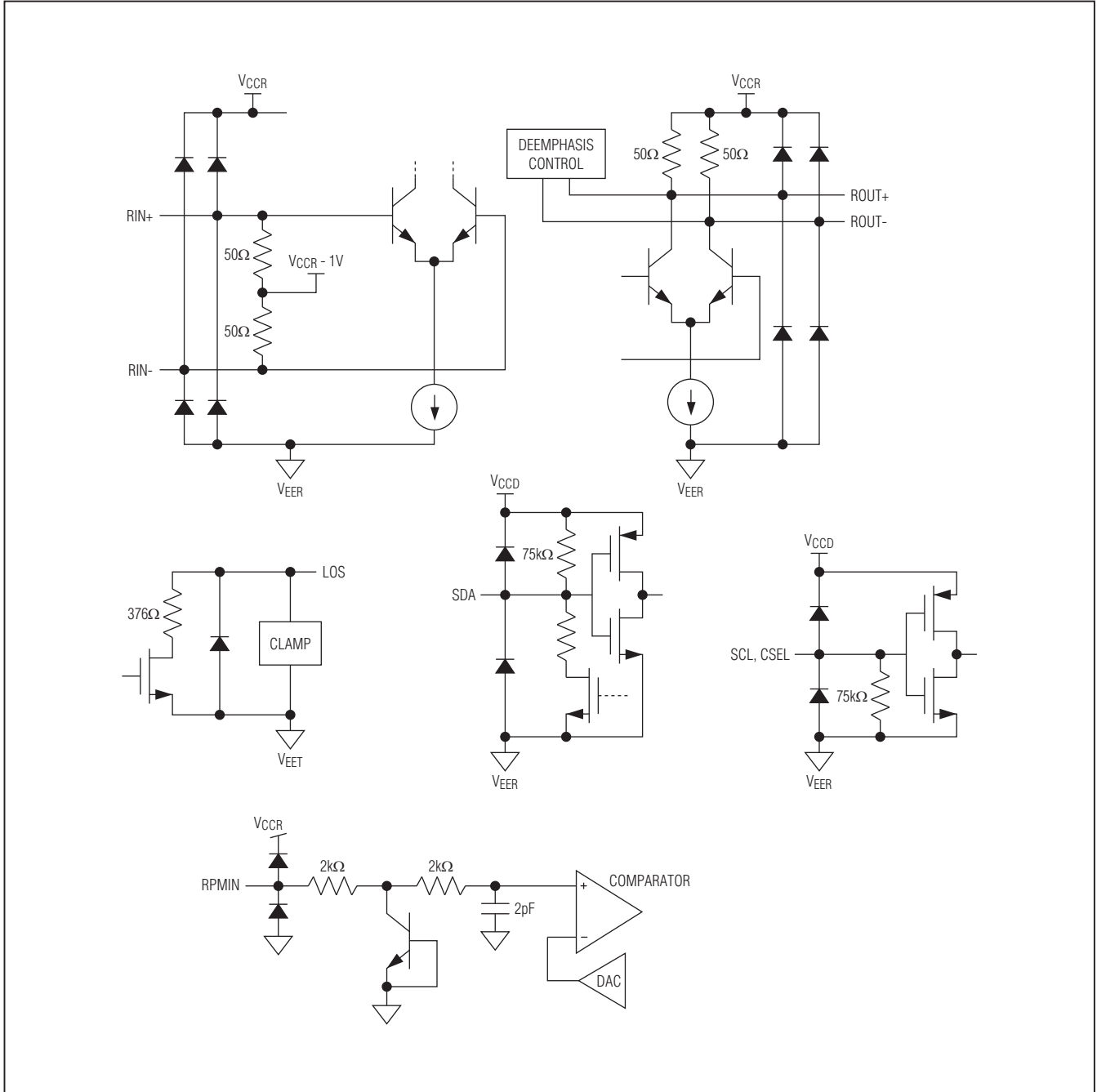

Figure 1. Simplified Input/Output Structures

1.0625Gbps to 11.3Gbps, SFP+ Dual-Path Limiting Amplifier

MAX3945

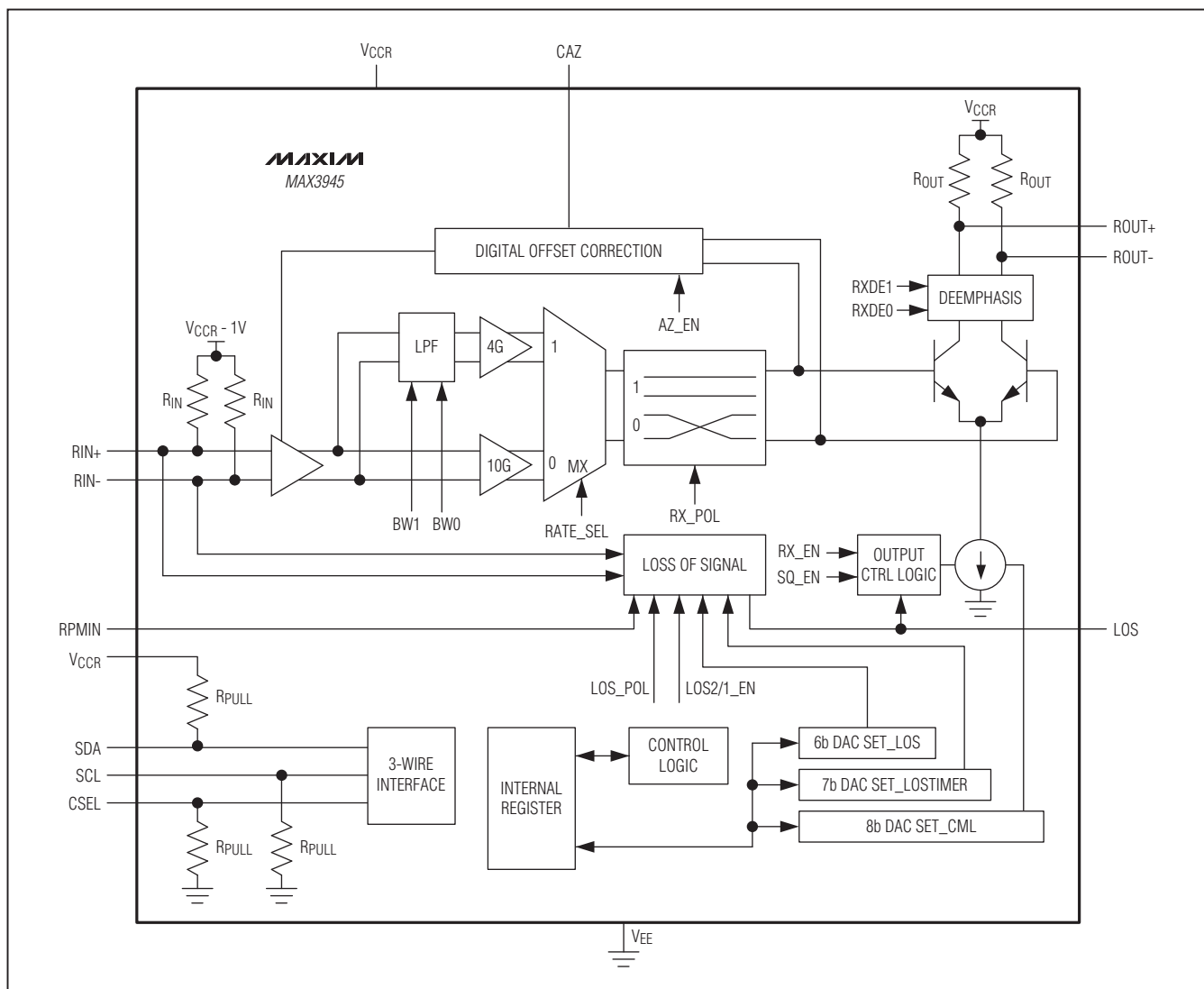

Figure 2. Functional Diagram

CML Output Deemphasis

The CML output stage is optimized for differential 100Ω transmission lines on a standard FR4 board. The RXDE1 and RXDE0 bits add programmable analog output deemphasis to compensate for FR4 board losses and SFP connector losses. Table 5 describes the deemphasis control settings.

Programmable CML Output Amplitude

The 8-bit SET_CML register controls the amplitude of the CML output stage. The maximum programmable output level depends on the operational mode of the MAX3945. These output levels (which assume an ideal 100Ω differential load) and their corresponding control bits are described in Table 6. Table 7 shows the output DAC resolution dependency.

1.0625Gbps to 11.3Gbps, SFP+ Dual-Path Limiting Amplifier

Table 5. Output Signal Deemphasis Control

| RXCTRL2[1] | RXCTRL1[7:6] | | OPERATION MODE DESCRIPTION | |
|------------|--------------|-------|-------------------------------------|-----------------|
| RXDE_EN | RXDE1 | RXDE0 | MODE | DEEMPHASIS (dB) |
| 0 | X | X | Deemphasis block is disabled | 0 |
| 1 | 0 | 0 | Deemphasis block is enabled Level 1 | 0.3 |
| 1 | 0 | 1 | Deemphasis block is enabled Level 2 | 1.1 |
| 1 | 1 | 0 | Deemphasis block is enabled Level 3 | 2.1 |
| 1 | 1 | 1 | Deemphasis block is enabled Level 4 | 4.3 |

Table 6. CML Output Amplitude Range (Typical)

| RXCTRL1[1] | RXCTRL2[1] | RXCTRL1[7:6] | | MODE | OUTPUT AMPLITUDE (mVp-p) |
|------------|------------|--------------|-------|-------------------------------------|--------------------------|
| RATE_SEL | RXDE_EN | RXDE1 | RXDE0 | | |
| 0 | X | X | X | Low data-rate path | 400 to 1192 |
| 1 | 0 | X | X | High data-rate path | 400 to 1147 |
| 1 | 1 | 0 | 0 | High data-rate path with deemphasis | 400 to 1041 |
| 1 | 1 | 0 | 1 | High data-rate path with deemphasis | 400 to 987 |
| 1 | 1 | 1 | 0 | High data-rate path with deemphasis | 400 to 908 |
| 1 | 1 | 1 | 1 | High data-rate path with deemphasis | 400 to 828 |

Table 7. CML Output DAC Resolution (Typical)

| RXCTRL1[1] | RXCTRL2[1] | RXCTRL1[7:6] | | MODE | RESOLUTION (mVp-p) |
|------------|------------|--------------|-------|-------------------------------------|--------------------|
| RATE_SEL | RXDE_EN | RXDE1 | RXDE0 | | |
| 0 | X | X | X | Low data-rate path | 4.5 |
| 1 | 0 | X | X | High data-rate path | 4.5 |
| 1 | 1 | 0 | 0 | High data-rate path with deemphasis | 4.1 |
| 1 | 1 | 0 | 1 | High data-rate path with deemphasis | 3.9 |
| 1 | 1 | 1 | 0 | High data-rate path with deemphasis | 3.6 |
| 1 | 1 | 1 | 1 | High data-rate path with deemphasis | 3.3 |

1.0625Gbps to 11.3Gbps, SFP+ Dual-Path Limiting Amplifier

Table 8. LOS Control

| LOS2_EN | LOS1_EN | OPERATION MODE DESCRIPTION |
|---------|---------|--|
| 0 | 0 | LOS circuitry is disabled and powered down |
| X | 1 | LOS circuitry is enabled and Rx input amplitude is detected |
| 1 | 0 | LOS circuitry is enabled and RPMIN input amplitude is detected |

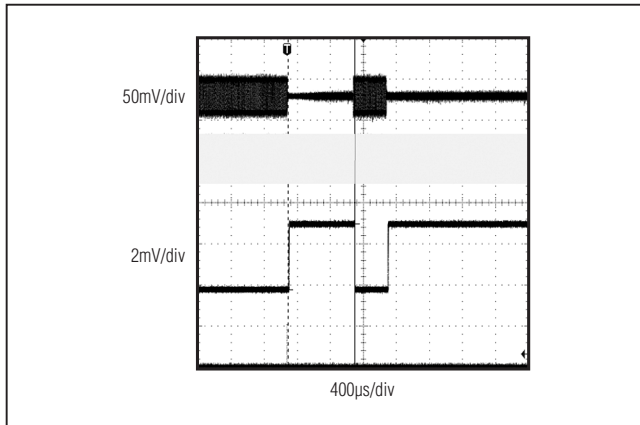

Figure 3. LOS Response to a Short Burst of Input Signal

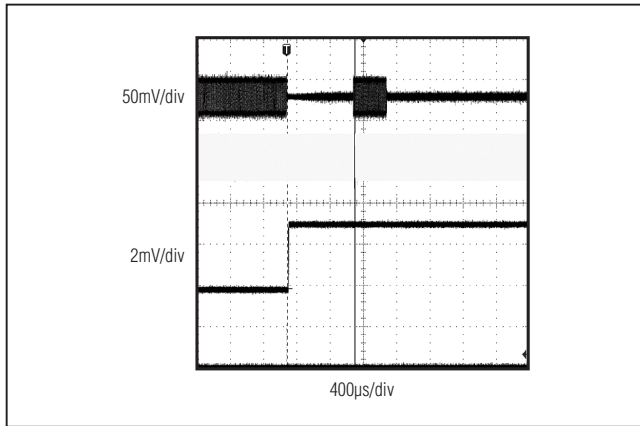

Figure 4. LOS Response to a Short Burst of Input Signal (Any changes in LOS are masked until the end of the LOS masking period.)

LOS Circuitry

The LOS circuitry has two operational modes controlled by the LOS1_EN and LOS2_EN bits (see Table 8). In the first mode, the LOS block detects the differential amplitude of the input signal and compares it against a preset threshold controlled by the 6-bit SET_LOS register. In the second mode, the LOS block compares the voltage at the RPMIN pin to a preset threshold also controlled by the 6-bit SET_LOS register. The second mode enables low-power LOS detection based on average photodiode current.

The LOS assert threshold is approximately $1.5\text{mV}_{\text{P-P}} \times \text{SET_LOS}[5:0]$. The LOS deassert level is approximately 1.6 times the assert level to avoid LOS chatter. LOS polarity, squelch, and LOS masking time are unaffected by the selection of LOS1_EN or LOS2_EN.

Programmable LOS Output Masking Time

This feature masks false input signals that can occur after a loss-of-light event in a fiber optic link. These false input signals, caused by some transimpedance amplifier implementations, can corrupt the LOS output and cause system-level link diagnostic errors.

The LOS output masking time can be programmed from 0 to $4500\mu\text{s}$ in $35\mu\text{s}$ steps using the 7-bit SET_LOSTIMER[6:0] register. The output mask timer is initiated on the first transition of the LOS signal and prevents any further changes in the LOS output signal until the end of the programmed LOS timing period. The LOS output masking time should be carefully chosen to extend beyond any expected input glitch. Figure 3 shows the LOS signal changing after approximately $800\mu\text{s}$ to a change in the input signal where the LOS output masking time function is not used. Figure 4 shows masking of the LOS signal by the LOS output masking time function to a change in the input signal.

1.0625Gbps to 11.3Gbps, SFP+ Dual-Path Limiting Amplifier

Table 9. Digital Communication Word Structure

| BIT | | | | | | | | | | | | | | | |
|------------------|----|----|----|----|----|---|-----|-------------------------------|---|---|---|---|---|---|---|
| 15 | 14 | 13 | 12 | 11 | 10 | 9 | 8 | 7 | 6 | 5 | 4 | 3 | 2 | 1 | 0 |
| Register Address | | | | | | | RWN | Data that is written or read. | | | | | | | |

Table 10. Register Descriptions and Addresses

| ADDRESS | NAME | FUNCTION |
|---------|--------------|---|
| H0x00 | RXCTRL1 | Receiver Control Register 1 |
| H0x01 | RXCTRL2 | Receiver Control Register 2 |
| H0x02 | RXSTAT | Receiver Status Register |
| H0x03 | SET_CML | CML Output Level Setting Register |
| H0x04 | SET_LOS | LOS Threshold Assert Level Setting Register |
| H0x0E | MODECTRL | General Control Register |
| H0x12 | SET_LOSTIMER | LOS Timer Setting Register |

3-Wire Digital Communication

General

The MAX3945 implements a proprietary 3-wire digital interface. An external controller generates the clock. The 3-wire interface consists of an SDA bidirectional data line, an SCL clock signal input, and a CSEL chip-select input (active high). The external master initiates a data transfer by asserting the CSEL pin. The master starts to generate a clock signal after the CSEL has been set to 1. All data transfers are most significant bit (MSB) first.

Protocol

Each operation consists of 16-bit transfers (15-bit address/data, 1-bit RWN). The bus master generates 16 clock cycles to SCL. All operations transfer 8 bits to the MAX3945. The RWN bit determines if the cycle is read or write. See Table 9.

Register Addresses

The MAX3945 contains seven registers available for programming. Table 10 shows the registers and addresses.

Write Mode (RWN = 0)

The master generates 16 total clock cycles at SCL. The master outputs a total of 16 bits (MSB first) to the SDA

line at falling edge of the clock. The master closes the transmission by setting CSEL to 0. Figure 5 shows the interface timing, and Table 11 defines the various timing parameters.

Read Mode (RWN = 1)

The master generates 16 total clock cycles at SCL. The master outputs a total of 8 bits (MSB first) to the SDA line at falling edge of the clock. The SDA line is released after the RWN bit has been transmitted. The slave outputs 8 bits of data (MSB first) at rising edge of the clock. The master closes the transmission by setting CSEL to 0. Figure 5 shows the interface timing.

Mode Control

Normal mode allows read-only instruction for all registers except MODECTRL. Normal mode is the default mode.

Setup mode allows the master to write unrestricted data into any register except the RXSTAT register. To enter setup mode, the MODECTRL register (address = H0x0E) must be set to H0x12. After the MODECTRL register has been set to H0x12, the next operation is unrestricted. The setup mode is automatically exited after the next operation is finished. This sequence must be repeated if further unrestricted settings are necessary.

1.0625Gbps to 11.3Gbps, SFP+ Dual-Path Limiting Amplifier

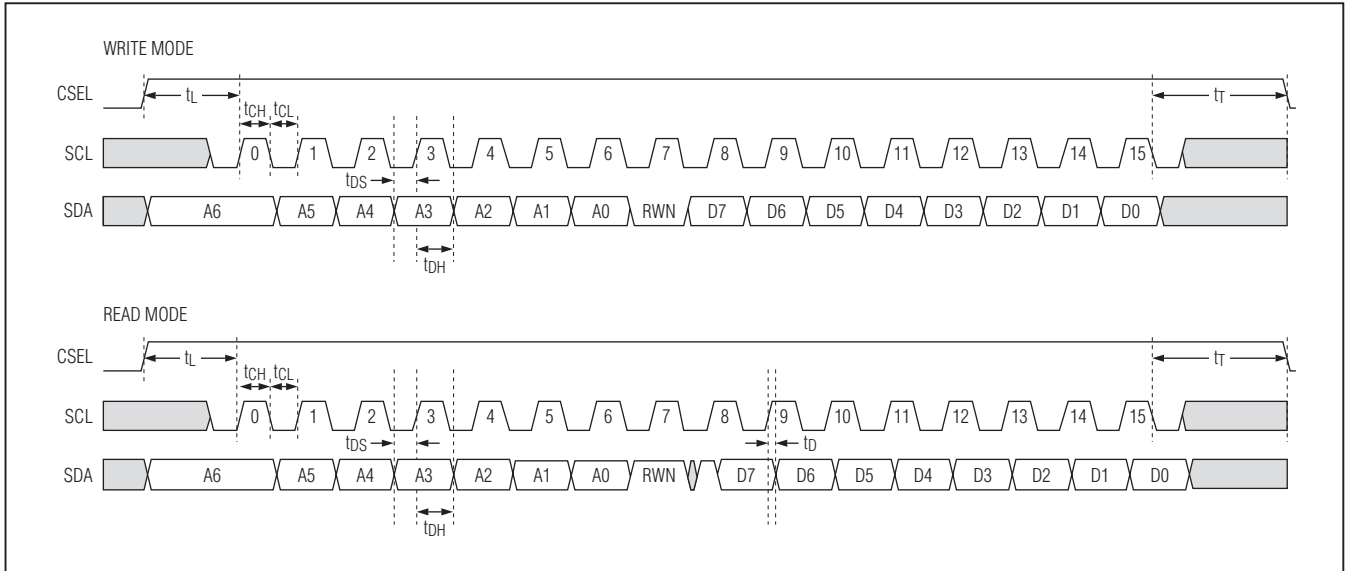

Figure 5. Timing for the 3-Wire Digital Interface

Table 11. Interface Timing Parameters

| SYMBOL | DEFINITION |
|----------|---|
| t_L | CSEL leading time before the first SCL edge |
| t_{CH} | SCL pulse-width high |
| t_{CL} | SCL pulse-width low |
| t_D | SCL rise to SDA propagation time |
| t_{DS} | SDA setup time |
| t_{DH} | SDA hold time |
| t_T | CSEL trailing time after last SCL edge |

Register Descriptions

Receiver Control Register 1 (RXCTRL1)

| Bit # | 7 | 6 | 5 | 4 | 3 | 2 | 1 | 0 | ADDRESS |
|---------------|-------|-------|----|---------|-----|-----|----------|----|---------|
| Name | RXDE1 | RXDE0 | X* | SOFTRES | BW1 | BW0 | RATE_SEL | X* | H0x00 |
| Default Value | 0 | 0 | 1 | 0 | 1 | 1 | 1 | 1 | |

*Do not change default setting.

Bits 7 and 6: RXDE[1:0]. These 2 bits are used to control deemphasis of the output waveform. See Table 5 for the bit settings and corresponding deemphasis levels.

Bit 4: SOFTRES. When this bit is set to 1 during a 3-wire interface write operation, all registers are set to the default state when CSEL goes low.

Bits 3 and 2: BW[1:0]. When RATE_SEL = 0, these 2 bits control the bandwidth of the limiting amplifier. See Table 1 for the settings and corresponding filter selection.

Bit 1: RATE_SEL. RATE_SEL selects between the low bandwidth data path (1.0625Gbps to 4.25Gbps) and the high bandwidth data path (4.25Gbps to 11.3Gbps). When RATE_SEL is set to 1, the high bandwidth path is chosen. When RATE_SEL is set to 0, the low bandwidth path is chosen.

1.0625Gbps to 11.3Gbps, SFP+ Dual-Path Limiting Amplifier

Receiver Control Register 2 (RXCTRL2)

| Bit # | 7 | 6 | 5 | 4 | 3 | 2 | 1 | 0 | ADDRESS |
|---------------|---------|---------|---------|--------|-------|-------|---------|-------|---------|
| Name | LOS2_EN | LOS1_EN | LOS_POL | RX_POL | SQ_EN | RX_EN | RXDE_EN | AZ_EN | H0x01 |
| Default Value | 0 | 1 | 1 | 1 | 0 | 1 | 0 | 1 | |

Bit 7: LOS2_EN. Enables or disables the RSSI monitor-based LOS circuitry, in combination with the LOS1_EN bit. The below table shows when the RSSI monitor-based LOS is disabled and enabled.

| LOS2_EN | LOS1_EN | RX_EN | Rx INPUT-BASED LOS | RSSI MONITOR-BASED LOS |
|---------|---------|-------|---------------------------|---------------------------|
| 0 | 0 | X | Disabled and powered down | Disabled and powered down |
| 0 | 1 | 1 | Enabled | Disabled and powered down |
| X | 1 | 0 | Disabled and powered down | Disabled and powered down |
| 1 | 1 | 1 | Enabled | Disabled and powered down |
| 1 | 0 | 0 | Disabled and powered down | Enabled |
| 1 | 0 | 1 | Disabled and powered down | Enabled |

Bit 6: LOS1_EN. Controls the Rx input-based LOS circuitry. When RX_EN is set to 0, the LOS detector is also disabled.

0 = disabled

1 = enabled

Bit 5: LOS_POL. Controls the polarity of the LOS pin.

0 = inverse

1 = normal

Bit 4: RX_POL. Controls the polarity of the CML output.

0 = inverse

1 = normal

Bit 3: SQ_EN. When SQ_EN = 1, the CML output is squelched when LOS is asserted.

0 = disabled

1 = enabled

Bit 2: RX_EN. Enables or disables the receive circuitry.

0 = disabled

1 = enabled

Bit 1: RXDE_EN. Enables or disables the deemphasis on the CML output.

0 = disabled

1 = enabled

Bit 0: AZ_EN. Enables or disables the autozero circuitry.

0 = disabled

1 = enabled

1.0625Gbps to 11.3Gbps, SFP+ Dual-Path Limiting Amplifier

MAX3945

Receiver Status Register (RXSTAT)

| Bit # | 7 | 6 | 5 | 4 | 3 | 2 | 1 (STICKY) | 0 (STICKY) | ADDRESS |
|---------------|---|---|---|---|---|---|---------------|---------------|---------|
| Name | X | X | X | X | X | X | POR_2d | LOS_2d | H0x02 |
| Default Value | X | X | X | X | X | X | X | X | |

Bit 1: POR_2d. When the VCC supply voltage is below 2.3V, the POR circuitry sets POR_2d high. When the supply voltage is above 2.75V, the POR circuitry deasserts, but the POR_2d bit remains high until it is read.

Bit 0: LOS_2d. Copy of the LOS status. This is a sticky bit, which means that it is cleared on a read. The first 0-to-1 transition is latched until the bit is read by the master or POR occurs.

CML Output Level Setting Register (SET_CML)

| Bit # | 7 | 6 | 5 | 4 | 3 | 2 | 1 | 0 | ADDRESS |
|---------------|---------------------|------------|------------|------------|------------|------------|------------|---------------------|---------|
| Name | SET_CML[7] (MSB) | SET_CML[6] | SET_CML[5] | SET_CML[4] | SET_CML[3] | SET_CML[2] | SET_CML[1] | SET_CML[0] (LSB) | H0x03 |
| Default Value | 0 | 1 | 0 | 1 | 1 | 1 | 0 | 0 | |

Bits 7 to 0: SET_CML[7:0]. The SET_CML register is an 8-bit register that can be set up to 255 for maximum CML output amplitude. See Table 13 for equations to determine CML output level vs. SET_CML.

LOS Threshold Assert Level Setting Register (SET_LOS)

| Bit # | 7 | 6 | 5 | 4 | 3 | 2 | 1 | 0 | ADDRESS |
|---------------|---|---|---------------------|------------|------------|------------|------------|---------------------|---------|
| Name | X | X | SET_LOS[5] (MSB) | SET_LOS[4] | SET_LOS[3] | SET_LOS[2] | SET_LOS[1] | SET_LOS[0] (LSB) | H0x04 |
| Default Value | X | X | 0 | 0 | 1 | 1 | 0 | 0 | |

Bits 5 to 0: SET_LOS[5:0]. The SET_LOS register is a 6-bit register used to program the LOS threshold. See the *Typical Operating Characteristics* section for a typical LOS threshold voltage vs. DAC code for both the Rx input-based LOS and the RSSI monitor-based LOS.

1.0625Gbps to 11.3Gbps, SFP+ Dual-Path Limiting Amplifier

General Control Register (MODECTRL)

| Bit # | 7 | 6 | 5 | 4 | 3 | 2 | 1 | 0 | ADDRESS |
|---------------|----------------------|-------------|-------------|-------------|-------------|-------------|-------------|----------------------|---------|
| Name | MODECTRL[7] (MSB) | MODECTRL[6] | MODECTRL[5] | MODECTRL[4] | MODECTRL[3] | MODECTRL[2] | MODECTRL[1] | MODECTRL[0] (LSB) | H0x0E |
| Default Value | 0 | 0 | 0 | 0 | 0 | 0 | 0 | 0 | |

Bits 7 to 0: MODECTRL[7:0]. The MODECTRL register enables a switch between normal and setup modes. The setup mode is achieved by setting this register to H0x12. MODECTRL must be updated before each write operation.

LOS Timer Setting Register (SET_LOSTIMER)

| Bit # | 7 | 6 | 5 | 4 | 3 | 2 | 1 | 0 | ADDRESS |
|---------------|---|------------------------------|---------------------|---------------------|---------------------|---------------------|---------------------|------------------------------|---------|
| Name | X | SET_ LOSTIMER[6] (MSB) | SET_ LOSTIMER[5] | SET_ LOSTIMER[4] | SET_ LOSTIMER[3] | SET_ LOSTIMER[2] | SET_ LOSTIMER[1] | SET_ LOSTIMER[0] (LSB) | H0x12 |
| Default Value | X | 0 | 0 | 0 | 0 | 0 | 0 | 0 | |

Bits 6 to 0: SET_LOSTIMER[6:0]. The SET_LOSTIMER register is a 7-bit register that can be set from 0 to 127. See the *Typical Operating Characteristics* section for a typical timer period vs. DAC code.

Table 12. Register Map

| REGISTER FUNCTION/ ADDRESS | REGISTER NAME | NORMAL MODE | SETUP MODE | BIT NUMBER/ TYPE | BIT NAME | DEFAULT VALUE | NOTES |
|--|---------------|-------------|------------|------------------|----------|---------------|--|
| Receiver Control Register 1 Address = H0x00 | RXCTRL1 | R | RW | 7 | RXDE1 | 0 | Rx deemphasis MSB control with RXDE_EN = 1 |
| | | R | RW | 6 | RXDE0 | 0 | Rx deemphasis LSB control with RXDE_EN = 1 |
| | | R | RW | 5 | X | 1 | Must be set to 1 |
| | | R | RW | 4 | SOFTRES | 0 | Soft reset control bit |
| | | R | RW | 3 | BW1 | 1 | Input bandwidth control with RATE_SEL = 0: 00: 1GHz 01: 2.1GHz 10: 2.5GHz 11: 3GHz |
| | | R | RW | 2 | BW0 | 1 | |
| | | R | RW | 1 | RATE_SEL | 1 | Rate-select control 0: 1G/4G mode 1: fast mode |
| | | R | RW | 0 | X | 1 | Must be set to 1 |

1.0625Gbps to 11.3Gbps, SFP+ Dual-Path Limiting Amplifier

MAX3945

Table 12. Register Map (continued)

| REGISTER FUNCTION/ ADDRESS | REGISTER NAME | NORMAL MODE | SETUP MODE | BIT NUMBER/ TYPE | BIT NAME | DEFAULT VALUE | NOTES |
|---|---------------|-------------|------------|------------------|----------|---------------|--|
| Receiver Control Register 2 Address = H0x01 | RXCTRL2 | R | RW | 7 | LOS2_EN | 0 | RSSI monitor-based LOS 0: disabled 1: enabled when LOS1_EN = 0 |
| | | R | RW | 6 | LOS1_EN | 1 | Rx input-based LOS 0: disabled 1: enabled |
| | | R | RW | 5 | LOS_POL | 1 | LOS polarity 0: inverse 1: normal |
| | | R | RW | 4 | RX_POL | 1 | Rx polarity 0: inverse 1: normal |
| | | R | RW | 3 | SQ_EN | 0 | Squelch 0: disabled 1: enabled |
| | | R | RW | 2 | RX_EN | 1 | Rx control 0: disabled 1: enabled |
| | | R | RW | 1 | RXDE_EN | 0 | Rx deemphasis 0: disabled 1: enabled |
| | | R | RW | 0 | AZ_EN | 1 | Rx autozero control 0: disabled 1: enabled |
| Receiver Status Register Address = H0x02 | RXSTAT | R | R | 1 (sticky) | POR_2d | X | POR -> Vcc low limit violation |
| | | R | R | 0 (sticky) | LOS_2d | X | Copy of LOS status |

1.0625Gbps to 11.3Gbps, SFP+ Dual-Path Limiting Amplifier

Table 12. Register Map (continued)

| REGISTER FUNCTION/ ADDRESS | REGISTER NAME | NORMAL MODE | SETUP MODE | BIT NUMBER/ TYPE | BIT NAME | DEFAULT VALUE | NOTES |
|---|---------------|-------------|------------|------------------|-----------------|---------------|-----------------------|
| CML Output Level Setting Register Address = H0x03 | SET_CML | R | RW | 7 | SET_CML[7] | 0 | MSB output level DAC |
| | | R | RW | 6 | SET_CML[6] | 1 | |
| | | R | RW | 5 | SET_CML[5] | 0 | |
| | | R | RW | 4 | SET_CML[4] | 1 | |
| | | R | RW | 3 | SET_CML[3] | 1 | |
| | | R | RW | 2 | SET_CML[2] | 1 | |
| | | R | RW | 1 | SET_CML[1] | 0 | |
| LOS Threshold Assert Level Setting Register Address = H0x04 | SET_LOS | R | RW | 5 | SET_LOS[5] | 0 | MSB LOS threshold DAC |
| | | R | RW | 4 | SET_LOS[4] | 0 | |
| | | R | RW | 3 | SET_LOS[3] | 1 | |
| | | R | RW | 2 | SET_LOS[2] | 1 | |
| | | R | RW | 1 | SET_LOS[1] | 0 | |
| | | R | RW | 0 | SET_LOS[0] | 0 | LSB LOS threshold DAC |
| General Control Register Address = H0x0E | MODECTRL | RW | RW | 7 | MODECTRL[7] | 0 | MSB mode control |
| | | RW | RW | 6 | MODECTRL[6] | 0 | |
| | | RW | RW | 5 | MODECTRL[5] | 0 | |
| | | RW | RW | 4 | MODECTRL[4] | 0 | |
| | | RW | RW | 3 | MODECTRL[3] | 0 | |
| | | RW | RW | 2 | MODECTRL[2] | 0 | |
| | | RW | RW | 1 | MODECTRL[1] | 0 | |
| LOS Timer Setting Register Address = H0x12 | SET_LOSTIMER | R | RW | 6 | SET_LOSTIMER[6] | 0 | MSB LOS timer |
| | | R | RW | 5 | SET_LOSTIMER[5] | 0 | |
| | | R | RW | 4 | SET_LOSTIMER[4] | 0 | |
| | | R | RW | 3 | SET_LOSTIMER[3] | 0 | |
| | | R | RW | 2 | SET_LOSTIMER[2] | 0 | |
| | | R | RW | 1 | SET_LOSTIMER[1] | 0 | |
| | | R | RW | 0 | SET_LOSTIMER[0] | 0 | LSB LOS timer |

1.0625Gbps to 11.3Gbps, SFP+ Dual-Path Limiting Amplifier

Design Procedure

Programming CML Output Levels

See Tables 13 and 14. For each value of the bits RXDE1 and RXDE0 in Table 13, the value of deemphasis does vary with the SET_CML[7:0] setting. In Table 13, the values of deemphasis are given for the setting SET_CML[7:0] = 120d. The variation of deemphasis for other values of SET_CML[7:0] is shown in the *Typical Operating Characteristics* (see the Deemphasis Value vs. SET_CML DAC Setting (RATE_SEL = 1) graph). Note that even though RXDE_EN = 0, there is still some deemphasis for RATE_SEL = 1 for values of amplitude control below SET_CML[7:0] = 170d.

Select the Coupling Capacitor

For AC-coupling, the coupling capacitors C_{IN} and C_{OUT} should be selected to minimize the receiver's deterministic jitter. Jitter is decreased as the input low frequency cutoff (f_{IN}) is decreased: $f_{IN} = 1/[2\pi(50)(C_{IN})]$. The recommended value of C_{IN} and C_{OUT} is 0.1μF for the MAX3945.

Select the Offset-Correction Capacitor

The capacitor between CAZ and ground determines the time constant of the signal path DC-offset cancellation loop. A 0.1μF capacitor between CAZ and ground is recommended for the MAX3945.

Applications Information

Layout Considerations

Use good, high-frequency layout techniques and multiple-layer boards with uninterrupted ground planes to minimize EMI and crosstalk.

Exposed-Pad Package

The exposed pad on the 16-pin TQFN provides a very low-thermal resistance path for heat removal from the IC. The pad is also electrical ground on the MAX3945 and must be soldered to the circuit board ground for proper thermal and electrical performance. Refer to Application Note 862: *HFAN-08.1: Thermal Considerations of QFN and Other Exposed-Paddle Packages* for additional information.

Table 13. CML Output Amplitude Equations (Typical)

| RXCTRL1[1] | RXCTRL2[1] | RXCTRL1[7:6] | | DEEMPHASIS (dB) (SET_CML[7:0] = 120d) | EQUATION FOR (V _{ROUT+} - V _{ROUT-}) |
|------------|------------|--------------|-------|--|---|
| RATE_SEL | RXDE_EN | RXDE1 | RXDE0 | | |
| 0 | X | X | X | 0 | 45mV _{P-P} + 4.5mV _{P-P} x SET_CML |
| 1 | 0 | X | X | 0.72 | 4.5mV _{P-P} x SET_CML |
| 1 | 1 | 0 | 0 | 1.17 | -4mV _{P-P} + 4.1mV _{P-P} x SET_CML |
| 1 | 1 | 0 | 1 | 1.89 | -7mV _{P-P} + 3.9mV _{P-P} x SET_CML |
| 1 | 1 | 1 | 0 | 2.48 | -10mV _{P-P} + 3.6mV _{P-P} x SET_CML |
| 1 | 1 | 1 | 1 | 3.86 | -13mV _{P-P} + 3.3mV _{P-P} x SET_CML |

Table 14. SET_CML DAC Codes for 400mV_{P-P} and 800mV_{P-P} Output Levels

| RXCTRL1[1] | RXCTRL2[1] | RXCTRL1[7:6] | | SET_CML DAC CODE | |
|------------|------------|--------------|-------|----------------------|----------------------|
| | | RXDE1 | RXDE0 | 400mV _{P-P} | 800mV _{P-P} |
| 0 | X | X | X | 80 | 169 |
| 1 | 0 | X | X | 91 | 181 |
| 1 | 1 | 0 | 0 | 98 | 194 |
| 1 | 1 | 0 | 1 | 106 | 208 |
| 1 | 1 | 1 | 0 | 115 | 225 |
| 1 | 1 | 1 | 1 | 126 | 245 |