

Click [here](#) to ask an associate for production status of specific part numbers.

Dual-Channel, 0V to 76V Current-Sense Amplifier

MAX40201

General Description

The MAX40201 dual-channel, high-side, current-sense amplifier has V_{OS} of less than $12\mu\text{V}$ (max) and gain error of less than 0.1% (max). The outputs of the MAX40201 are voltage outputs capable of swinging to a few tens of millivolts of the V_{DD} rail and ground.

The MAX40201 features an input common-mode voltage range from 0V to 76V with 80kHz of small-signal bandwidth, which makes it ideal for interfacing with a SAR ADC for multichannel multiplexed data acquisition systems.

The MAX40201 operates over the -40°C to $+125^{\circ}\text{C}$ temperature range. The MAX40201 is offered in 8-bump wafer-level package (WLP) and 8-pin $\mu\text{MAX}^{\text{®}}$ package.

Applications

- Base Stations and Communication Equipment
- Power Management Systems
- Server Backplanes
- Industrial Control and Automation

Benefits and Features

- 0V to 76V Input Common Mode
- Low $12\mu\text{V}$ (max) Input Offset Voltage
- Low 0.1% (max) Gain Error
- Gain Options
 - $G = 25\text{V/V}$ (MAX40201T)
 - $G = 50\text{V/V}$ (MAX40201F)
 - $G = 100\text{V/V}$ (MAX40201H)
 - $G = 200\text{V/V}$ (MAX40201W)
- 1.3mm x 2mm 8-Bump WLP and 8-Pin μMAX Packages

[Ordering Information](#) appears at end of data sheet.

μMAX is a registered trademark of Maxim Integrated Products, Inc.

Typical Operating Circuit

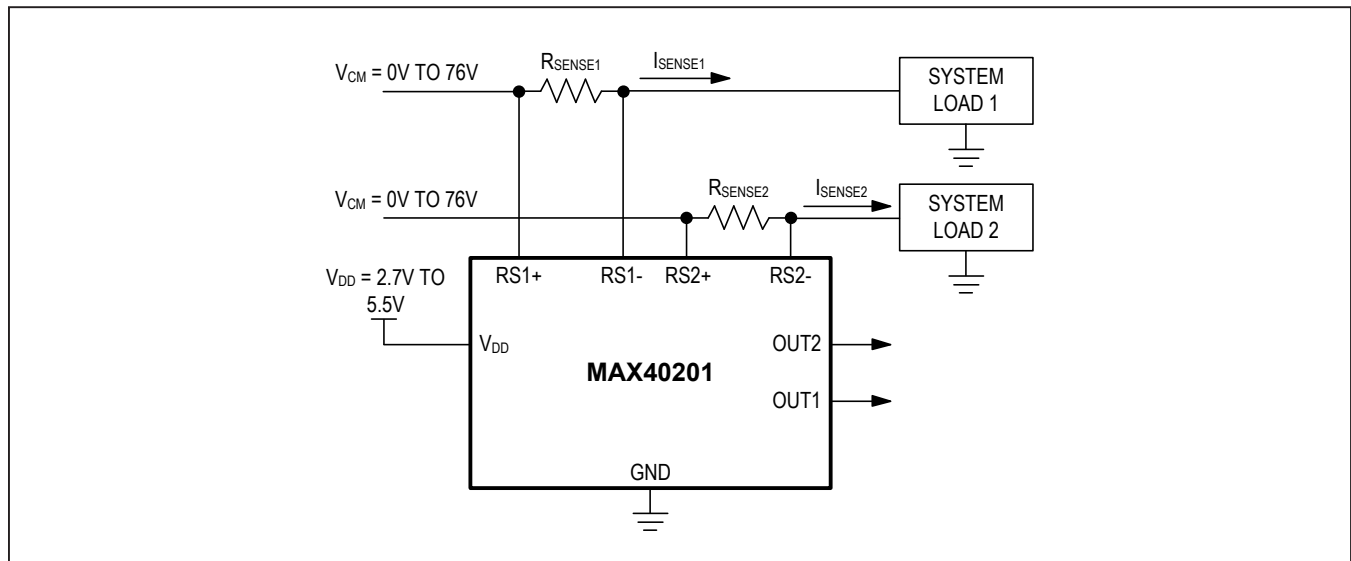

19-100028; Rev 5; 10/20

Absolute Maximum Ratings

V _{DD} to GND	-0.3V to +6.0V	Operating Temperature Range.....	-40°C to +125°C
RS+, RS- to GND	-0.3V to +80V	Junction Temperature.....	+150°C
RS+ to RS-	±30V	Storage Temperature Range.....	-65°C to +150°C
Continuous Input Current (Any Pin).....	±20mA	Lead Temperature (soldering, 10s)(μMAX only)	+300°C
Continuous Power Dissipation (T _A = +70°C)		Soldering Temperature (reflow).....	+260°C
WLP (derate 13.4mW/°C above +70°C).....	1072mW		
μMAX (derate 4.8mW/°C above +70°C).....	387.8mW		

Stresses beyond those listed under "Absolute Maximum Ratings" may cause permanent damage to the device. These are stress ratings only, and functional operation of the device at these or any other conditions beyond those indicated in the operational sections of the specifications is not implied. Exposure to absolute maximum rating conditions for extended periods may affect device reliability.

Package Thermal Characteristics (Note 1)

WLP	Junction-to-Ambient Thermal Resistance (θ _{JA})	74.7°C/W	μMAX	Junction-to-Ambient Thermal Resistance (θ _{JA})	206.3°C/W
				Junction-to-Case Thermal Resistance (θ _{JC}).....	42°C/W

Note 1: Package thermal resistances were obtained using the method described in JEDEC specification JESD51-7, using a four-layer board. For detailed information on package thermal considerations, refer to www.maximintegrated.com/thermal-tutorial.

Electrical Characteristics

(V_{RS+} = V_{RS-} = +50V, V_{DD} = +3.3V, V_{SENSE} = V_{RS+} - V_{RS-} = 1mV, T_A = -40°C to +125°C, unless otherwise noted. Typical values are at T_A = +25°C.) (Note 2)

PARAMETER	SYMBOL	CONDITIONS	MIN	TYP	MAX	UNITS
DC CHARACTERISTICS						
Supply Voltage	V _{DD}	Guaranteed by PSRR	2.7		5.5	V
Supply Current (Both Channels)	I _{DD}	No loads		1.3	2.1	mA
Power-Supply Rejection Ratio	PSRR	2.7V ≤ V _{DD} ≤ 5.5V	110			dB
Input Common-Mode Voltage Range	V _{CM}	Guaranteed by CMRR	0		76	V
Input Bias Current at V _{RS+} and V _{RS-}	I _{RS+} , I _{RS-}				0.2	μA
Input Offset Current	I _{RS+} - I _{RS-}				0.2	μA
Input Leakage Current	I _{RS+} , I _{RS-}	V _{DD} = 0V, V _{RS+} = 76V			0.2	μA
Common-Mode Rejection Ratio	CMRR	0V < V _{RS+} < 76V	130			dB
Input Offset Voltage	V _{OS}	μMAX	T _A = +25°C, 0 < V _{CM} < 76V		0.5	±12
			-40°C ≤ T _A ≤ +125°C, 0 < V _{CM} < 76V			±25
		WLP	T _A = +25°C, 0 < V _{CM} < 76V			±20
			-40°C ≤ T _A ≤ +125°C, 0 < V _{CM} < 76V			±33
Input Offset Voltage Drift	TCV _{OS}				130	nV/°C

Electrical Characteristics (continued)

($V_{RS+} = V_{RS-} = +50V$, $V_{DD} = +3.3V$, $V_{SENSE} = V_{RS+} - V_{RS-} = 1mV$, $T_A = -40^{\circ}C$ to $+125^{\circ}C$, unless otherwise noted. Typical values are at $T_A = +25^{\circ}C$.) (Note 2)

PARAMETER	SYMBOL	CONDITIONS	MIN	TYP	MAX	UNITS
Input Sense Voltage	V_{SENSE}	MAX40201T (G = 25V/V)		100		mV
		MAX40201F (G = 50V/V)		50		
		MAX402015H (G = 100V/V)		25		
		MAX40201W (G = 200V/V)		12.5		
Gain (Note 3)	G	Full-scale $V_{SENSE} = 100mV$		25		V/V
		Full-scale $V_{SENSE} = 50mV$		50		
		Full-scale $V_{SENSE} = 25mV$		100		
		Full-scale $V_{SENSE} = 12.5mV$		200		
Gain Error	GE	μ MAX	$T_A = +25^{\circ}C$		0.1	%
			$-40^{\circ}C \leq T_A \leq +125^{\circ}C$		0.25	
		WLP	$T_A = +25^{\circ}C$		0.15	
			$-40^{\circ}C \leq T_A \leq +125^{\circ}C$		0.3	
Output Resistance	R_{OUT}	$V_{OUT} = V_{DD} / 2$, $I_{OUT} = \pm 500\mu A$		0.1		Ω
Output Low Voltage	V_{OL}	Sink $500\mu A$			15	mV
		No load			4	
Output High Voltage	V_{OH}	Source $500\mu A$		$V_{DD} - 0.015$		V
AC CHARACTERISTICS						
Signal Bandwidth	BW -3dB	All gain configurations $V_{SENSE} > 5mV$		80		kHz
AC Power-Supply Rejection Ratio	AC PSRR	f = 200kHz		40		dB
AC CMRR	AC CMRR	f = 200kHz, 100mV sine wave		47		dB
Capacitive Load Stability	C_{LOAD}	With 250Ω isolation resistor		20		nF
		Without any isolation resistor		200		pF
Input Voltage-Noise Density	e_n	f = 1kHz		95		nV/ \sqrt{Hz}
Power-Up Time (Note 4)				500		μs
Settling Time (Settling to 0.1%)		V_{SENSE} steps from 20% FS to 80% FS ($t_R = t_F = 5\mu s$), $V_{CM} = 24V$, $C_L = 20pF$		20		μs

Note 2: All devices are 100% production tested at $T_A = +25^{\circ}C$. All temperature limits are guaranteed by design.

Note 3: Gain and offset voltage are calculated based on two point measurements: V_{SENSE1} and V_{SENSE2} .
 $V_{SENSE1} = 20\% \times \text{Full Scale } V_{SENSE}$. $V_{SENSE2} = 80\% \times \text{Full Scale } V_{SENSE}$.

Note 4: Output is high-Z during power-up.

Typical Operating Characteristics

($V_{DD} = 3.3V$, $V_{RS+} = V_{RS-} = 50V$, $V_{SENSE-} = V_{RS+} - V_{RS-} = 1mV$, $T_A = +25^{\circ}C$, unless otherwise noted.)

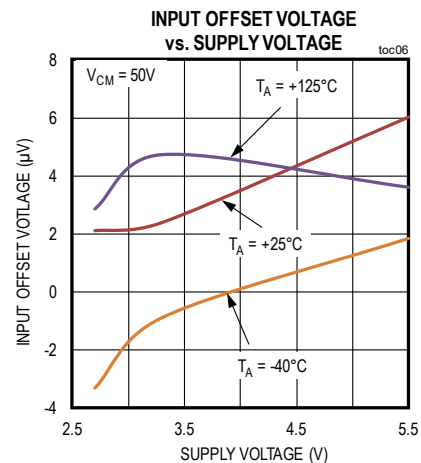
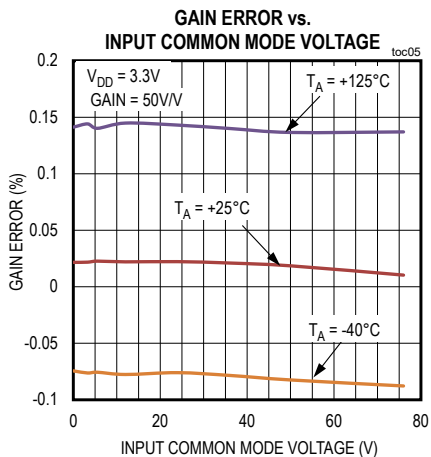
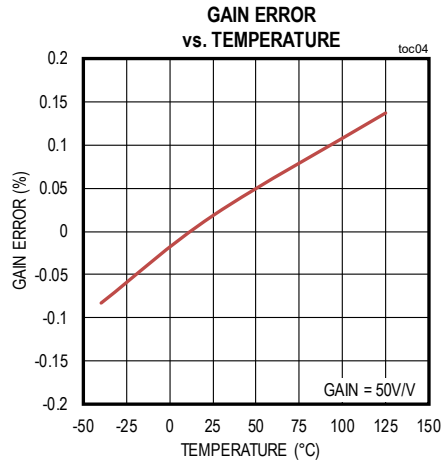
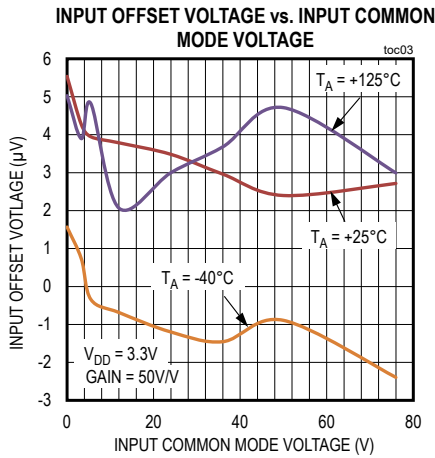
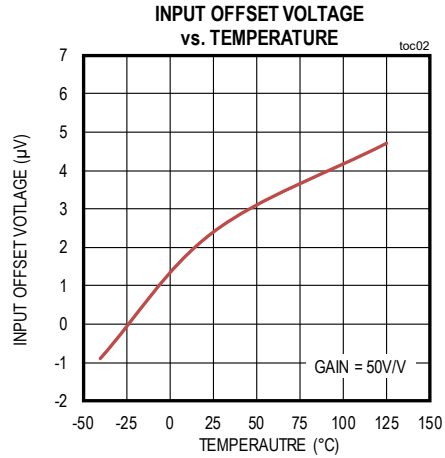
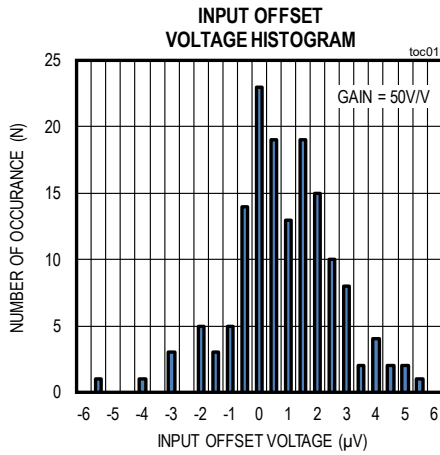

Typical Operating Characteristics (continued)

($V_{DD} = 3.3V$, $V_{RS_+} = V_{RS_} = 50V$, $V_{SENSE_} = V_{RS_+} - V_{RS_} = 1mV$, $T_A = +25^\circ C$, unless otherwise noted.)

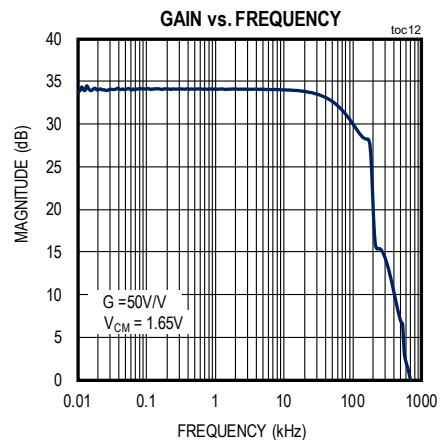
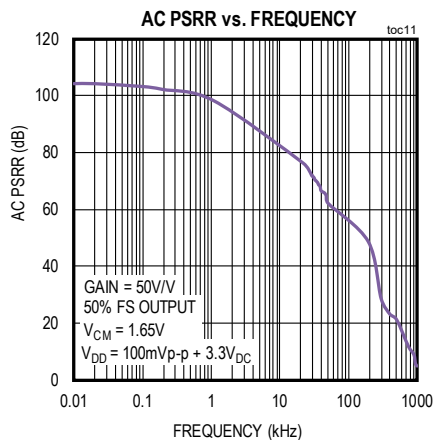
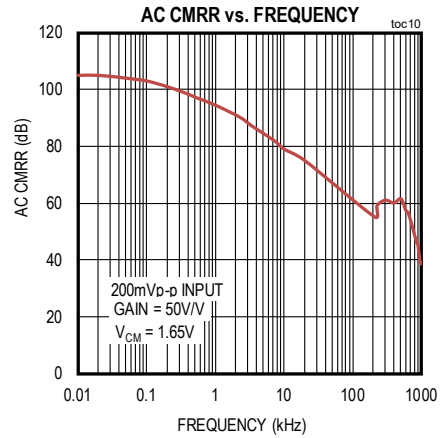
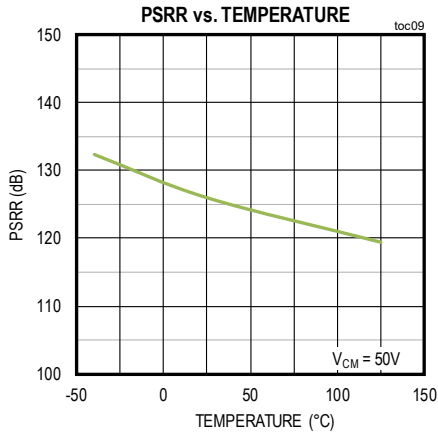
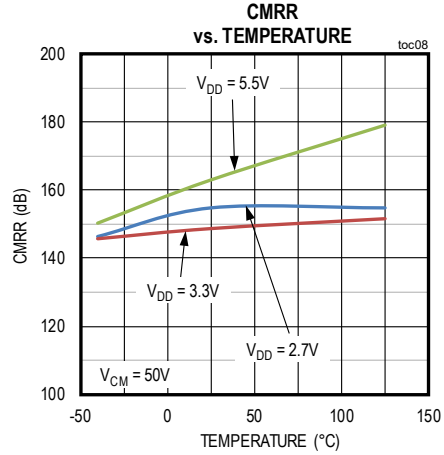
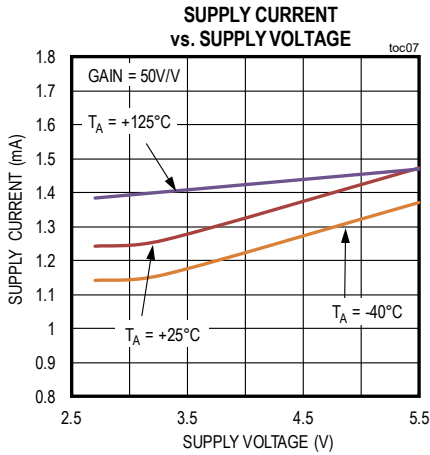

Typical Operating Characteristics (continued)

($V_{DD} = 3.3V$, $V_{RS+} = V_{RS-} = 50V$, $V_{SENSE-} = V_{RS+} - V_{RS-} = 1mV$, $T_A = +25^{\circ}C$, unless otherwise noted.)

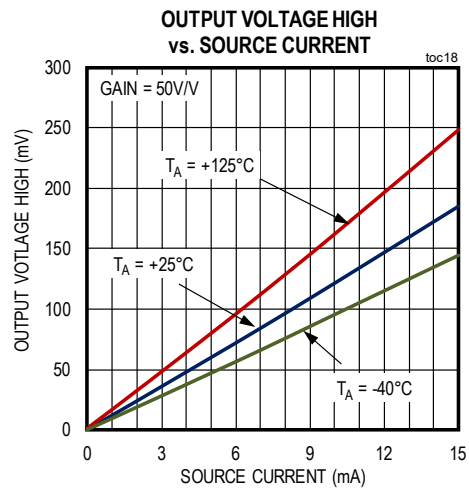
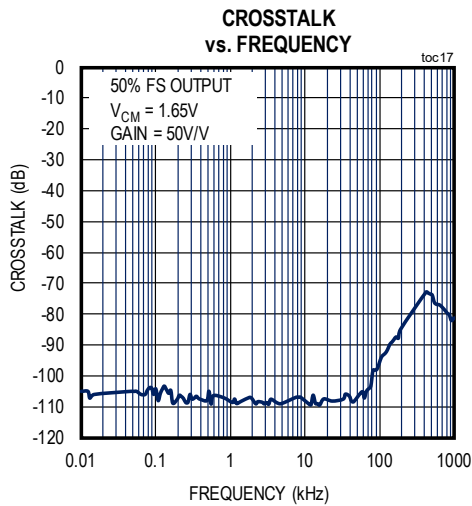
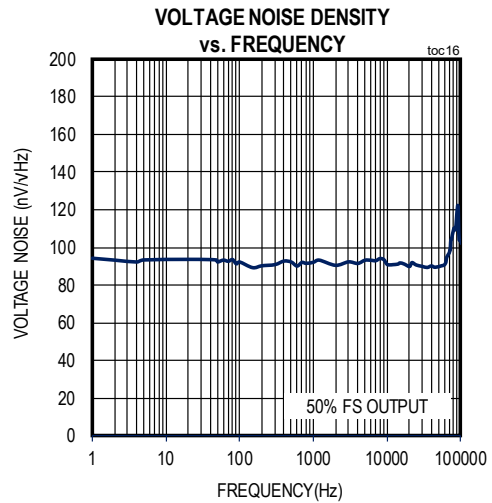
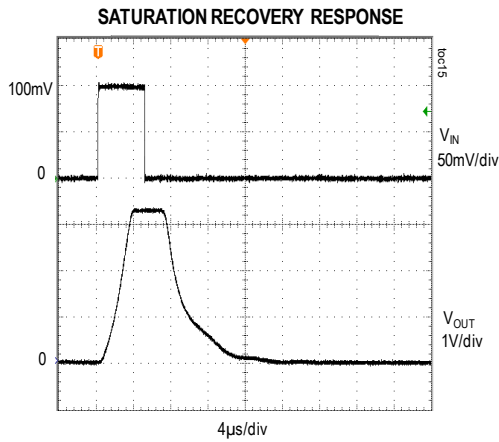
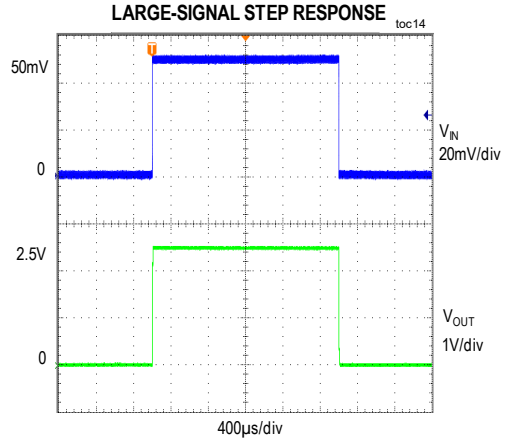
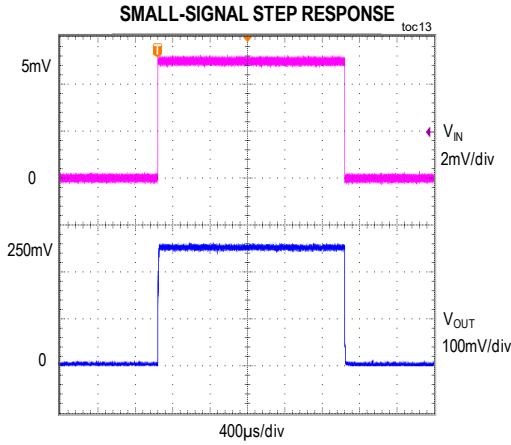

Typical Operating Characteristics (continued)

($V_{DD} = 3.3V$, $V_{RS+} = V_{RS-} = 50V$, $V_{SENSE-} = V_{RS+} - V_{RS-} = 1mV$, $T_A = +25^{\circ}C$, unless otherwise noted.)

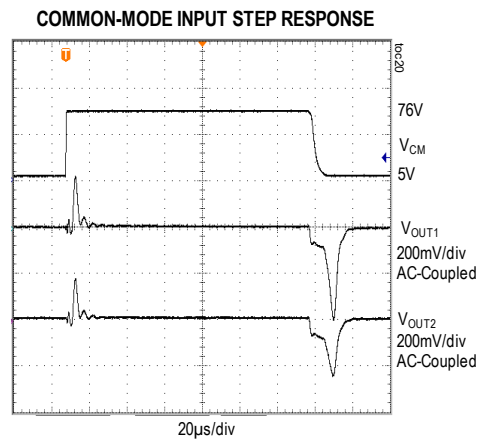
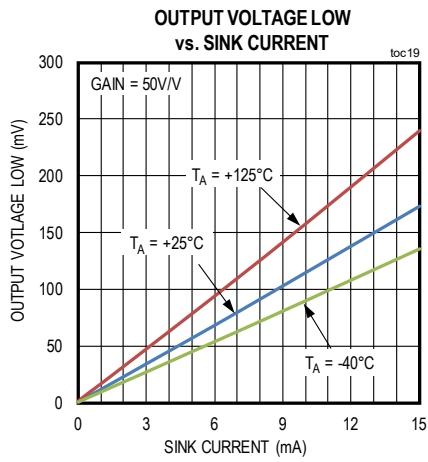

Pin Configuration

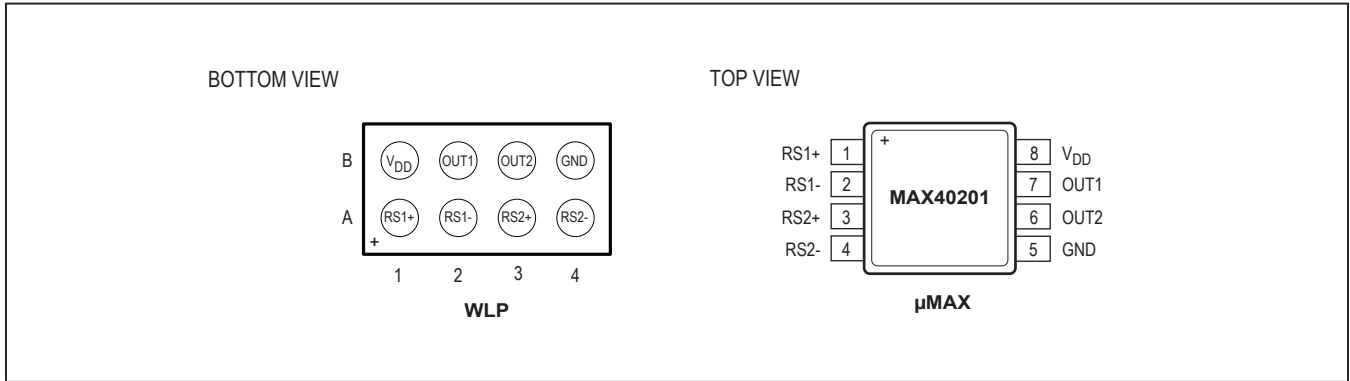

Pin Description

PIN		NAME	FUNCTION
WLP	µMAX		
A1	1	RS1+	Channel 1 External Resistor Power-Side Connection
A2	2	RS1-	Channel 1 External Resistor Load-Side Connection
A3	3	RS2+	Channel 2 External Resistor Power-Side Connection
A4	4	RS2-	Channel 2 External Resistor Load-Side Connection
B1	8	V _{DD}	Supply Voltage
B2	7	OUT1	Output Channel 1
B3	6	OUT2	Output Channel 2
B4	5	GND	Ground

Simplified Functional Diagram

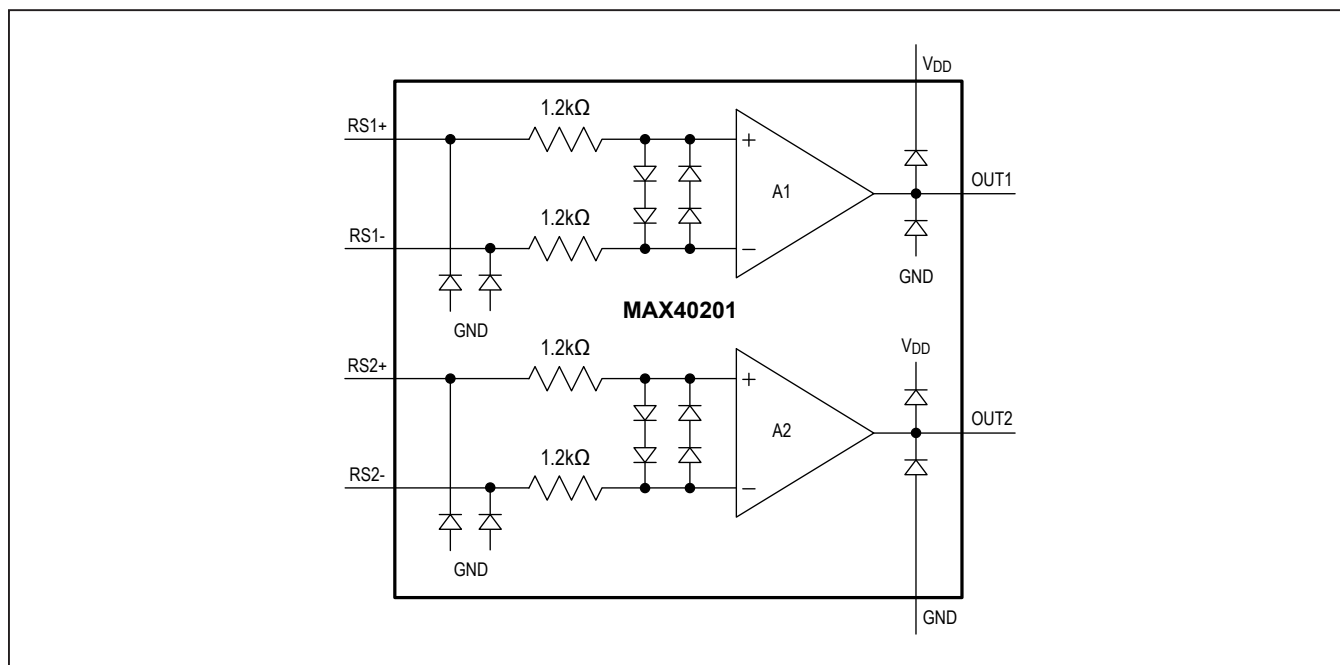

Detailed Description

The MAX40201 high-side, current-sense amplifier features a 0V to 76V input common-mode range that is independent of supply voltage. This feature allows the monitoring of current out of a battery as low as 2.7V and enables high-side current sensing at voltages greater than the supply voltage (V_{DD}). The MAX40201 monitors current through a current-sense resistor and amplifies the voltage across the resistor.

High-side current monitoring does not interfere with the ground path of the load being measured, making the MAX40201 particularly useful in a wide range of high-voltage systems.

Applications Information

Recommended Component Values

Ideally, the maximum load current develops the full-scale sense voltage across the current-sense resistor. Choose the gain needed to yield the maximum output voltage required for the application:

$$V_{OUT} = V_{SENSE} \times A_V$$

where V_{SENSE} is the full-scale sense voltage, 100mV for gain of 25V/V, 50mV for gain of 50V/V, 25mV for gain of 100V/V, 12.5mV for gain of 200V/V, and A_V is the gain of the device.

In applications monitoring a high current, ensure that R_{SENSE} is able to dissipate its own I^2R loss. If the resistor's power dissipation exceeds the nominal value, its value may drift or it may fail altogether. The MAX40201 senses a wide variety of currents with different sense-resistor values.

Choosing the Sense Resistor

Choose R_{SENSE} based on the following criteria:

Voltage Loss: A high R_{SENSE} value causes the power-source voltage to degrade through IR loss. For minimal voltage loss, use the lowest R_{SENSE} value.

Accuracy: A high R_{SENSE} value allows lower currents measured more accurately. This is due to offsets becoming less significant when the sense voltage is larger. For best performance, select R_{SENSE} to provide approximately 100mV (gain of 25V/V), 50mV (gain of 50V/V), or 25mV (gain of 100V/V), 12.5mV (gain of 200V/V) of sense voltage for the full-scale current in each application.

Efficiency and Power Dissipation: At high current levels, the I^2R losses in R_{SENSE} can be significant. Consider this when choosing the resistor value and its power dissipation (wattage) rating. In addition, the sense resistor's value might drift if it heats up excessively.

Inductance: Keep inductance low if I_{SENSE} has a large high-frequency component. Wire-wound resistors have the highest inductance, while metal film is somewhat better. Low-inductance, metal-film resistors are also available. Instead of being spiral wrapped around a core, as in metal-film or wire wound resistors, they are a straight band of metal and are available in values under 1Ω .

Take care to eliminate parasitic trace resistance from causing errors in the sense voltage because of the high currents that flow through R_{SENSE} . Either use a four terminal current-sense resistor or use Kelvin (force and sense) PCB layout techniques.

Power-Supply Bypassing

Power-supply bypass capacitors are recommended for best performance and should be placed as close as possible to the supply and ground terminals of the device. A typical value for this supply bypass capacitor is $0.1\mu F$

(NP0/C0G type) close to the V_{DD}/GND bumps. The capacitors should be rated for at least twice the maximum expected applied voltage. Applications with noisy or high-impedance power supplies may require additional decoupling capacitors to reject power-supply noise.

Base Station Application Circuit

An example of a typical application (Figure 1) of this high-voltage, high-precision current-sense amplifier is in base-station systems where there is a need to monitor the current flowing in the power amplifier. Such amplifiers, depending on the technology, can be biased up to 50V or 60V thus requiring a current-sense amplifier like the MAX40201 with high-voltage common mode. The very low input offset voltage of the MAX40201 minimizes the value of the external sense resistor thus resulting in system power-saving.

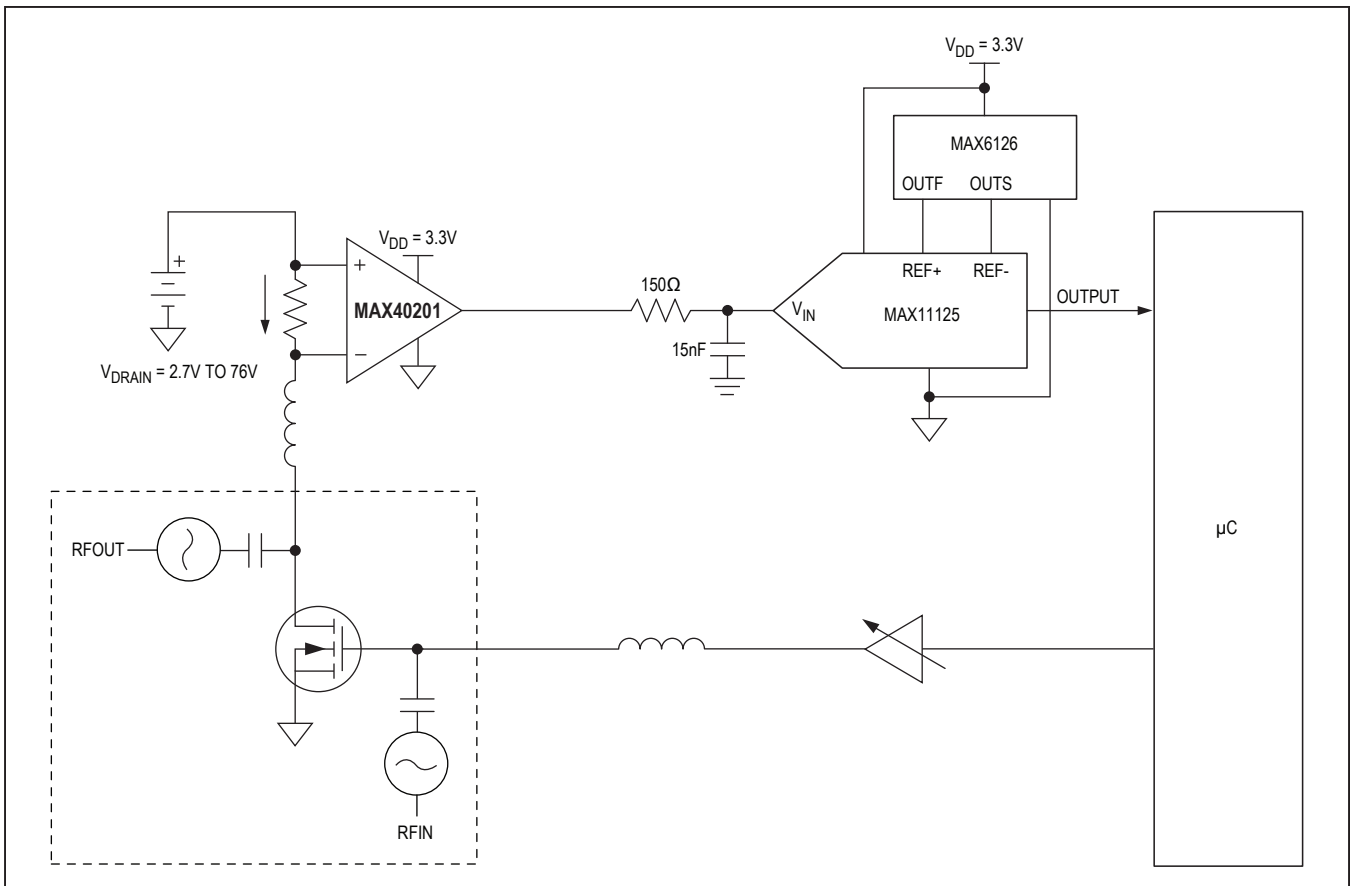

Figure 1. MAX40201 Used in Base-Station Application

Ordering Information

PART	GAIN (V/V)	TEMP RANGE	PIN-PACKAGE	TOP MARK
MAX40201TAWA+*	25	-40°C to +125°C	8 WLP	+AAK
MAX40201TAUA+*	25	-40°C to +125°C	8 μ MAX	—
MAX40201FAWA+*	50	-40°C to +125°C	8 WLP	+AAL
MAX40201FAUA+	50	-40°C to +125°C	8 μ MAX	—
MAX40201HAWA+*	100	-40°C to +125°C	8 WLP	+AAM
MAX40201HAUA+*	100	-40°C to +125°C	8 μ MAX	—
MAX40201WAWA+	200	-40°C to +125°C	8 WLP	+AAN
MAX40201WAUA+*	200	-40°C to +125°C	8 μ MAX	—

+Denotes a lead(Pb)-free/RoHS-compliant package.

*Future Product—Contact factory for availability.

Chip Information

PROCESS: BiCMOS

Package Information

For the latest package outline information and land patterns (footprints), go to www.maximintegrated.com/packages. Note that a "+", "#", or "-" in the package code indicates RoHS status only. Package drawings may show a different suffix character, but the drawing pertains to the package regardless of RoHS status.

PACKAGE TYPE	PACKAGE CODE	OUTLINE NO.	LAND PATTERN NO.
8 WLP	W81A1+1	21-100147	Refer to Application Note 1891
8 μ MAX	U8+1	21-0036	90-0092