

# MAX4060/MAX4061/ MAX4062

# Differential Microphone Preamplifiers with Internal Bias and Complete Shutdown

## General Description

The MAX4060/MAX4061/MAX4062 are differential-input microphone preamplifiers optimized for notebook and PDA audio systems. These devices feature adjustable gain with excellent power-supply rejection and common-mode rejection ratios, making them ideal for lownoise applications in portable audio systems.

The MAX4060/MAX4062 are capable of switching their output between the differential input and a single-ended auxiliary microphone amplifier input. In addition, the MAX4060/MAX4062 have a low-noise microphone bias generator. The differential gain of the MAX4061/MAX4062 is set with a single resistor. The MAX4060 has a fixed gain of 10V/V and is PC99/2001 compliant. The MAX4061 includes a complete shutdown mode. In shutdown, the supply current is reduced to 0.3µA and the current to the microphone bias is cut off for ultimate power savings.

The MAX4060 operates from a 4.5V to 5.5V single supply and the MAX4061/MAX4062 operate from 2.4V to 5.5V. All devices are specified over the extended operating temperature range, -40°C to +85°C. The MAX4060/MAX4061 are available in tiny 8-pin TDFN (3mm x 3mm x 0.8mm) and 8-pin µMAX® packages. The MAX4062 is available in a 10-pin µMAX package.

## Applications

- Notebook Audio Systems
- Tablet PCs
- PDA Audio Systems
- USB Audio Peripherals
- AES-42-Compliant Microphones
- Signal Conditioning

## Ordering Information

PART	TEMP RANGE	PIN-PACKAGE	TOP MARK
MAX4060ETA+	-40°C to +85°C	8 TDFN-EP*	ABY
MAX4060EUA+	-40°C to +85°C	8 µMAX	—
MAX4061ETA+	-40°C to +85°C	8 TDFN-EP*	ABZ
MAX4061EUA+	-40°C to +85°C	8 µMAX	—
MAX4062EUB+	-40°C to +85°C	10 µMAX	—

\*EP = Exposed pad.

+Denotes a lead(Pb)-free/RoHS-compliant package.

**Pin Configurations and Selector Guide appear at end of data sheet.**

µMAX is a registered trademark of Maxim Integrated Products, Inc.

## Features

- 2.4V to 5.5V Single-Supply Operation
- Adjustable Gain or Fixed-Gain Options
- High PSRR (86dB at 1kHz)
- High CMRR (70dB at 1kHz)
- Low Input-Referred Noise
- Integrated Microphone Bias
- 750µA Supply Current
- 0.3µA Shutdown Current
- ±4kV ESD Protection (AUX\_IN)
- Rail-to-Rail Outputs
- THD+N: 0.04% at 1kHz
- Available in Space-Saving Packages
  - 8-Pin TDFN (MAX4060/MAX4061)
  - 8-Pin µMAX (MAX4060/MAX4061)
  - 10-Pin µMAX (MAX4062)

## Typical Operating Circuit

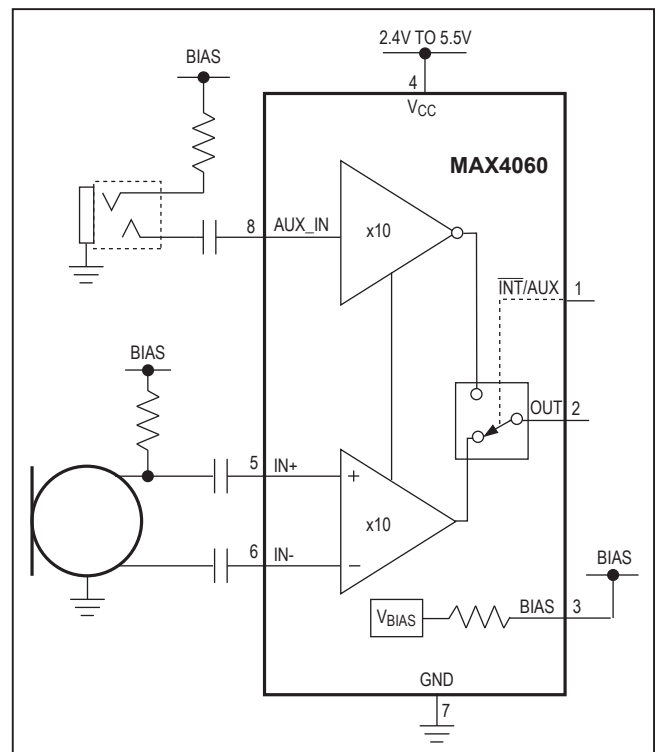

### Absolute Maximum Ratings

Supply Voltage ( $V_{CC}$  to GND) .....-0.3V to +6V  
 Any Other Pin to GND .....-0.3V to ( $V_{CC} + 0.3V$ )  
 Duration of Short Circuit to GND or  $V_{CC}$  ..... Continuous  
 Continuous Input Current (any pin) .....  $\pm 10mA$   
 Continuous Power Dissipation ( $T_A = +70^\circ C$ )  
     8-Pin TDFN (derate 24.4mW/ $^\circ C$  above  $+70^\circ C$ ) ..... 1951.2mW  
     8-Bump  $\mu$ MAX (derate 4.8mW/ $^\circ C$  above  $+70^\circ C$ ) ..... 387.8mW  
     10-Bump  $\mu$ MAX (derate 8.8mW/ $^\circ C$  above  $+70^\circ C$ ) ... 707.3mW

Operating Temperature Range .....  $-40^\circ C$  to  $+85^\circ C$   
 Junction Temperature .....  $+150^\circ C$   
 Storage Temperature Range .....  $-65^\circ C$  to  $+150^\circ C$   
 Lead Temperature (soldering, 10s) .....  $+300^\circ C$   
 Soldering Temperature (reflow) .....  $+260^\circ C$

*Stresses beyond those listed under "Absolute Maximum Ratings" may cause permanent damage to the device. These are stress ratings only, and functional operation of the device at these or any other conditions beyond those indicated in the operational sections of the specifications is not implied. Exposure to absolute maximum rating conditions for extended periods may affect device reliability.*

### Electrical Characteristics

( $V_{CC} = 3V$  for MAX4061/MAX4062,  $V_{CC} = 5V$  for MAX4060,  $V_{GND} = 0V$ ,  $V_{SHDN} = V_{CC}$ ,  $V_{INT/AUX} = 0V$ ,  $R_G = 11.11k\Omega$ ,  $R_L = 100k\Omega$  to 1.5V,  $R_{BIAS} = \infty$ ,  $T_A = T_{MIN}$  to  $T_{MAX}$ , unless otherwise noted. Typical values are at  $T_A = +25^\circ C$ .) (Notes 1, 2)

PARAMETER	SYMBOL	CONDITIONS	MIN	TYP	MAX	UNITS
Supply Voltage Range	$V_{CC}$	Inferred from PSRR test	MAX4061/MAX4062	2.4	5.5	V
			MAX4060	4.5	5.5	
Supply Current	$I_{CC}$			0.75	1.2	mA
Output Common-Mode Voltage	$V_{OCM}$		1.25	1.5	1.75	V
Slew Rate	SR	$A_V = 10V/V$		$\pm 1$		V/ $\mu s$
Supply Current in Shutdown	$I_{SHDN}$	$V_{SHDN} = 0V$ , MAX4061		0.001	1	$\mu A$
Output Short-Circuit Current	$I_{SC}$	To GND		30		mA
		To $V_{CC}$		30		
<b>DIFFERENTIAL INPUT</b> ( $V_{INT/AUX} = 0V$ for MAX4060/MAX4062, default for MAX4061)						
Input Offset Voltage	$V_{OS}$			$\pm 0.1$	$\pm 5$	mV
Common-Mode Input Voltage Range	$V_{CM}$		1		2	V
Maximum Differential Input Voltage	$V_{DIFFMAX}$	$A_V = 1V/V$ , MAX4061/MAX4062		1		V
Small-Signal Bandwidth	BW <sub>-3dB</sub>			600		kHz
Input Resistance	$R_{IN}$	Either differential input		100		k $\Omega$
Input Resistance Match	$R_{MATCH}$			1		%
Input Noise-Voltage Density	$e_n$	$A_V = 10V/V$ , $f = 1kHz$		100		nV/ $\sqrt{Hz}$
		$A_V = 100V/V$ , $f = 1kHz$ , MAX4061/MAX4062 only		20		
RMS Output Noise Voltage	$V_{NRMS}$	$A_V = 10V/V$ , BW = 22Hz to 22kHz		125		$\mu V_{RMS}$

**Electrical Characteristics (continued)**

( $V_{CC} = 3V$  for MAX4061/MAX4062,  $V_{CC} = 5V$  for MAX4060,  $V_{GND} = 0V$ ,  $V_{\overline{SHDN}} = V_{CC}$ ,  $V_{\overline{INT/AUX}} = 0V$ ,  $R_G = 11.11k\Omega$ ,  $R_L = 100k\Omega$  to  $1.5V$ ,  $R_{BIAS} = \infty$ ,  $T_A = T_{MIN}$  to  $T_{MAX}$ , unless otherwise noted. Typical values are at  $T_A = +25^\circ C$ .) (Notes 1, 2)

PARAMETER	SYMBOL	CONDITIONS	MIN	TYP	MAX	UNITS	
Total Harmonic Distortion Plus Noise	THD+N	$A_V = 10V/V$ , $f = 1kHz$ , $V_{OUT} = 0.7V_{RMS}$ , $BW = 22Hz$ to $22kHz$		0.04		%	
Differential Gain	$A_{VDIFF}$	$1V < V_{CM} < 2V$ , $V_{OUT} = 0.7V_{RMS}$ , MAX4061/MAX4062	$R_G = open$	1	1.13	1.3	V/V
			$R_G = 11.11k\Omega$	9.6	10	10.4	
			$R_G = 1.01k\Omega$	96	100	104	
		$1V < V_{CM} < 2V$ , $V_{OUT} = 0.7V_{RMS}$ , MAX4060		9.6	10.0	10.4	
Common-Mode Rejection Ratio	CMRR	$V_{CM} = 500mV_{P-P}$ , $f = 1kHz$		70		dB	
Power-Supply Rejection Ratio	PSRR	$T_A = +25^\circ C$		72	89	dB	
		$T_A = T_{MIN}$ to $T_{MAX}$		60			
		$V_{CC} = 5V \pm 100mV$ , $f = 1kHz$			86		
<b>AUXILIARY INPUT (MAX4060/MAX4062, INT/AUX = <math>V_{CC}</math>)</b>							
Small-Signal Bandwidth	$BW_{-3dB}$			200		kHz	
Input Resistance	$R_{IN}$			100		k $\Omega$	
Input Noise-Voltage Density	$e_n$	$f = 1kHz$		45		nV/ $\sqrt{Hz}$	
RMS Output Noise Voltage	$V_{NRMS}$	$BW = 22Hz$ to $22kHz$		385		$\mu V_{RMS}$	
Total Harmonic Distortion Plus Noise	THD+N	$f = 1kHz$ , $BW = 22Hz$ to $22kHz$		0.05		%	
Power-Supply Rejection Ratio	PSRR	$T_A = +25^\circ C$		65	90	dB	
		$T_A = T_{MIN}$ - $T_{MAX}$		50			
Voltage Gain	$A_{VAUX}$	$V_{OUT} = 0.7V_{RMS}$	-10.7	-10	-9.3	V/V	
<b>BIAS OUTPUT (MAX4060/MAX4062)</b>							
Output Voltage	$V_{OUT}$	$I_{BIAS} = 0.8mA$ to GND, MAX4060	2	2.2		V	
		$I_{BIAS} = 0.5mA$ to GND, MAX4062	2	2.2			
Output Resistance	$R_{OUT}$	$I_{BIAS} = 0.8mA$ to GND, MAX4060 ( $T_A = +25^\circ C$ )	2	2.5		k $\Omega$	
		$I_{BIAS} = 0.5mA$ to GND, MAX4062 ( $T_A = +25^\circ C$ )		22	40	$\Omega$	
Output Noise Voltage	$V_{NRMS}$	$I_{BIAS} = 0.8mA$ to GND, $BW = 22Hz$ to $22kHz$ , MAX4060		50		$\mu V_{RMS}$	
		$I_{BIAS} = 0.5mA$ to GND, $BW = 22Hz$ to $22kHz$ , MAX4062		20			

**Electrical Characteristics (continued)**

( $V_{CC} = 3V$  for MAX4061/MAX4062,  $V_{CC} = 5V$  for MAX4060,  $V_{GND} = 0V$ ,  $V_{\overline{SHDN}} = V_{CC}$ ,  $V_{\overline{INT}/AUX} = 0V$ ,  $R_G = 11.11k\Omega$ ,  $R_L = 100k\Omega$  to  $1.5V$ ,  $R_{BIAS} = \infty$ ,  $T_A = T_{MIN}$  to  $T_{MAX}$ , unless otherwise noted. Typical values are at  $T_A = +25^\circ C$ .) (Notes 1, 2)

PARAMETER	SYMBOL	CONDITIONS		MIN	TYP	MAX	UNITS
Power-Supply Rejection Ratio	PSRR	MAX4060	$I_{BIAS} = 0.8mA$ to GND, $V_{CC} = 4.5V$ to $5.5V$	50	80		dB
			$I_{BIAS} = 0.8mA$ , $V_{CC} = 5V$ + $100mV_{P-P}$ , $f = 1kHz$		70		
		MAX4062	$I_{BIAS} = 0.5mA$ to GND, $V_{CC} = 2.4V$ to $5.5V$	50	74		
			$I_{BIAS} = 0.5mA$ , $V_{CC} = 3V$ + $100mV_{P-P}$ , $f = 1kHz$		71		
<b>DIGITAL INPUTS</b> ( $\overline{SHDN}$ for MAX4061 and $\overline{INT}/AUX$ for MAX4060/MAX4062)							
Input Leakage Current	$I_{IN}$	$V_{IN} = 0V$ or $V_{CC}$				$\pm 1$	$\mu A$
Input-Voltage High	$V_{INH}$			$0.7 \times V_{CC}$			V
Input-Voltage Low	$V_{INL}$					$0.3 \times V_{CC}$	V
Shutdown Enable Time	$t_{ON}$	MAX4061			10		$\mu s$
Shutdown Disable Time	$t_{OFF}$	MAX4061			10		$\mu s$

**Note 1:** All specifications are 100% tested at  $T_A = +25^\circ C$ . Specification limits over temperature ( $T_A = T_{MIN}$  to  $T_{MAX}$ ) are guaranteed by design, not production tested.

**Note 2:** MAX4062 requires a  $1\mu F$  capacitor from BIAS to ground.

Typical Operating Characteristics

( $V_{CC} = 3V$  (MAX4061/MAX4062),  $V_{CC} = 5V$  for MAX4060,  $A_V = 10V/V$ ,  $R_L \geq 100k\Omega$  to  $1.5V$ ,  $\overline{SHDN} = V_{CC}$  (MAX4061 only),  $T_A = +25^\circ C$ , unless otherwise noted.)

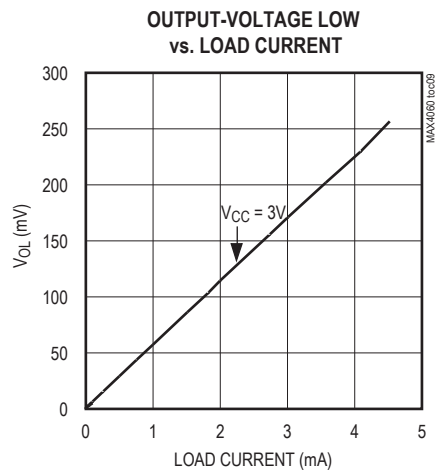
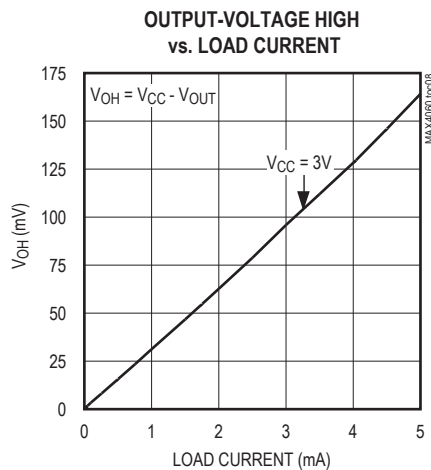
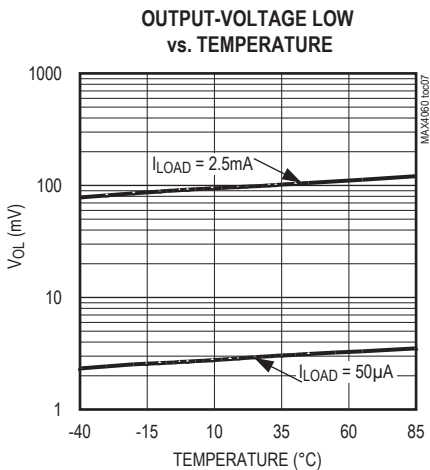
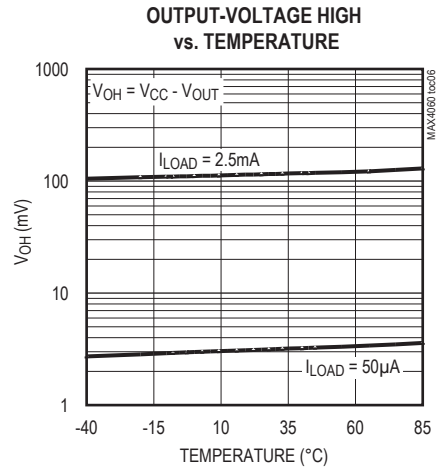
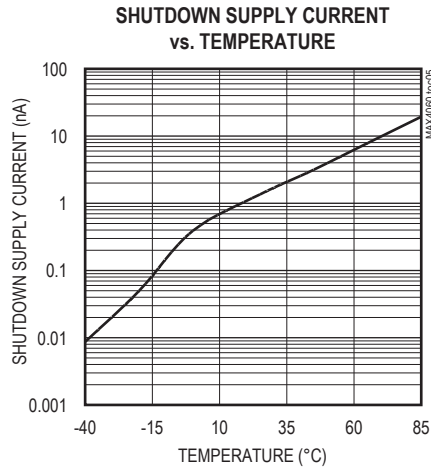
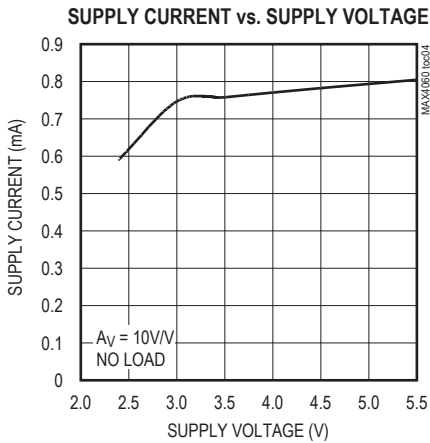
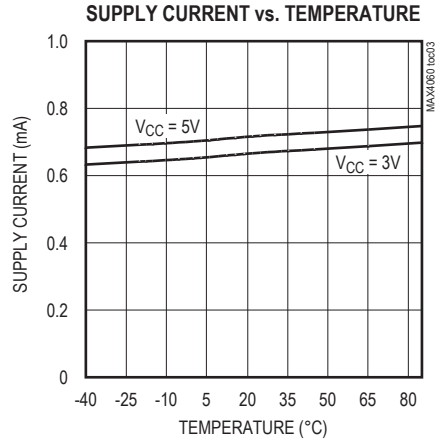
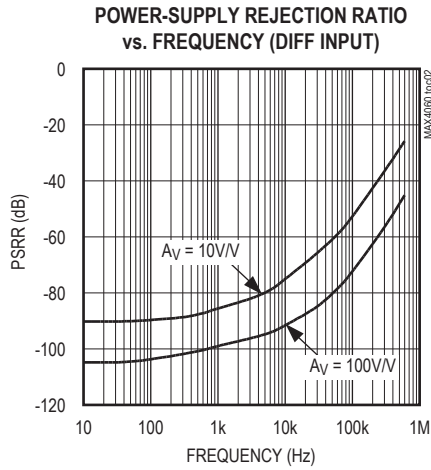
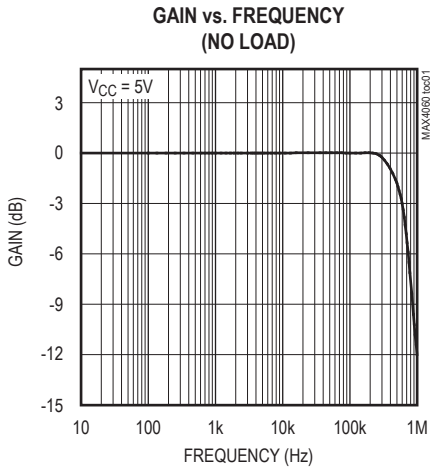

Typical Operating Characteristics (continued)

( $V_{CC} = 3V$  (MAX4061/MAX4062),  $V_{CC} = 5V$  for MAX4060,  $A_V = 10V/V$ ,  $R_L \geq 100k\Omega$  to  $1.5V$ ,  $\overline{SHDN} = V_{CC}$  (MAX4061 only),  $T_A = +25^\circ C$ , unless otherwise noted.)

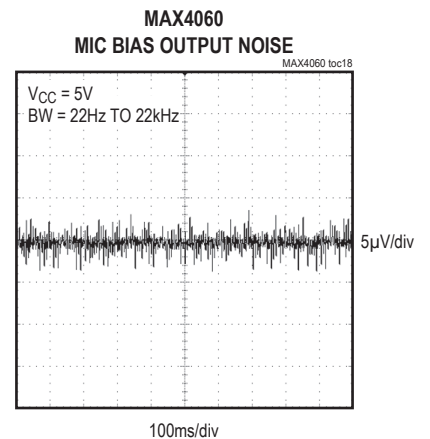
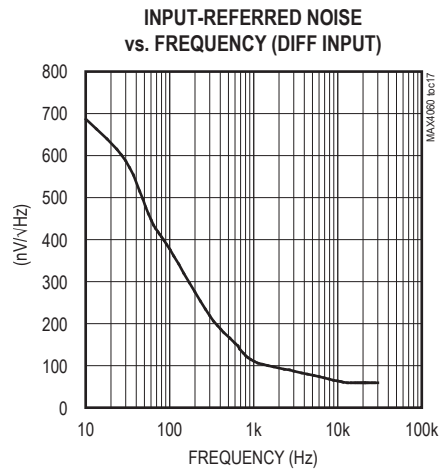
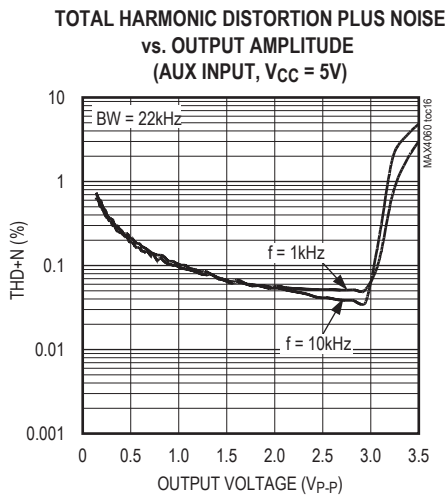
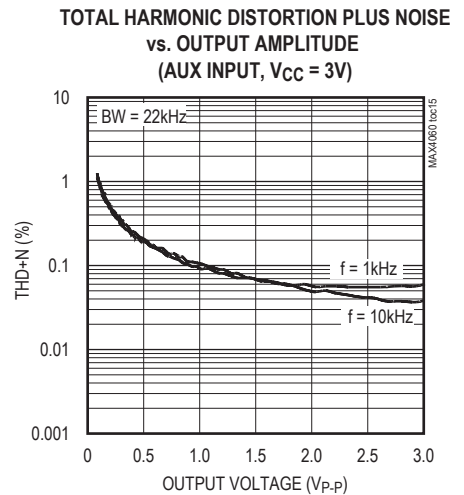
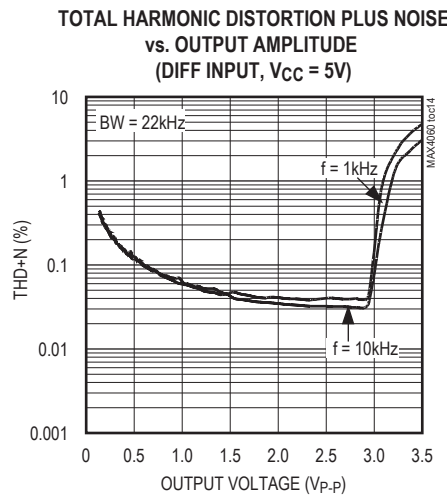
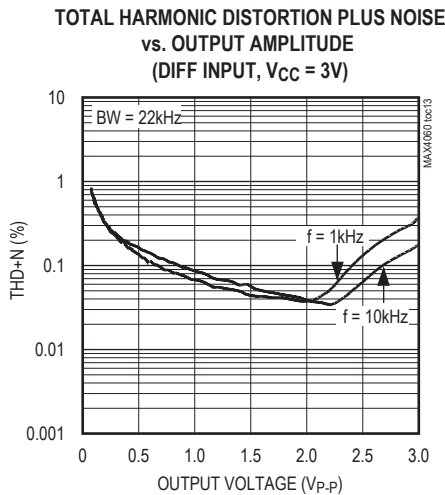
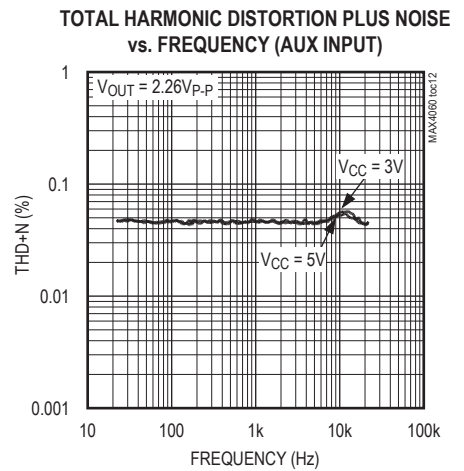
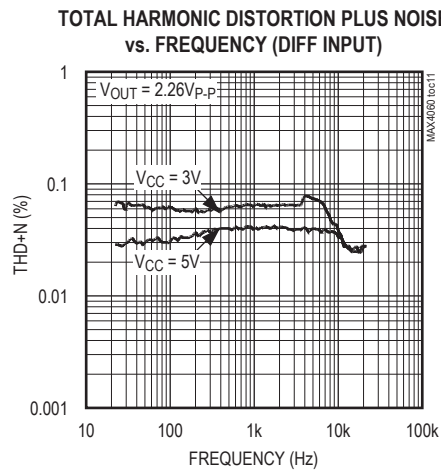
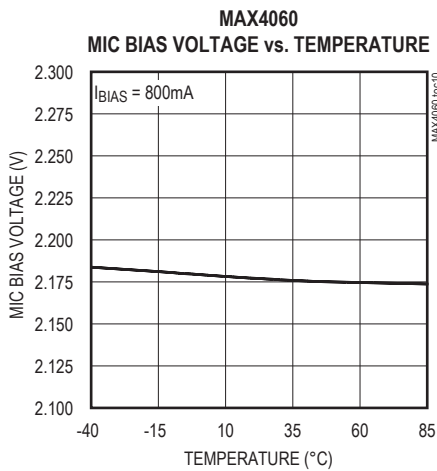

**Typical Operating Characteristics (continued)**

( $V_{CC} = 3V$  (MAX4061/MAX4062),  $V_{CC} = 5V$  for MAX4060,  $A_V = 10V/V$ ,  $R_L \geq 100k\Omega$  to  $1.5V$ ,  $\overline{SHDN} = V_{CC}$  (MAX4061 only),  $T_A = +25^\circ C$ , unless otherwise noted.)

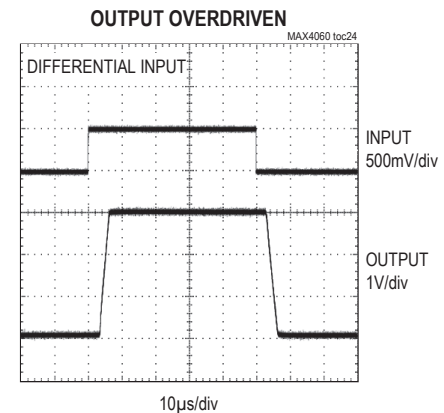
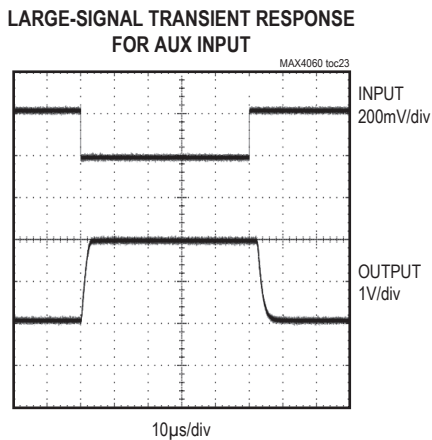
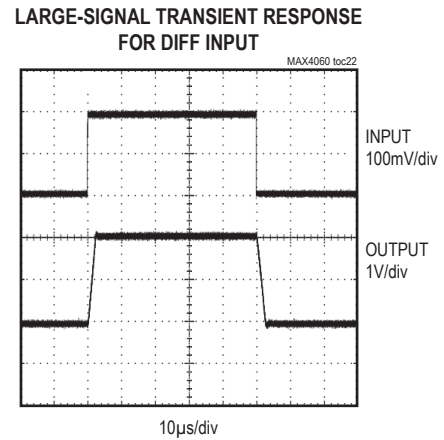
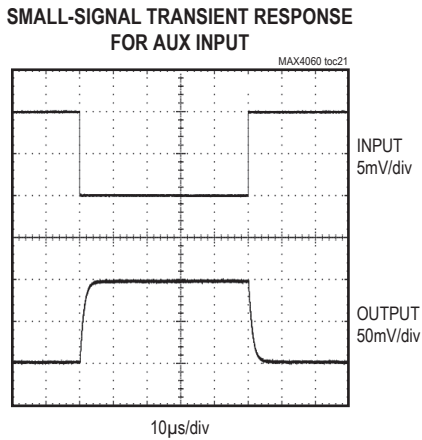
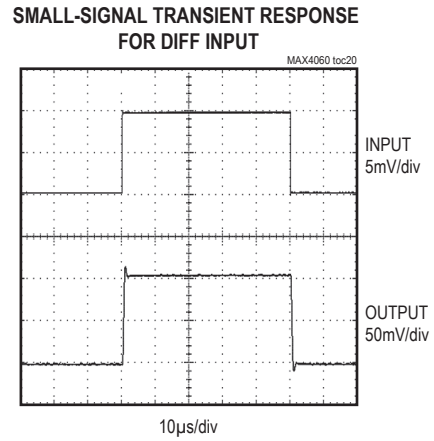
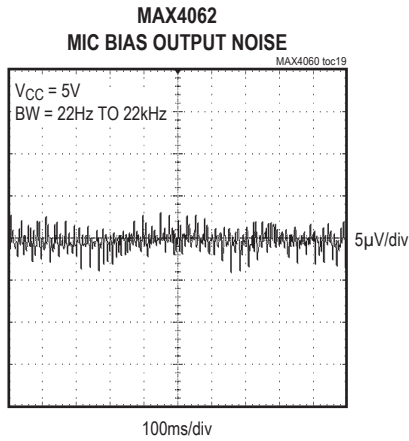

## Pin Description

PIN			NAME	FUNCTION
MAX4060	MAX4061	MAX4062		
1	—	2	$\overline{\text{INT}}/\text{AUX}$	Internal (Differential) or Auxiliary (Single-Ended) Input Select. Drive $\overline{\text{INT}}/\text{AUX}$ low to select internal or high to select auxiliary microphone input.
2	3	3	OUT	Amplifier Output. OUT is high impedance when in shutdown mode.
3	—	—	BIAS	External Electret Microphone Capsule Bias Output. BIAS has a greater than 2k $\Omega$ output impedance.
4	4	5	V <sub>CC</sub>	Power Supply. Bypass the V <sub>CC</sub> to GND with a 0.1 $\mu$ F capacitor.
5	5	6	IN+	Noninverting Differential Amplifier Input. AC-couple the audio signal into IN+.
6	6	7	IN-	Inverting Differential Amplifier Input. AC-couple the audio signal into IN-.
7	7	8	GND	Ground
8	—	9	AUX_IN	Single-Ended Input for Auxiliary Microphone. AC-couple the audio signal into AUX_IN.
—	1	1	G2	Gain-Selectable Input. Connect an external resistor between G1 and G2 to set the gain for the differential amplifier. (See <i>Adjustable Differential-Gain Setting</i> section.)
—	2	—	$\overline{\text{SHDN}}$	Shutdown Input. Drive $\overline{\text{SHDN}}$ high for normal operation. Drive $\overline{\text{SHDN}}$ low for shutdown mode.
—	—	4	BIAS	External Electret Microphone Capsule Bias Output. Bypass BIAS with 1 $\mu$ F capacitor to ground.
—	8	10	G1	Gain-Selectable Input. Connect an external resistor between G1 and G2 to set the gain for the differential amplifier.
—	—	—	EP	Exposed Pad (TDFN Only). Internally connected to GND. Connect to a large ground plane to minimize thermal performance. Not intended as an electrical connection point.

## Detailed Description

The MAX4060/MAX4061/MAX4062 are differential microphone preamplifiers providing high-quality audio, optimized for use in computer and mobile applications. These devices feature rail-to-rail outputs, very high power-supply rejection, and common-mode rejection, making them ideal for low-noise applications. The MAX4060/MAX4061/MAX4062 are particularly effective when layout constraints force the microphone amplifier to be physically remote from the ECM microphone and/or the rest of the audio circuitry.

The MAX4060/MAX4062 are capable of switching their output between the differential input and an inverting single-ended input.  $\overline{\text{INT}}/\text{AUX}$  selects either the differential input or single-ended auxiliary input. In addition, the MAX4060 has an internal bias generator to bias the microphone in either differential or single-ended modes. The MAX4061 includes a complete 0.3 $\mu$ A shutdown

mode for ultimate power savings. The differential gain of the MAX4061/MAX4062 is set with a single resistor connected between the G1 and G2 pins. The MAX4060 has a fixed gain of 10V/V.

### Differential Input

The main microphone input is a low-noise, differential input structure. This is an almost essential element when faced with amplification of low-amplitude analog signals in digitally intense environments such as notebook PCs or PDAs. Used correctly, the advantages over a single-ended solution are:

- Better power-supply noise rejection.
- Less degradation from noise in PC board ground planes.
- The microphone and preamplifier can be placed physically further apart, easing PC board layout restrictions.



## Functional Diagram

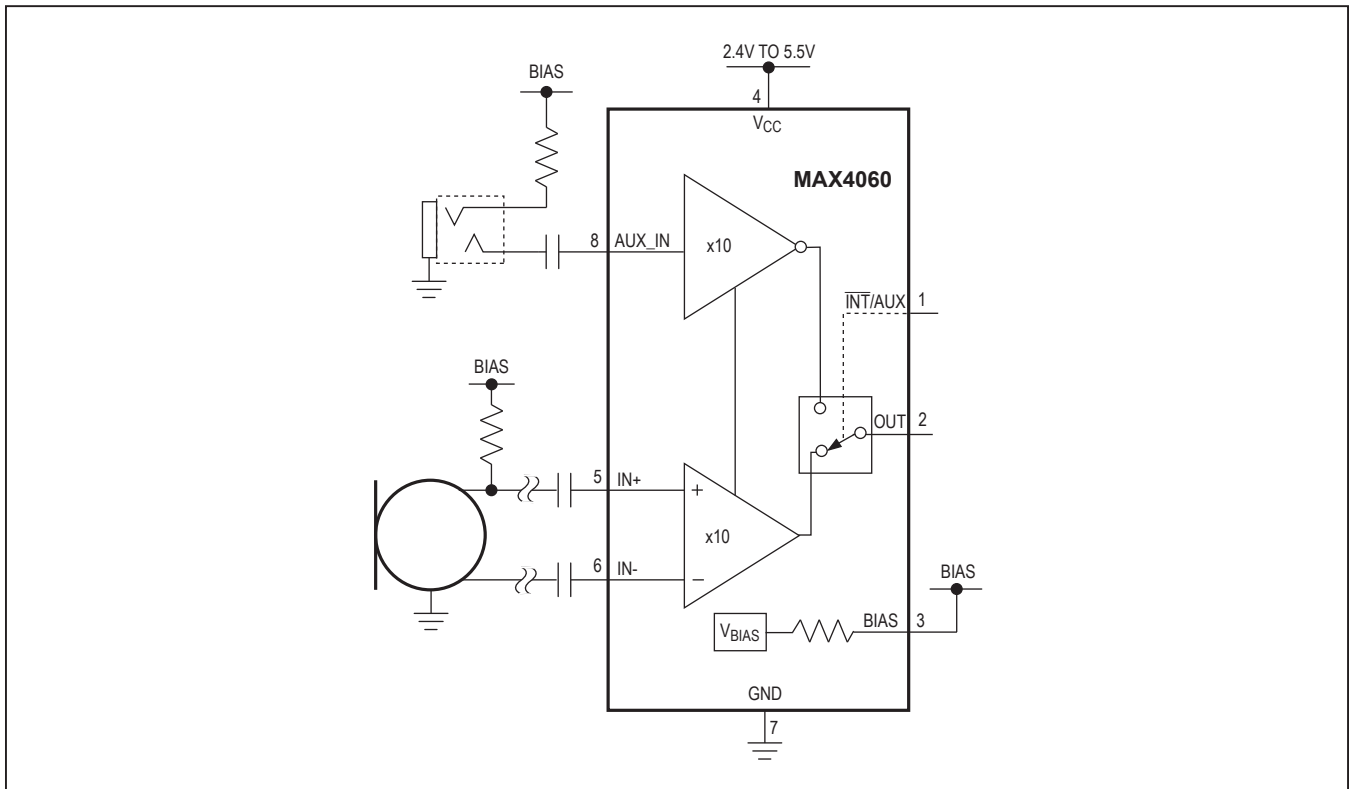

### Fixed Differential Gain (MAX4060)

The MAX4060 has an internal fixed gain of 10V/V for its differential input. This feature simplifies design, reduces pin count, footprint, and eliminates external gain-setting resistors.

### Adjustable Differential-Gain Setting

The MAX4061/MAX4062 allow the user to alter the gain to optimize the signal-to-noise ratio (SNR) of their system. The gain is set by a single external resistor ( $R_G$ ) connected between the G1 and G2 pins, where:

$$R_G = 100\text{k}\Omega / (A_V - 1)$$

where  $A_V$  is the required voltage gain.

Hence, an 11.11k $\Omega$  resistor yields a gain of 10V/V, or 20dB. Leaving the pins unconnected results in a gain of 1V/V. Gain for the MAX4061/MAX4062 is defined as:

$$A_V = V_{OUT} / (V_{IN+} - V_{IN-})$$

The resistor can be either fixed or variable, allowing the use of a digitally controlled potentiometer to alter the gain under software control.

### Input Capacitors

The two differential microphone inputs and the single-ended auxiliary input of the MAX4060/MAX4061/MAX4062 have on-chip bias components, allowing the user to AC-couple any signals onto the input. The input resistance is 100k $\Omega$  (typ), so the capacitor size may be chosen accordingly to define the LF rolloff desired. This can be calculated as:

$$C_{IN} = 1 / (2\pi f_{CUT} R_{IN})$$

This assumes a low source impedance driving the inputs.

A further consideration for the differential input is the effect of these series input capacitors on low-frequency, common-mode rejection. Any mismatch in the values of these two capacitors degrades the CMRR at frequencies where the impedance of the capacitor is significant compared to the input resistance of the amplifier—this is usually most noticeable at low frequencies. One way to avoid the need for matched or tight tolerance capacitors is to deliberately oversize the values on the differential

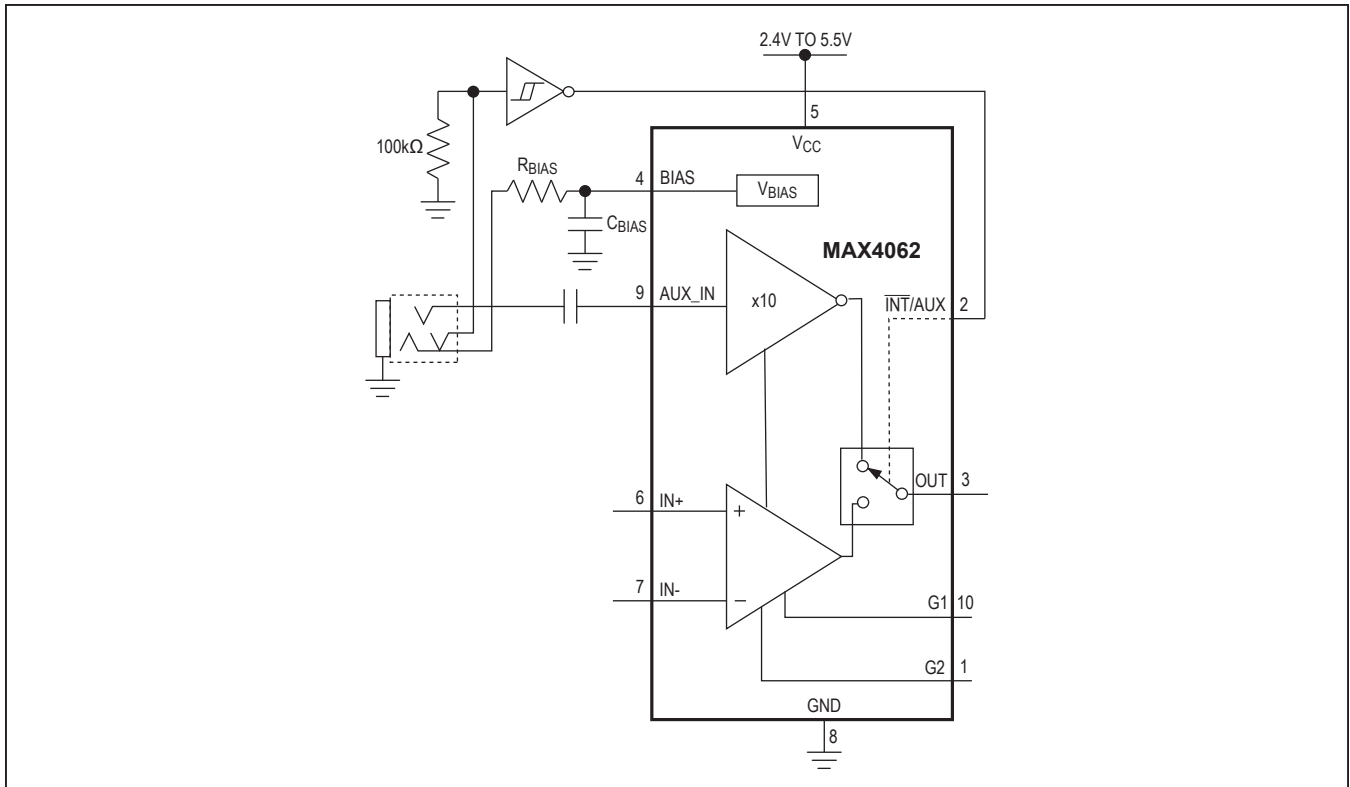

Figure 1. MAX4062 with Auxiliary Input Configuration

inputs and to set the lower 3dB point ( $f_{CUT}$ ) of the amplifier by sizing the output capacitor appropriately.

The input impedance matching on the differential input is typically 1%, allowing input capacitor matching to be effective at improving low-frequency PSRR.

### Common-Mode Rejection Ratio

The common-mode rejection ratio (CMRR) refers to the amount of rejection that the amplifier is capable of providing to any signal applied equally to the IN+ and IN- inputs. In the case of amplifying low-level microphone signals in noisy digital environments, it is a key figure of merit. In audio circuits, this is generally measured for  $V_{IN}$  as an AC signal:

$$CMRR(dB) = A_{DM} / A_{CM}$$

where  $A_{DM}$  is the differential gain,  $A_{CM}$  is the common-mode gain.

Input voltages are sufficiently small such that the output is not clipped in either differential or common-mode application. The topology used in the MAX4061/MAX4062 means that the CMRR actually improves at higher differential gains—another advantage of using differential sensing.

### Auxiliary Input

The auxiliary input is a single-ended input intended to be used with a jack-socket-type microphone input (Figure 1). Internal DC-bias components (as on the main inputs) allow the input signal to be AC-coupled. Mechanically switched jack sockets can be used in conjunction with the  $\overline{INT}/AUX$  select pin, allowing the auxiliary microphone input to be automatically selected when a jack socket is inserted.

### Microphone Bias Voltage

#### MAX4060

The MAX4060 has a microphone bias voltage designed to comply with the Microsoft/Intel PC99/2001 audio standard. It features source impedance of greater than 2kΩ, and delivers more than 2V of bias when loaded with a current of 800μA. This limits operation of this part to supplies between 4.5V to 5.5V (see Figure 2).

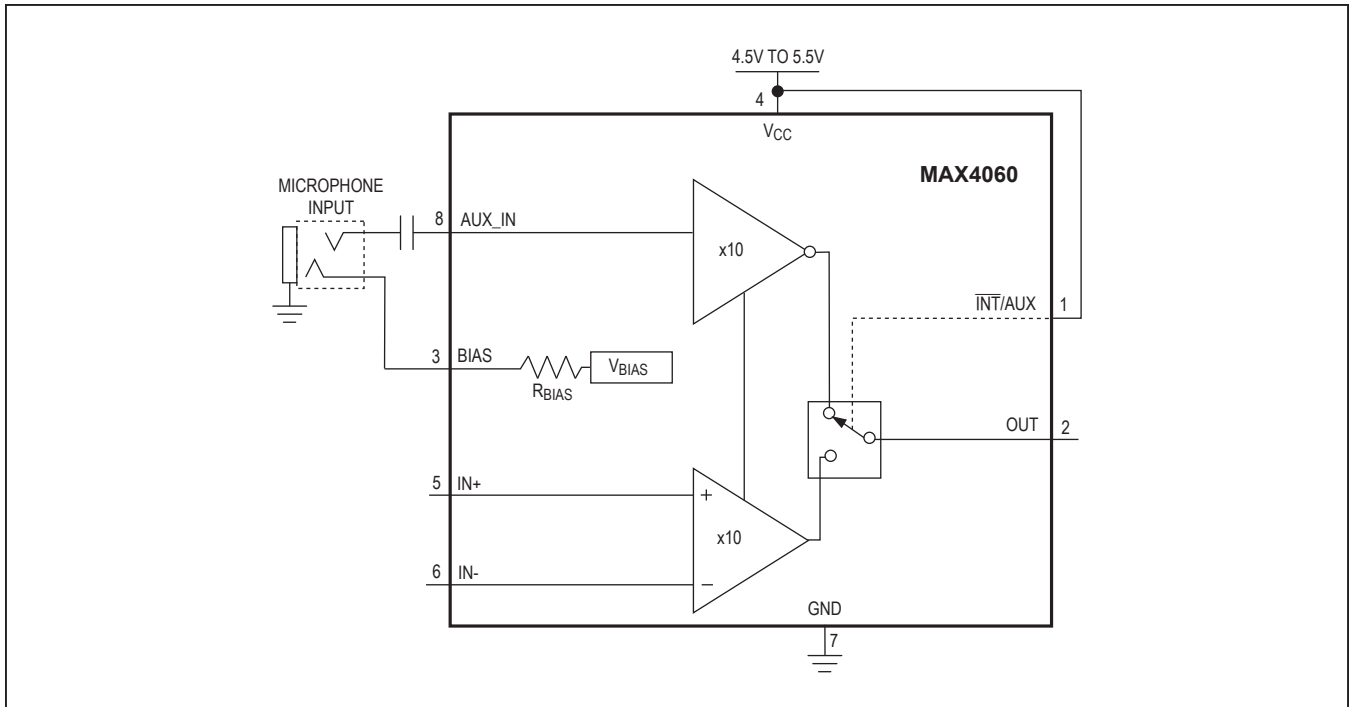

Figure 2. MAX4060 Used for Biasing a Microphone

### MAX4061/MAX4062

The MAX4062 has a lower bias voltage and low-impedance outputs (optimum electret bias resistor can then be set externally). This gives a low-noise, flexible solution that can run from 2.4V to 5.5V, suitable for handheld devices such as PDAs that typically have audio power supplies in the 3V region (see Figure 3).

In applications where the differential microphone is placed some distance from the MAX4060/MAX4061/MAX4062, using a remote differential bias scheme as shown in Figure 4 can provide improved noise rejection.

### Output

#### MAX4060/MAX4061 DC Bias

The output voltage has a DC-bias voltage independent of the power supplies, resulting in superior PSRR performance. The MAX4061 output is high impedance when the part is in shutdown mode. AC-coupling the output into the next audio stage (e.g., CODEC) is recommended.

## Applications Information

### Shutdown Mode

The MAX4061 features a low-power, complete shutdown mode. When  $\overline{\text{SHDN}}$  goes low, the supply current drops to 0.3 $\mu\text{A}$ , the output enters a high-impedance state, and the bias current to the microphone is switched off. Driving  $\overline{\text{SHDN}}$  high enables the amplifier.  $\overline{\text{SHDN}}$  should not be left unconnected.

### Power Supplies and Layout

The MAX4060 operates from a 4.5V to 5.5V single supply and the MAX4061/MAX4062 operate from a 2.4V to 5.5V single supply. Bypass the power supply with a 0.1 $\mu\text{F}$  capacitor to ground. In systems where analog and digital grounds are available, the MAX4060/MAX4061 should be connected to the analog ground.

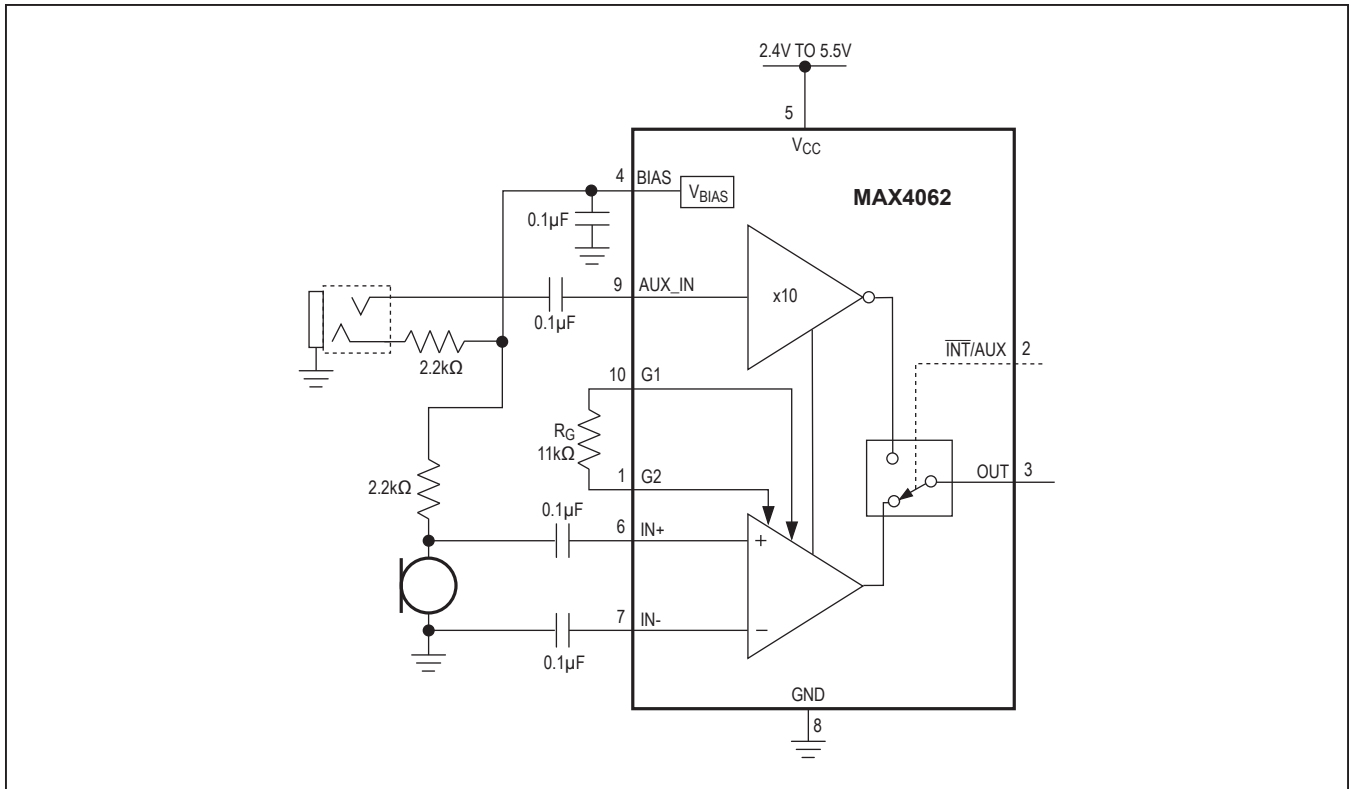

Figure 3. MAX4062 Used to Bias a Microphone Connected to the Auxiliary Input and the Differential Input

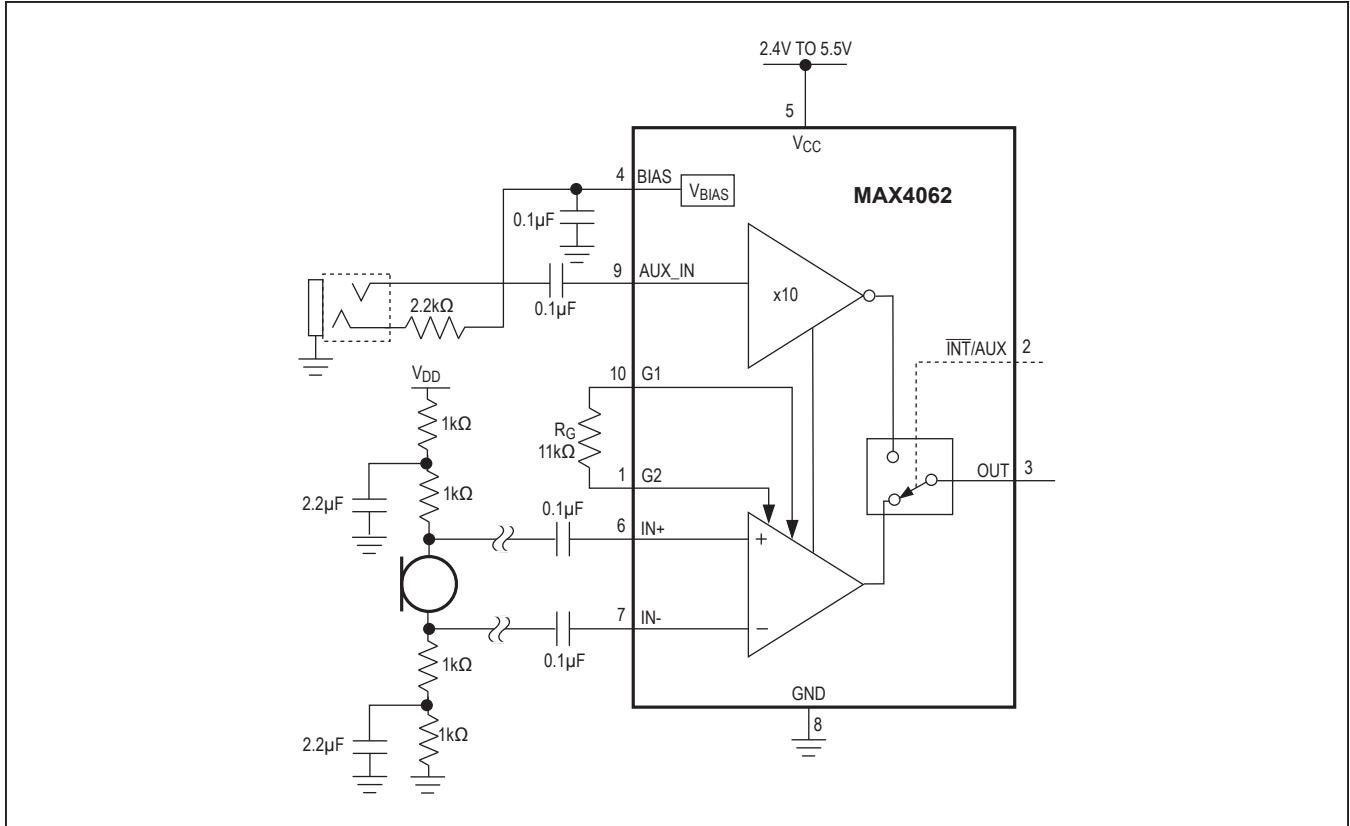
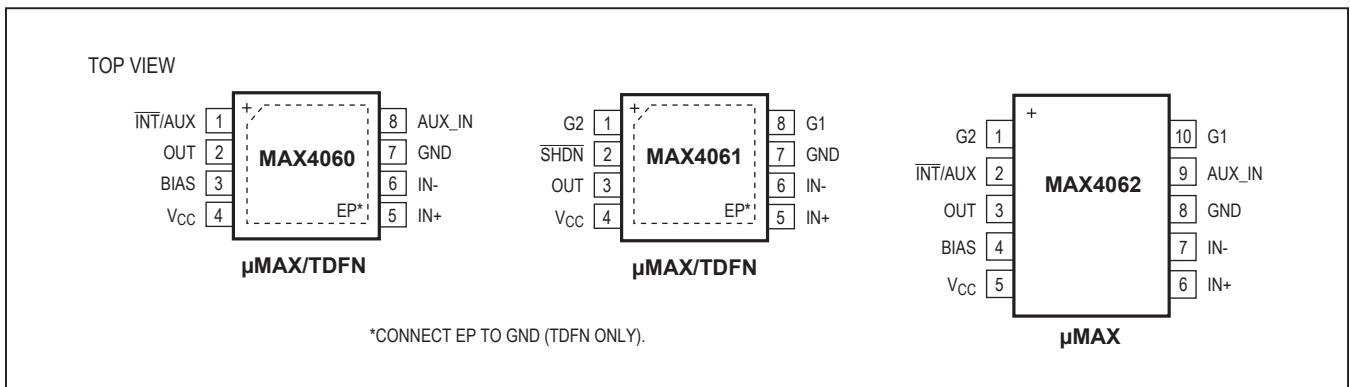
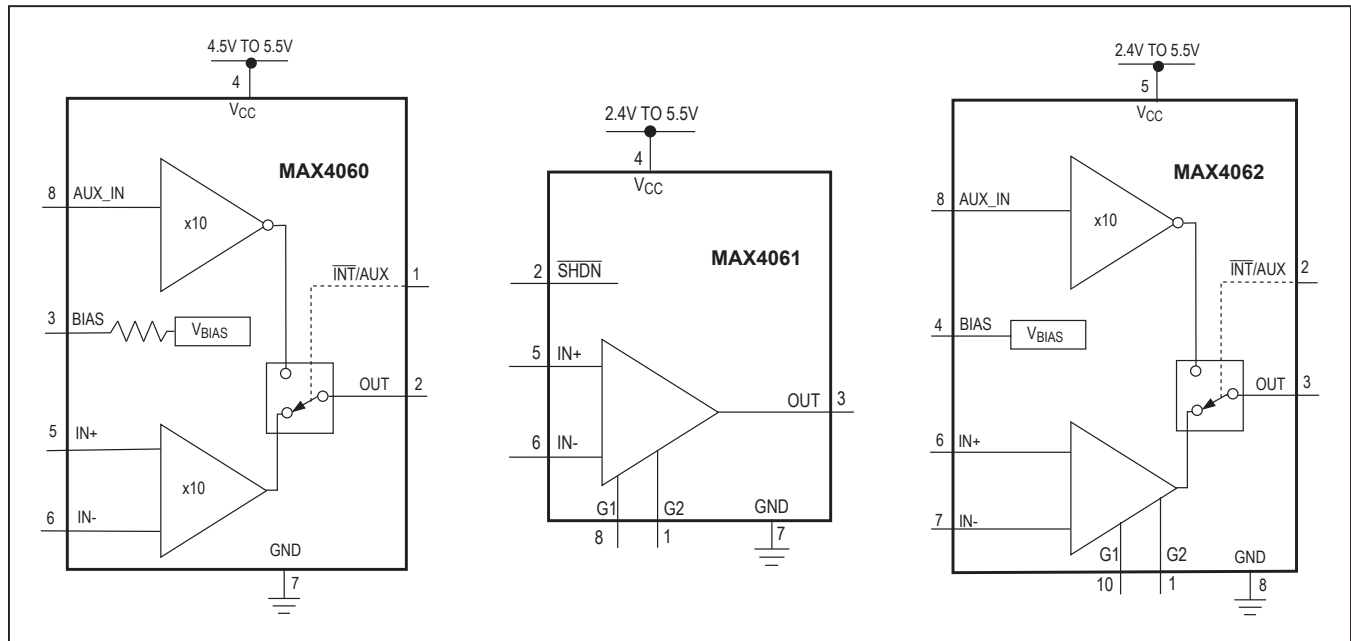

Figure 4. Remote Differential Microphone Bias Network Optimizes Noise Rejection in Long-Run, PC Board Traces

## Pin Configurations



## Block Diagrams



## Selector Guide

PRODUCT*	AUXILIARY INPUT	DIFF INPUT GAIN	SINGLE-ENDED INPUT GAIN (dB)	MICROPHONE BIAS	SHUTDOWN MODE	SUPPLY VOLTAGE (V)
MAX4060	✓	20dB	20	✓	—	4.5 to 5.5
MAX4061	—	ADJ	—	—	✓	2.4 to 5.5
MAX4062	✓	ADJ	20	✓	—	2.4 to 5.5

\*See Block Diagrams.

## Chip Information

PROCESS: BiCMOS

## Package Information

For the latest package outline information and land patterns (footprints), go to [www.maximintegrated.com/packages](http://www.maximintegrated.com/packages). Note that a "+", "#", or "-" in the package code indicates RoHS status only. Package drawings may show a different suffix character, but the drawing pertains to the package regardless of RoHS status.

PACKAGE TYPE	PACKAGE CODE	DOCUMENT NO.	LAND PATTERN NO.
8 TDFN	T833+2	<a href="#">21-0137</a>	<a href="#">90-0059</a>
8 $\mu$ MAX	U8+1	<a href="#">21-0036</a>	<a href="#">90-0092</a>
10 $\mu$ MAX	U10+2	<a href="#">21-0061</a>	<a href="#">90-0330</a>