

MAX4146x Evaluation Kit

Evaluates: **MAX41460**
MAX41463
MAX41464

General Description

The MAX4146x evaluation kit (EV kit) contains a single MAX4146x high output power VHF/UHF sub-GHz ISM/SRD transmitter, designed to transmit Frequency-Shift Keying (FSK), Gaussian GFSK or Amplitude-Shift Keying (ASK) data in the 286MHz to 960MHz frequency range.

The MAX41460 and the MAX41461–MAX41464 evaluation kits operate in conjunction with an external microcontroller (MCU) and Graphical User Interface (GUI) software running on a computer. The MAX41460 uses an SPI interface for internal register configurations while the MAX41461–MAX41464 can use the preset modes or an I²C interface for register programming and control.

The MAX41461, MAX41462, MAX41463, and MAX41464 evaluation kits are also designed to operate with a simple, one-pin data interface, alleviating the need to program the part for nominal operation, or other high-level system (PC with GUI software) having to configure the transmitter for operation. These parts allow the user to preset the operating frequencies by part selection and pin configurations. On the evaluation kit, selecting the frequency of operation is as simple as setting two jumpers.

The EV kit includes Windows® 7/10-compatible software that provides a simple graphical user interface (GUI) for configuration of all the MAX4146x registers through the SPI or I²C ports. The GUI also controls the on-board PMIC and can act as a data generator, when the MAX32630FTHR Applications Platform is used.

Features

- Evaluates the MAX4146x Family of Sub-1GHz ISM Transmitters
- Single Input Voltage Supply from 1.8V to 3.6V
- Direct Interface with a MAX32630FTHR ARM Microcontroller (MCU) Board
- Available Pmod Hardware Interface
- Windows 7/10-compatible Software
- On-Board SPI Interface Control for the MAX41460 and optional I²C Control for the MAX41461–MAX41464
- GUI Controls for MAX32630FTHR Board PMIC Operation from 1.8V to 3.3V
- Proven 2-Layer PCB Design
- Fully Assembled and Tested

Ordering Information appears at end of data sheet.

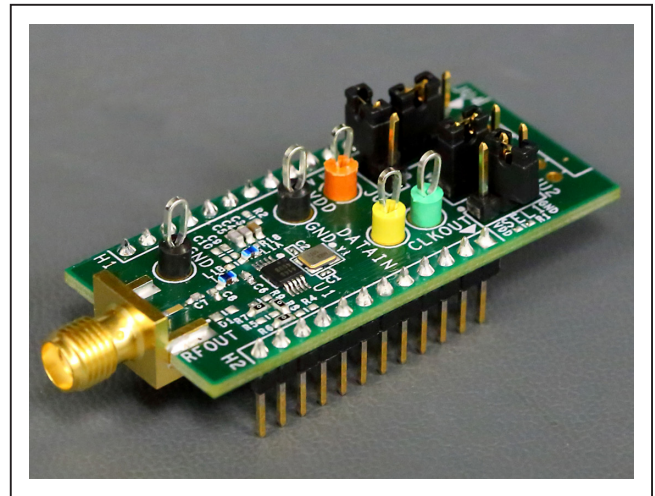

Figure 1. MAX4146x EV Kit Board

Windows is a registered trademarks and registered service marks of Microsoft Corporation.

Quick Start

Required Equipment

- **Included in the MAX4146x Evaluation Kit**
 - MAX4146x Evaluation kit board
 - MAX32630FTHR# kit
 - FTHR board
 - DAPLINK board
 - 2x micro/B USB cables
 - MAX4146x EV kit Pin Diagram Card
- Windows PC* (Win-7/Win-10), with one to two USB2.0 ports available
- Power Supply† capable of 1.8V to 3.6V, 100mA
- Serial Data Source† and a simple means of connection (DATA test point and Ground)
- Basic Spectrum Analyzer – Rohde and Schwarz ZVL3, Tektronix RSA306, or equivalent
- SMA/SMA cable as needed for connection to the spectrum analyzer

Software and Drivers

The MAX4146x EV kit can be used in conjunction with the ARM Cortex-M4F microcontroller MAX32630FTHR Application Platform or “FTHR” board to provide power and control the device through a software application or Graphical User Interface (GUI). For this option, additional equipment is required:

When connected to the FTHR board the MAX4146x EV kit uses the following drivers and software components. Refer to the [Appendix I](#) for additional information on this installation process.

- **MAX4146x Software Package**

The software, firmware, and drivers are available from the www.maximintegrated.com website. Login to your MyMaxim account on the website, search for the MAX4146x part or EVKIT, click on the “Design Resources” tab, and click on the appropriate software link. Finally, click the file link on the software landing page to download the MAX4146x EV kit package.
- **mBed MAX32630FTHR and DAPLINK Interface System**

The DAPLINK system should not be required unless a firmware update to the FTHR board has been released. The FTHR board included in the MAX4146X

EV kit will be preprogrammed for interfacing the GUI to the radio. The firmware programming process does not require additional software or drivers, it uses a simple USB drive, drag-and-drop file interface.

It is highly recommended that the target PC be connected to a local area network and have access to the Internet, this allows for automatic download and updates of some drivers. This process may take 15 minutes or more to complete.

Installation Procedure

The steps in this section are used when connecting the MAX4146x EV kit to a FTHR board and should only be needed once, when configuring the hardware and the PC for the first time. If these steps have already been completed, jump directly to the [FTHR Board Quick Start Procedure](#).

Install the MAX4146x EV Kit GUI Software

This process should take less than 10 minutes after downloading the software package. Refer to [Appendix I](#) for detailed information on this installation process.

- 1) Copy the “**Setup MAX4146X V1.0.0 EVKit SW.rar**” file to a working folder on the target PC.
- 2) Extract the setup file contents into the working directory.
- 3) Double-Click the “MAX4146xGUISetupV01.ms” setup file and follow Setup Wizard prompts.
 - a. Click <Next> in the MAX4146X Setup Wizard window.
 - b. It is recommended to use the default Destination Folder; click <Next> to continue.
 - c. Install the software by clicking the <Install> button.
 - d. Click <Finish> when the MAX4146X Setup Wizard installation process is complete.

Table 1. MAX4146x EV Kit Installed Files and Folders

FILE NAME	DESCRIPTION
MAX4146x.exe	Application GUI
MaximStyle.dll	Supporting DLL file for software operation
RegisterSet8.xml	Register definition file

* Required for operation of the MAX4146x EV kit with the GUI software.
 † Required when the FTHR board is not connected to the MAX4146x EV kit.

MAX4146x Evaluation Kit

Evaluates: MAX41460
MAX41463
MAX41464

Update the MAX32630FTHR Board Driver on the Host PC

No changes are needed for the FTHR board when first receiving a MAX4146x EV kit—the FTHR board has been pre-loaded with the required firmware. Updates to the driver on the host PC may be necessary depending on the operating system and whether the PC has access to the internet when first connecting to the FTHR board. Refer to [Appendix I](#) for detailed information on how to update the FTHR board firmware and the driver for the FTHR board/USB interface.

Hardware Use Procedure

Table 2. MAX4146x EV kit Jumper Settings

JUMPERS	POSITION	EV KIT FUNCTION	
JU1	1-2*	Power from L3OUT (FTHR board)	
	2-3	Power from PMOD interface (VDD, pin 6 of JU4)	
JU2	1-2	SEL1 to VDD	SEL1 – See Table 3 for preset modes
	2-3†	SEL1 to GND	
	Not Installed‡	SEL1 open	
JU3	1-2	SEL0 to VDD	SEL0 – See Table 3 for preset modes
	2-3†	SEL0 to GND	
	Not Installed‡	SEL0 open	
JU5	1-2†	I ² C pullup resistor R14 connected to VDD	
	3-4†	I ² C pullup resistor R15 connected to VDD	
	Not Installed*	Pullup resistors disconnected	

* default position

† setting for MAX41461-61 in I²C mode

‡ default for MAX41460

FTHR Board Quick Start Procedure—SPI and I²C Interface

Setup the MAX4146x EV kit and FTHR Board Hardware MCU/GUI Operation.

1. **Verify all jumpers on the MAX4146x EV kit board are in the default position;** refer to [Table 2](#).
 - a. For the MAX41460 EV kit, JU2, JU3 and JU5 should not be installed.
 - b. For MAX41461-MAX41464 EV kits, JU2 and JU3 must be installed 2-3 (SEL0 and SEL1 connected to GND); JU5 must be installed with jumpers from pins 1-2 and 3-4.
2. **Connect the MAX4146x EV kit to the FTHR board,** be sure the USB connector is oriented on the opposite side of the SMA connector, as shown in [Figure 3](#).

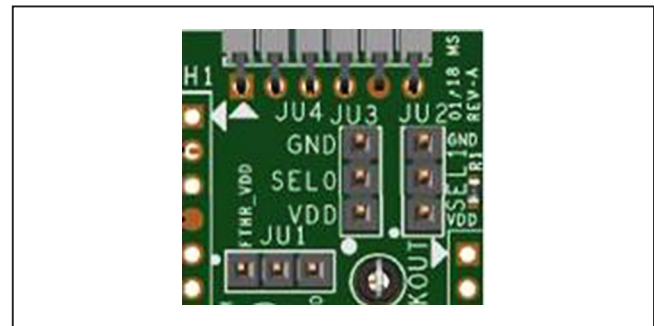

Figure 2. MAX4146x EV Kit Jumpers

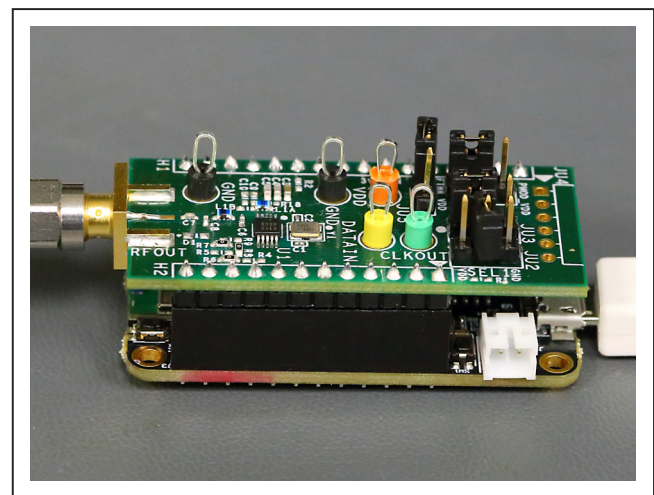

Figure 3. MAX4146x EV Kit Orientation to FTHR Board

MAX4146x Evaluation Kit

Evaluates: MAX41460
MAX41463
MAX41464

3. **Connect the FTHR Board to the PC** using a micro-B USB cable and observe a “heartbeat” on the FTHR board’s red LED.
4. **Connect the RF_OUT to a spectrum analyzer** using a low-loss SMA cable.
 - a. Set the Center Frequency to the target frequency of interest.
 - b. Set the Span to 1% of the Center Frequency (FCC standard test setting), the Resolution Bandwidth (RBW) to 1kHz, and the Video Bandwidth (VBW) to 3kHz.
 - c. Set the trace to “Max Hold”.
5. **Start the MAX4146x EV Kit Control Software GUI**
 - a. A MAX4146x EV kit splash screen, as shown in [Figure 4](#), will be displayed.
 - i. To disable future displays of the splash screen, click on the Disable check box.
 - ii. To continue to the GUI software, click on the <OK> button.
 - b. The expected COM port should be displayed if the EVK was connected prior to starting the GUI. Select the appropriate COM port from the drop-down list and click on the <Connect> button. The <Connect> button will change to the <Disconnect> button.
 - c. Confirm the firmware status bar has changed from “MAX4146X x.x.x” to “MAX4146X 0.1.0” or similar, the software LED is lit green, and the port status is noted as “Connected”.
 - d. Enter a supply level into the “Voltage” text box and click the <Set> button; for example, enter “3.0” for a 3.0V supply and click <Set>.

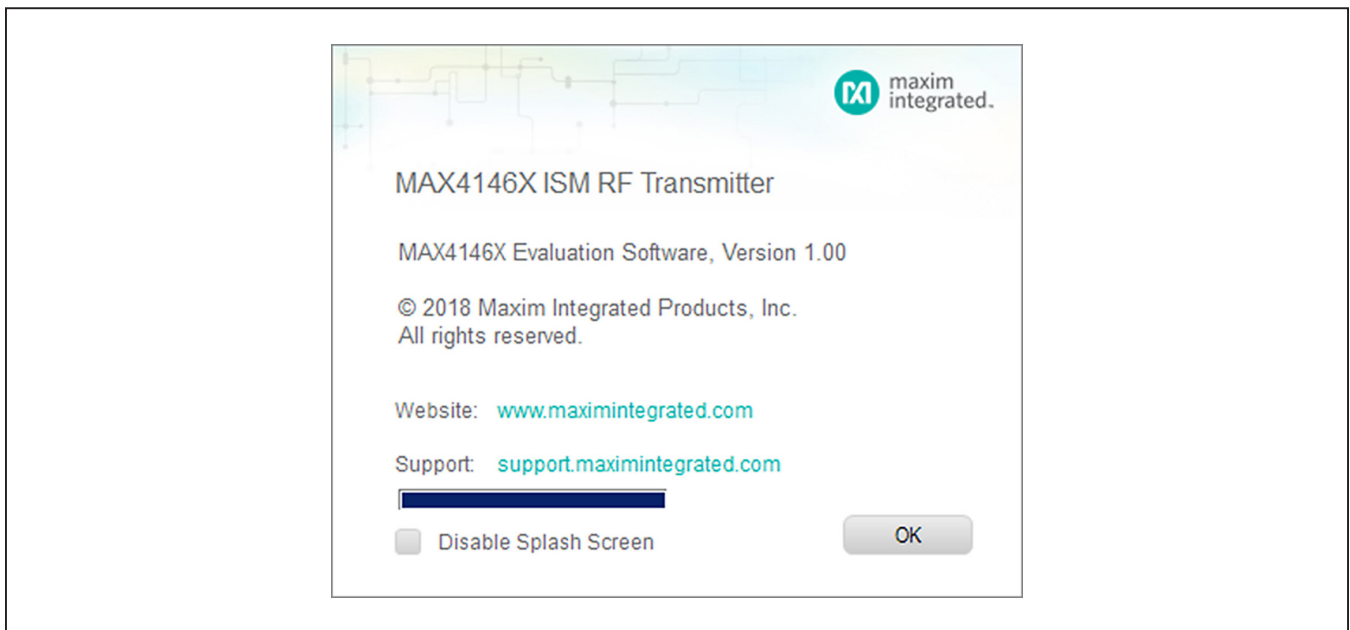

Figure 4. MAX4146x EV Kit GUI Splash Screen.

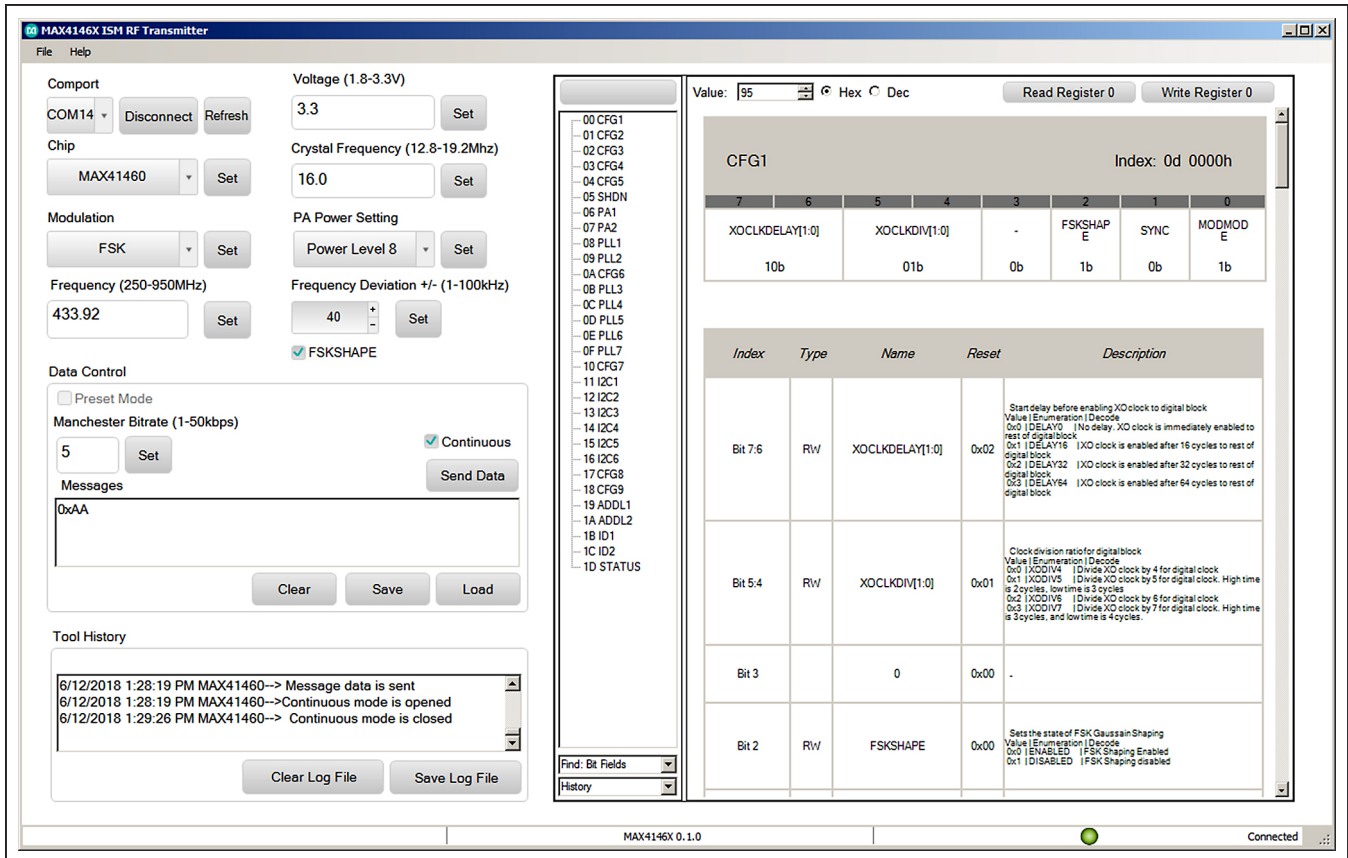

Figure 5. MAX4146x EV Kit GUI Software.

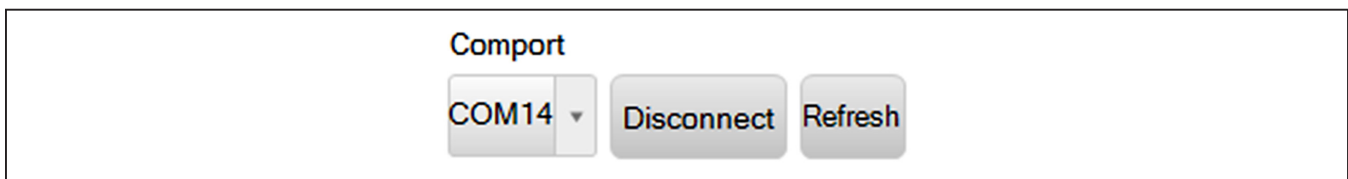

Figure 6. COM Port.

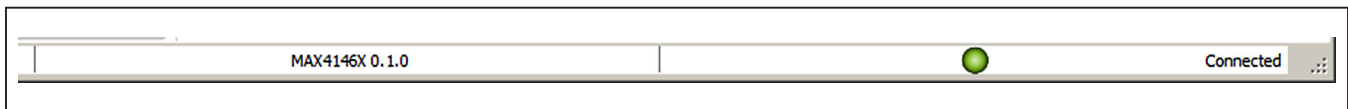

Figure 7. Connected Indicators.

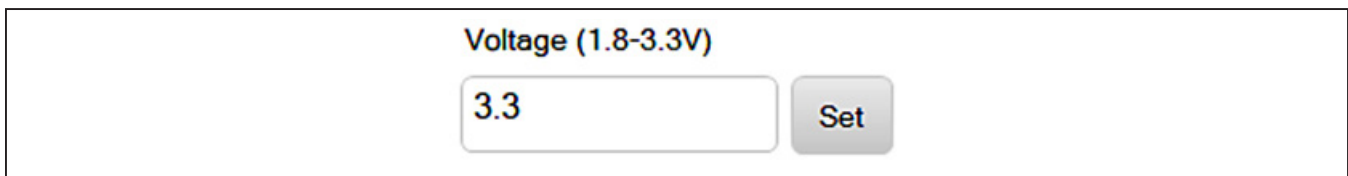

Figure 8. Supply Voltage.

MAX4146x Evaluation Kit

Evaluates: MAX41460
MAX41463
MAX41464

- e. Select the appropriate part in the “Chip” drop-down box and click the <Set> button.
- f. Select the Crystal Frequency (16.0MHz is default) and click the <Set> button.
- g. Select a desired form of modulation in the Modulation drop-down box and click the <Set> button.
- h. Select a PA output power setting (“Power Level 1” is the lowest setting, “Power Level 8” results in the highest output power) and click the <Set> button
- i. Enter the desired operating frequency.
 - i. Enter a value between 250 and 950 (units of MHz) into the Frequency text box; *it is recom-*

- mended that the Frequency be set to match the EV kit tuning (as noted on the hardware).*
- ii. Click the <Set> button.
- j. If running in FSK mode select the “FSKSHAPE” checkbox, set a Frequency Deviation (in \pm kHz), and click the <Set> button.
- k. For 4-wire SPI operation (using the MAX41460, this is needed to read-back register values):
 - i. click on the “0A CFG6” register.
 - ii. click on the “FOURWIRE1” 0-bit box.

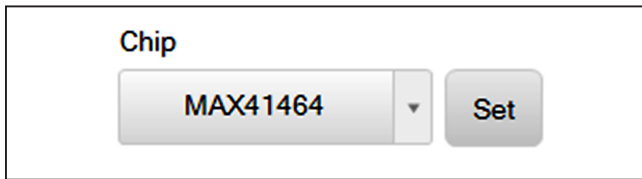

Figure 9. Part Selection

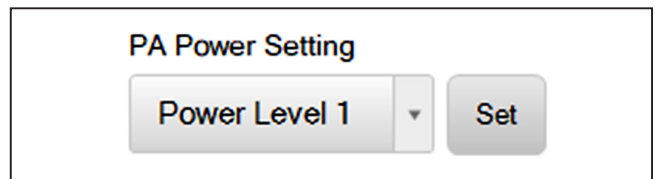

Figure 12. PA Power Setting

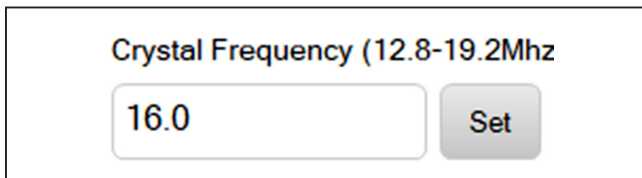

Figure 10. Crystal Frequency Selection

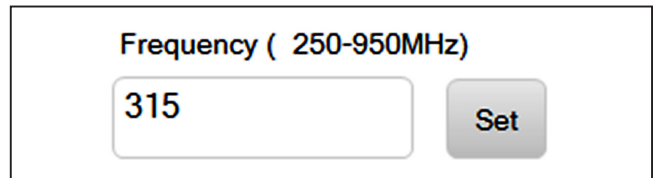

Figure 13. Frequency Setting

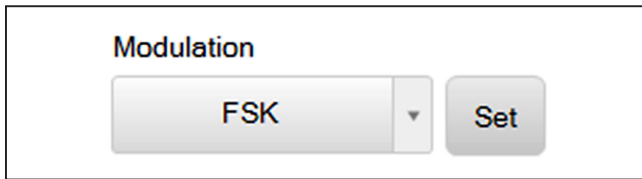

Figure 11. Modulation Selection

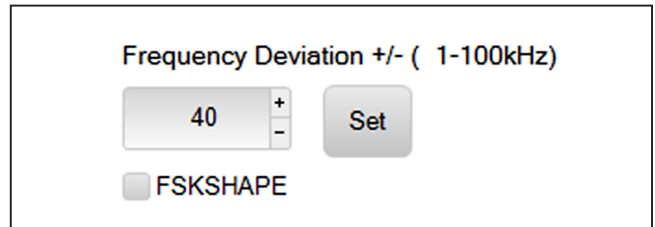

Figure 14. FSK Deviation Setting

Value: 1 Hex Read Register 10 Write Register 10

CFG6 Index: 10d 000Ah

7	6	5	4	3	2	1	0
[4:0]					I2C_TX EN1	SPI_TX EN1	FOURWIRE1
00000b					0b	0b	Bin 1b

Index	Type	Name	Reset	Description
Bit 7:3		0	0x00	-
Bit 2	RW	I2C_TXEN1	0x00	When set, enables DATA transmission in I2C mode Value Enumeration Decode 0x0 DISABLED Data transmission not enabled in I2C mode 0x1 ENABLED Data transmission is enabled in I2C mode
Bit 1	RW	SPI_TXEN1	0x00	Transmission Enable register for SPI mode Value Enumeration Decode 0x0 DISABLED Transmission is disabled in SPI mode 0x1 ENABLED Transmission is enabled in SPI mode
Bit 0	RW	FOURWIRE1	0x00	SPI Four Wire Mode enable Value Enumeration Decode 0x0 DISABLED Four Wire mode is disabled 0x1 ENABLED Four Wire mode is enabled

Find: Bit Fields
 History

Figure 15. 4-Wire SPI Setting.

6. **Generate a transmission**
 - a. In the Data Control block enter a Manchester Bitrate of interest and click the <Set> button.
 - b. Enter 0xAA in the “Messages” text box in the Data Control block.
 - c. Check the “Continuous” checkbox.
 - d. Click on the <Send Data> button, the button will change to <Stop>.
7. **Observe the output on the spectrum analyzer**
8. To manually change the transmitter to a different output power setting.
 - a. Click on the <Stop> button to end the data stream.
 - b. Click on the “06 PA1” register.
 - c. Click on the “PAPWR[2:0]” box and enter the binary value ‘100’.
 - d. Click on the <Send Data> button to restart the transmission.
9. Observe the RF output on the spectrum analyzer.

FTHR Board Quick Start Procedure—Preset Interface

Setup and Connect the MAX41461-MAX4164 EV Kit Hardware to the FTHR Board for a “Data” Signal Source.

1. **Verify all jumpers on the MAX4146x EV kit board are in the default position;** refer to [Table 2](#). *It is recommended the jumpers in [Table 3](#) be set to the output frequency for which the EV Kit is tuned (as noted on the hardware).*
2. **Connect the MAX4146x EV kit to the FTHR Board,** be sure the USB connector is oriented on the opposite side of the SMA connector (see [Figure 3](#)).

3. **Connect the FTHR Board to the PC** using a micro-B USB cable and observe a “heartbeat” on the FTHR board’s red LED.
4. **Connect the RF_OUT to a spectrum analyzer** using a low-loss SMA cable.
 - a. Set the Center Frequency to the target frequency of interest.
 - b. Set the Span to 1% of the Center Frequency, the Resolution Bandwidth (RBW) to 1kHz, and the Video Bandwidth (VBS) to 3kHz.
 - c. Set the trace to “Max Hold”.
5. **Run the MAX4146x EV Kit Control Software GUI**
 - a. Select the appropriate COM port and click on the <Connect> button (see [Figure 6](#)).
 - b. Confirm the firmware status bar has changed from “MAX4146X x.x.x” to “MAX4146X 0.1.0” or similar, the software LED is lit green, and the port status is noted as “Connected” (see [Figure 7](#)).
 - c. Enter a supply level into the “Voltage” text box in units of V and click the <Set> button; for example, enter “3.0” for a 3.0V supply (see [Figure 8](#)).
 - d. Select the appropriate part in the “Chip” drop-down box and click the <Set> button (see [Figure 9](#)).
6. **Generate a data stream.**
 - a. In the Data Control block check the “Preset Mode” checkbox.
 - b. Select the Manchester Bitrate of interest and click the <Set> button.
 - c. Enter 0xAA in the “Messages” text box.
 - d. Check the “Continuous” checkbox.
 - e. Click on the <Send Data> button, the button will change to <Stop>.
7. **Observe the output** on the spectrum analyzer.

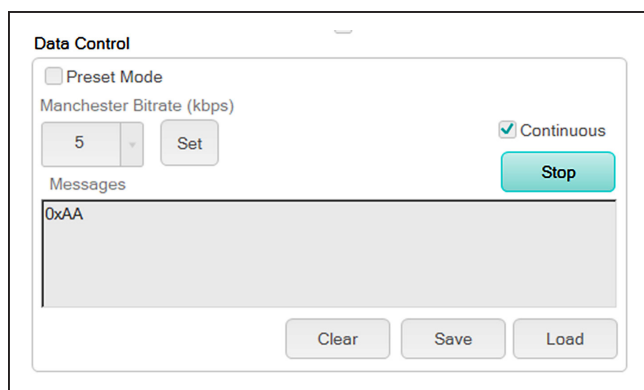

Figure 16. Data Control Block

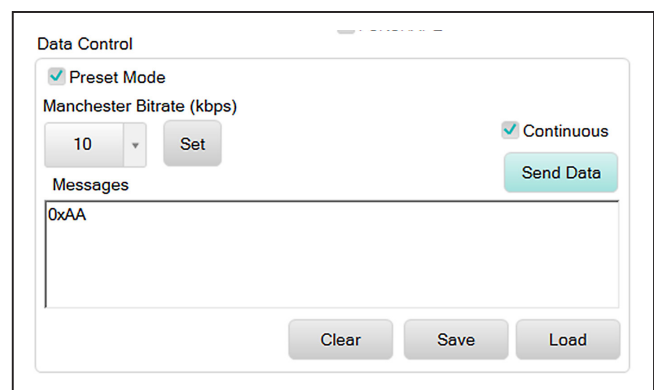

Figure 17. Preset Data

Preset Quick Start Procedure—Without FTHR Board

Setup and Connect the MAX4146x EV Kit Hardware for Stand-Alone Operation

1. **Verify all jumpers on the MAX4146x EV kit board are in the default position**; refer to [Table 3](#). *It is recommended the jumpers from [Table 3](#) be set to the output frequency for which the EV kit is tuned (as noted on the hardware).*
2. **Connect a 3.0V/100mA supply** to the MAX4146x EV kit at the VDD (**Red**) and GND (**Black**) points.
 - a. JU1 setting is not applicable (if the EV kit is still connected to the FTHR board, **JU1 must be “not installed”**).
 - b. **Enable** the power supply’s output.
3. **Connect the RF_OUT to a spectrum analyzer** using a low-loss SMA cable and configure the equipment.
 - a. Set the Center Frequency to the same value as selected with the jumpers in step 1.
 - b. Set the Span to 1% of the Center Frequency, the Resolution Bandwidth (RBW) to 1kHz, and the Video Bandwidth (VBS) to 3kHz.
 - c. Set the trace to “Max Hold”.
4. **Connect a digital data signal to the DATAIN Test Point (Yellow) and GND (Black)**
 - a. Be sure the data levels match the power supply level used in step 2.
 - b. Begin streaming data.
5. **Observe the RF output** on the spectrum analyzer.

Table 3a. MAX41461 EV Kit Preset States, ASK Modulation

SEL1 (JU2)	SEL0 (JU3)	MODE/CENTER FREQUENCY (MHz)
GND	GND	I ² C Interface
GND	Open	315.0*
GND	VDD	318.0
Open	GND	319.51
Open	Open	345.0
Open	VDD	908.0
VDD	GND	915.0
VDD	Open	433.92
VDD	VDD	433.42

Table 3b. MAX41462 EV Kit Preset States, ASK Modulation

SEL1 (JU2)	SEL0 (JU3)	MODE/CENTER FREQUENCY (MHz)
GND	GND	I ² C Interface
GND	Open	315.0
GND	VDD	433.92*
Open	GND	433.0
Open	Open	434.0
Open	VDD	868.3
VDD	GND	868.0
VDD	Open	868.5
VDD	VDD	868.35

Table 3c. MAX41463 EV Kit Preset States, FSK Modulation

SEL1 (JU2)	SEL0 (JU3)	MODE/CENTER FREQUENCY (MHz)
GND	GND	I ² C Interface
GND	Open	315.0
GND	VDD	916.0
Open	GND	908.42
Open	Open	908.8
Open	VDD	908.0
VDD	GND	915.0*
VDD	Open	433.92
VDD	VDD	433.42

Table 3d. MAX41464 EV Kit Preset States, FSK Modulation

SEL1 (JU2)	SEL0 (JU3)	MODE/CENTER FREQUENCY (MHz)
GND	GND	I ² C Interface
GND	Open	315.0
GND	VDD	433.92*
Open	GND	868.42
Open	Open	868.95
Open	VDD	868.30*
VDD	GND	869.85
VDD	Open	868.5
VDD	VDD	868.35

***default position**; the MAX41464EVKIT# is tuned to 433.92MHz, the MAX41464EVKIT-868 is tuned to 868.3MHz.

Table 4. MAX4146x EV Kit Test Points

NAME	COLOR	EVKIT FUNCTION
VDD	Red	1.8V to 3.6V Power Supply pin
GND	Black	Ground
DATIN/SDI	Yellow	TX data or SDI (MAX41460 only) interface
CLKOUT/SDO	Green	Clock output or SDO (MAX41460 only) interface

Detailed Description

Detailed Description of Hardware

MAX4146x EV Kit Printed Circuit Board

The MAX4146x evaluation kit PCB is manufactured on a 2-layer, 1oz copper, FR4 dielectric stack-up PCB. The board was designed to accommodate all five versions of the ISM transmitter: MAX41460, MAX41461, MAX41462, MAX41463, and MAX41464. Layer 1 is primarily designed to keep the RF signals on one side of the board with short traces, small matching components, and low parasitics. Layer 2 was targeted to be a continuous ground plane wherever possible.

Control Interface

There are three forms of interfacing to the MAX4146X device depending on the part installed: 3 or 4-wire SPI, “preset” or pin-configured, and the special case of an I²C control interface. The MAX41460 device will require a 3- or 4-wire SPI connection and the MAX4146x EV kit was designed to use the provided FTHR board interface

through the H1/H2 headers. Other MCU connections can be made through the JU4 PMOD header (see the [Pmod Interface](#) section).

Power

The MAX4146x EV kit board can be powered directly from the FTHR board PMIC through the H1 header, directly from the supply test points, or through the user-installed Pmod header. A single +1.8V to +3.6V, 100mA power supply can be connected to the board using the two wire loops (marked VDD and GND). Jumper JU1 selects the source of power when not using the direct connection test points: from the L3OUT of the FTHR board or the PVIO of the Pmod connector.

Data Interface

The MAX4146x EV kit comes preconfigured to directly connect the FTHR board through the H1/H2 headers to the SPI and the I²C interfaces. The GUI will determine which bus is used to communicate to the device based on the “Chip” selected in the software.

MAX4146x ASK/FSK TRANSMITTER EV KIT

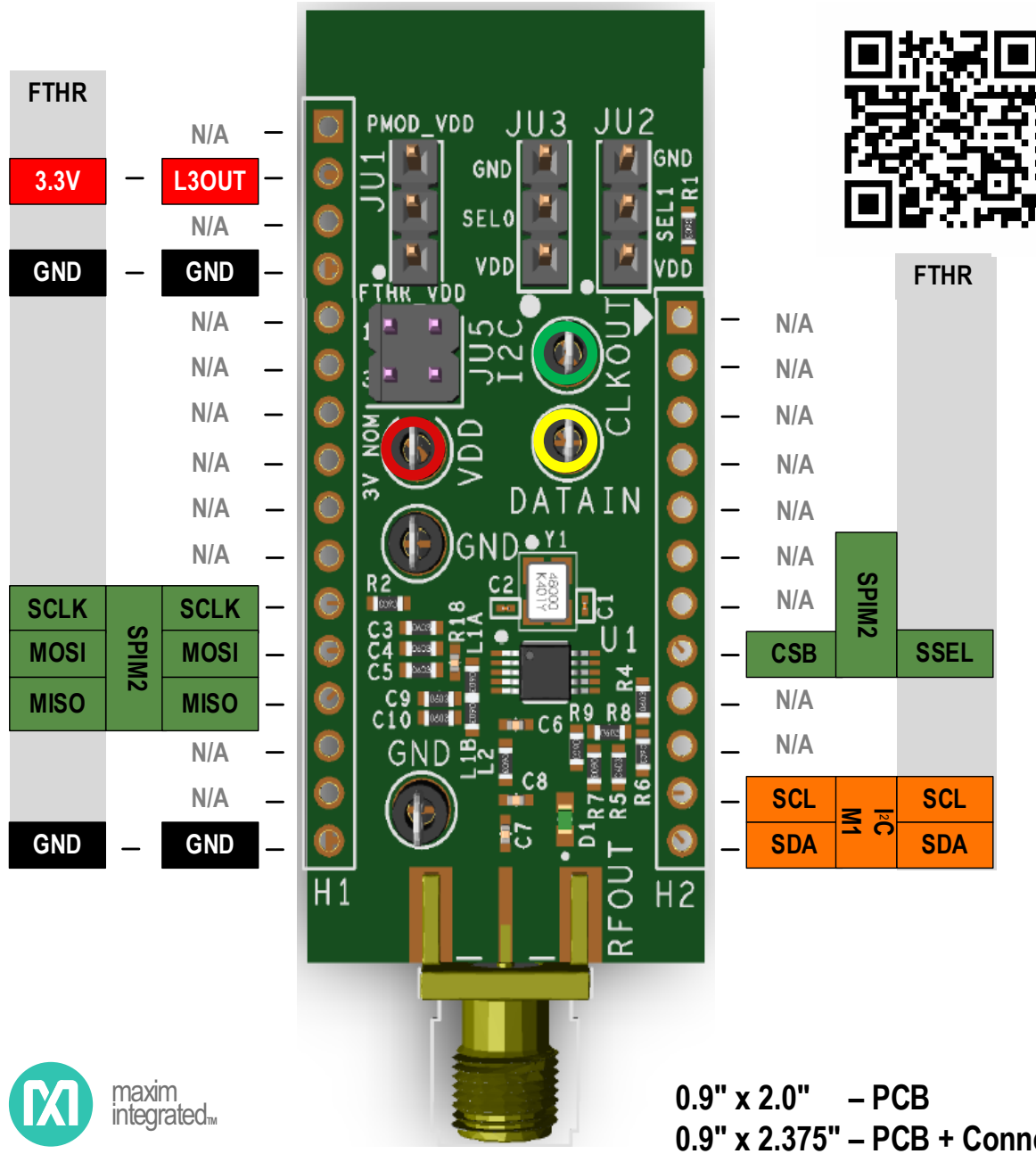

Figure 18. MAX4146X EV Kit Interface

Clock Output

When sending data to a MAX41461–MAX41464 in preset mode the CLKOUT pin will drive an 800kHz clock signal. This clock output signal can be monitored with the **Green** CLKOUT test point. Note the output from the MAX41461–MAX41464 is not designed to drive a high capacitive load and may cause noticeable $\pm 800\text{kHz}$ spurs in the spectrum when the CLKOUT test point is connected to a capacitive load of more than 10pF. A typical, low-end oscilloscope probe may be enough to cause these spurs.

I²C Pullups

Resistors R14 and R15 along with jumper JU5 have been provided as on-board pull-ups required for proper I²C interfacing and termination. When using a MAX41461–MAX41464 device in preset mode, the DATAIN line should be held low at power-up for proper configuration, therefore, the R16, 100k Ω is the default connection. When used in I²C mode, the DATAIN pin is used instead as the I²C, SDA line. Likewise, the CLKOUT pin is used as the I²C SCL input. These pins are open-collector (or open-drain) outputs from a the MCU and need to have pullup resistors to operate properly. Two 4.7k Ω resistors are pre-populated on the MAX4146x EV kit and can be connected to the positive supply by shorting the JU5 jumper 1-2 and 3-4. This should only be connected when the preset pins (SEL0 and SEL1) are both connected to ground, selecting the I²C interface mode of the MAX4146x. It should be noted that the FTTH board also has footprints for I²C pullup

resistors at R6 and R11. Both sets of pullup resistors (on the FTTH board and the MAX4146x EV kit) should not be populated simultaneously, otherwise incorrect I²C signal levels may result. Refer to [Appendix II](#) for detailed information on evaluation kit hardware modifications.

Data Indicator

An option available on the evaluation kit layout is the ability to connect a surface-mount LED (D1, 0603) and resistor (R9, 0603, 470 Ω recommended) to provide visual feedback of the activity on the DATAIN line. Populating this LED and resistor will cause additional power consumption and is not included by default in the evaluation kit assembly.

Pmod Interface

The MAX4146x EV kit provides a Pmod-compatible header footprint to interface with the transmitter. The JU4 connector can be populated with a 6-pin, 100mil, right-angle header allowing direct connections to the CSB, DATAIN, CLKOUT, SCLK/SDA, ground, and VDD lines, making it capable with either SPI or I²C Pmod interfacing. Populating this header would allow control from the MAX32600MBED kit and the MAXREFDES72# Arduino Uno R3 to Pmod shield adaptor. When using the Pmod interface to supply the MAX4146x EV kit with power, make sure to connect the JU1 jumper between pins 2-3. Refer to [Appendix II – Hardware Modifications](#) for detailed information on evaluation kit hardware modifications.

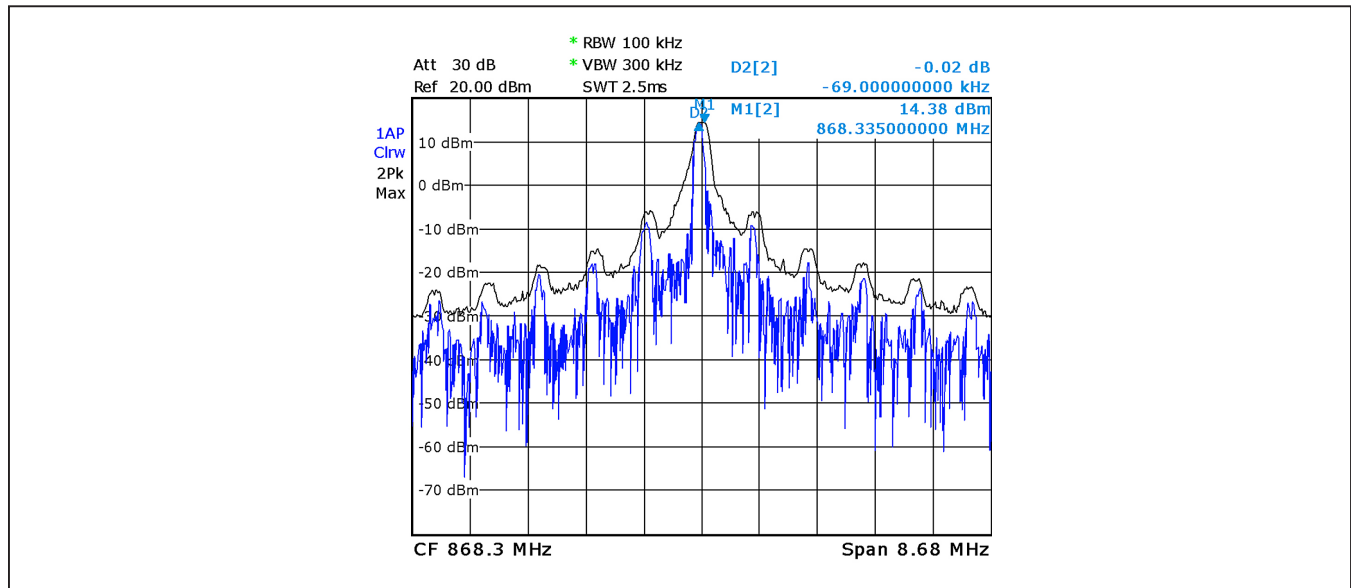

Figure 19. 800kHz Spurs from Excessive CLKOUT Loading

MAX4146x Evaluation Kit

Evaluates: MAX41460
MAX41463
MAX41464

Detailed Description of Software

The MAX4146x EV kit Controller GUI Software is designed to control the MAX4146x evaluation kit board and the MAX32630FTHR board as shown in [Figure 3](#). The software includes USB controls which provide SPI, I²C, or data-only communication to the MAX4146X through the FTHR board interface.

Comport

The COM Port section provides a drop-down selection of serial communication ports available for connection to a MAX4146X evaluation kit through a FTHR board. When the GUI is run after connecting the evaluation kit hardware, the drop-down box should default to the proper COM Port. If the hardware is connected to the computer after the GUI is started, click on the <Refresh> button to scan for compatible ports. Once the appropriate COM Port is selected in the drop-down box, click on the <Connect> button. (See [Figure 6](#))

After properly connecting to the COM Port with the FTHR board, the GUI will display the revision of FTHR board firmware detected, display a Green “LED”, and display “Connected” in the status bar along the bottom of the GUI window. ([Figure 7](#))

Voltage (1.8–3.3V)

The Voltage section provides a user-adjustable power supply from the FTHR board MAX14690N Power Management IC (PMIC) to the **MAX4146x EV kit** and can be used as the primary VDD supply. The PMIC, L3OUT can be set to voltages between 1.8V to 3.3V and it applies

to the level of the logic interface lines as well as the device supply. ([Figure 8](#))

To program the supply voltage, enter a valid level in the “Voltage” text box and click on the <Set> button. The default value of the L3OUT voltage is 3.3V.

When using the FTHR board interface to supply the **MAX4146x EV kit** with power, make sure to connect the JU1 jumper between pins 1-2.

Chip

The Chip section must be set by the user to properly select which type of **MAX4146x EV kit** is attached to the FTHR board. This selection will configure the GUI software to interface through the SPI pins (when MAX41460 is selected), through the I²C pins, or provide a simple data stream to the device (when the MAX41461, MAX41462, MAX41463, or MAX41464 are selected).

To select the part, chose the appropriate part in the “Chip” drop-down box and click on the <Set> button. ([Figure 9](#))

Crystal Frequency (12.8MHz–19.2MHz)

The Crystal Frequency section allows the user to indicate the frequency of the crystal installed on the **MAX4146x EV kit** (f_{XTAL}). All evaluation kits come prepopulated with a 16.000MHz crystal and the default setting in the GUI is assumed to be 16.0MHz. This value can be adjusted between 12.8MHz and 19.2MHz and will be used when programming frequency-basted registers that are dependent on the f_{XTAL} value.

To configure the reference oscillator, enter a valid frequency (in MHz) in the “Crystal Frequency” text box and click on the <Set> button. ([Figure 10](#))

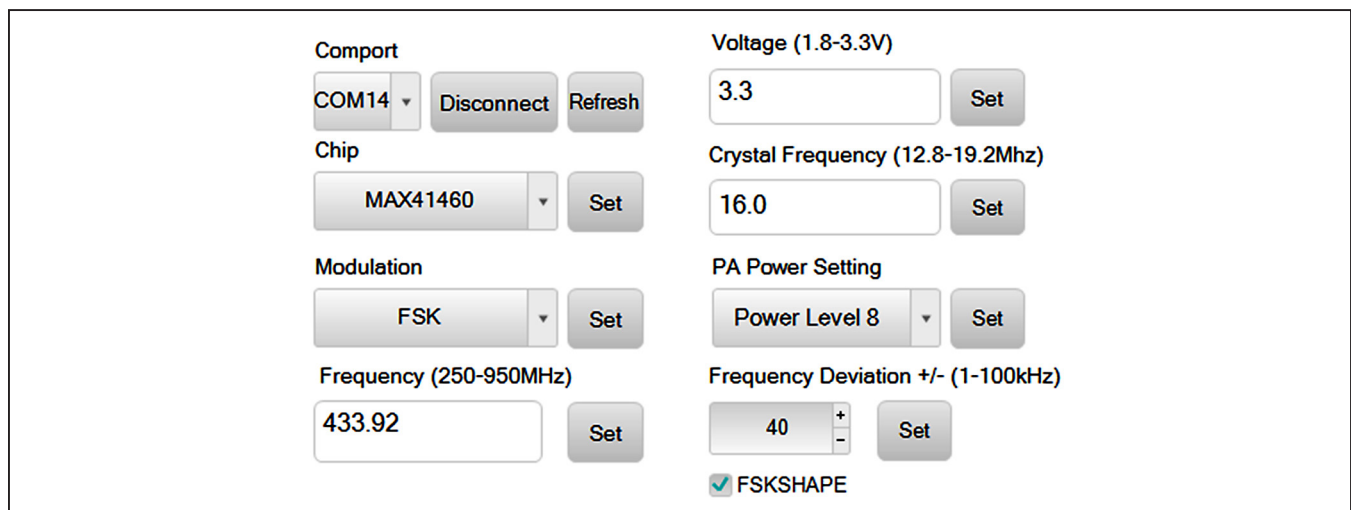

Figure 20. MAX4146x EV Kit GUI Configuration

Modulation

The Modulation section allows the user to quickly set the form of modulation for the MAX4146x device. When a MAX41461 or MAX41462 device is selected, only ASK modulation will be available in the drop-down box. Similarly, when MAX41463 and MAX41464 is selected, only FSK will be available in the drop-down box. This section directly programs the MODMODE bit [0] in the CFG1 register (0x00).

To select the modulation, chose ASK or FSK in the “Modulation” drop-down box and click on the <Set> button. (Figure 11)

PA Power Setting

The PA Power Setting section allows the user to quickly set the power level of the PA. This section directly programs the PAPWR bits [2:0] in the PA1 register (0x06). The maximum output power is obtained by selecting “Power Level 8” or 111b in the register. The default minimum output power for the MAX4146x when interfacing through I2C and SPI is “Power Level 1” or 000b in the register. Each bit can adjust the PA output by approximately 2.5dB.

To select the output power level, choose the appropriate “Power Level” in the “PA Power Setting” drop-down box and click on the <Set> button. (Figure 12)

The power level can also be set manually through the [Direct Register Access](#) Section by clicking on the 06 PA1 (0x06) register, clicking on the PAPWR[2:0] field, and typing in a binary value between 000b and 111b.

Frequency

The Frequency section is used to set the carrier or “center” frequency of the MAX4146x (f_C or f_{LO}). The value entered in this section will be used to calculate the 3-word Fractional-N value programmed into the PLL3 (0x0B), PLL4 (0x0C), and PLL5 (0x0D) registers. The GUI will calculate the values for the PLL registers using the Crystal Frequency and the following formula:

Equation 1:

$$FREQ [23 : 0] = Round \left(\frac{65536 \times f_C}{f_{XTAL}} \right)$$

To program the carrier, enter a valid frequency (in MHz) into the “Frequency” text box and click on the <Set> button. (Figure 13)

Frequency Deviation

The Frequency Deviation section is used to set the FSK deviation values (Δf) and the Gaussian shaping bit. The value entered in this section is used to calculate the 7-bit content for the PLL6 (0x0E) register. This calculation will also use the value entered for the [Crystal Frequency](#) section. The formula for setting the register value is:

Equation 2:

$$DELTA AF [6 : 0] = Floor \left(\Delta f \times \frac{8192}{f_{XTAL}} \right)$$

To program the Δf, enter a valid frequency (in kHz) into the “Frequency Deviation” text box and click on the <Set> button. (Figure 14)

The GUI software will adjust the carrier frequency based on ½ of this Δf value to maintain the center of the FSK signal. This will place f_{SPACE} at f_C – Δf/2 and f_{MARK} at f_C + Δf/2. If the center frequency is adjusted and programmed after setting the Frequency Deviation, then f_{SPACE} = f_C and f_{MARK} = f_C + Δf. To reset the center of the FSK signal to f_C, simply click on the Frequency Deviation <Set> button again.

Data Control Section

This portion of the GUI software provides a flexible tool for the user to generate data for SPI, I2C, or the preset parts, all from a single interface.

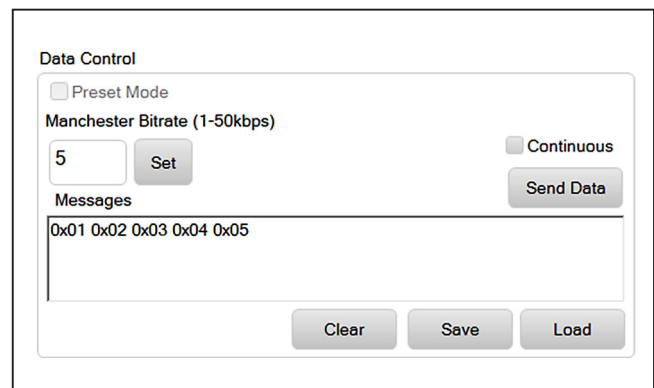

Figure 21. Preset Data

Preset Mode

When using a MAX41461-64 evaluation kit in preset mode, the GUI can provide simple Manchester encoded data directly to the DATAIN pin of a connected device. Simply select the <Preset Mode> checkbox to generate this data without any other interfacing. All the following settings are then used to format a data stream to send directly to the DATAIN pin on the attached MAX4146x EV kit.

Manchester Bitrate

This is the data rate in kbps for Manchester encoded data. Enter a value in the text box and click the <Set> button to configure the Data Control.

When communicating with a MAX41461–MAX41464 in I²C mode, this bitrate value will be used to program the Baud Clock values BCLK_POSTDIV[2:0] in the CFG2 (0x01) register and the BCLK_REDIV[7:0] in the CFG3 (0x02) register. According to the formula:

Equation 3:

$$BAUDRATE = \frac{f_{CLK}}{(1 + BCLKPREDIV) \times 2^{(1+BCLKPOSTDIV)}}$$

Equation 4:

Where: $f_{CLK} = \frac{f_{XTAL}}{XODIV \text{ Ratio}}$

with default settings of : $f_{CLK} = \frac{16MHz}{5} = 3.2MHz,$

BCLKPOSTDIV = 1 to 5, and BCLKPREDIV = 3 to 255

Using the following equation and the default crystal frequency, the BCLK_PREDIV can be calculated from the target baud rate using ranges set by BCLK_POSTDIV:

Equation 5:

$$BCLKPREDIV = \frac{3.2MHz}{BAUDRATE \times 2^{(1+BCLKPOSTDIV)}} - 1$$

Equation 5a:

$$BCLKPREDIV = \frac{800kHz}{BAUDRATE} - 1,$$

when BCLK_POSTDIV = 1

Equation 5b:

$$BCLKPREDIV = \frac{400kHz}{BAUDRATE} - 1,$$

when BCLK_POSTDIV = 2
etc...

When using devices in I²C mode, this baud rate must not exceed the rate at which data is being written to the TX Data FIFO. Otherwise, the buffer will be emptied (under-flow) with the first packet transfer and the MAX41461-MAX41464 will exit transmission mode. Generally, that baud rate is 8/9 of the SCL rate, which for the FTMR board interface $f_{SCL} = 400kHz$. Therefore, the maximum baud rate of 200kbaud is obtainable using the evaluation kit setup in I²C mode.

Continuous Transmission

Selecting this check box will configure the Data Control interface so the message or data sequence will repeat until the user interrupts the transmission. For example: when a “0xAA” message is sent with <Continuous> unchecked, the sequence of 1-0-1-0-1-0-1-0 bits will be transmitted a single time. When the <Continuous> is checked, the <Send Data> process will continuously send a repeating sequence of 1-0-1-0-1-0-1-0-1-0-1-0-1-0-1-0-1-0... bits, emulating a square wave data pattern.

Table 5. Baud Rate Programming

BCLK_POSTDIV	MIN BAUD (BCLK_PREDIV = 255)	MAX BAUD (BCLK_PREDIV = 3)	BCLK_PREDIV RESOLUTION
1	3125Hz	200kHz	~12Hz to 40kHz
2	1562.5Hz	100kHz	~6Hz to 20kHz
3	~781.3Hz	50kHz	~3Hz to 10kHz
4	~390.6Hz	25kHz	~1.5Hz to 5kHz
5	~195.3Hz	12.5kHz	~0.8Hz to 2.5kHz

Messages Text Block and Message File

The <Messages> text block contains a hexadecimal encoded data string to be transmitted with the FTTH board over the data interface. This message is formatted differently depending on the “Chip” selected and the mode of operation. For example, when in preset mode the data is streamed directly to the DATAIN pin of the MAX4146x evaluation kit. When in I²C mode, the message is packetized and formatted across the I²C registers for transmission at the baud rate set with the “Manchester Bitrate” control noted previously. Finally, when used with a MAX41460 SPI device, the CSB and DATA pins are used to transmit the message at the bitrate noted previously.

Tools are provided to allow the user to quickly load complex test packets generated outside of the GUI. The <Clear>, <Save>, and <Load> buttons help control the contents of the <Messages> text block.

By clicking on the <Clear> button, any contents in the <Messages> text block will be deleted.

Clicking the <Save> button will store the contents of the <Messages> block to a file. A “Save As” explorer window will open, and the user will be prompted to save a .txt file.

Clicking the <Load> button will pop-up an “Open” window and prompt the user for a .txt file to load into the <Messages> text block.

Tool History Section

This portion of the GUI contains a Log File text block which is used to record activity within the GUI.

Log File

For every <Set>, connection effort, or register programming action, the GUI activity is logged in this text block. The user can add notes and make edits to the content of the Log File text block.

Clicking on the <Clear Log File> will delete the contents in the text block.

Clicking the <Save Log File> button will open a “Save As” explorer window and the user will be prompted to save a .txt file.

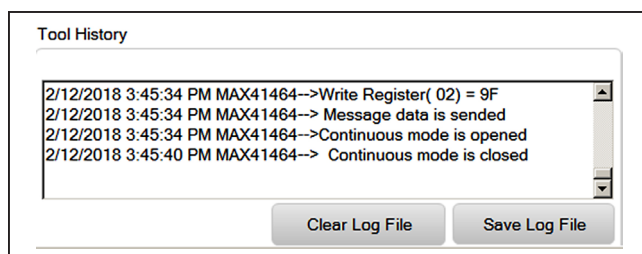

Figure 22. Tool History

Direct Register Access Section

The GUI software allows for direct access to all the available register when interfacing with both the MAX41460 SPI-based device or the MAX41461-64 devices in I²C mode.

Register List

On the left-hand side of the *Register Interface* section is a list of the device’s internal registers. Each register address/name (e.g., “00 CFG1”) acts as an active control and by clicking on an individual register, the contents will be presented in the *Register Value* section.

Register Value

The right-hand side of the *Register Interface* section displays the content of the selected device register. At the top of the block, a header displays the name of the selected register (e.g., “CFG1”), the “Index” or address of the register in both decimal (“0d”) and hexadecimal (“0000h”) form.

The body of this section shows a table with the names of the individual bits for the selected 8b register along with the current value programmed into each bit or bit group.

The remaining portion of the body shows a table with the bit indexes, the type of register (write/read), the name of the bit or bit group, the Reset value, and a description of the bit or bit group.

Read and Write Registers

Most of the registers in the MAX4146x are both readable and writable. The read-only registers are I2C4 (0x14), I2C5 (0x15), I2C6 (0x16), ID1 (0x1B), ID2 (0x1C), and STATUS (0x1D). Writing values to a register can be accomplished by selecting the register of interest, typing a Hex or Dec value into the “Value” text box, and clicking on the <Write Register X> button (where X is the decimal address of the register). Reading the register content is similar: select the register of interest and click on the <Read Register X> button.

Register Bit Field

Individual bits or bit groups can be programmed without having to enter the full value of the register. To program a bit or group of bits, first select the register of interest (PA1, 0x06 for example), next select the bit or bit group to be changed (PAPWR[2:0] as an example), enter the binary code for the new value (111b), and hit <Enter>--the new value will automatically be reflected in the “Value” text box and will be written to the device.

Miscellaneous Software Information

The tool bar along the top of the GUI software provides a couple of options to the user.

File and Help Menu

Selecting File > Exit from the tool bar will close the GUI program. This has the same effect as clicking the <X> button in the upper-right corner of the GUI software.

Selecting Help > About from the tool bar will display the splash screen. This window shows the name of the software, the revision number, a copyright notice, a link to the Maxim website, a link to the support website, and a checkbox to enable or disable the splash screen during startup. Click the <OK> button to close the About window.

.xml File

The register descriptions for the MAX4146X GUI is available in an .xml file which is stored with the executable in the application directory. The default file loaded when the GUI is initialized is `RegisterSet8.XML`. This file can be edited as needed to adjust the names of fields, provide simple indicators to the GUI user, or allow for flexible updates to the GUI interface in the future.

Use Cases

Three Interface Modes for Data Transmission and Control

The MAX4146x family of parts allow a great deal of flexibility when it comes to transmitting data. Typically, the fewer pins used to interface with the device, the simpler it is to control and transmit data.

Preset Mode

Preset mode is the simplest interface of the three options. It relies on the part number to choose the modulation (MAX41461 and MAX41462 for ASK; MAX41463 and MAX41464 for FSK) and jumper settings (or tri-level pin connections) to configure the part for a defined carrier frequency (See [Table 3](#)).

The preset mode data interface requires only one pin to transmit data, wake-up, and shut-down the transmitter. To accomplish this the MAX4146x uses an auto-data-detection process on the DATAIN connection to determine when to power-up and transmit and when to shut down.

The baud rate and encoding of the transmission data is defined by the user simply by creating a virtual connection between DATAIN and the PA (DATAIN H/L = on/off for ASK modulation or mark/space for FSK modulation). Input to DATAIN is interpreted as an NRZ data sequence and if a particular encoding format is required (pulse width, Manchester, etc) the input

sequence can be directly encoded by the MCU onto DATAIN—what goes in is what comes out.

I²C Mode

The I²C interface mode allows the user to access the internal registers of the MAX41461-64 devices, permitting full control over the transmission frequency, modulation setting, programmable output power, sophisticated low-power and low-noise operational settings, etc.

This mode only requires two digital pins to interface with the transmitter but has a more complicated, packet-based method of transmission. Once configured for I²C interfacing, the DATAIN connection is used as the SDA line of the I²C bus. Data transmission is handled by sending data packets to the internal FIFO over the I²C interface. The FIFO data are then transmitted at the pre-programmed baud rate and the transmission is halted when either of two conditions are met: 1) the PKTLEN value has been reached, or 2) a FIFO underflow (or overflow) occurs. The register-programmed baud rate defines the frequency at which NRZ data are transmitted. If other data encoding formats are required (pulse width, Manchester, etc), either the I²C data packet can be formatted to emulate the encoding or the other modes of operation (Preset or SPI Mode) should be used.

All the MAX41461-MAX41464 devices are identified with an I²C address of 0xD2 for write and 0xD3 for read sequences. Packet transmission is described in the various device data sheets within the “*Two-Wire I²C Serial Interface*” section.

SPI Mode

The SPI interface is only available on the MAX41460 device. Similar to the I²C mode devices, the SPI interface allows access to the internal registers of the transmitter. This permits the user to have full control over the same properties of transmission frequency, modulation setting, programmable output power, sophisticated low-power and low-noise operational settings, etc.

This mode allows for either a 3-wire interface (write-only) or a 4-wire read/write interface. Data transmission is handled with a three-step process: 1) transition the CSB line low; 2) perform any register configurations then switch to transmit mode by setting the SPI_TXEN1 bit in the CFG6 (0x0A) register or the SPI_TXEN2 bit in the CFG7 (0x0B) register; 3) hold the CSB line low and sequence the DATAIN line just like in preset mode operation. Taking the CSB line high will end transmission and cause the MAX41460 to enter shut down or standby mode (determined by register settings).

MAX4146x Evaluation Kit

Evaluates: MAX41460
MAX41463
MAX41464

The baud rate and encoding of the transmission data is defined by the user simply by creating a virtual connection between DATAIN and the PA (DATAIN H/L = on/off for ASK modulation or mark/space for FSK modulation). Input to DATAIN is interpreted as an NRZ data sequence and, if a particular encoding format is required (pulse width, Manchester, etc.), the input sequence can be directly encoded by the MCU onto DATAIN—what goes in is what comes out.

A full description of the SPI interface can be found in the “*Serial Peripheral Interface (SPI)*” section of the MAX41460 device data sheets.

Clock Output

The CLKOUT pin on the MAX4146x devices is available for synchronous interfacing to an MCU in the transmitter application.

When MAX41461-MAX41464 devices are used in preset mode, the CLKOUT pin provides an 800kHz square wave output signal when the device is active. If these parts are used in I²C mode, the CLKOUT pin is repurposed as the SCL pin and there will no longer be an output clock signal.

When a MAX41460 device is configured for a 3-wire SPI interface, the CLKOUT pin will provide an 800kHz square wave output signal when the device is active. If the MAX41460 is configured for a 4-wire SPI interface, the CLKOUT pin is repurposed as the SDO or MISO pin. There will not be an output clock signal but rather the read-sequence serial data output.

As noted in the [Detailed Description of Hardware](#) section, the CLKOUT pin is not designed to drive a high capacitive load and may cause noticeable $\pm 800\text{kHz}$ spurs in the transmission spectrum when it is connected to a capacitive load of more than 10pF.

High Power “Boost” Mode

Boost mode in the MAX4146x is accessible whenever the user is interfacing with the transmitter’s registers through I²C or SPI. Use of the boost mode is not recommended on unmodified evaluation kit when operating at frequencies below 850MHz because the larger voltage swings imposed on the PA output may exceed the Absolute Maximum ratings of the device.

Setting the boost mode in the MAX4146x changes the “on” duty cycle of the PA output stage FETs from 25% of

the programmed transmission frequency to 50%. To make this change, select the SHDN (0x05) register and set the PA_BOOST bit to 1b.

Higher output power can also be accomplished with adjustments to the output matching network. See [Appendix II – Hardware Modifications](#) for more details.

For additional information on switch-mode PAs similar to the one used in this transmitter, see *Application Note 3589—Power Amplifier Theory for High-Efficiency Low-Cost ISM-Band Transmitters*. Refer to [Appendix II – Hardware Modifications](#) for detailed information on hardware modifications.

Shutdown, Standby, and Program Modes

When communicating with a MAX41460 device or the MAX41461-64 device in I²C mode, the part can be programmed to power-down into one of three low-current, non-transmitting states after completing a transmission: shutdown, standby, and program mode.

Shutdown is the lowest-current power-down state and is the default condition for all devices, including parts used in preset mode. Standby allows the transmitter to startup quicker than shutdown by keeping the crystal oscillator circuit running. Finally, programming mode keeps both the crystal oscillator and the PLL running allowing for the quickest transition from programming to full transmission.

To set the power-down mode, click on the CFG4 (0x03) register, select the PWDN_MODE[1:0] and enter a value of 01b for standby mode. The program mode value is 10b and the default value for shutdown mode is 00b.

Variable Capacitance

As noted in the data sheet, the PA output has an inherent capacitance (approximately 4.7pF). The MAX4146x family of transmitters have a 5-bit programmable capacitance value which can help the user ‘tune’ the output network by varying the PA capacitance. Each step of the programmable capacitance has a nominal resolution of 0.18pF ranging from a total of 4.7pF to about 10pF.

To program this value click on the PA2 (0x07) register, select the PACAP[4:0] bit group, and enter a value for the adjustable capacitance such as 1000b. The default value is no added capacitance: 00000b.

PLL Control

The MAX4146x transmitter has two modes of operation for the PLL: low-current and low phase noise mode. Low current mode uses an internal ring oscillator VCO which has advantages in power consumption and tunability, allowing for continuous tuning from 286MHz to over 960MHz. The low phase noise mode switches the PLL over to an LC VCO providing a more controlled, higher-Q reference with the limitation of fixed operating bands of 286MHz~320MHz, 425MHz~480MHz, and 860MHz~960MHz (defined by the N-divider).

To switch from the default ring-oscillator VCO to the LC VCO, click on the PLL1 (0x08) register, select the LOMODE bit, and enter the value of 1b. Next, select the LODIV[1:0] bit group and program the divider ratio based on the targeted operating frequency.

When switching back to the ring-oscillator VCO, be sure to set the LOMODE bit back to 0b and the LODIV[1:0] bit group back to 00b.

Chip ID

Register ID1 (0x1B) provides a readable identification number for the device. When communicating with a MAX41460 device, the ID value will be reported as 0x6F. When communicating with a MAX41461–MAX41464 device in I²C mode, the ID value will be reported as 0x60.

The ID2 register (0x1C) provides a readable revision number for the device. The default value for this register is 0x0A. This register can easily be used as a confirmation of proper I²C and 4-wire SPI communication simply by reading-back the value of the ID2 register to confirm the result as “0x0A”.

Table 6. VCO Divider Settings

VCO	LO MODE SETTING	FREQUENCY RANGE (MHz)	LODIV[1:0] SETTING
Ring Oscillator*	0b	286~960MHz	00b
LC VCO	1b	286~320	11b
LC VCO	1b	425~480	10b
LC VCO	1b	860~960	01b

*Default

Ordering Information

PART	TYPE
MAX41460EVKIT#	SPI Interface at 434MHz
MAX41464EVKIT-868	Preset/I ² C
MAX41464EVKIT#	Preset/I ² C at 434MHz
MAX32630FTHR#	ARM mBed FTHR Platform

RoHS-compliant device.

MAX4146x Evaluation Kit

Evaluates: MAX41460
MAX41463
MAX41464

MAX4146x EV Kit Component List

PART	QTY	DESCRIPTION
C1, C2	2	5pF ± 0.25pF Capacitor (01005) muRata GRM0225C1H5R0CA03
C3	1	0.47µF ± 10% Capacitor (0603) muRata GRM188R71C474K
C4	1	0.01µF ± 5% Capacitor (0603) muRata GRM1885C1H103JA01
C5	1	220pF ± 5% Capacitor (0603) muRata GRM1885C1H221JA01
C6	1	3.3pF ± 0.25% Capacitor (0402) muRata GRM1555C1H3R3BA01D
C7	1	100pF ± 5% Capacitor (0402) muRata GRM1555C1H101JA01
C8	1	4.7pF ± 0.1% Capacitor (0402) muRata GJM1555C1H4R7BB01
C9, C10	1	DNP
CLKOUT	1	Test Point Keystone 5126
D1	1	DNP
DATAIN	1	Test Point Keystone 5014
GND, GND1	2	Test Point Keystone 5011
H1	1	Connector Male Through Hole Sullins PRPC016SFAN-RC
H2	1	Connector Male Through Hole Sullins PRPC012SFAN-RC
JU1-JU3, JU5	3	Connectors Male Through Hole Sullins PEC03SAAN / PEC02SAAN

PART	QTY	DESCRIPTION
JU4	1	DNP
L1A	1	5.6nH ± 5% Inductor (0603) muRata LQW18AS5N6J0Z
L1B	1	DNP
L2	1	18nH ± 5% Inductor (0603) muRata LQW18AN18NJ80
R1-R5	5	DNP (MAX41464)
R6-R8	3	0Ω ± 0% Resistor (0603) Vishay Dale CRCW06030000Z0
R9-R13, R17-R18	7	DNP
R14, R15	2	4.7kΩ ± 5% Resistor (0603) Panasonic ERJ-3GEYJ472V
R16	1	100kΩ ± 1% Resistor (0603) Panasonic ERJ-3EKF1003
RFOUT	1	SMA Connector Johnson Components 142-0701-851
SU1-SU3, SU5	4	Test Point Jumpers Sullins STC02SYAN
U1	1	MAX41464GUB+ TSSOP10
VDD	1	Test Point Keystone 5013
Y1	1	16 MHz Crystal Epson TSX-3225 16.0000MF18X-AC0

Component Suppliers

SUPPLIER	WEBSITE
Epson America	www5.epsondevice.com
Johnson Components/Cinch	belfuse.com/cinch
Keystone	www.keyelco.com
Murata Electronics North America, Inc.	www.murata.com
Panasonic	
Sullins	www.sullinscorp.com
Vishay Dale	www.vishay.com

Note: Indicate that you are using the MAX4146x when contacting these component suppliers.

MAX4146x Evaluation Kit

Evaluates: MAX41460
MAX41463
MAX41464

MAX4146x EV Kit Bill of Materials

ITEM	REF_DES	DW/DNP	QTY	MFG PART #	MANUFACTURER	VALUE	DESCRIPTION	
1	C1, C2	—	2	GRM0225C1H5R0CA03	MURATA	5PF	CAP, SMT (01005); 5PF; ±0.25PF; 50V; COG; CERAMIC CHIP;	
2	C3	—	1	C0603C474K4RAC; GRM188R71C474K	KEMET;MURATA	0.47UF	CAPACITOR; SMT; 0603; CERAMIC; 0.47uF; 16V; 10%; X7R; -55°C to + 125°C; 0 ±15%/°C MAX.	
3	C4	—	1	C1608C0G1H103J; CGA3E2C0G1H103J080AD; GRM188SC1H103JA01	TDK;TDK;MURATA	0.01UF	CAPACITOR; SMT (0603); CERAMIC CHIP; 0.01UF; 50V; TOL = 5%; TG = -55°C to +125°C; TC = COG	
4	C5	—	1	GRM188SC1H221JA01	MURATA	220PF	CAPACITOR; SMT (0603); CERAMIC CHIP; 220PF; 50V; TOL = 5%; TG = -55°C TO +125°C; TC = COG	
5	C6	—	1	GRM1555C1H3R3BA01	MURATA	3.3PF	CAP, SMT (0402); 3.3PF; ±0.1PF; 50V; COG; CERAMIC CHIP	
6	C7	—	1	C0402C101J5GAC; NMC0402NPO101J; CC0402JRNPO98N101; GRM1555C1H101JA01; C1005C0G1H101J050; CGA2B2C0G1H101J050BA	KEMET;NIC COMPONENTS CORP.; YAGEO PHICOMP;MURATA;TDK;TDK	100PF	CAPACITOR; SMT (0402); CERAMIC CHIP; 100PF; 50V; TOL = 5%; TG = -55°C TO +125°C; TC = COG	
7	C8	—	1	GJM1555C1H4R7B001	MURATA	4.7PF	CAPACITOR; SMT (0402); CERAMIC CHIP; 4.7PF; 50V; TOL = 0.1PF; TG = -55°C TO +125°C; TC = COG	
8	CLKOUT	—	1	5126	KEYSTONE	N/A	TEST POINT; PIN DIA = 0.125IN; TOTAL LENGTH = 0.445IN; BOARD HOLE = 0.063IN; GREEN; PHOSPHOR BRONZE WIRE SILVER PLATE FINISH;	
9	DATAIN	—	1	5014	KEYSTONE	N/A	TEST POINT; PIN DIA = 0.125IN; TOTAL LENGTH = 0.445IN; BOARD HOLE = 0.063IN; YELLOW; PHOSPHOR BRONZE WIRE SILVER PLATE FINISH;	
10	GND, GND1	—	2	5011	KEYSTONE	N/A	TEST POINT; PIN DIA = 0.125IN; TOTAL LENGTH = 0.445IN; BOARD HOLE = 0.063IN; BLACK; PHOSPHOR BRONZE WIRE SILVER PLATE FINISH;	
11	H1	—	1	PRPC016SFAN-RC	SULLINS ELECTRONICS CORP	PRPC016SFAN-RC	CONNECTOR, MALE; THROUGH HOLE; PRPC SERIES; STRAIGHT; 16PINS	
12	H2	—	1	PRPC012SFAN-RC	SULLINS ELECTRONICS CORP	PRPC012SFAN-RC	CONNECTOR, MALE; THROUGH HOLE; PRPC SERIES; STRAIGHT; 12PINS	
13	JU1-JU3	—	3	PEC033AAN	SULLINS	PEC033AAN	CONNECTOR, MALE; THROUGH HOLE; BREAKAWAY; STRAIGHT; 3PINS	
14	JU5	—	1	PEC02DAAN	SULLINS ELECTRONIC CORP.	PEC02DAAN	CONNECTOR, MALE; THROUGH HOLE; BREAKAWAY; STRAIGHT; 4PINS	
15	L1A	—	1	LQW18ASN6J0Z	MURATA	5.6NH	INDUCTOR; SMT (0603); WIREWOUND; 5.6NH; 5%; 0.7A	
16	L2	—	1	LQW18AN18N8J0Z	MURATA	18NH	INDUCTOR; SMT (0603); WIREWOUND; 18NH; 5%; 1.4A	
17	R6-R8	—	3	CRCW0603000020	VISHAY DALE	0	RESISTOR; 0603; 0Ω; 0%; JUMPER; 0.1W; THICK FILM	
18	R14, R15	—	2	ERJ-3GEYJ472V	PANASONIC	4.7K	RESISTOR; 0603; 4.7KΩ; 5%; 200PPM; 0.10W; THICK FILM	
19	R16	—	1	ERJ-3EKF1003	PANASONIC	100K	RESISTOR; 0603; 100KΩ; 1%; 100PPM; 0.1W; THICK FILM	
20	RFOUT	—	1	142-0701-851	JOHNSON COMPONENTS	142-0701-851	CONNECTOR, END LAUNCH JACK RECEPTACLE; BOARDMOUNT; STRAIGHT THROUGH; 2PINS;	
21	SU1-SU5	—	5	NPC02SXON-RC	SULLINS ELECTRONICS CORP.	NPC02SXON-RC	CONNECTOR; FEMALE; MINI SHUNT; 0.100IN CC; OPEN TOP; JUMPER; STRAIGHT; 2PINS	
22	U1	—	1	MAX41464GUB+	MAXIM	MAX41464GUB+	EVKIT PART - IC; MAX41464GUB+; TSSOP10; 300-960MHZ (G)FSK TRANSMITTER WITH I2C INTERFACE; PACKAGE OUTLINE DRAWING 21-0061; PACKAGE CODE: U10-2; PACKAGE LAND PATTERN: 90-0330	
23	VDD	—	1	5010	KEYSTONE	N/A	TEST POINT; PIN DIA = 0.125IN; TOTAL LENGTH = 0.445IN; BOARD HOLE = 0.063IN; RED; PHOSPHOR BRONZE WIRE SIL;	
24	Y1	—	1	TSX-3225 16.000MF18X-AC0	EPSON	16MHZ	CRYSTAL; SMT (3225) 3.2X2.5; 9PF; 16MHZ; +/-10PPM; +/-18PPM	
25	U2	—	1	MAXREFDES100HDK#	MAXIM		ASSEMBLY; MOD; HEALTH SENSOR PLATFORM; MAXREFDES100HDK#	
26	U2	—	1	1675	ADAFRUIT INDUSTRIES		CONNECTOR; FEMALE-FEMALE; WIREMOUNT; 1.27MM IDC CABLE-150MM; WIREMOUNT; 10PINS	
27	U2	—	1	3025010-03	QUALTEK ELECTRONICS CORP		CONNECTOR; MALE-MALE; WIREMOUNT; USB 4P-MICRO USB 5P 915MM; WIREMOUNT; 5PINS	
28	PCB	—	1	MAX41464868MHZ	MAXIM	PCB	PCB;MAX41464868MHZ	
29	U2	DNI	1	MAX32630FTHR	MAXIM	MAX32630FTHR	EVKIT PART-MODULE; MAX32630FTHR; RAPID DEVELOPMENT PLATFORM;	
30	J1	DNI	1	PPPC161LFBN-RC	SULLINS ELECTRONICS CORP.	PPPC161LFBN-RC	CONNECTOR; FEMALE; THROUGH HOLE; LFB SERIES; 2.54MM CONTACT CENTER; STRAIGHT; 16PINS	
31	J3	DNI	1	PPPC121LFBN-RC	SULLINS ELECTRONICS CORP	PPPC121LFBN-RC	CONNECTOR; FEMALE; THROUGH HOLE; HEADER FEMALE; STRAIGHT; 12PINS	
32	MISC1	DNI	1	3025010-03	QUALTEK ELECTRONICS CORP	3025010-03	CONNECTOR; MALE; USB-A_MINI-B; USB 4P(A)JM - USB MINI 5P(B)JM; STRAIGHT; 36IN	
33	C9	DNP	0	C0603C474K4RAC; GRM188R71C474K	KEMET;MURATA	0.47UF	CAPACITOR; SMT; 0603; CERAMIC; 0.47uF; 16V; 10%; X7R; -55°C to + 125°C; 0 ±15%/°C MAX.	
34	C10	DNP	0	C1608C0G1H103J; CGA3E2C0G1H103J080AD; GRM188SC1H103JA01	TDK;TDK;MURATA	0.01UF	CAPACITOR; SMT (0603); CERAMIC CHIP; 0.01UF; 50V; TOL = 5%; TG = -55°C to +125°C; TC = COG	
35	D1	DNP	0	LTST-C193KRKT-5A	LITE-ON ELECTRONICS INC	LTST-C193KRKT-5A	DIODE; LED; WATER CLEAR; RED; SMT; VF=2V; IF=0.005A	
36	JU4	DNP	0	TSW-106-25-T-S-RA	SAMTEC	TSW-106-25-T-S-RA	CONNECTOR, MALE; THROUGH HOLE; 0.025IN SQ POST HEADER; RIGHT ANGLE; 6PINS	
37	L1B	DNP	0	LQW18ASN1J0Z	MURATA	5.1NH	INDUCTOR; SMT (0603); WIREWOUND; 5.1NH; 5%; 0.70A	
38	R1-R5	DNP	0	CRCW0603000020	VISHAY DALE	0	RESISTOR; 0603; 0Ω; 0%; JUMPER; 0.1W; THICK FILM	
39	R9	DNP	0	CRCW0603470RFK; ERJ-3EKF4700	VISHAY DALE;PANASONIC	470	RESISTOR; 0603; 470Ω; 1%; 100PPM; 0.10W; THICK FILM	
40	R10-R13	DNP	0	CRCW06031M00JN	VISHAY DALE	1M	RESISTOR; 0603; 1MΩ; 5%; 200PPM; 0.10W; METAL FILM	
41	R17	DNP	0	ERJ-3GEYJ472V	PANASONIC	4.7K	RESISTOR; 0603; 4.7KΩ; 5%; 200PPM; 0.10W; THICK FILM	
42	R18	DNP	0	CRCW040210R0JN	VISHAY DALE	10	RESISTOR; 0402; 10Ω; 5%; 200PPM; 0.063W; THICK FILM	
TOTAL			43					

MAX4146x EV Kit Schematics

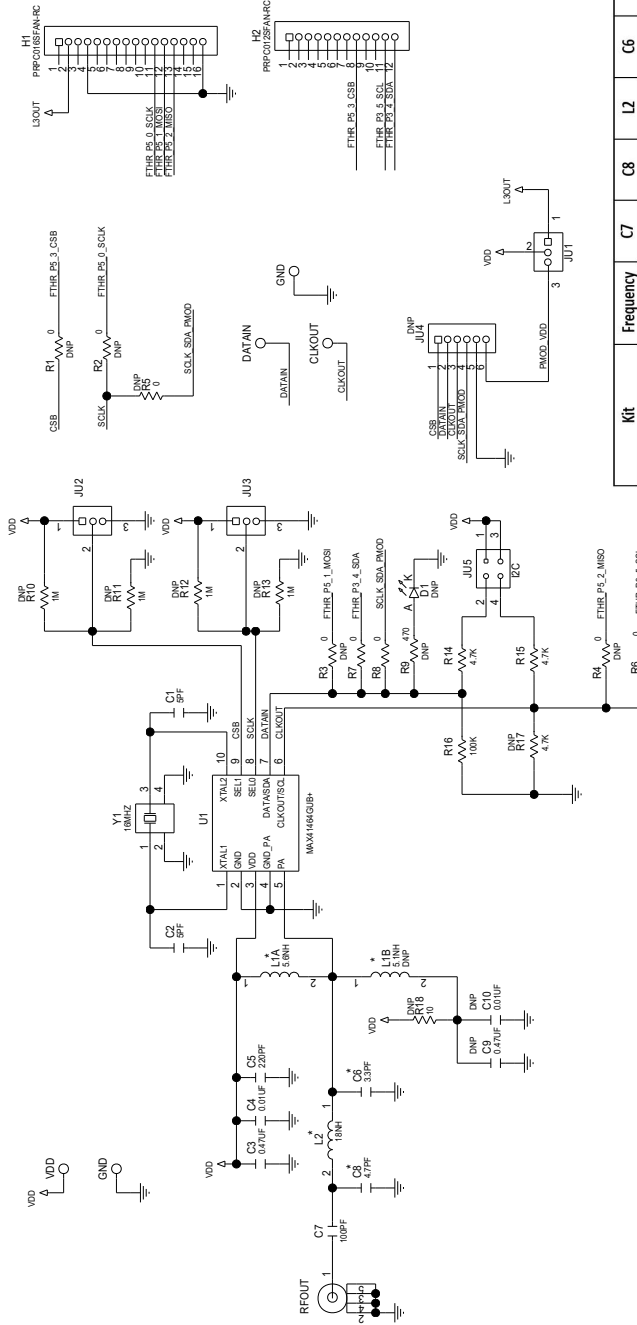

Kit	Frequency	C7	C8	L2	C6	L1A	L1B
MAX41461E/KIT-315	315MHz	100pF	8.2pF	5.1nH	4.7pF	47nH	DNP
MAX41462E/KIT-434	434MHz	100pF	8.2pF	30nH	5.6pF	24nH	DNP
MAX41464E/KIT-868	868MHz (default)	100pF	4.7pF	18nH	3.3pF	5.6nH	DNP
MAX41463E/KIT-915	915MHz	100pF	3.9pF	12nH	open	5.1nH	DNP
MAX41460E/KIT-915	915-HP	100pF	10pF	5.6nH	10pF	6.2nH	TBD

Product	BOM	Description
MAX41460	DNP: JU2, JU3, R6, R7, R8 Installs: R1, R2, R3, R4, R5	SPI interface to FTHR and PMOD
MAX41461-64(Preset)	DNP: R1, R2, R3, R4, R5 Installs: JU5	SEL pins to jumpers, Preset/I2C jumper Selection and I2C Interface to FTHR and PMOD
MAX41461-64(I2C)	Installs: JU2, JU3, R6, R7, R8 Short: 1-2, 3-4	Interface to FTHR and PMOD
All	DNP: R9, D1, JU4	PMOD and LED are not included by default

MAX4146x EV Kit PCB Layout Diagrams

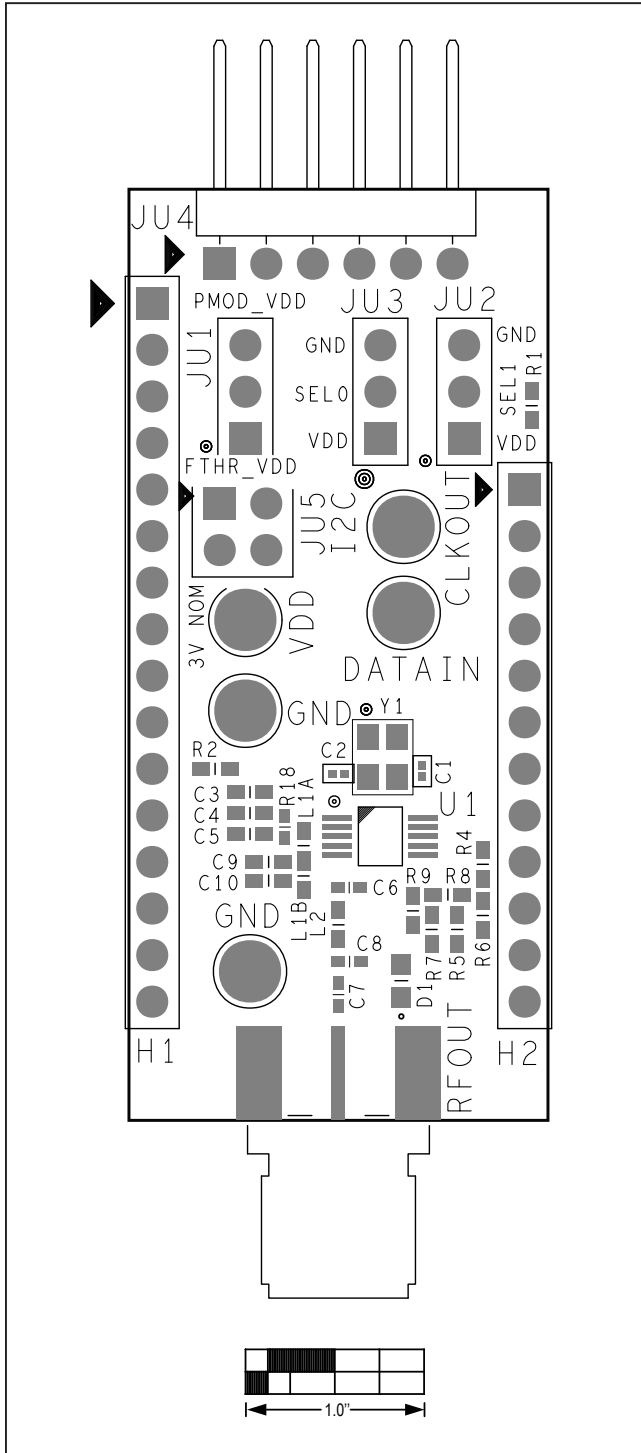

MAX4146x EV Kit Component Placement Guide—Top Silkscreen

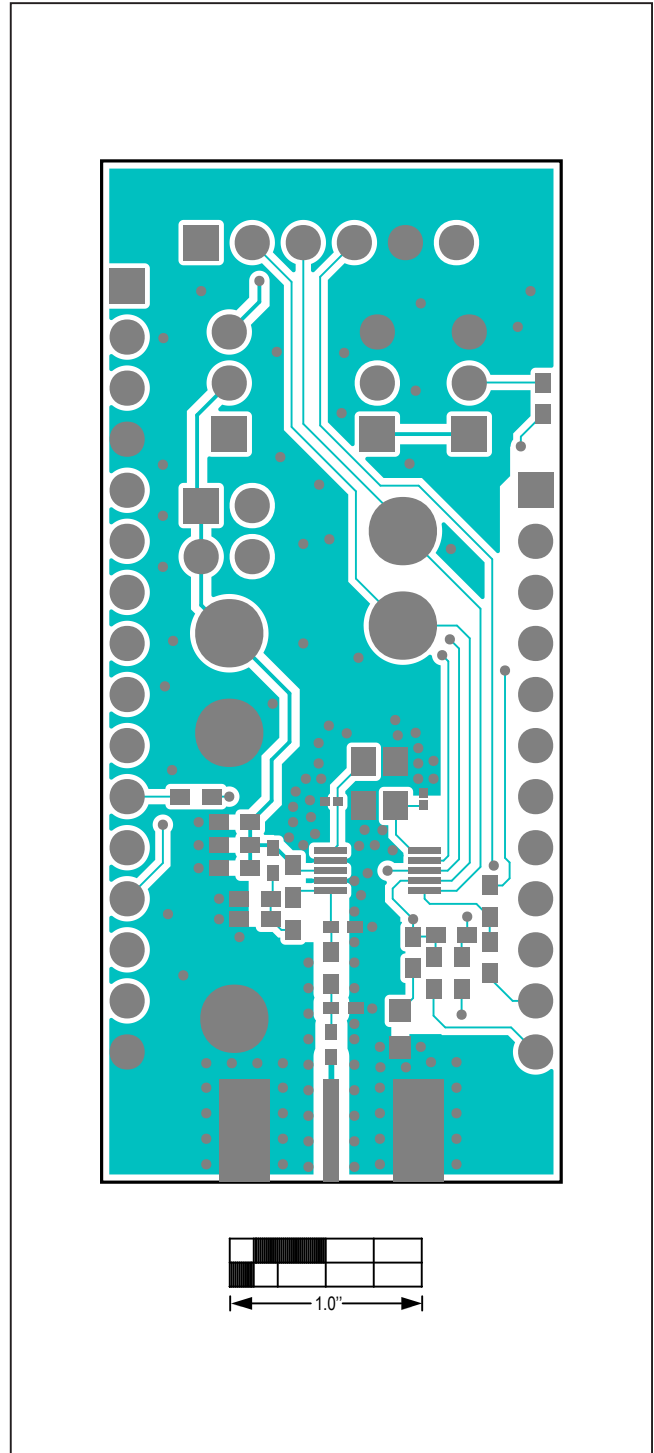

MAX4146x EV Kit PCB Layout—Top Layer

MAX4146x EV Kit PCB Layout Diagrams (continued)

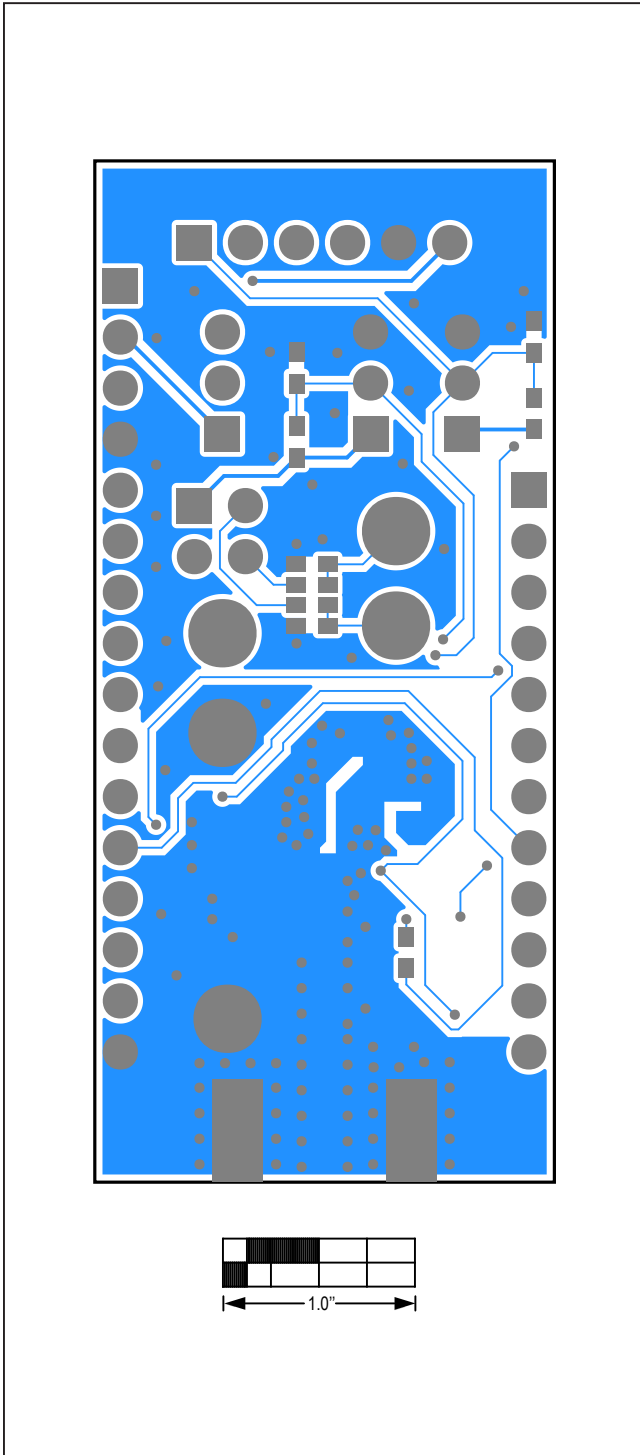

MAX4146x EV Kit PCB Layout—Bottom Layer

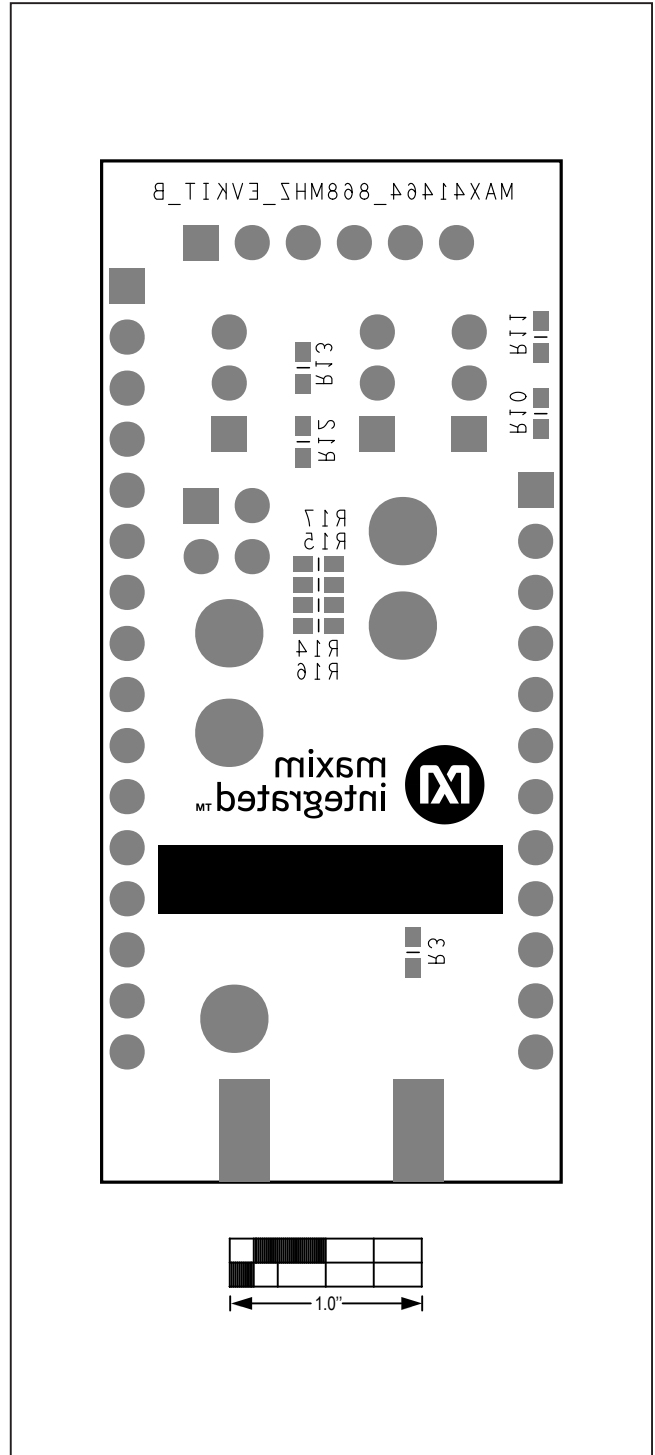

MAX4146x EV Kit PCB Layout—Bottom Silk Layer

Appendix I – Detailed Software, Firmware, and Driver Installation Procedures

Download the MAX4146x EV kit Software Package

This software and firmware are available from the www.maximintegrated.com website.

- 1) Login to your MyMaxim account on the website

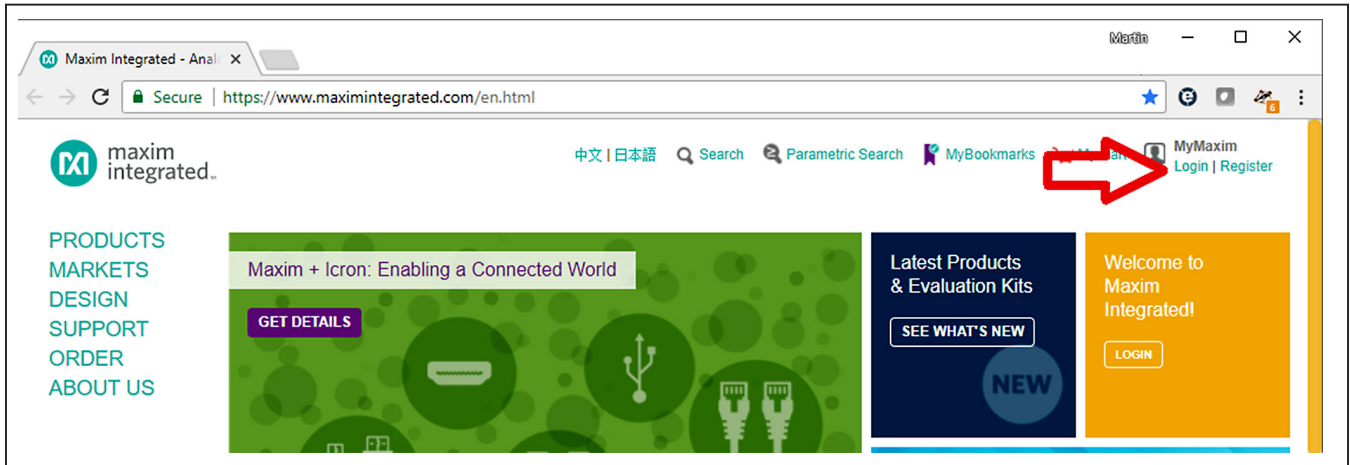

- 2) Click on the magnifying glass and search for the **MAX41460** or similar part

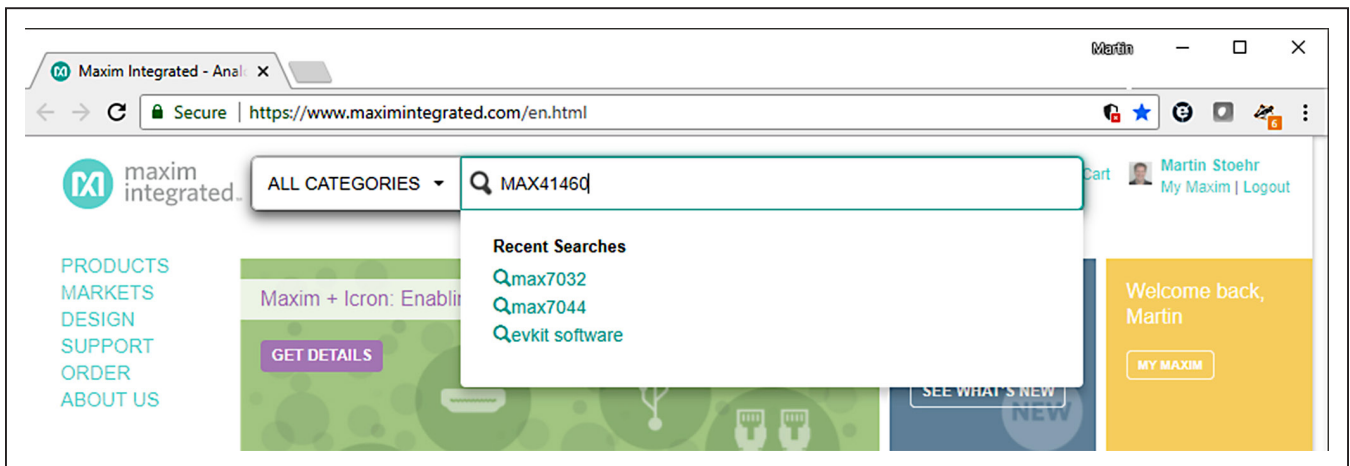

- 3) Click on the "Design Resources" link for the device or the EVKIT or click on the Design Resources tab on the product web page

Battery Management (1)
Display Power & Control (1)
Charge Pumps (1)
Switching Regulators (17)
Supervisors, Voltage Monitors,
Sequencers (12)
LED Drivers (2)
Protection And Control (5)
MOSFET Drivers And
Controllers (2)
ANALOG (21) >
Audio (3)
Data Converters (4)
Voltage Reference (1)
Sensors And Sensor Interface
(5)
INTERFACE (13) >
Transceivers (3)
High Speed Signaling (1)
Level Translators (3)
Signal Line Protection ICs (2)
COMMUNICATIONS (26) >
Wireless & RF (25)
DIGITAL (6)

Search results for > max1471

PRODUCT RESULTS ▲
93 **Products** results for "max1471" | Viewing 1-4 of 93 | [Show more >](#)

MAX1471
MAX1471 315MHz/434MHz Low-Power, 3V/5V ASK/FSK Superheterodyne Receiver - Maxim

[Data Sheet](#) | [Key Specs](#) | [Design Resources](#) | [Related Packaging](#)

VIEW PARTS TO
ORDER ▼

MAX1471EVKIT-315
MAX1471EVKIT-315 Evaluation Kit for the MAX1471 - Maxim

[Data Sheet](#) | [Key Specs](#) | [Design Resources](#) | [Related Packaging](#)

4) Click on the appropriate software link:

PRODUCTS
POWER
ANALOG
INTERFACE
COMMUNICATIONS
DIGITAL
INDUSTRIES
ALL
WHAT'S NEW
MARKETS
DESIGN
SUPPORT
ORDER
ABOUT US

Maxim > Products > Communications > Wireless and RF > MAX1471

MAX1471

315MHz/434MHz Low-Power, 3V/5V ASK/FSK Superheterodyne Receiver

300MHz to 450MHz Superheterodyne ASK/FSK Receiver with Integrated Image Rejection Operates from 3V or 5V Supply

[Data Sheet](#) [Subscribe](#) [Active: In Production.](#) [Maxim Confidential](#)

OVERVIEW **KEY SPECIFICATIONS** DESIGN RESOURCES QUALITY AND ENVIRONMENTAL
ORDER

[MAX1471EVKIT-315: Evaluation Kit for the MAX1471](#)
[MAX1471EVKIT-433: Evaluation Kit for the MAX1471](#)

Technical Documents
Tutorial 5436 [Getting Started with a Radio Design](#)
Tutorial 5428 [Squelch in ISM-RF Receivers](#)
Tutorial 5426 [Baseband Calculations for ISM-RF Receivers](#)
Tutorial 5422 [Crystal Calculations for ISM-RF Products](#)
Tutorial 5417 [How to Optimize an ISM Radio Frequency \(RF\) System](#)

Tools & Models
CAD and Layout
[MAX1471 Gerber File](#)
Software
[MAX1471 EVKIT Software](#)
[MAX1471 EVKit Software](#)

5) Click the file link on the software landing page to download the MAX4146x EV kit package.

DESIGN
ORDER
SUPPORT
ABOUT US

EV KIT SOFTWARE

Don't see your EV kit software here? Please use the Site Search to go directly to the EV kit or IC product folder page, and you'll find it on the Design Resources tab.

MAX1471 EVKIT Software

Software Version: 1.1
Filename: 1471R11.ZIP (898KB)
Description:
Operating Systems Supported: Windows 98/2000/XP
Required Hardware: MAX1471EVCMOD2 (MAX1471EVKIT plus CMOD232)
Related Data Sheets: [MAX1471 Product folder](#)

Notes: Download and unzip file. Run install.exe to install program.

6) Review the Maxim Software License Agreement (SLA) and accept the terms by clicking on the Accept button.

The screenshot shows the 'EV Kit Software - License Agreement Portal' on the Maxim Integrated website. The page includes a navigation menu on the left with links for PRODUCTS, SOLUTIONS, DESIGN, ORDER, SUPPORT, and ABOUT US. The main content area displays the 'MAXIM INTEGRATED PRODUCTS, INC. SOFTWARE LICENSE AGREEMENT' text. Below the agreement text is a link to 'Download Printable Version'. A 'My contact information' form is visible, with fields for Name, Company, Address, City, State/Province, Postal, Country, Email, Phone, and Fax. The 'Name' field is filled with 'Martin Stoehr' and 'Company' with 'Maxim Integrated'. At the bottom of the form, there are 'Accept' and 'Decline' buttons. A red arrow points to the 'Accept' button.

7) Save the EVKIT distribution package to your desktop or other accessible location for later install.

MAX4146x Evaluation Kit

Evaluates: MAX41460
MAX41463
MAX41464

Install the MAX4146x EV kit GUI Software

This software and firmware are available from the www.maximintegrated.com website. Refer to the “[Download the MAX4146x EV kit Software Package](#)” section for information on obtaining the latest firmware from Maxim.

This process should take less than 10 minutes after downloading the software, firmware, and driver package.

- 1) Extract the Setup_MAX4146X_V1.0.0_EVKit_SW.zip to a working folder

- 2) Double-Click the MAX4146xGUISetupV01.msi setup file and follow Setup Wizard prompts:
 - a. Click <Next>
 - b. Use the default Destination folder and click <Next>
 - c. Install the software by clicking the <Install> button
 - d. Click <Finish> when the setup process is complete

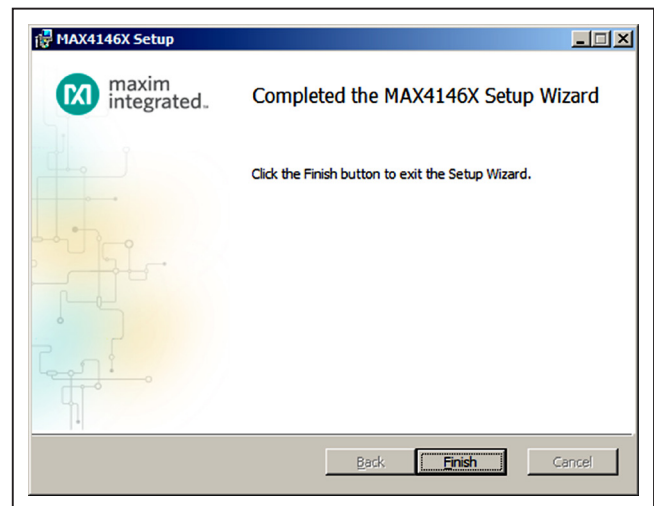
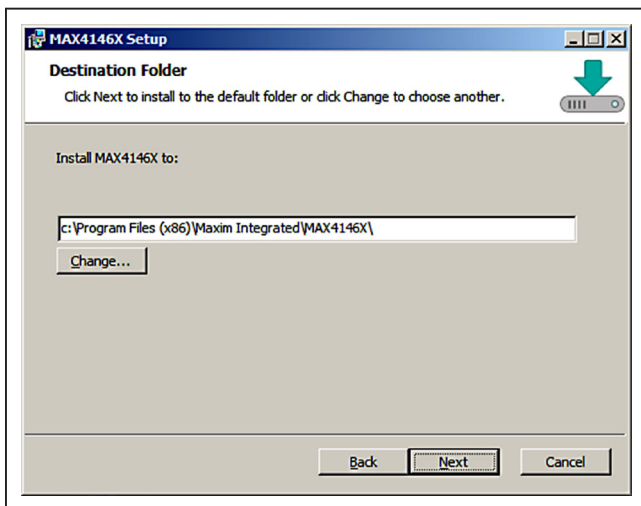
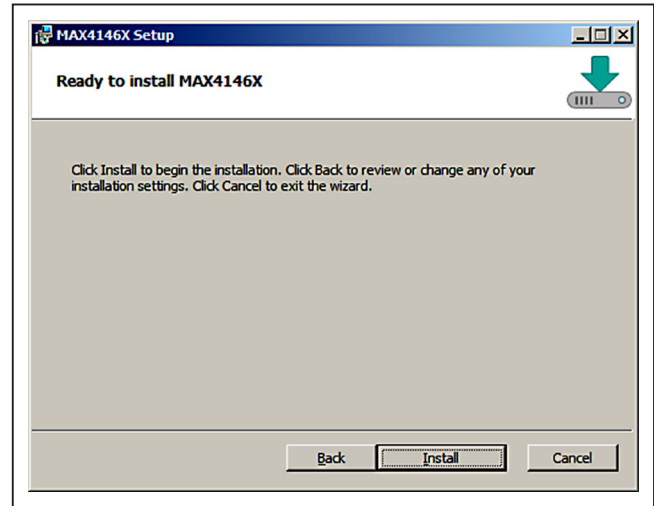
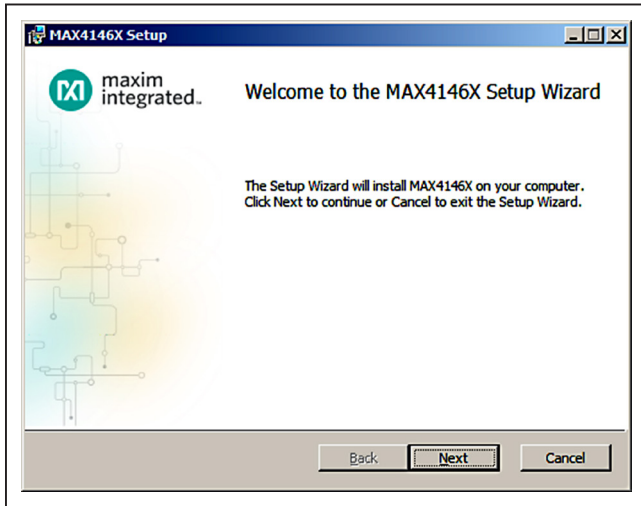

Program the MAX32630FTHR Board with the MAX4146x Firmware

The FTHR board firmware comes pre-installed with every MAX4146x EV kit. This section describes how to install that firmware for development or update purposes.

This software and firmware are available from the www.maximintegrated.com website. Refer to the “[Download the MAX4146x EV kit Software Package](#)” section above for information on obtaining the latest firmware from Maxim.

- 1) Connect the MAX32630FTHR to the MAXREFDES100HDK or the MAX32625PICO
 - a. Use the fine pitch 10pin ribbon cable to connect the boards from the SWD (J3) header on the HDK to J4 on the MAX32630FTHR.

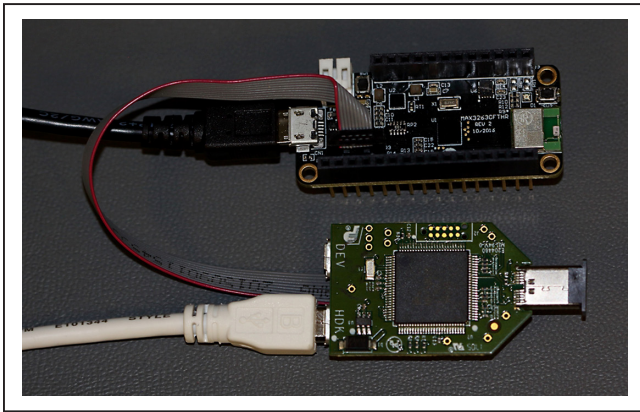

MAXREFDES100HDK DAPLINK

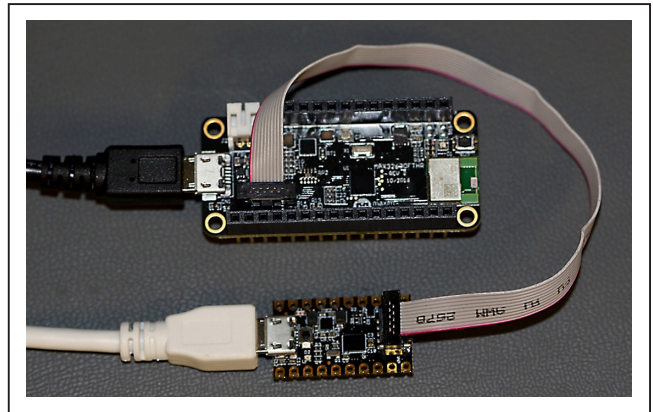

MAX32625PICO DAPLINK

- 2) Connect the MAX32630FTHR to a power source
 - a. Use a micro-B USB cable to connect the MAX32630FTHR board to a suitable power source (no USB connectivity is required). [The black USB cable in the photos.] Alternatively, you can power the board from a charged battery as long as you remember to turn it on by pressing the power/reset button next to the battery connector. The board turns on automatically when powered from the USB supply.
 - b. The status LED on the FTHR board should be lit a steady red.
- 3) Connect the MAXREFDES100HDK/MAX32625PICO to a PC
 - a. Use a micro-B USB cable to connect the HDK to a PC, through the connector marked HDK. [The white USB cable in the photos.]
 - b. The status LED on the DAPLINK board will blink red when connecting.
 - c. After a few seconds of activity, the PC will recognize the DAPLINK as a standard USB drive.

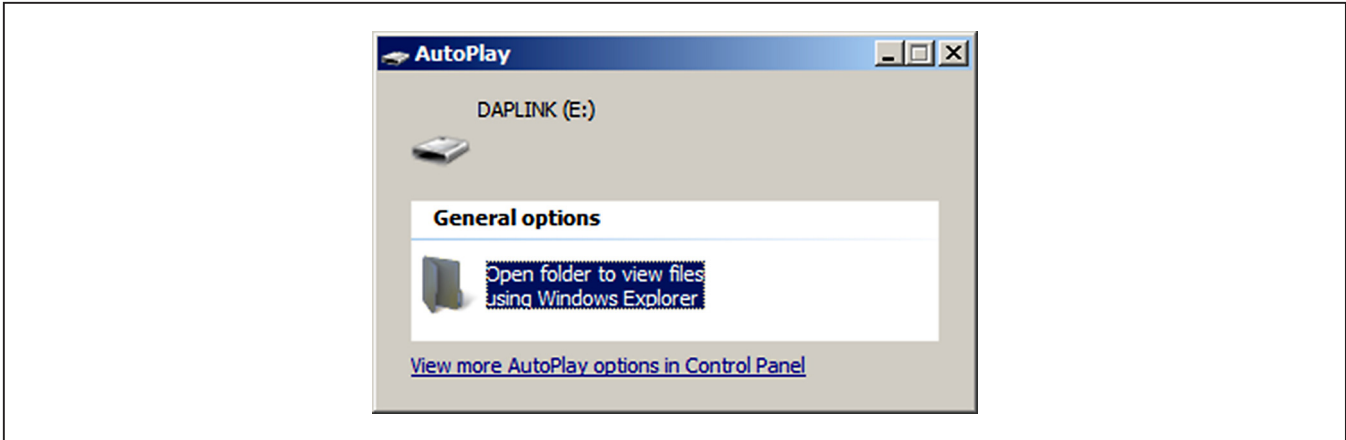

Windows 7/10 Example

- 4) Drag-and-drop or save the MAX4146x.bin program binary to the mbed or DAPLINK USB Drive
 - a. The FTTH board LED will shut off and the LED on the MAXREFDES100HDK / MAX32625PICO will slowly flash red as the FTTH board is being programmed.
 - b. Once the programming is complete, the DAPLINK USB Drive will disconnect from the PC and reconnect as a USB Drive again.
 - c. If the programming was successful, the contents of the DAPLINK USB Drive should include a DETAILS.TXT file. If an ERROR.TXT file exists on the drive, check that the FTTH board had power during the programming process and repeat steps 3 and 4.

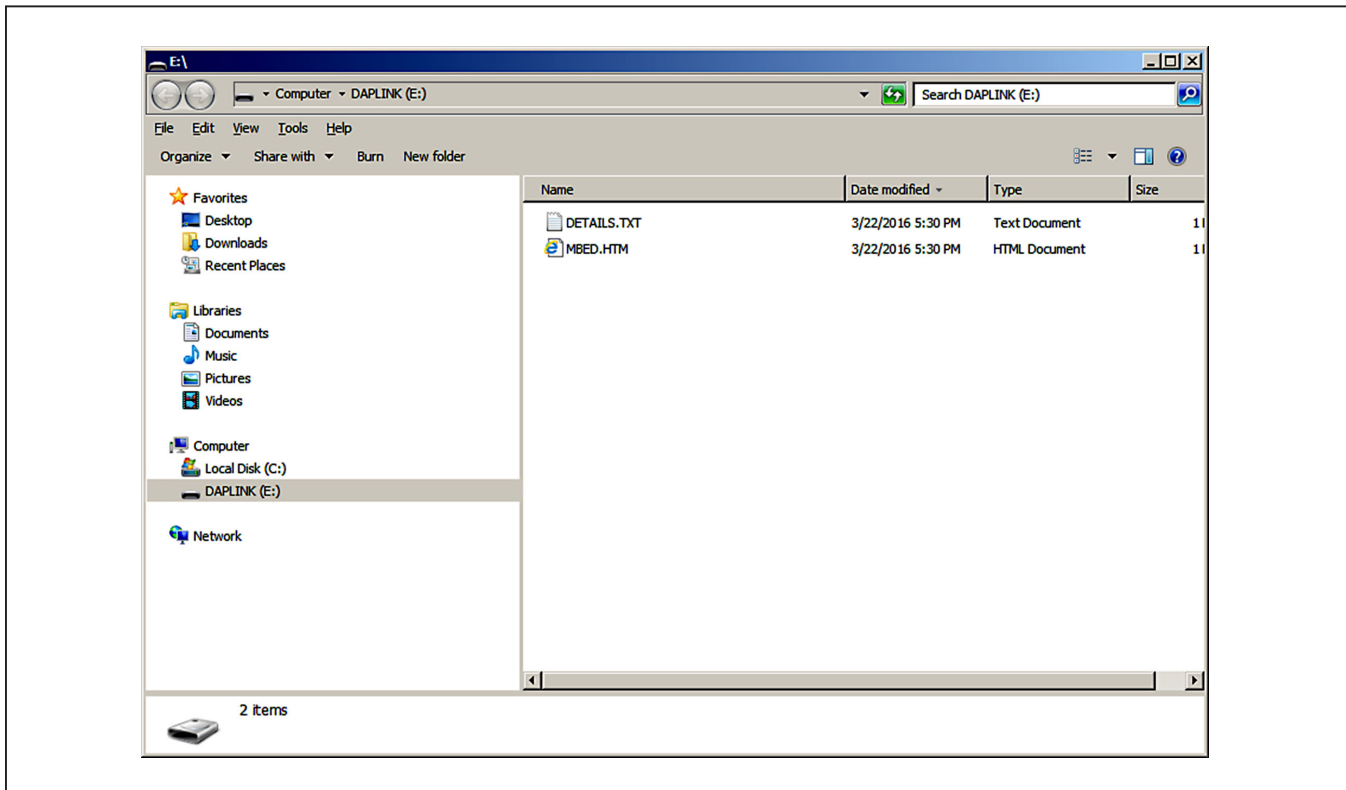

MAX4146x Evaluation Kit

Evaluates: MAX41460
MAX41463
MAX41464

- 5) To ready the FTTHR board for use, disconnect the DAPLINK board (ribbon cable) and press the Reset Button on the FTTHR board or disconnect the FTTHR board from the USB power supply.
 - a. When the Reset button is pressed, the microcontroller will restart and the newly programmed application will begin to run or you can disconnect and reconnect the USB cable if using a PC for power.

The latest information and these firmware update instructions can be found on the MAX32630FTTHR board mBed web site: <https://os.mbed.com/platforms/MAX32630FTTHR/> or by visiting the mBed home page (<https://www.mbed.com/>) and searching for “MAX32630FTTHR”.

If you do not have an mbed account, choose “Signup”, and create your mbed Account. Otherwise, log in with your normal username and password. This will give you access to the website, tools, libraries and documentation.

From: <https://os.mbed.com/teams/MaximIntegrated/wiki/MAXREFDES100HDK>

Note that the MAXREFDES100HDK hardware supports multiple mbed platforms, and the firmware needs to match the platform you are using to enable all the features. The virtual serial port and CMSIS-DAP debug adapter are universal, but the drag-n-drop programming must match the target platform being programmed. To update the firmware you need to put the board in maintenance mode and copy the new firmware image to the board. To put the board in maintenance mode you need to hold the button while the board is being connected to the computer at the HDK connector. This will activate maintenance mode and the board will appear to the computer as a thumb drive named “MAINTENANCE”. Drag and drop the new image onto the MAINTENANCE drive and the board will install the new firmware. When the update is complete, the disk will disconnect and reappear as a thumb drive named “DAPLINK”. There are links to the firmware images below.

Please Note: *The board can be sensitive to excess loading on the crystal which could prevent it from entering maintenance mode. We recommend holding the board by the edges when entering maintenance mode. It may be easier to hold the button while inserting the USB cable at the computer end, rather than trying to insert the cable into the micro USB connector.*

You must load the matching HDK image for the platform you are programming in order for drag-n-drop programming to work. For the MAX32630FTTHR DAPLINK Image:

https://os.mbed.com/media/uploads/switches/max32620_daplink_max32630fthr.bin

Update the MAX32630FTTHR Board Driver

The required driver is available from the www.maximintegrated.com website. Refer to the “[Download the MAX4146x EV kit Software Package](#)” section above for information on obtaining the latest driver from Maxim.

- 1) Connect the MAX32630FTTHR to the PC's USB port.
- 2) In Device Manager, right click Other devices => “CDC Device” or “mbed Composite Device”.

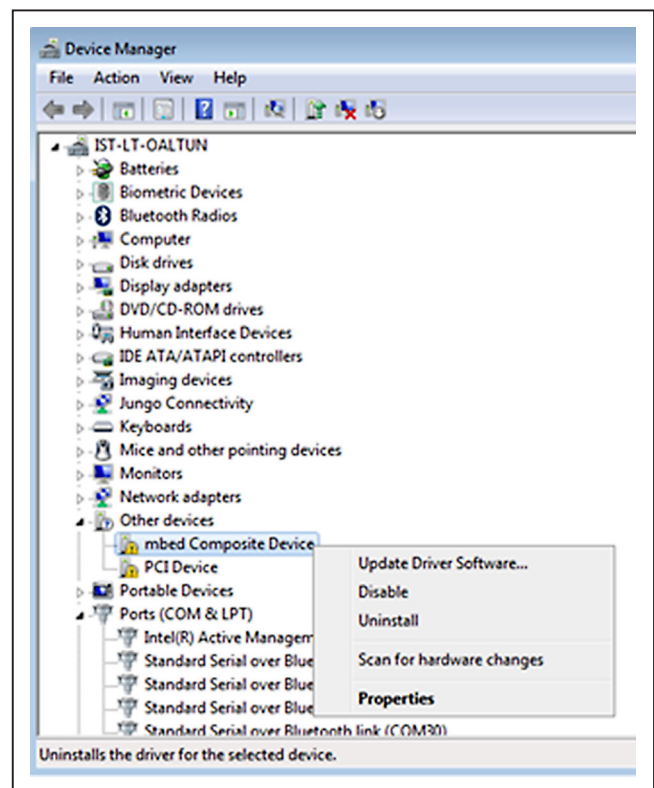

3) Click "Update Driver Software" then select Browse my computer for driver software.

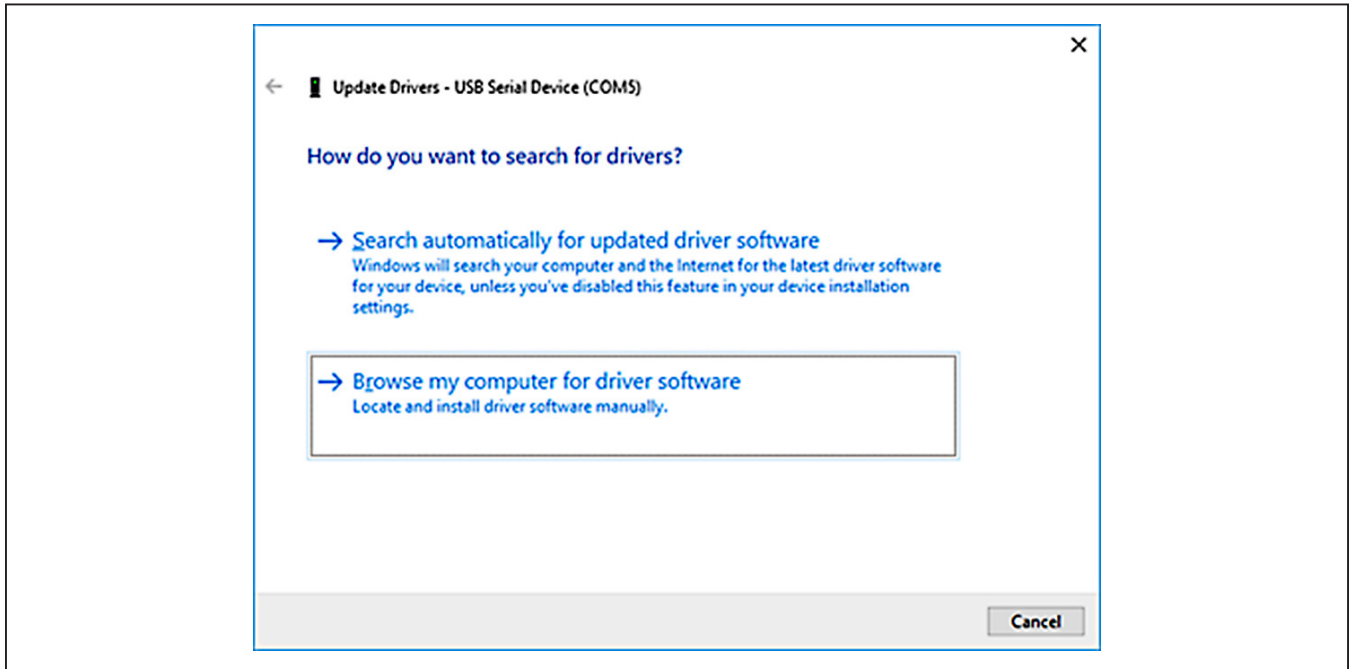

4) Select "Let me pick from a list of available drivers on my computer".

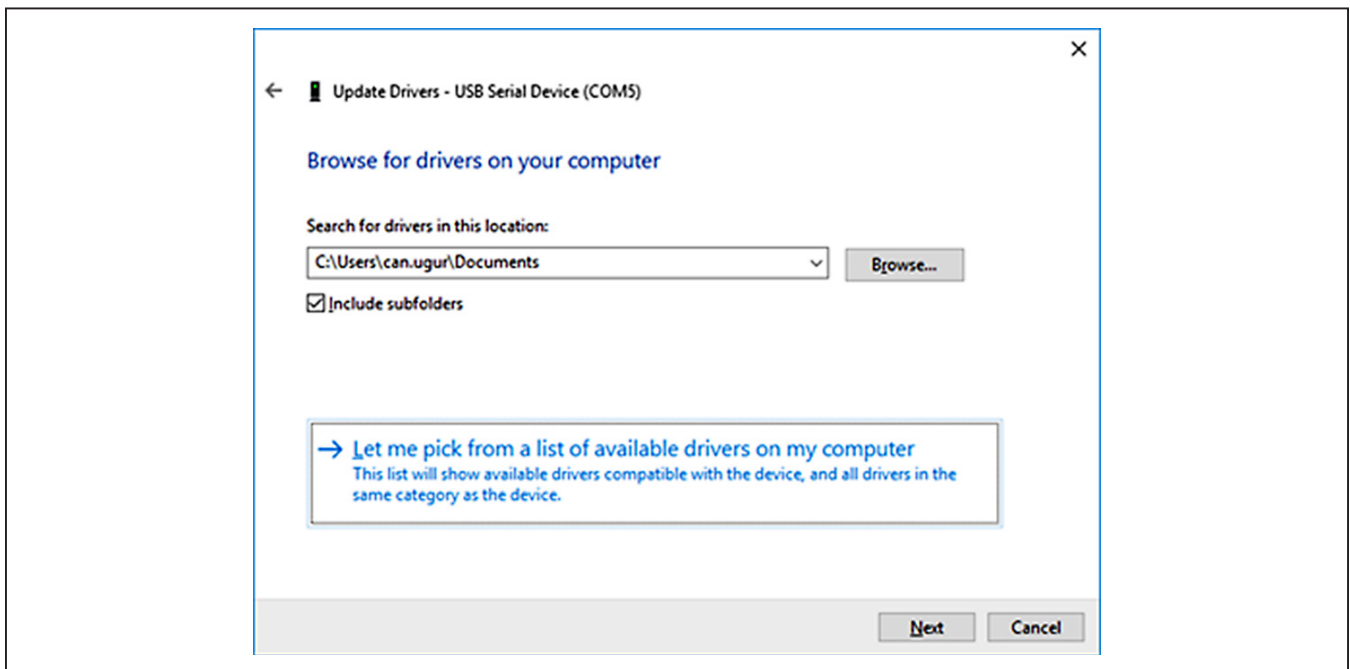

- 5) On a Windows 10 operating system, click <Have Disk...> button. On a Windows 7 system, click the “Show All Devices” check box.

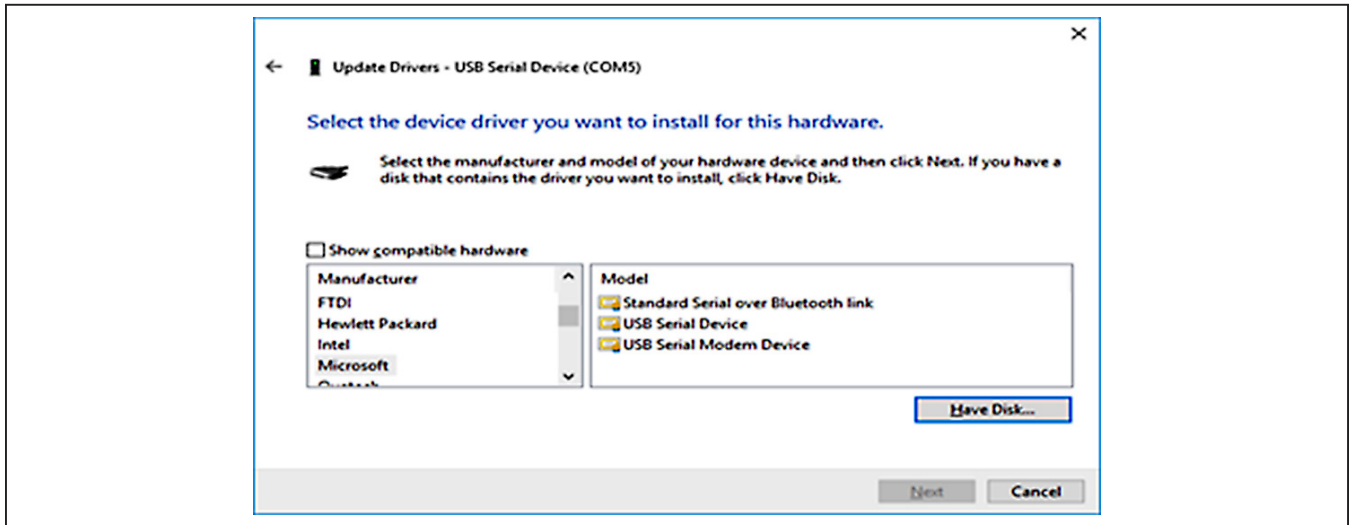

Win 10: <Have Disk...> Button.

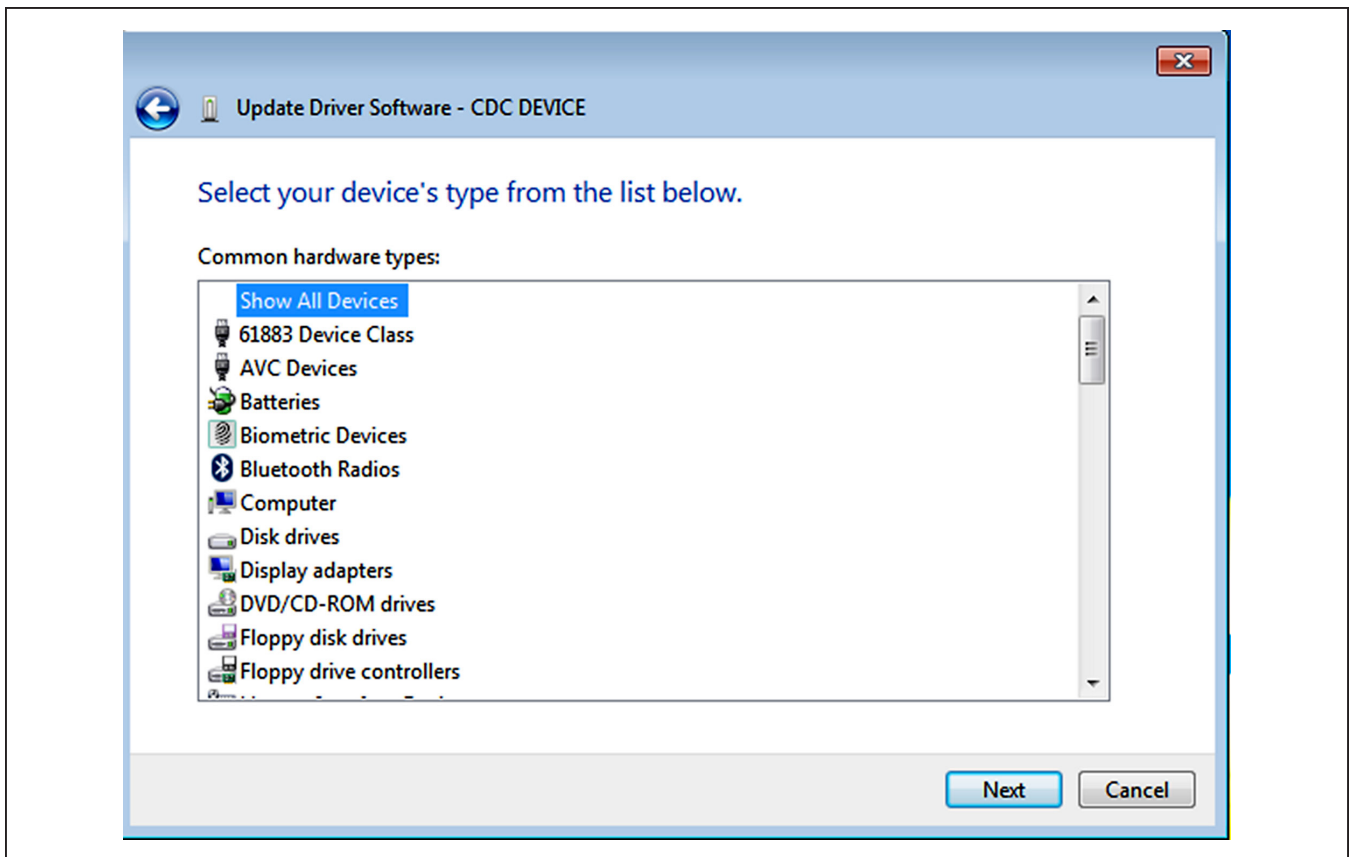

Win 7: "Show All Devices" Checkbox.

- 6) On a Win 10 system, skip to step 7; on a Win 7 system select a generic Manufacturer type (usually enclosed in brackets) and then click the <Have Disk...> button.

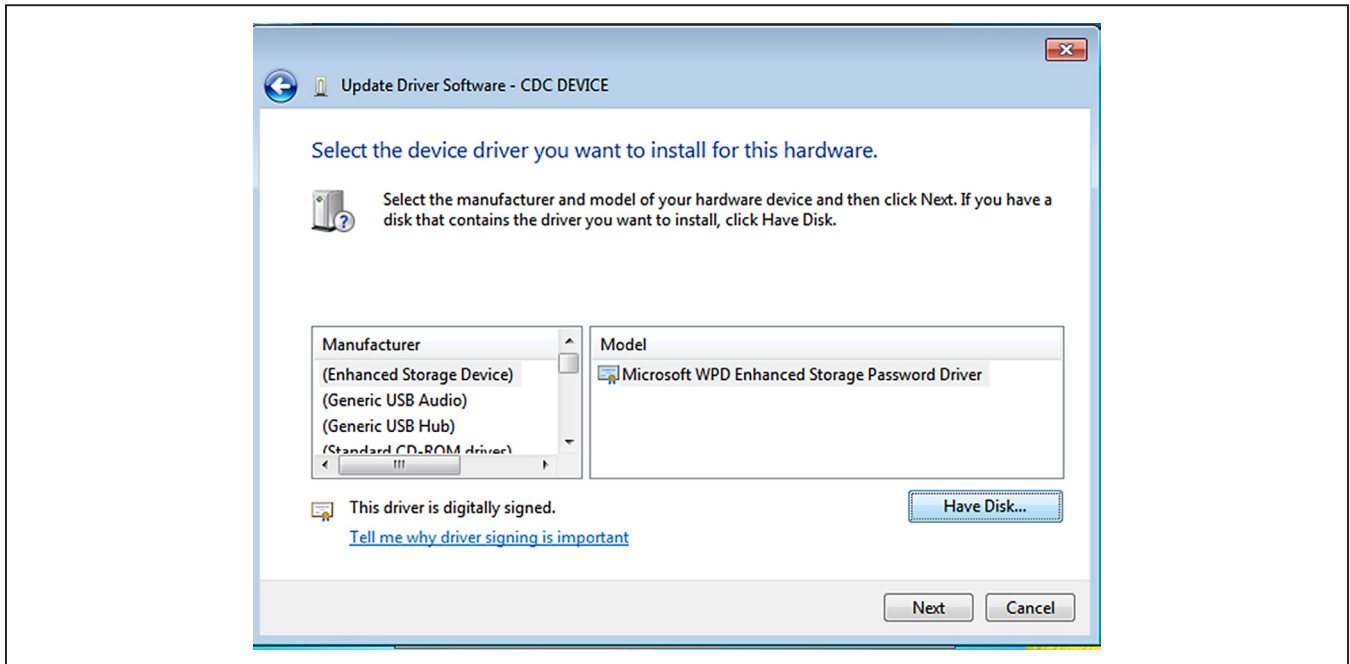

Win 7: Manufacturer Selection.

- 7) Browse the path of driver folder and for Win 10 click <OK>; for Win 7 select "maxim_usb-uart_adapter" then click <Open>.

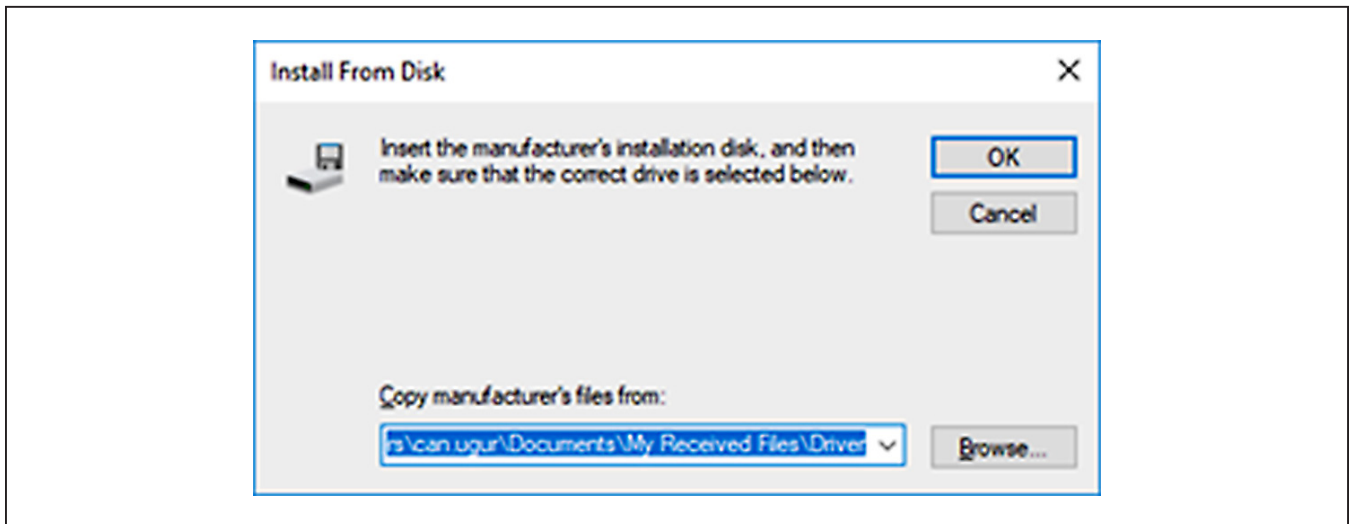

Win 10: browse to the path and click <OK>.

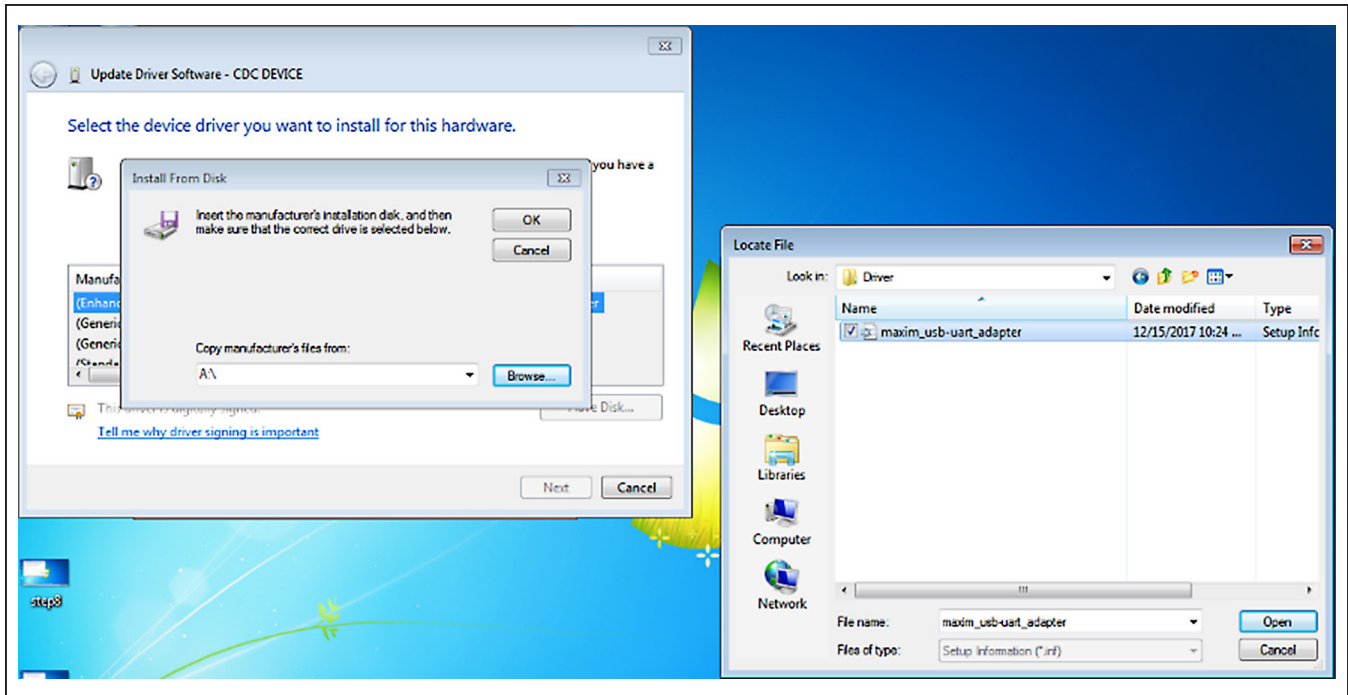

Win 7: select driver, click <Open>.

8) Click Next.

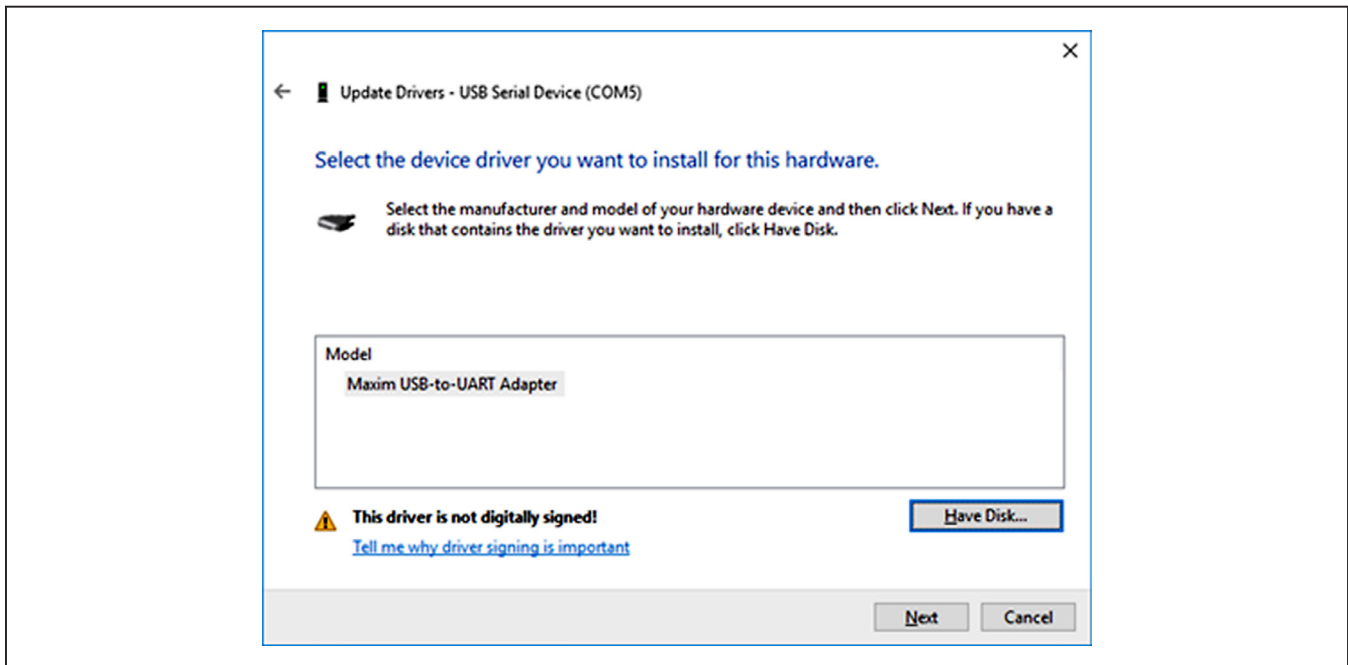

9) Ignore the warnings and click → Install...

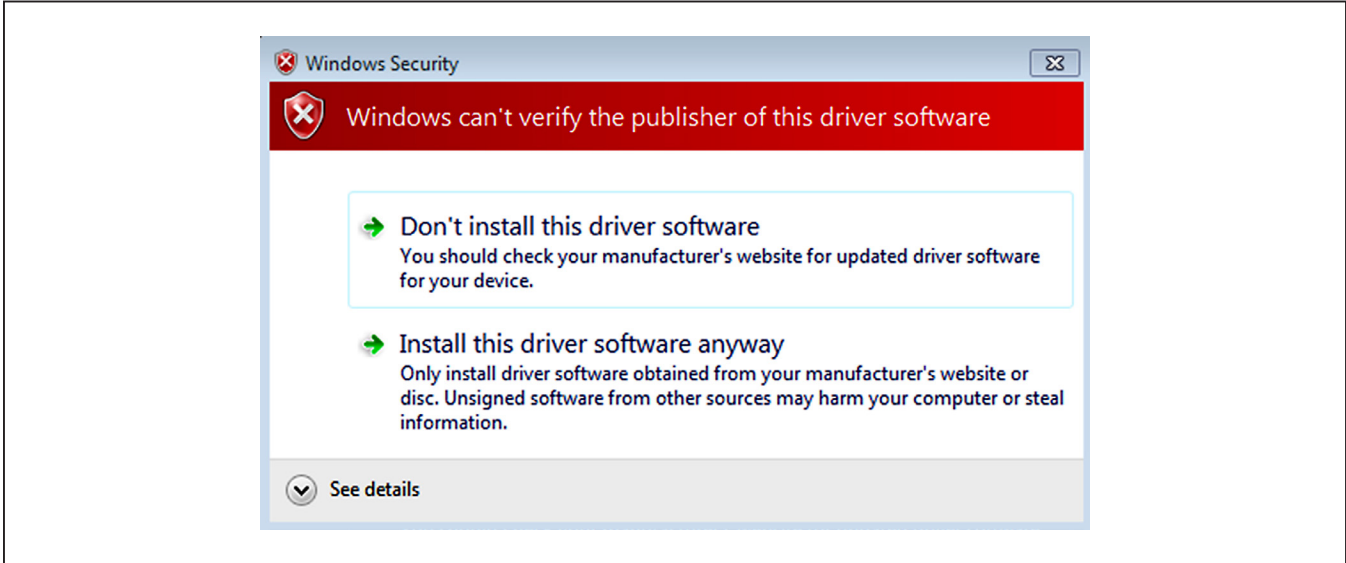

Win 10 and Win 7 Unverified Publisher Warning.

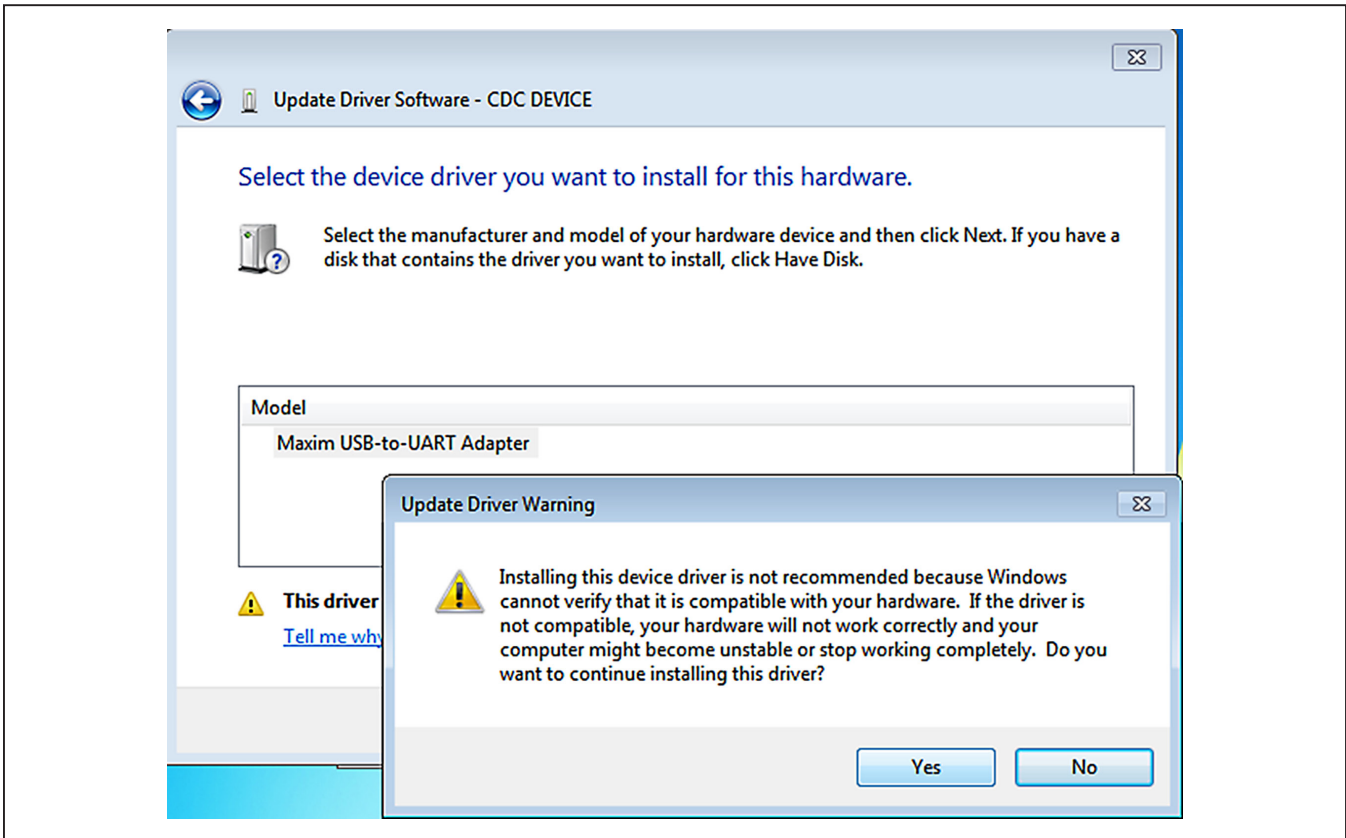

Win 7 "not recommended" Warning.

Appendix II – Hardware Modifications

I²C Pullup Resistors

To accommodate the various operating modes of the MAX4146x products on one board, the shared digital pins have many interface modes over which they operate. The DATAIN net is the most dynamic of these interfaces, serving three functions:

- 1) DATA input for transmission in preset mode for the MAX41461–MAX41464 parts.
- 2) SDA when MAX41461–MAX41464 parts are configured for I²C mode.
- 3) SDI or MOSI for SPI control of the MAX41460 and as DATA input when transmitting.

With preset parts (MAX41461–MAX41464) used in preset mode, the DATA pin must be held low during power-up of the device. A light pulldown resistor: R16, 100kΩ to ground satisfies this requirement.

To properly establish the open-drain topology of the two-pin serial interface the user must have the SDA and SCL lines pulled-up to the supply voltage. The resistor footprints: R14 and R15 are provided on the MAX4146x EV kit for this purpose. By connecting JU5 (1-2 and 3-4) both lines will be pulled-up to the VDD supply.

These pullups should only be connected when the preset pins (SEL0 and SEL1) are both connected to ground, thus selecting the I²C interface mode of the MAX4146x.

It should be noted that the FTHR board also has footprints for I²C pullup resistors at R6 and R11. Both sets of

pullup resistors (on the FTHR board and the MAX4146x EV kit) should not be populated simultaneously, otherwise incorrect I²C signal levels may result. Likewise, if other I²C slaves are added to the bus, only one set of pullup resistors should be used.

Matching Network

For optimal performance of the transmitter PA, the antenna matching network should be tuned to the operating frequency of the radio.

To change the tuning of the matching network, two inductors (L1 and L2) and two capacitors (C6 and C7) should be adjusted according to [Table A2-1](#):

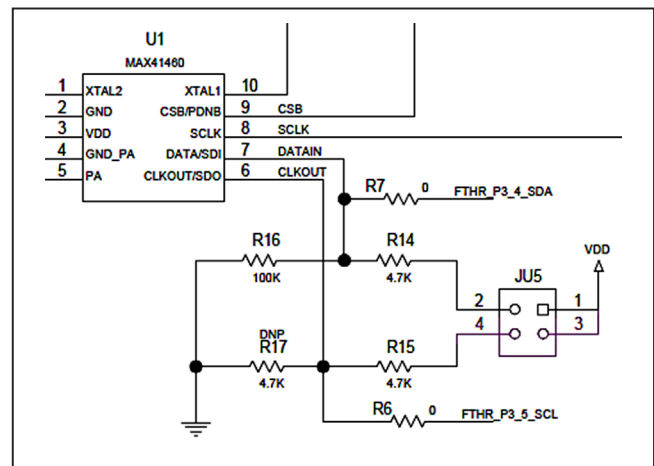

Figure A2-1. I²C Pullup Resistors.

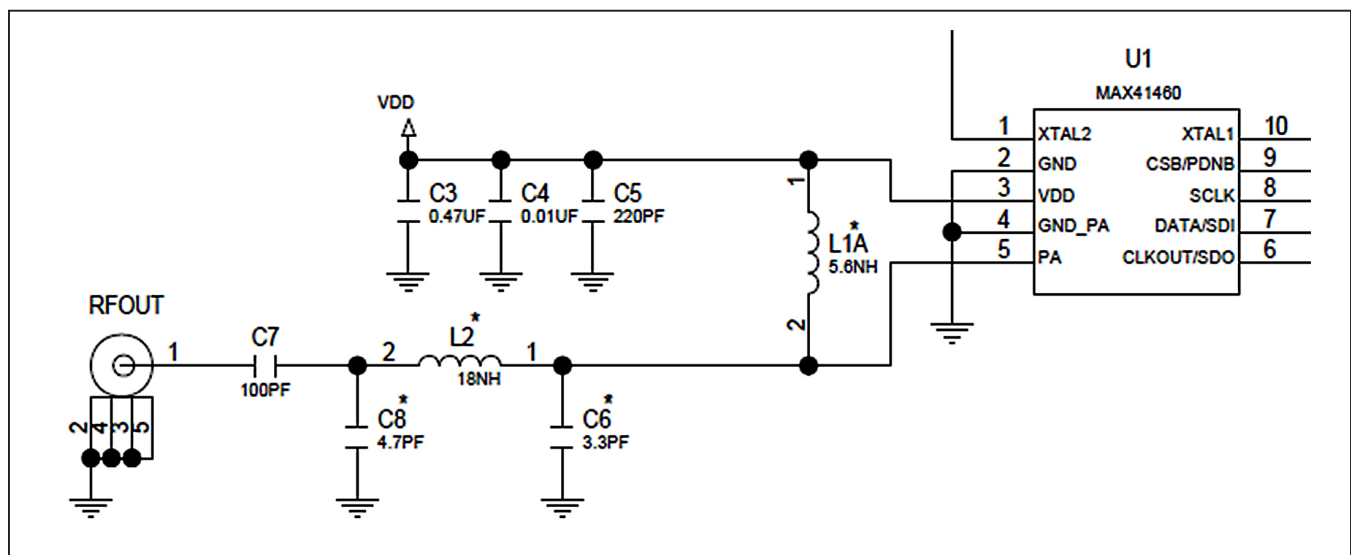

Figure A2-2. Matching Network.

Table A2-1. MAX4146x EV Kit Matching Network Component Values

KIT	fC	POUT	BOOST*	LOAD IMPEDANCE	C7	C8	L2	C6	L1A
MAX41461EVKIT-315	315MHz	+13dBm	—	165Ω	100pF	8.2pF	51nH	4.7pF	47nH
	315MHz High-Power	+16dBm	0	68Ω	100pF	8.0pF	27nH	8.0pF	30nH
MAX41462EVKIT-434 MAX41460EVKIT# MAX41464EVKIT#	434MHz	+13dBm	—	180Ω	100pF	8.2pF	30nH	5.6pF	24nH
	434MHz High-Power	+16dBm	0	57Ω	100pF	8.0pF	19nH	7.0pF	24nH
MAX41464EVKIT-868	868MHz	+11dBm	—	190Ω	100pF	4.7pF	18nH	3.3pF	5.6nH
	868MHz High-Power	+16dBm	1	33Ω	100pF	3.0pF	9.1nH	3.3pF	3.0nH
MAX41463EVKIT-915	915MHz	+11dBm	—	190Ω	100pF	3.9pF	12nH	open	5.1nH
MAX41460EVKIT-915	863-928MHz High-Power*	+16dBm	1	34Ω	100pF	10pF	5.6nH	10pF	6.2nH

*PA boost mode enabled through the SHDN register (0x05), PA_BOOST bit [0]

Additional Harmonic Filtering

Operating the MAX4146x in a high-power mode may impact ESTI compliance and will be particularly noticeable when using a device in the 434MHz band. The second harmonic of 434MHz (868MHz) falls within the strict Out Of Band (OOB) power limit of -36dBm. In this case an addition low-pass filter (LPF) may be beneficial to the radio designer. In combination with the high-power match at 434MHz noted above, the following LPF has shown compliant operational results.

Table A2-2. External LPF Component Values

EXTERNAL PART	QTY	DESCRIPTION
C1-C2	2	7.5pF ± 0.25pF Capacitor (0402) muRata GRM1555C1H7R5FZ01
L1, L3	2	19nH ± 5% Inductor (0402) Coilcraft 0402CS-19NXJB
L2	1	36nH ± 5% Inductor (0402) Coilcraft 0402CS-19NXJB

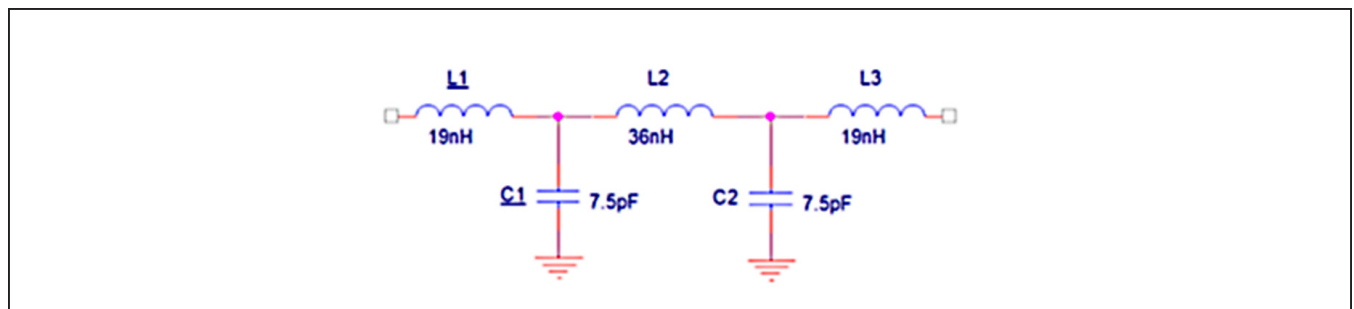

Figure A2-3. External Filter

PA Boost Mode Network Design

The switch-mode PA architecture inherently deals with voltage levels which are higher than the VDD supply. When operating the PA in Boost Mode, even higher voltages can be presented to the PA node. If the user wishes to experiment with additional boost capabilities, the MAX4146x EV kit has a separate output network that allows the user to limit the PA voltage swing.

The optional R18/L1B network can be used to reduce the voltage swing at the PA node by inserting a resistor in series with the PA bias inductor. It is recommended that C9 and C10 be populated as shown, this helps ‘fix’ the sub-VDD supply below the supply voltage.

For additional information on switch-mode PAs similar to the one used in this transmitter, see *Application Note 3589–Power Amplifier Theory for High-Efficiency Low-Cost ISM-Band Transmitters*.

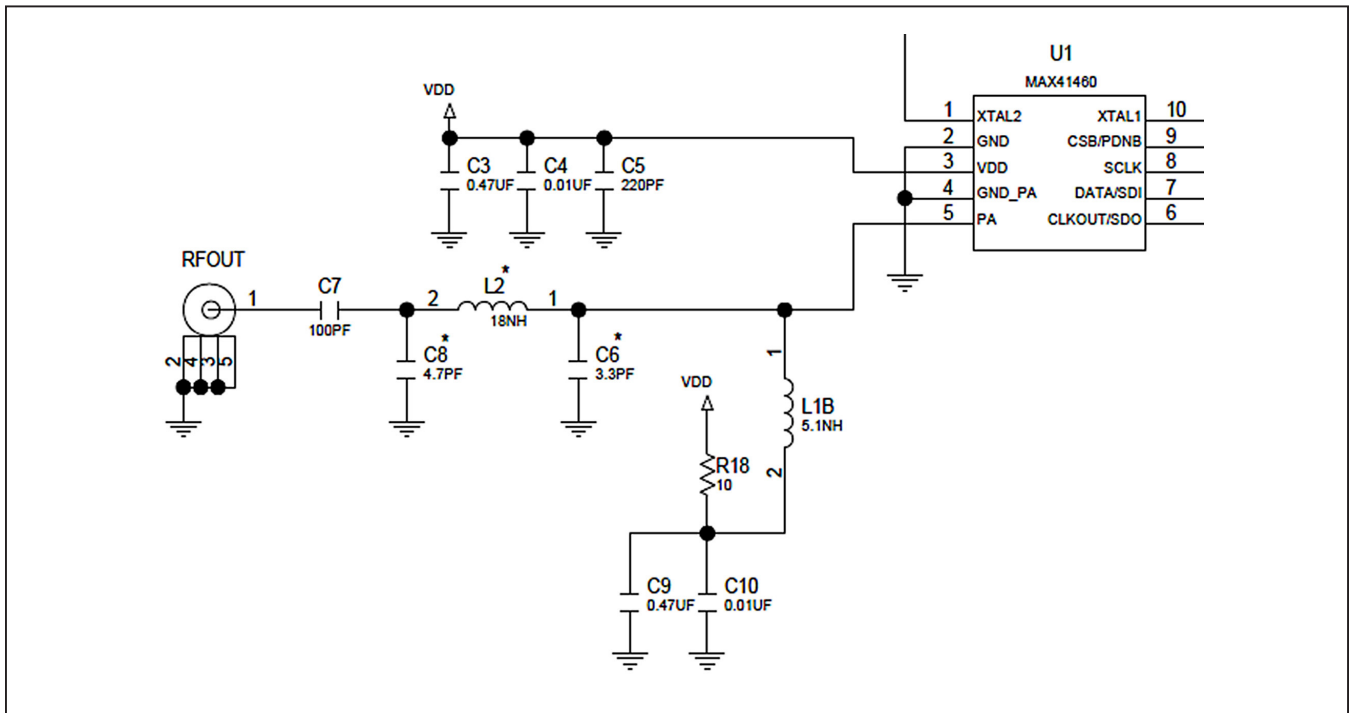

Figure A2-4. Matching Network

Pmod Header Interface

The MAX4146x EV kit provides a Pmod-compatible header footprint providing yet another built-in interface to the transmitter. The JU4 connector can be populated with a 6-pin, 100mil, right-angle header such as a SAMTEC TSW-106-25-T-S-RA, allowing direct connections to the CSB, DATAIN, CLKOUT, SCLK/SDA, Ground, and VDD lines.

The Pmod interface can be used in combination with the Maxim MAX32600MBED kit and the MAXREFDES72# Arduino Uno R3 to PMOD shield adaptor. When using the Pmod interface to supply the MAX4146X EV kit with power, make sure to connect the JU1 jumper between pins 2-3.

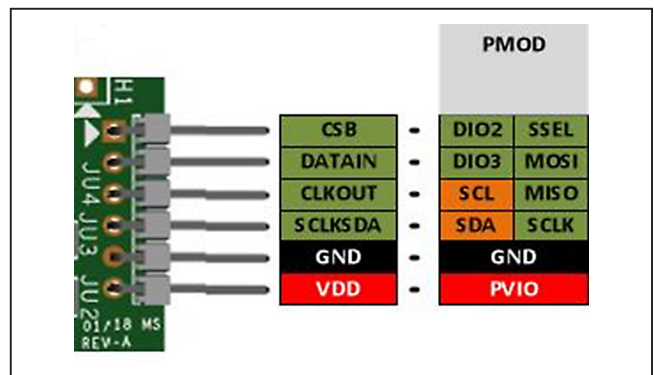

Figure A2-5. MAX4146x EV kit Pmod Interface

MAX4146x Evaluation Kit

Evaluates: MAX41460
MAX41463
MAX41464

MAX41460
ASK/FSK Transmitter with SPI Interface

MAX41461/62
ASK Transmitter with preset and I²C Interface

MAX41463/64
FSK Transmitter with preset and I²C Interface

POWER SUPPLY SELECTION (JU1)
1-2 Power from FTNR Board
2-3 Power from PMOD Interface

VDD
External Power Supply Input

DATAIN
MAX41460 DATA/SDI
- DATA INPUT
- SPI Serial Data Input
MAX41461-64 DATA/SDA
- Preset Mode (DATA)
Single Pin Data Interface
- I²C Mode (SDA)
I²C Serial Data Input

PRESET FREQUENCY SELECTION
MAX41460
- No Preset Frequency selection option. Programmable via SPI
MAX41461-64
- I²C Programming Mode
SELO=GND and SEL1=GND
- Preset Mode
Refer QSG Document for different preset frequency states

CLKOUT
MAX41460 CLKOUT/SDO
- Three Wire SPI Enabled (CLKOUT)
Buffered Clock Output
- Four-wire SPI Enabled (SDO)
SPI Data Output
MAX41461-64 CLKOUT/SCL
- Preset Mode (CLKOUT)
Buffered Clock Output
- I²C Mode (SCL)
Clock for I²C Interface

MAX4146x
10-PIN TSSOP PACKAGE

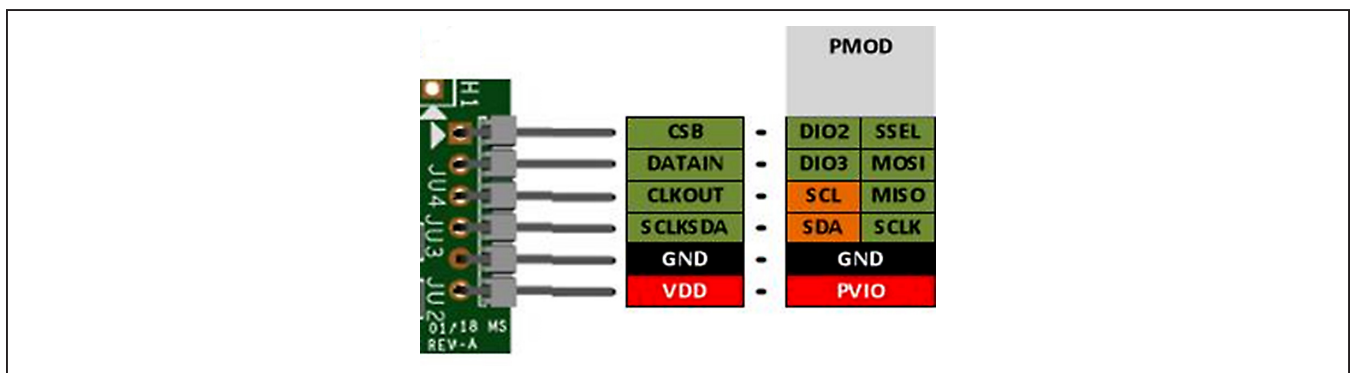

MAX4146x Evaluation Kit

Evaluates: MAX41460
MAX41463
MAX41464

MAX32630FTHR

ARM Cortex-M4F microcontroller rapid development platform.

