

MAXIM

Ultra-Small, Low-Cost, 210MHz, Single-Supply Op Amps with Rail-to-Rail Outputs and Disable

General Description

The MAX4380–MAX4384 family of op amps are unity-gain-stable devices that combine high-speed performance, Rail-to-Rail® outputs, and high-impedance disable mode. These devices operate from a +4.5V to +11V single supply or from $\pm 2.25V$ to $\pm 5.5V$ dual supplies. The common-mode input voltage range extends beyond the negative power-supply rail (ground in single-supply applications).

The MAX4380–MAX4384 require only 5.5mA of quiescent supply current per op amp while achieving a 210MHz -3dB bandwidth, 55MHz 0.1dB gain flatness and a 485V/ μ s slew rate. These devices are an excellent solution in low-power/low-voltage systems that require wide bandwidth, such as video, communications, and instrumentation.

The MAX4380 single with disable is available in an ultra-small 6-pin SC70 package.

Applications

Set-Top Boxes
Surveillance Video Systems
Battery-Powered Instruments
Analog-to-Digital Converter Interface
CCD Imaging Systems
Video Routing and Switching Systems
Digital Cameras
Video-on-Demand
Video Line Driver

Typical Operating Circuit

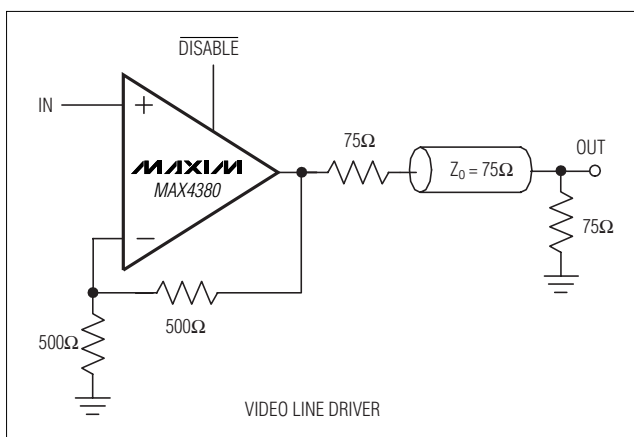

Rail-to-Rail is a registered trademark of Nippon Motorola, Ltd.

MAXIM

Features

- ◆ Low Cost and High Speed:
 - 210MHz -3dB Bandwidth
 - 55MHz 0.1dB Gain Flatness
 - 485V/ μ s Slew Rate
- ◆ Disable Mode Places Outputs in High-Impedance State
- ◆ Single +4.5V to +11V Operation
- ◆ Rail-to-Rail Outputs
- ◆ Input Common-Mode Range Extends Beyond V_{EE}
- ◆ Low Differential Gain/Phase: 0.02%/0.08°
- ◆ Low Distortion at 5MHz
 - 65dBc SFDR
 - 63dB Total Harmonic Distortion
- ◆ Ultra-Small 6-Pin SC70, 6-Pin SOT23, 10-Pin μ MAX, 14-Pin TSSOP, and 20-Pin TSSOP Packages

Ordering Information

| PART | TEMP RANGE | PIN-PACKAGE | TOP MARK |
|--------------|----------------|--------------|----------|
| MAX4380EXT-T | -40°C to +85°C | 6 SC70-6 | AAV |
| MAX4380EUT-T | -40°C to +85°C | 6 SOT23-6 | — |
| MAX4381EUB | -40°C to +85°C | 10 μ MAX | — |
| MAX4382EUD | -40°C to +85°C | 14 TSSOP | — |
| MAX4382ESD | -40°C to +85°C | 14 SO | — |
| MAX4382EEE | -40°C to +85°C | 16 QSOP | — |
| MAX4383EUD | -40°C to +85°C | 14 TSSOP | — |
| MAX4383ESD | -40°C to +85°C | 14 SO | — |
| MAX4383ESE | -40°C to +85°C | 16 SO | — |
| MAX4383EEE | -40°C to +85°C | 16 QSOP | — |
| MAX4384EUP | -40°C to +85°C | 20 TSSOP | — |

Pin Configurations

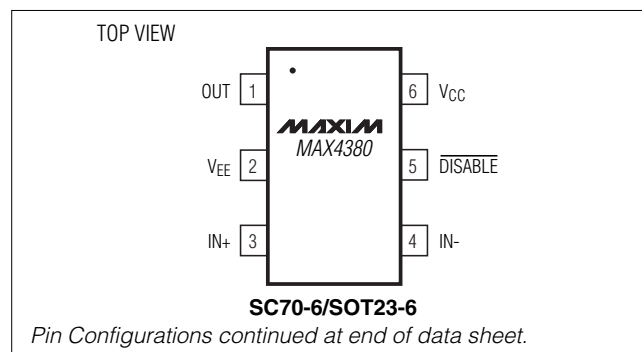

Maxim Integrated Products 1

For pricing, delivery, and ordering information, please contact Maxim/Dallas Direct! at 1-888-629-4642, or visit Maxim's website at www.maxim-ic.com.

MAX4380-MAX4384

Ultra-Small, Low-Cost, 210MHz, Single-Supply Op Amps with Rail-to-Rail Outputs and Disable

ABSOLUTE MAXIMUM RATINGS

| | | | |
|--|--|---|-----------------|
| Supply Voltage (V_{CC} to V_{EE})..... | +12V | 14-Pin SO (derate 8.3mW/°C above +70°C)..... | 667mW |
| IN_- , IN_+ , OUT_- , $DISABLE_-$ | ($V_{EE} - 0.3V$) to ($V_{CC} + 0.3V$) | 16-Pin QSOP (derate 8.3mW/°C above +70°C)..... | 667mW |
| Output Short-Circuit to V_{CC} or V_{EE} | 1s | 16-Pin Narrow SO (derate 8.7mW/°C above +70°C)..... | 696mW |
| Continuous Power Dissipation ($T_A = +70^\circ C$) | | 20-Pin TSSOP (derate 10.9mW/°C above +70°C)..... | 879mW |
| 6-Pin SC70 (derate 3.1mW/°C above +70°C)..... | 245mW | Operating Temperature Range..... | -40°C to +85°C |
| 6-Pin SOT23 (derate 7.1mW/°C above +70°C)..... | 571mW | Junction Temperature..... | +150°C |
| 10-Pin μ MAX (derate 5.6mW/°C above +70°C)..... | 444mW | Storage Temperature Range..... | -65°C to +150°C |
| 14-Pin TSSOP (derate 9.1mW/°C above +70°C)..... | 727mW | Lead Temperature (soldering, 10s)..... | +300°C |

Stresses beyond those listed under "Absolute Maximum Ratings" may cause permanent damage to the device. These are stress ratings only, and functional operation of the device at these or at any other conditions beyond those indicated in the operational sections of the specifications is not implied. Exposure to absolute maximum rating conditions for extended periods may affect device reliability.

DC ELECTRICAL CHARACTERISTICS—Single Supply

($V_{CC} = +5V$, $V_{EE} = 0$, $V_{CM} = V_{CC}/2$, $V_{OUT} = V_{CC}/2$, $R_L = \infty$ to $V_{CC}/2$, $DISABLE_- = V_{CC}$ (MAX4380/MAX4381/MAX4382/MAX4384), $T_A = T_{MIN}$ to T_{MAX} , unless otherwise noted. Typical values are at $T_A = +25^\circ C$.) (Note 1)

| PARAMETER | SYMBOL | CONDITIONS | MIN | TYP | MAX | UNITS |
|---------------------------------|-------------------|--|-------------------|-----------|-----------------|------------------|
| Input Common-Mode Voltage Range | V_{CM} | Guaranteed by CMRR | $V_{EE} - 0.2$ | | $V_{CC} - 2.25$ | V |
| Input Offset Voltage | V_{OS} | $T_A = +25^\circ C$ | | 0.2 | 12 | mV |
| | | $T_A = -40^\circ C$ to $+85^\circ C$ | | | 20 | |
| Input Offset Voltage Matching | | MAX4381-MAX4384 | | 1 | | mV |
| Input Offset Voltage Tempco | TC_{VOS} | | | 8 | | $\mu V/^\circ C$ |
| Input Bias Current | I_B | | | 6.5 | 20 | μA |
| Input Offset Current | I_{OS} | | | 0.5 | 7 | μA |
| Input Resistance | R_{IN} | Differential mode ($-1V \leq V_{IN} \leq +1V$) | | 70 | | k Ω |
| | | Common mode ($-0.2V \leq V_{CM} \leq +2.75V$) | | 3 | | M Ω |
| Common-Mode Rejection Ratio | CMRR | $V_{EE} - 0.2V \leq V_{CM} \leq V_{CC} - 2.25V$ | 70 | 95 | | dB |
| Open-Loop Gain | A_{VOL} | $0.25V \leq V_{OUT} \leq 4.75V$, $R_L = 2k\Omega$ | 50 | 61 | | dB |
| | | $0.8V \leq V_{OUT} \leq 4.5V$, $R_L = 150\Omega$ | 48 | 63 | | |
| | | $1V \leq V_{OUT} \leq 4V$, $R_L = 50\Omega$ | | 58 | | |
| Output Voltage Swing | V_{OUT} | $R_L = 2k\Omega$ | $V_{CC} - V_{OH}$ | 0.05 | 0.2 | V |
| | | | $V_{OL} - V_{EE}$ | 0.05 | 0.15 | |
| | | $R_L = 150\Omega$ | $V_{CC} - V_{OH}$ | 0.3 | 0.5 | |
| | | | $V_{OL} - V_{EE}$ | 0.25 | 0.8 | |
| | | $R_L = 75\Omega$ | $V_{CC} - V_{OH}$ | 0.5 | 0.8 | |
| | | | $V_{OL} - V_{EE}$ | 0.5 | 1.75 | |
| $R_L = 75\Omega$ to ground | $V_{CC} - V_{OH}$ | 1 | 1.7 | | | |
| | $V_{OL} - V_{EE}$ | 0.025 | 0.125 | | | |
| Output Current | I_{OUT} | Sinking from $R_L = 75\Omega$ to V_{CC} | 40 | 55 | | mA |
| | | Sourcing into $R_L = 75\Omega$ to V_{EE} | 25 | 50 | | |
| Output Short-Circuit Current | I_{SC} | Sinking or sourcing | | ± 100 | | mA |
| Open-Loop Output Resistance | R_{OUT} | | | 8 | | Ω |
| Power-Supply Rejection Ratio | PSRR | $V_S = +4.5V$ to $+5.5V$ | 50 | 62 | | dB |

Ultra-Small, Low-Cost, 210MHz, Single-Supply Op Amps with Rail-to-Rail Outputs and Disable

MAX4380-MAX4384

DC ELECTRICAL CHARACTERISTICS—Single Supply

($V_{CC} = +5V$, $V_{EE} = 0$, $V_{CM} = V_{CC}/2$, $V_{OUT} = V_{CC}/2$, $R_L = \infty$ to $V_{CC}/2$, $\overline{DISABLE}_- = V_{CC}$ (MAX4380/MAX4381/MAX4382/MAX4384), $T_A = T_{MIN}$ to T_{MAX} , unless otherwise noted. Typical values are at $T_A = +25^\circ C$.) (Note 1)

| PARAMETER | SYMBOL | CONDITIONS | MIN | TYP | MAX | UNITS |
|---|----------------|---|-----------------|------|--------------|-----------|
| Operating Supply Voltage Range | V_S | Guaranteed by PSRR (Note 2) | 4.5 | | 11 | V |
| Disabled Output Resistance | $R_{OUT(OFF)}$ | $\overline{DISABLE}_- = 0$, $0 \leq V_{OUT} \leq 5V$ | 27 | 35 | | $k\Omega$ |
| $\overline{DISABLE}_-$ Logic-Low Threshold | V_{IL} | | | | $V_{CC} - 3$ | V |
| $\overline{DISABLE}_-$ Logic-High Threshold | V_{IH} | | $V_{CC} - 1.25$ | | | V |
| $\overline{DISABLE}_-$ Logic Input Low Current | I_{IL} | $\overline{DISABLE}_- = 0$ | | 25 | 60 | μA |
| $\overline{DISABLE}_-$ Logic Input High Current | I_{IH} | $\overline{DISABLE}_- = V_{CC}$ | | 10 | 40 | μA |
| Quiescent Supply Current (Per Amplifier) | I_S | $\overline{DISABLE}_- = V_{CC}$ | | 5.5 | 9 | mA |
| | | $\overline{DISABLE}_- = 0$ | | 0.45 | 0.6 | |

DC ELECTRICAL CHARACTERISTICS—Dual Supply

($V_{CC} = +5V$, $V_{EE} = -5V$, $V_{CM} = 0$, $V_{OUT} = 0$, $R_L = \infty$ to 0, $\overline{DISABLE}_- = V_{CC}$ (MAX4380/MAX4381/MAX4382/MAX4384), $T_A = T_{MIN}$ to T_{MAX} , unless otherwise noted. Typical values are at $T_A = +25^\circ C$.) (Note 1)

| PARAMETER | SYMBOL | CONDITIONS | MIN | TYP | MAX | UNITS |
|---------------------------------|------------|---|-------------------|-------|-----------------|------------------|
| Input Common-Mode Voltage Range | V_{CM} | Guaranteed by CMRR | V_{EE} | | $V_{CC} - 2.25$ | V |
| Input Offset Voltage | V_{OS} | $T_A = +25^\circ C$ | | 3 | 16 | mV |
| | | $T_A = T_{MIN}$ to T_{MAX} | | | 24 | |
| Input Offset Voltage Matching | | MAX4381-MAX4384 | | 1 | | mV |
| Input Offset Voltage Tempco | TC_{VOS} | | | 8 | | $\mu V/^\circ C$ |
| Input Bias Current | I_B | | | 8.5 | 25 | μA |
| Input Offset Current | I_{OS} | | | 0.5 | 12 | μA |
| Input Resistance | R_{IN} | Differential mode ($-1V \leq V_{IN} \leq +1V$) | | 70 | | $k\Omega$ |
| | | Common mode ($-5V \leq V_{CM} \leq 2.75V$) | | 3 | | $M\Omega$ |
| Common-Mode Rejection Ratio | CMRR | $V_{EE} \leq V_{CM} \leq V_{CC} - 2.25V$ | 70 | 95 | | dB |
| Open-Loop Gain | A_{VOL} | $-4.5V \leq V_{OUT} \leq +4.5V$, $R_L = 2k\Omega$ | 50 | 62 | | dB |
| | | $-4.25V \leq V_{OUT} \leq +4.25V$, $R_L = 150\Omega$ | 48 | 65 | | |
| | | $-4V \leq V_{OUT} \leq +4V$, $R_L = 50\Omega$ | | 60 | | |
| Output Voltage Swing | V_{OUT} | $R_L = 2k\Omega$ | $V_{CC} - V_{OH}$ | 0.175 | 0.375 | V |
| | | | $V_{OL} - V_{EE}$ | 0.075 | 0.225 | |
| | | $R_L = 150\Omega$ | $V_{CC} - V_{OH}$ | 0.575 | 0.85 | |
| | | | $V_{OL} - V_{EE}$ | 0.4 | 0.775 | |
| | | $R_L = 75\Omega$ | $V_{CC} - V_{OH}$ | 1.3 | 2.3 | |
| | | | $V_{OL} - V_{EE}$ | 1.3 | 2.45 | |

Ultra-Small, Low-Cost, 210MHz, Single-Supply Op Amps with Rail-to-Rail Outputs and Disable

DC ELECTRICAL CHARACTERISTICS—Dual Supply (continued)

($V_{CC} = +5V$, $V_{EE} = -5V$, $V_{CM} = 0$, $V_{OUT} = 0$, $R_L = \infty$ to 0 , $\overline{DISABLE}_- = V_{CC}$ (MAX4380/MAX4381/MAX4382/MAX4384), $T_A = T_{MIN}$ to T_{MAX} , unless otherwise noted. Typical values are at $T_A = +25^\circ C$.) (Note 1)

| PARAMETER | SYMBOL | CONDITIONS | MIN | TYP | MAX | UNITS |
|---|----------------|---|-----------------|-----------|--------------|------------|
| Output Current | I_{OUT} | Sinking from $R_L = 75\Omega$ to V_{CC} | 50 | 75 | | mA |
| | | Sourcing into $R_L = 75\Omega$ to V_{EE} | 50 | 75 | | |
| Output Short-Circuit Current | I_{SC} | Sinking or sourcing | | ± 100 | | mA |
| Open-Loop Output Resistance | R_{OUT} | | | 8 | | Ω |
| Power-Supply Rejection Ratio | PSRR | $V_S = \pm 4.5V$ to $\pm 5.5V$ | 48 | 62 | | dB |
| Operating Supply Voltage Range | V_S | Guaranteed by PSRR (Note 2) | ± 2.25 | | ± 5.5 | V |
| Disabled Output Resistance | $R_{OUT(OFF)}$ | $\overline{DISABLE}_- = 0$, $-5V \leq V_{OUT} \leq 5V$ | 27 | 35 | | k Ω |
| $\overline{DISABLE}_-$ Logic-Low Threshold | V_{IL} | | | | $V_{CC} - 3$ | V |
| $\overline{DISABLE}_-$ Logic-High Threshold | V_{IH} | | $V_{CC} - 1.25$ | | | V |
| $\overline{DISABLE}_-$ Logic Input Low Current | I_{IL} | $\overline{DISABLE}_- = 0$ | | 25 | | μA |
| $\overline{DISABLE}_-$ Logic Input High Current | I_{IH} | $\overline{DISABLE}_- = V_{CC}$ | | 10 | | μA |
| Quiescent Supply Current (Per Amplifier) | I_S | $\overline{DISABLE}_- = V_{CC}$ | | 7.5 | 10 | mA |
| | | $\overline{DISABLE}_- = 0$ | | 0.45 | 0.8 | |

AC ELECTRICAL CHARACTERISTICS—Single Supply

($V_{CC} = +5V$, $V_{EE} = 0$, $V_{CM} = +1.5V$, $R_L = 100\Omega$ to $V_{CC}/2$, $\overline{DISABLE}_- = V_{CC}$ (MAX4380/MAX4381/MAX4382/MAX4384), $V_{OUT} = V_{CC}/2$, $A_{VCL} = +1V/V$, $T_A = +25^\circ C$, unless otherwise noted.)

| PARAMETER | SYMBOL | CONDITIONS | MIN | TYP | MAX | UNITS |
|--|----------------|--|----------------|-----|-----|------------|
| Small-Signal -3dB Bandwidth | BW_{SS} | $V_{OUT} = 100mVp-p$ | | 210 | | MHz |
| Large-Signal -3dB Bandwidth | BW_{LS} | $V_{OUT} = 2Vp-p$ | | 175 | | MHz |
| Small-Signal 0.1dB Gain Flatness | $BW_{0.1dBSS}$ | $V_{OUT} = 100mVp-p$ | | 55 | | MHz |
| Large-Signal 0.1dB Gain Flatness | $BW_{0.1dBLS}$ | $V_{OUT} = 2Vp-p$ | | 40 | | MHz |
| Slew Rate | SR | $V_{OUT} = 2V$ step | | 485 | | V/ μs |
| Settling Time to 0.1% | t_S | $V_{OUT} = 2V$ step | | 16 | | ns |
| Rise/Fall Time | t_R, t_F | $V_{OUT} = 100mVp-p$ | | 4 | | ns |
| Spurious-Free Dynamic Range | SFDR | $f_C = 5MHz$, $V_{OUT} = 2Vp-p$ | | -65 | | dBc |
| Harmonic Distortion | HD | $f_C = 5MHz$, $V_{OUT} = 2Vp-p$ | 2nd harmonic | -65 | | dBc |
| | | | 3rd harmonic | -68 | | |
| | | | Total harmonic | -63 | | |
| Two-Tone, Third-Order Intermodulation Distortion | IP3 | $f_1 = 4.7MHz$, $f_2 = 4.8MHz$, $V_{OUT} = 1Vp-p$ | | -66 | | dBc |

Ultra-Small, Low-Cost, 210MHz, Single-Supply Op Amps with Rail-to-Rail Outputs and Disable

MAX4380-MAX4384

AC ELECTRICAL CHARACTERISTICS—Single Supply (continued)

($V_{CC} = +5V$, $V_{EE} = 0$, $V_{CM} = +1.5V$, $R_L = 100\Omega$ to $V_{CC}/2$, $\overline{DISABLE}_- = V_{CC}$ (MAX4380/MAX4381/MAX4382/MAX4384), $V_{OUT} = V_{CC}/2$, $A_{VCL} = +1V/V$, $T_A = +25^\circ C$, unless otherwise noted.)

| PARAMETER | SYMBOL | CONDITIONS | MIN | TYP | MAX | UNITS |
|------------------------------|-------------------|---|-----|------|-----|-----------------|
| Channel-to-Channel Isolation | CH _{ISO} | Specified at DC | | -102 | | dB |
| Input 1dB Compression Point | | $f_C = 10MHz$, $A_{VCL} = +2V/V$ | | 14 | | dBm |
| Differential Phase Error | DP | NTSC, $R_L = 150\Omega$ | | 0.08 | | degrees |
| Differential Gain Error | DG | NTSC, $R_L = 150\Omega$ | | 0.02 | | % |
| Input Noise-Voltage Density | e_n | $f = 10kHz$ | | 10 | | nV/ \sqrt{Hz} |
| Input Noise-Current Density | i_n | $f = 10kHz$ | | 2 | | pA/ \sqrt{Hz} |
| Input Capacitance | C_{IN} | | | 1 | | pF |
| Output Impedance | Z_{OUT} | $f = 10MHz$ | | 1.5 | | Ω |
| Enable Time | t_{ON} | $V_{IN} = 1V$ (MAX4380/MAX4381/MAX4382/MAX4384) | | 100 | | ns |
| Disable Time | t_{OFF} | $V_{IN} = 1V$ (MAX4380/MAX4381/MAX4382/MAX4384) | | 1 | | μs |

Note 1: All devices are 100% production tested at $T_A = +25^\circ C$. Specifications over temperature limits are guaranteed by design.

Note 2: PSRR for single +5V supply tested with $V_{EE} = 0$, $V_{CC} = +4.5V$ to $+5.5V$; PSRR for dual $\pm 5V$ supply tested with $V_{EE} = -4.5V$ to $-5.5V$, $V_{CC} = +4.5V$ to $+5.5V$.

Typical Operating Characteristics

($V_{CC} = +5V$, $V_{EE} = 0$, $V_{CM} = +1.5V$, $A_{VCL} = +1V/V$, $R_L = 100\Omega$ to $V_{CC}/2$, $T_A = +25^\circ C$, unless otherwise noted.)

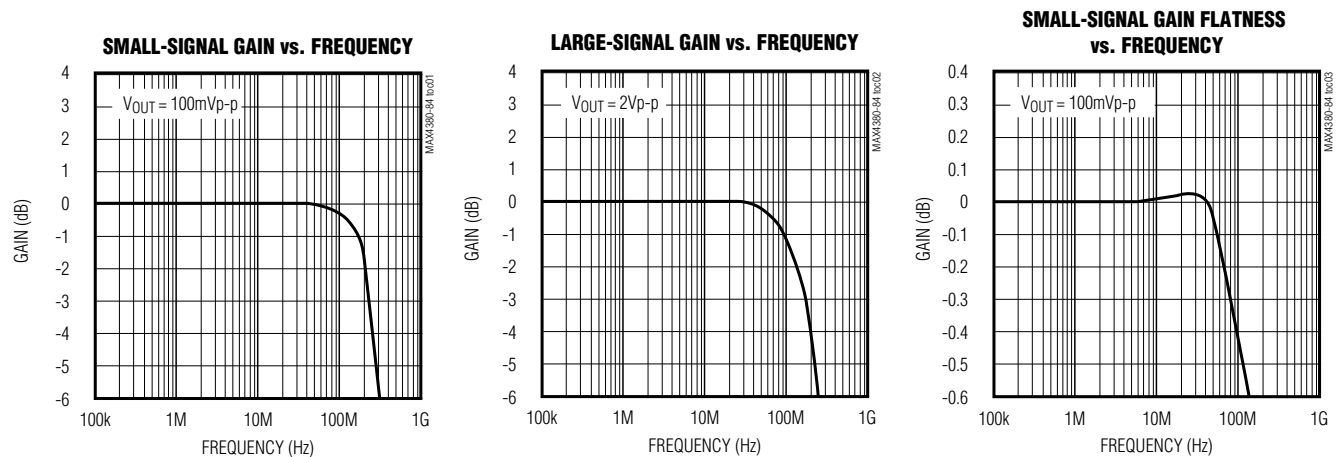

Ultra-Small, Low-Cost, 210MHz, Single-Supply Op Amps with Rail-to-Rail Outputs and Disable

Typical Operating Characteristics (continued)

($V_{CC} = +5V$, $V_{EE} = 0$, $V_{CM} = +1.5V$, $A_{VCL} = +1$, $R_L = 100\Omega$ to $V_{CC}/2$, $T_A = +25^\circ C$, unless otherwise noted.)

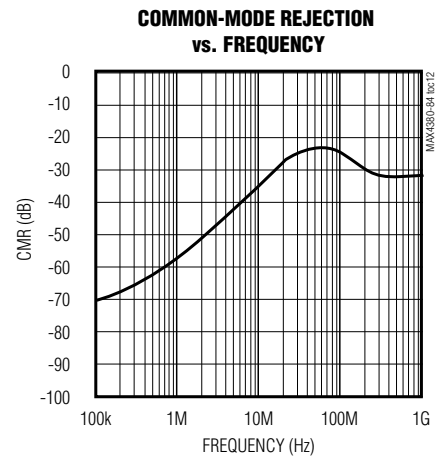
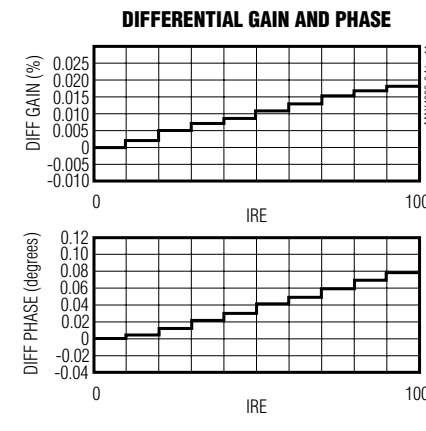
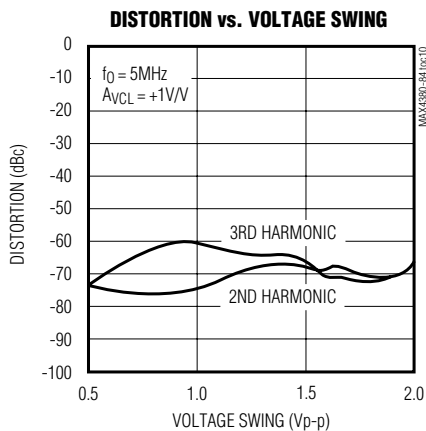
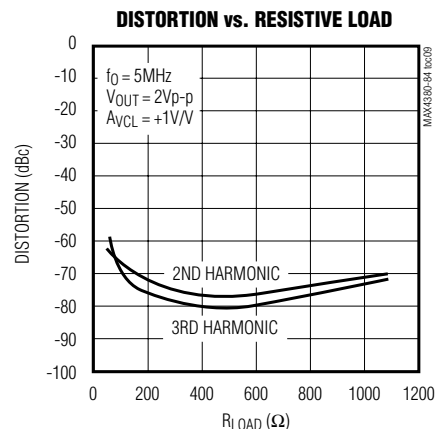
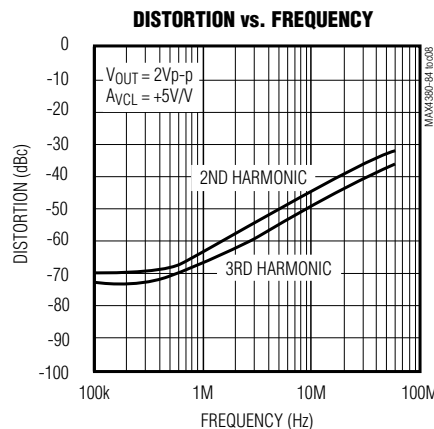
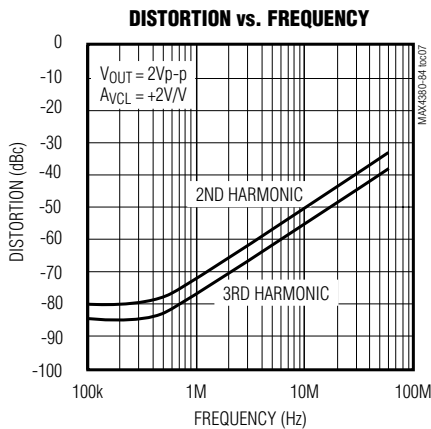
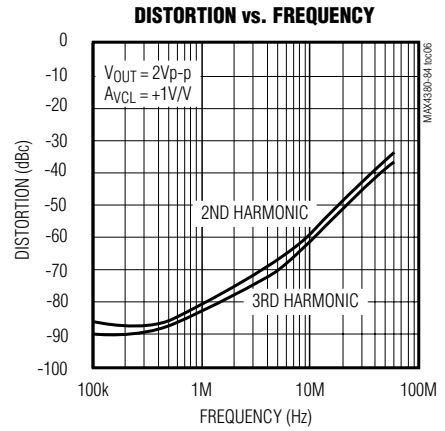
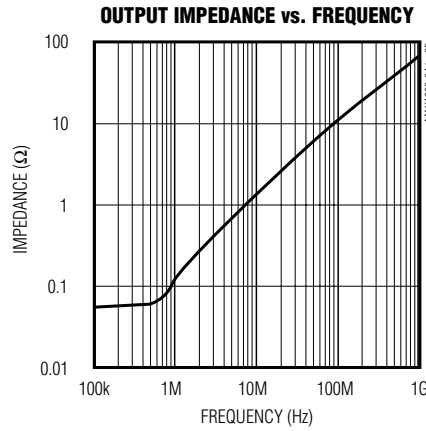
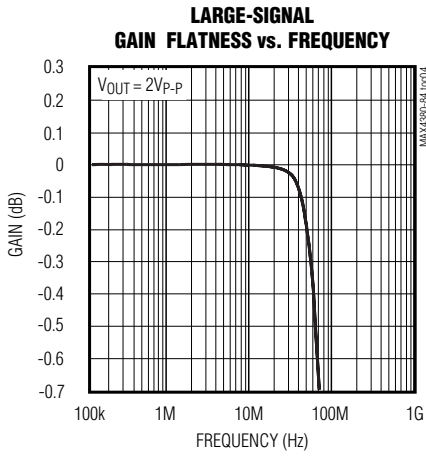

Ultra-Small, Low-Cost, 200MHz, Single-Supply Op Amps with Rail-to-Rail Outputs and Disable

Typical Operating Characteristics (continued)

($V_{CC} = +5V$, $V_{EE} = 0$, $V_{CM} = +1.5V$, $A_{VCL} = +1$, $R_L = 100\Omega$ to $V_{CC}/2$, $T_A = +25^\circ C$, unless otherwise noted.)

MAX4380-MAX4384

POWER-SUPPLY REJECTION vs. FREQUENCY

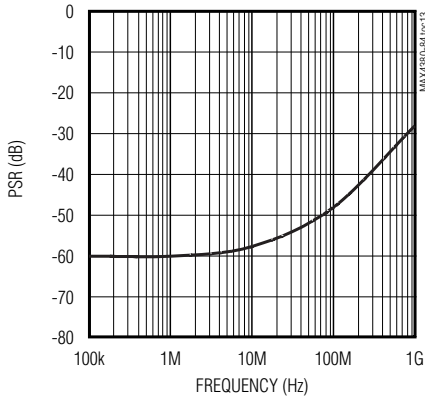

OUTPUT VOLTAGE SWING vs. RESISTIVE LOAD

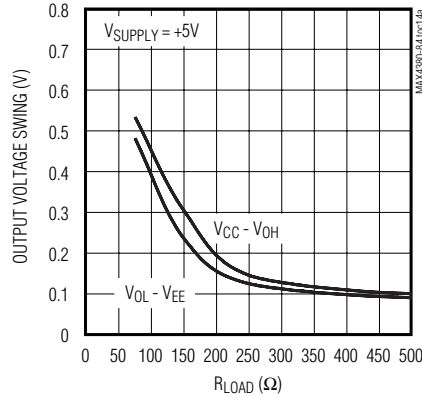

OUTPUT VOLTAGE SWING vs. RESISTIVE LOAD

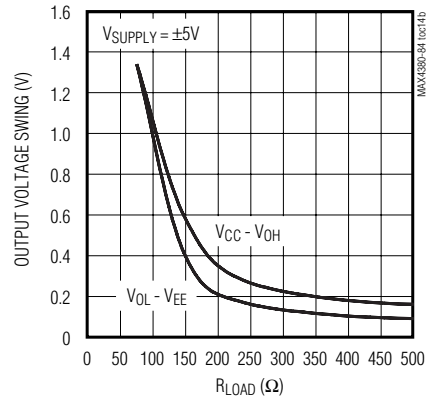

SMALL-SIGNAL PULSE RESPONSE

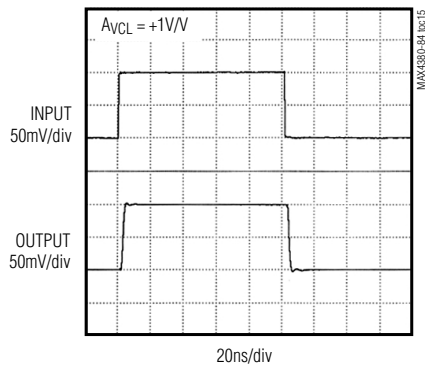

SMALL-SIGNAL PULSE RESPONSE

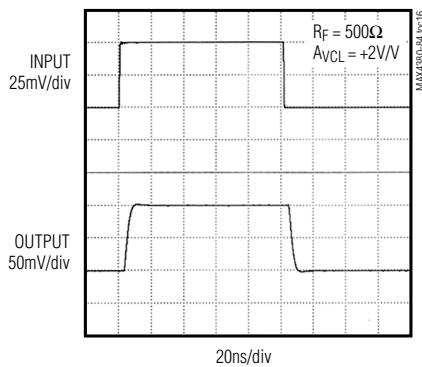

SMALL-SIGNAL PULSE RESPONSE

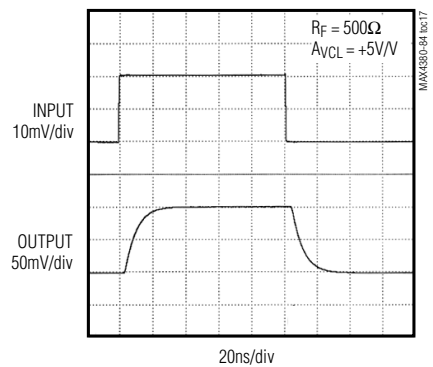

LARGE-SIGNAL PULSE RESPONSE

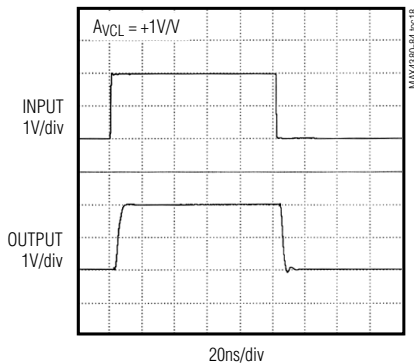

LARGE-SIGNAL PULSE RESPONSE

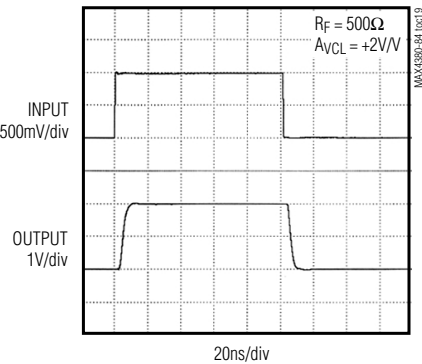

LARGE-SIGNAL PULSE RESPONSE

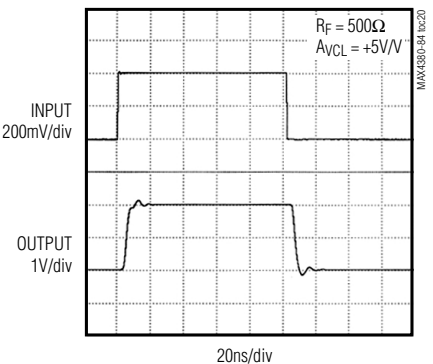

Ultra-Small, Low-Cost, 210MHz, Single-Supply Op Amps with Rail-to-Rail Outputs and Disable

Typical Operating Characteristics (continued)

($V_{CC} = +5V$, $V_{EE} = 0$, $V_{CM} = +1.5V$, $A_{VCL} = +1$, $R_L = 100\Omega$ to $V_{CC}/2$, $T_A = +25^\circ C$, unless otherwise noted.)

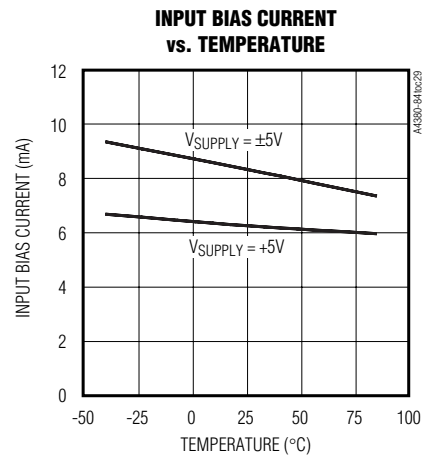
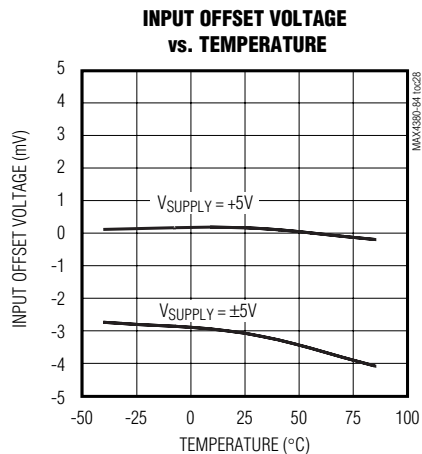
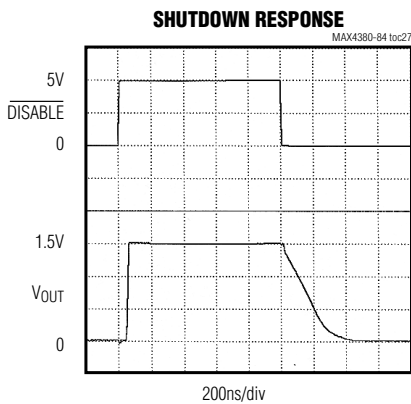
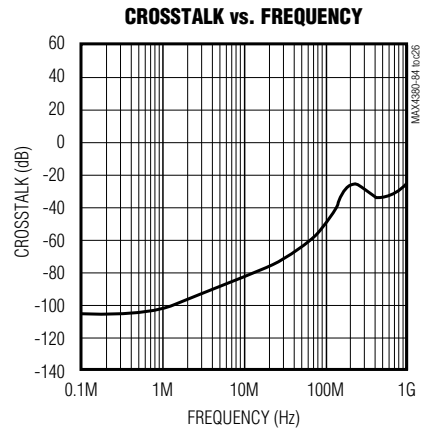
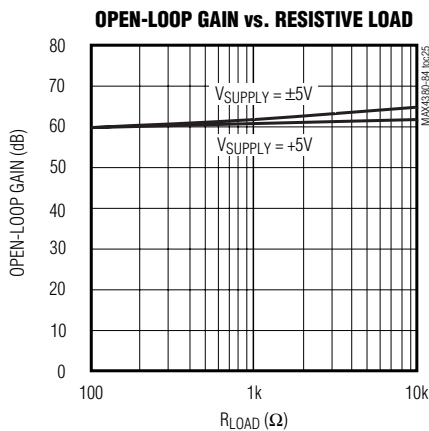
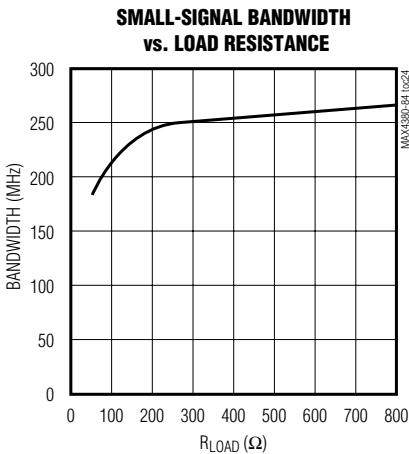
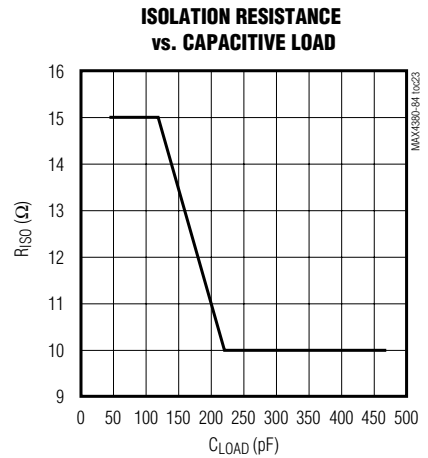
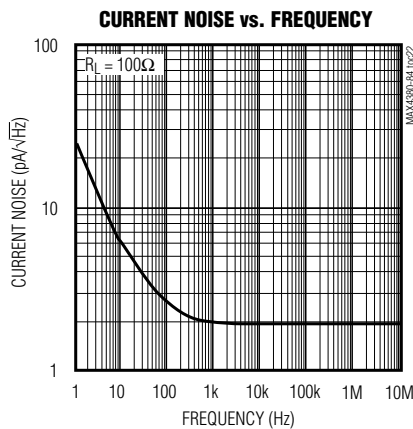
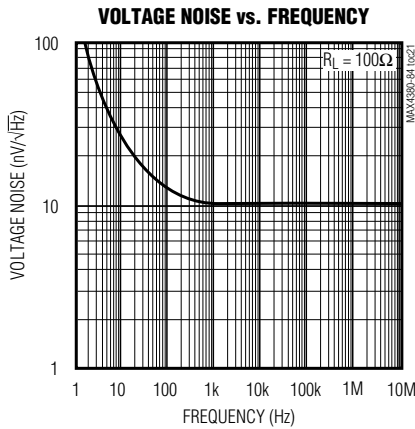

Ultra-Small, Low-Cost, 210MHz, Single-Supply Op Amps with Rail-to-Rail Outputs and Disable

MAX4380-MAX4384

Typical Operating Characteristics (continued)

($V_{CC} = +5V$, $V_{EE} = 0$, $V_{CM} = +1.5V$, $A_{VCL} = +1$, $R_L = 100\Omega$ to $V_{CC}/2$, $T_A = +25^\circ C$, unless otherwise noted.)

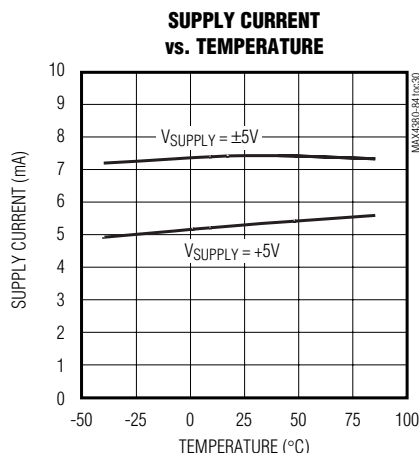

Pin Description

| PIN | | | | | | | NAME | FUNCTION |
|------------|-----------|---------|----------|----------|---------|---------|-----------------------|--|
| MAX4380 | MAX4381 | MAX4382 | | MAX4383 | | MAX4384 | | |
| SC70/SOT23 | μ MAX | QSOP | SO/TSSOP | SO/TSSOP | SO/QSOP | TSSOP | | |
| 6 | 10 | 4 | 4 | 4 | 4 | 5 | V_{CC} | Positive Power Supply. Connect a 0.1 μ F capacitor to GND. |
| 2 | 4 | 13 | 11 | 11 | 13 | 16 | V_{EE} | Negative Power Supply. Connect a 0.1 μ F Capacitor to GND. |
| 3 | — | — | — | — | — | — | IN+ | Noninverting Input |
| 4 | — | — | — | — | — | — | IN- | Inverting Input |
| 1 | — | — | — | — | — | — | OUT | Amplifier Output |
| 5 | — | — | — | — | — | — | $\overline{DISABLE}$ | Disable. Connect to V_{CC} to Enable. |
| — | 3 | 5 | 5 | 3 | 3 | 4 | INA+ | Amplifier A Noninverting Input |
| — | 2 | 6 | 6 | 2 | 2 | 3 | INA- | Amplifier A Inverting Input |
| — | 1 | 7 | 7 | 1 | 1 | 2 | OUTA | Amplifier A Output |
| — | 5 | 1 | 1 | — | — | 1 | $\overline{DISABLEA}$ | Shutdown Amplifier A. Connect to V_{CC} to Enable. |
| — | 7 | 12 | 10 | 5 | 5 | 6 | INB+ | Amplifier B Noninverting Input |

Ultra-Small, Low-Cost, 210MHz, Single-Supply Op Amps with Rail-to-Rail Outputs and Disable

Pin Description (continued)

| PIN | | | | | | | NAME | FUNCTION |
|------------|---------|---------|----------|----------|---------|---------|------------------------------|---|
| MAX4380 | MAX4381 | MAX4382 | | MAX4383 | | MAX4384 | | |
| SC70/SOT23 | μMAX | QSOP | SO/TSSOP | SO/TSSOP | SO/QSOP | TSSOP | | |
| — | 8 | 11 | 9 | 6 | 6 | 7 | INB- | Amplifier B Inverting Input |
| — | 9 | 10 | 8 | 7 | 7 | 8 | OUTB | Amplifier B Output |
| — | 6 | 3 | 3 | — | — | 9 | $\overline{\text{DISABLEB}}$ | Shutdown Amplifier B. Connect to V _{CC} to Enable. |
| — | — | 14 | 12 | 10 | 12 | 15 | INC+ | Amplifier C Noninverting Input |
| — | — | 15 | 13 | 9 | 11 | 14 | INC- | Amplifier C Inverting Input |
| — | — | 16 | 14 | 8 | 10 | 13 | OUTC | Amplifier C Output |
| — | — | 2 | 2 | — | — | 12 | $\overline{\text{DISABLEC}}$ | Shutdown Amplifier C. Connect to V _{CC} to Enable. |
| — | — | — | — | 12 | 14 | 17 | IND+ | Amplifier D Noninverting Input |
| — | — | — | — | 13 | 15 | 18 | IND- | Amplifier D Inverting Input |
| — | — | — | — | 14 | 16 | 19 | OUTD | Amplifier D Output |
| — | — | — | — | — | — | 20 | $\overline{\text{DISABLED}}$ | Shutdown Amplifier D. Connect to V _{CC} to Enable. |
| — | — | 8, 9 | — | — | 8, 9 | 10, 11 | N.C. | No Connection. Not internally connected. |

Detailed Description

The MAX4380–MAX4384 are single-supply, rail-to-rail, voltage-feedback amplifiers that employ current-feedback techniques to achieve 485V/μs slew rates and 210MHz bandwidths. Excellent harmonic distortion and differential gain/phase performance make these amplifiers an ideal choice for a wide variety of video and RF signal-processing applications.

Applications Information

The output voltage swings to within 50mV of each supply rail. Local feedback around the output stage ensures low open-loop output impedance to reduce gain sensitivity to load variations. The input stage permits common-mode voltages beyond the negative supply and to within 2.25V of the positive supply rail.

Choosing Resistor Values

Unity-Gain Configuration

The MAX4380–MAX4384 are internally compensated for unity gain. When configured for unity gain, a 24Ω resistor (R_F) in series with the feedback path optimizes AC performance. This resistor improves AC response by reducing the Q of the parallel LC circuit formed by the parasitic feedback capacitance and inductance.

Video Line Driver

The MAX4380–MAX4384 are low-power, voltage-feedback amplifiers featuring bandwidths up to 210MHz, 0.1dB gain flatness to 55MHz. They are designed to minimize differential-gain error and differential-phase error to 0.02% and 0.08 degrees respectively. They

Ultra-Small, Low-Cost, 210MHz, Single-Supply Op Amps with Rail-to-Rail Outputs and Disable

MAX4380-MAX4384

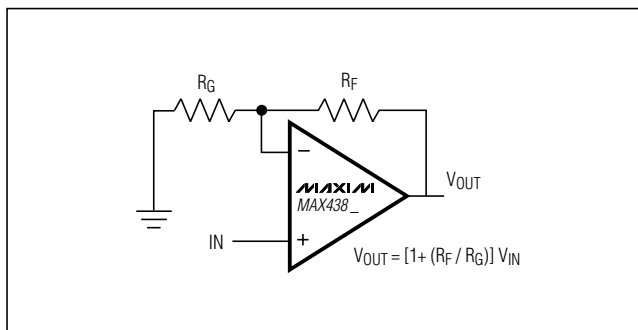

Figure 1a. Noninverting Gain Configuration

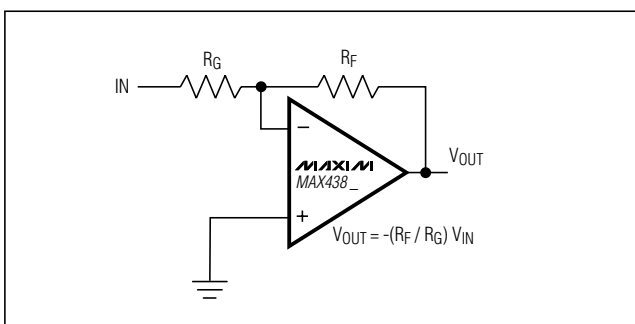

Figure 1b. Inverting Gain Configuration

have a 16ns settling time to 0.1%, 485V/ μ s slew rates, and output-current-drive capability of up to 75mA making them ideal for driving video loads.

Inverting and Noninverting Configurations

Select the gain-setting feedback (R_F) and input (R_G) resistor values to fit your application. Large resistor values increase voltage noise and interact with the amplifier's input and PC board capacitance. This can generate undesirable poles and zeros and decrease bandwidth or cause oscillations. For example, a noninverting gain-of-two configuration ($R_F = R_G$) using 1k Ω resistors, combined with 1pF of amplifier input capacitance and 1pF of PC board capacitance, causes a pole at 159MHz. Since this pole is within the amplifier bandwidth, it jeopardizes stability. Reducing the 1k Ω resistors to 100 Ω extends the pole frequency to 1.59GHz, but could limit output swing by adding 200 Ω in parallel with the amplifier's load resistor (Figures 1a and 1b).

Layout and Power-Supply Bypassing

These amplifiers operate from a single +4.5V to +11V power supply or from dual ± 2.25 V to ± 5.5 V supplies. For

single-supply operation, bypass V_{CC} to ground with a 0.1 μ F capacitor as close to the pin as possible. If operating with dual supplies, bypass each supply with a 0.1 μ F capacitor.

Maxim recommends using microstrip and stripline techniques to obtain full bandwidth. To ensure that the PC board does not degrade the amplifier's performance, design it for a frequency greater than 1GHz. Pay careful attention to inputs and outputs to avoid large parasitic capacitance. Whether or not you use a constant-impedance board, observe the following design guidelines:

- Don't use wire-wrap boards; they are too inductive.
- Don't use IC sockets; they increase parasitic capacitance and inductance.
- Use surface-mount instead of through-hole components for better high-frequency performance.
- Use a PC board with at least two layers; it should be as free from voids as possible.
- Keep signal lines as short and as straight as possible. Do not make 90° turns; round all corners.

Rail-to-Rail Outputs, Ground-Sensing Inputs

For +5V single-supply operation, the input common-mode range extends from ($V_{EE} - 200$ mV) to ($V_{CC} - 2.25$ V) with excellent common-mode rejection. Beyond this range, the amplifier output is a nonlinear function of the input, but does not undergo phase reversal or latchup.

For ± 5 V dual-supply operation, the common-mode range is from V_{EE} to ($V_{CC} - 2.25$ V)

For +5V single-supply operation the output swings to within 50mV of either power-supply rail with a 2k Ω load. The input ground sensing and the rail-to-rail output substantially increase the dynamic range. With a symmetric input in a single +5V application, the input can swing 2.95Vp-p and the output can swing 4.9Vp-p with minimal distortion.

Low-Power Disable Mode

The disable feature ($\overline{\text{DISABLE}}$) allows the amplifier to be placed in a low-power, high-output-impedance state. When the disable pin ($\overline{\text{DISABLE}}$) is active, the amplifier's output impedance is 35k Ω . This high resistance and the low 2pF output capacitance make the MAX4380-MAX4382 and the MAX4384 ideal in RF/video multiplexer or switch applications. For larger arrays, pay careful attention to capacitive loading. Refer to the *Output Capacitive Loading and Stability* section.

Ultra-Small, Low-Cost, 210MHz, Single-Supply Op Amps with Rail-to-Rail Outputs and Disable

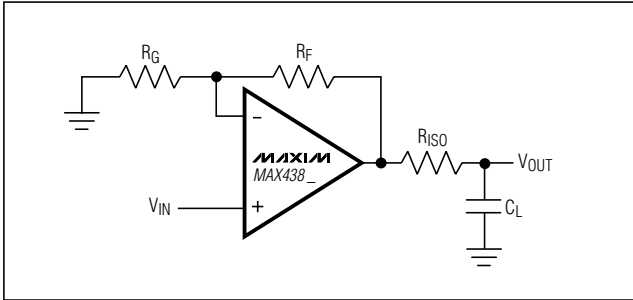

Figure 2. Driving a Capacitive Load Through an Isolation Resistor

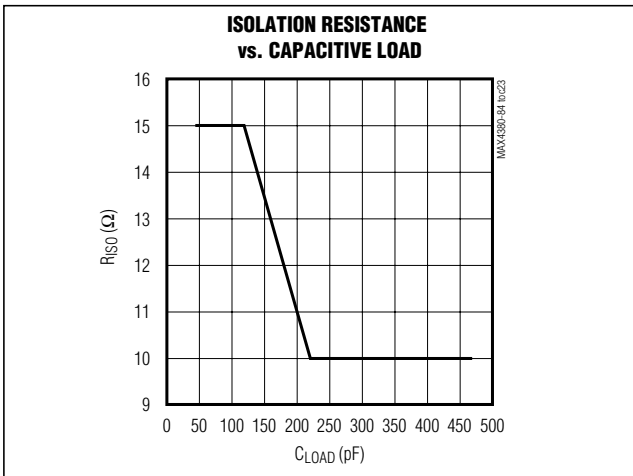

Figure 3. Isolation Resistance vs. Capacitive Load

Output Capacitive Loading and Stability

The MAX4380-MAX4384 are optimized for AC performance. They are not designed to drive highly reactive loads, which decrease phase margin and may produce excessive ringing and oscillation. Figure 2 shows a circuit that eliminates this problem. Figure 3 is a graph of the Optimal Isolation Resistor (R_S) vs. Capacitive Load. Figure 4 shows how a capacitive load causes excessive peaking of the amplifier's frequency response if the capacitor is not isolated from the amplifier by a resistor. A small isolation resistor (usually 10Ω to 15Ω) placed before the reactive load prevents ringing and oscillation. At higher capacitive loads, AC performance is controlled by the interaction of the load capacitance and the isolation resistor. Figure 5 shows the effect of a 15Ω isolation resistor on closed-loop response.

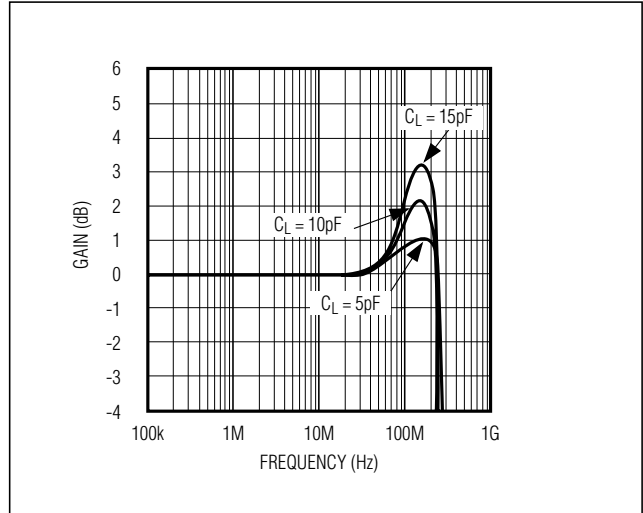

Figure 4. Small-Signal Gain vs. Frequency with Load Capacitance and No Isolation Resistor

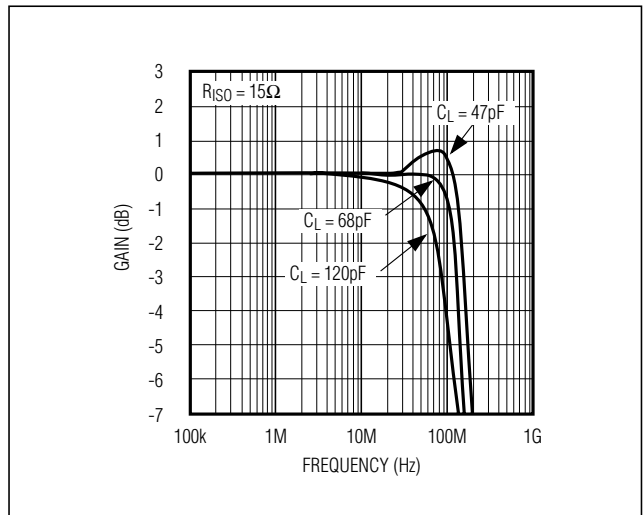

Figure 5. Small-Signal Gain vs. Frequency with Load Capacitance and 27Ω Isolation Resistor

Chip Information

- MAX4380 TRANSISTOR COUNT: 66
- MAX4381 TRANSISTOR COUNT: 132
- MAX4382 TRANSISTOR COUNT: 196
- MAX4383 TRANSISTOR COUNT: 264
- MAX4384 TRANSISTOR COUNT: 264

Ultra-Small, Low-Cost, 210MHz, Single-Supply Op Amps with Rail-to-Rail Outputs and Disable

Pin Configurations (continued)

MAX4380-MAX4384

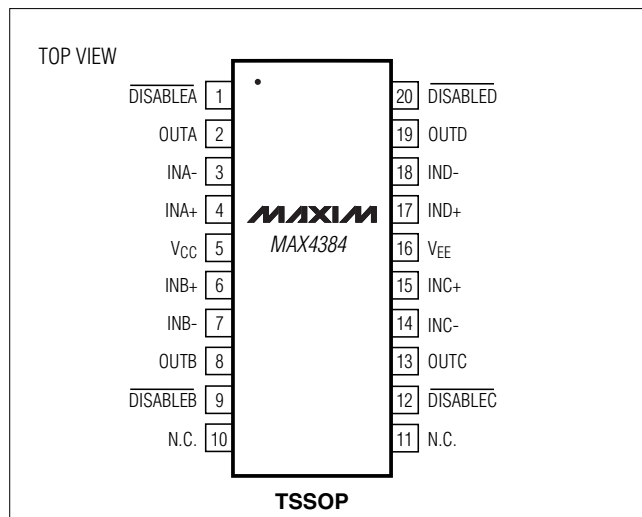
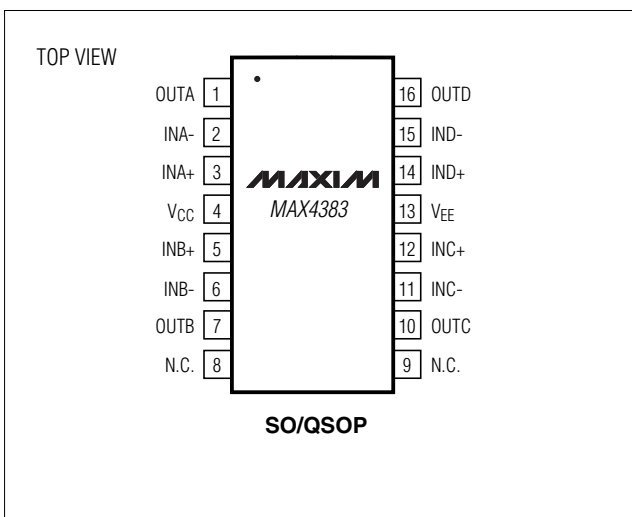
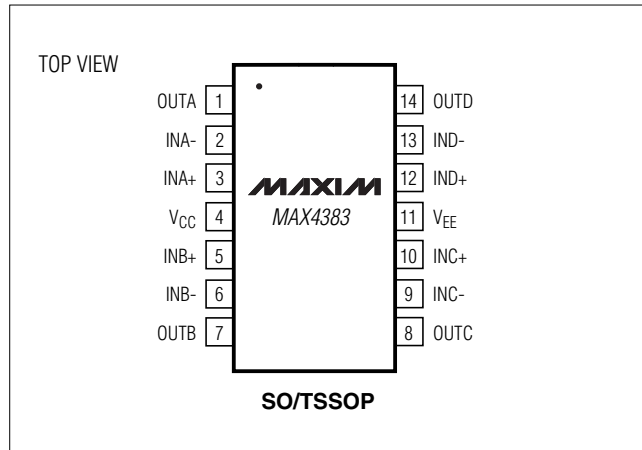
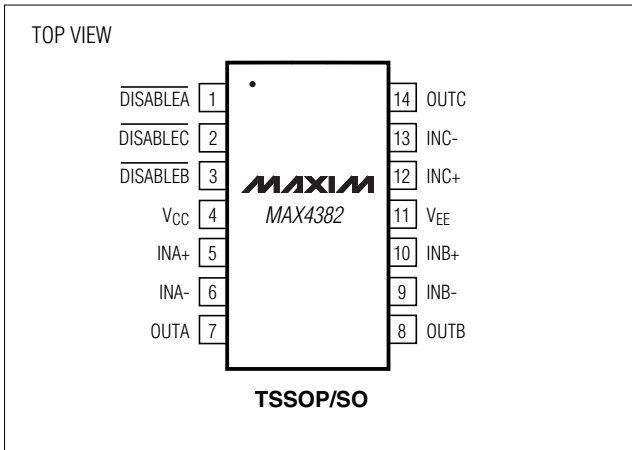
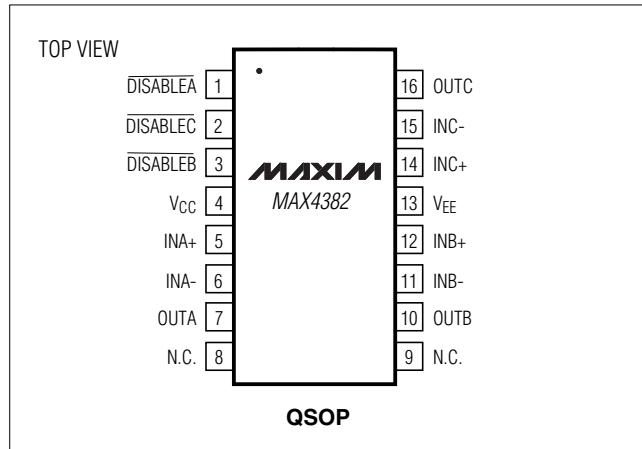
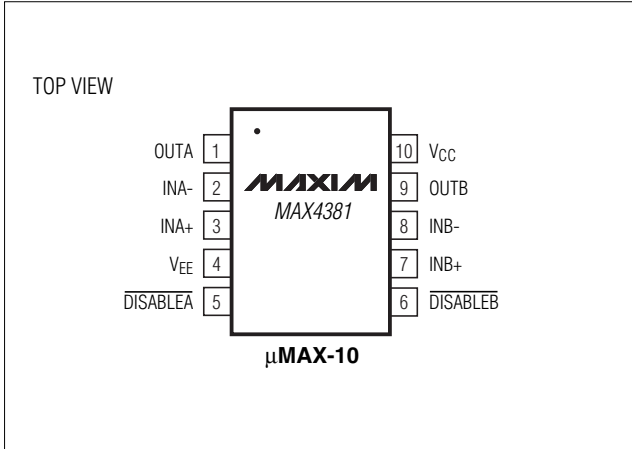

Ultra-Small, Low-Cost, 210MHz, Single-Supply Op Amps with Rail-to-Rail Outputs and Disable

Package Information

(The package drawing(s) in this data sheet may not reflect the most current specifications. For the latest package outline information go to www.maxim-ic.com/packages.)

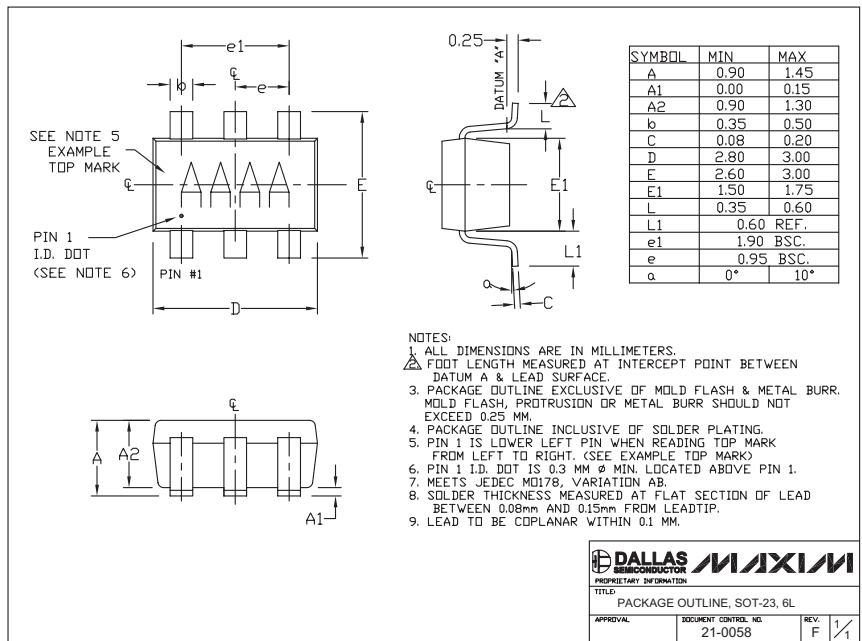
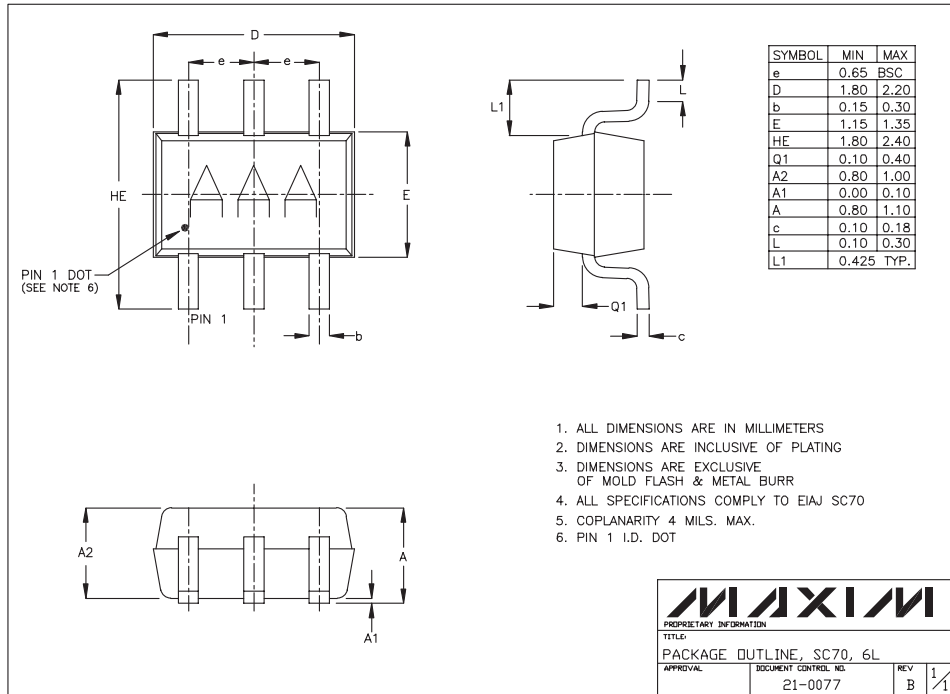

Ultra-Small, Low-Cost, 210MHz, Single-Supply Op Amps with Rail-to-Rail Outputs and Disable

Package Information (continued)

(The package drawing(s) in this data sheet may not reflect the most current specifications. For the latest package outline information go to www.maxim-ic.com/packages.)

MAX4380-MAX4384

