

# MAXIM

## 2.5Ω, Quad, SPST, CMOS Analog Switches

MAX4601/MAX4602/MAX4603

### General Description

The MAX4601/MAX4602/MAX4603 quad analog switches feature low on-resistance of 2.5Ω max. On-resistance is matched between switches to 0.5Ω max and is flat (0.5Ω max) over the specified signal range. Each switch can handle Rail-to-Rail® analog signals. The off-leakage current is only 2.5nA maximum at T<sub>A</sub> = +85°C. These analog switches are ideal in low-distortion applications and are the preferred solution over mechanical relays in automatic test equipment or applications where current switching is required. They have low power requirements, require less board space, and are more reliable than mechanical relays.

The MAX4601 has four normally closed (NC) switches, the MAX4602 has four normally open (NO) switches, and the MAX4603 has two NC and two NO switches.

These switches operate from a single supply of +4.5V to +36V or from dual supplies of ±4.5V to ±20V. All digital inputs have +0.8V and +2.4V logic thresholds, ensuring TTL/CMOS-logic compatibility when using ±15V or a single +12V supply.

### Applications

- Reed Relay Replacement
- Test Equipment
- Communication Systems
- PBX, PABX Systems
- Audio-Signal Routing
- Avionics

### Features

- ♦ **Low On-Resistance (2.5Ω max)**
- ♦ **Guaranteed R<sub>ON</sub> Match Between Channels (0.5Ω max)**
- ♦ **Guaranteed R<sub>ON</sub> Flatness over Specified Signal Range (0.5Ω max)**
- ♦ **Rail-to-Rail Signal Handling**
- ♦ **Guaranteed ESD Protection > 2000V per Method 3015.7**
- ♦ **Single-Supply Operation: +4.5V to +36V**  
**Dual-Supply Operation: ±4.5V to ±20V**
- ♦ **TTL/CMOS-Compatible Control Inputs**

### Ordering Information

PART	TEMP. RANGE	PIN-PACKAGE
MAX4601CAE	0°C to +70°C	16 SSOP
MAX4601CWE	0°C to +70°C	16 Wide SO
MAX4601CPE	0°C to +70°C	16 Plastic DIP
MAX4601EAE	-40°C to +85°C	16 SSOP
MAX4601EWE	-40°C to +85°C	16 Wide SO
MAX4601EPE	-40°C to +85°C	16 Plastic DIP

Ordering Information continued at end of data sheet.

### Pin Configurations/Functional Diagrams/Truth Tables

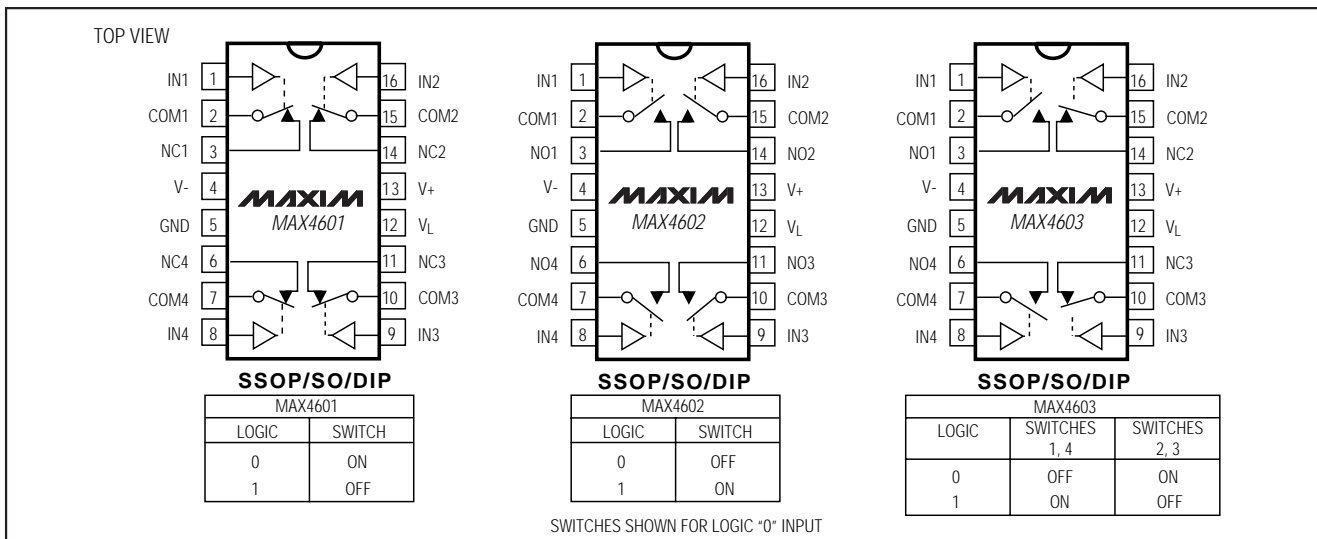

Rail-to-Rail is a registered trademark of Nippon Motorola, Ltd.



For free samples & the latest literature: <http://www.maxim-ic.com>, or phone 1-800-998-8800.  
For small orders, phone 1-800-835-8769.

# 2.5Ω, Quad, SPST, CMOS Analog Switches

## ABSOLUTE MAXIMUM RATINGS

V+ to GND .....	-0.3V to +44V	Continuous Power Dissipation (TA = +70°C)
V- to GND .....	+0.3V to -44V	16 SSOP (derate 7.1mW/°C above +70°C) .....
V+ to V- .....	-0.3V to +44V	16 Wide SO (derate 9.52mW/°C above +70°C) .....
VL to GND .....	(GND - 0.3V) to (V+ + 0.3V)	16 Plastic DIP (derate 10.53mW/°C above +70°C) .....
All Other Pins to DGND (Note 1) .....	(V- - 0.3V) to (V+ + 0.3V)	Operating Temperature Ranges
Continuous Current (COM_, NO_, NC_) .....	±200mA	MAX460_C_E .....
Peak Current (COM_, NO_, NC_) .....	±300mA	MAX460_E_E .....
(pulsed at 1ms, 10% duty cycle) .....	±300mA	Storage Temperature Range .....
		Lead Temperature (soldering, 10sec) .....

**Note 1:** Signals on NC\_, NO\_, COM\_, or IN\_ exceeding V+ or V- will be clamped by internal diodes. Limit forward diode current to maximum current rating.

Stresses beyond those listed under "Absolute Maximum Ratings" may cause permanent damage to the device. These are stress ratings only, and functional operation of the device at these or any other conditions beyond those indicated in the operational sections of the specifications is not implied. Exposure to absolute maximum rating conditions for extended periods may affect device reliability.

## ELECTRICAL CHARACTERISTICS—Dual Supplies

(V+ = +15V, V- = -15V, VL = 5V, VIN\_H = 2.4V, VIN\_L = 0.8V, TA = TMIN to TMAX, unless otherwise noted. Typical values are at TA = +25°C.)

PARAMETER	SYMBOL	CONDITIONS	MIN	TYP (Note 2)	MAX	UNITS
<b>ANALOG SWITCH</b>						
Input Voltage Range	VCOM_, VNO_, VNC_	(Note 3)	V-		V+	V
COM_ to NO or NC_ On-Resistance	RON	ICOM_ = 10mA, VNO_ or VNC_ = ±10V		1.7	2.5	Ω
			TA = TMIN to TMAX		2.7	
COM_ to NO_ or NC_ On-Resistance Match Between Channels (Note 4)	ΔRON	ICOM_ = 10mA, VNO_ or VNC_ = ±10V		0.1		Ω
			TA = TMIN to TMAX		0.5	
COM_ to NO_ or NC_ On-Resistance Flatness (Note 5)	RFLAT(ON)	ICOM_ = 10mA; VNO_ or VNC_ = -5V, 0, 5V		0.1	0.4	Ω
			TA = TMIN to TMAX		0.5	
Off-Leakage Current (NO_ or NC_) (Note 6)	INO_, INC_	VCOM_ = ±10V, VNO_ or VNC_ = ±10V		-0.5	0.01	nA
			TA = TMIN to TMAX	-2.5	2.5	
COM Off-Leakage Current (Note 6)	ICOM(OFF)	VCOM_ = ±10V, VNO_ or VNC_ = ±10V		-0.5	0.01	nA
			TA = TMIN to TMAX	-2.5	2.5	
COM On-Leakage Current (Note 6)	ICOM(ON)	VCOM_ = ±10V, VNO_ or VNC_ = ±10V or floating		-1	0.2	nA
			TA = TMIN to TMAX	-10	10	
<b>LOGIC INPUT</b>						
Input Current with Input Voltage High	IIN_H	IN_ = 2.4V, all others = 0.8V	-0.500	0.001	0.500	μA
Input Current with Input Voltage Low	IIN_L	IN_ = 0.8V, all others = 2.4V	-0.500	0.001	0.500	μA
Logic Input High Voltage	VIN_H		2.4	1.7		V
Logic Input Low Voltage	VIN_L			1.7	0.8	V

# 2.5Ω, Quad, SPST, CMOS Analog Switches

MAX4601/MAX4602/MAX4603

## ELECTRICAL CHARACTERISTICS—Dual Supplies (continued)

(V+ = +15V, V- = -15V, VL = 5V, VIN\_H = 2.4V, VIN\_L = 0.8V, TA = TMIN to TMAX, unless otherwise noted. Typical values are at TA = +25°C.)

PARAMETER	SYMBOL	CONDITIONS	MIN	TYP	MAX	UNITS	
<b>POWER SUPPLY</b>							
Power-Supply Range			±4.5		±20.0	V	
Positive Supply Current	I+	All channels on or off, VIN = 0 or 5V	TA = +25°C	-0.5	0.001	0.5	μA
			TA = TMIN to TMAX	-5		5	
Negative Supply Current	I-	All channels on or off, VIN = 0 or 5V	TA = +25°C	-0.5	0.001	0.5	μA
			TA = TMIN to TMAX	-5		5	
Logic Supply Current	IL	All channels on or off, VIN = 0 or 5V	TA = +25°C	-0.5	0.001	0.5	μA
			TA = TMIN to TMAX	-5		5	
Ground Current	IGND	All channels on or off, VIN = 0 or 5V	TA = +25°C	-0.5	0.001	0.5	μA
			TA = TMIN to TMAX	-5		5	
<b>SWITCH DYNAMIC CHARACTERISTICS</b>							
Turn-On Time	tON	Figure 2, VCOM_ = ±10V, TA = +25°C		160	250	ns	
Turn-Off Time	tOFF	Figure 2, VCOM_ = ±10V, TA = +25°C		190	350	ns	
Charge Injection	Q	CL = 1.0nF, VGEN = 0, RGEN = 0, Figure 3, TA = +25°C		120		pC	
Off-Isolation (Note 7)	VISO	RL = 50Ω, CL = 5pF, f = 1MHz, Figure 4, TA = +25°C		-56		dB	
Crosstalk (Note 8)	VCT	RL = 50Ω, CL = 5pF, f = 1MHz, Figure 5, TA = +25°C		-59		dB	
NC_ or NO_ Capacitance	C(OFF)	f = 1MHz, Figure 6, TA = +25°C		55		pF	
COM Off-Capacitance	C(COM)	f = 1MHz, Figure 6, TA = +25°C		55		pF	
On-Capacitance	C(COM)	f = 1MHz, Figure 7, TA = +25°C		250		pF	

# 2.5Ω, Quad, SPST, CMOS Analog Switches

MAX4601/MAX4602/MAX4603

## ELECTRICAL CHARACTERISTICS—Single +12V Supply

(V+ = 12V, V- = 0, VL = 5V, VIN\_H = 2.4V, VIN\_L = 0.8V, TA = TMIN to TMAX, unless otherwise noted. Typical values are at TA = +25°C.)

PARAMETER	SYMBOL	CONDITIONS	MIN	TYP (Note 2)	MAX	UNITS	
<b>ANALOG SWITCH</b>							
Input Voltage Range	VCOM_, VNO_, VNC_	(Note 3)	GND		V+	V	
COM_ to NO_ or NC_ On-Resistance	RON	ICOM_ = 10mA, VNO_ or VNC_ = 10V	TA = +25°C	3	4	Ω	
			TA = TMIN to TMAX		5		
COM_ to NO_ or NC_ On-Resistance Match Between Channels (Note 4)	ΔRON	ICOM_ = 10mA, VNO_ or VNC_ = 10V	TA = +25°C	0.03	0.4	Ω	
			TA = TMIN to TMAX		0.5		
COM_ to NO_ or NC_ On-Resistance Flatness (Note 5)	RFLAT(ON)	ICOM_ = 10mA; VNO_ or VNC_ = 3V, 6V, 9V	TA = +25°C	0.1	0.4	Ω	
			TA = TMIN to TMAX		0.5		
Off-Leakage Current (NO_ or NC_) (Notes 6, 9)	I <sub>NO_</sub> I <sub>NC_</sub>	VCOM_ = 1V, 10V; VNO_ or VNC_ = 10V, 1V	TA = +25°C	-0.5	0.01	0.5	nA
			TA = TMIN to TMAX	-2.5		2.5	
COM Off-Leakage Current (Notes 6, 9)	ICOM(OFF)	VNO_ or VNC_ = 10V, 1V; VCOM_ = 1V, 10V	TA = +25°C	-0.5	0.01	0.5	nA
			TA = TMIN to TMAX	-2.5		2.5	
COM On-Leakage Current (Notes 6, 9)	ICOM(ON)	VCOM_ = 1V, 10V; VNO_ or VNC_ = 1V, 10V, or floating	TA = +25°C	-1	0.01	1	nA
			TA = TMIN to TMAX	-10		10	
<b>LOGIC INPUT</b>							
Input Current with Input Voltage High	IIN_H	IN_ = 2.4V, all others = 0.8V		-0.500	0.001	0.500	μA
Input Current with Input Voltage Low	IIN_L	IN_ = 0.8V, all others = 2.4V		-0.500	0.001	0.500	μA
Logic Input High Voltage	VIN_H			2.4			V
Logic Input Low Voltage	VIN_L					0.8	V
<b>POWER SUPPLY</b>							
Power-Supply Range				4.5		36.0	V
Positive Supply Current	I+	All channels on or off, VIN = 0 or 5V	TA = +25°C	-0.5	0.001	0.5	μA
			TA = TMIN to TMAX	-5		5	
Logic Supply Current	IL	All channels on or off, VIN = 0 or 5V	TA = +25°C	-0.5	0.001	0.5	μA
			TA = TMIN to TMAX	-5		5	
Ground Current	IGND	VIN = 0 or 5V	TA = +25°C	-0.5	0.001	0.5	μA
			TA = TMIN to TMAX	-5		5	

# 2.5Ω, Quad, SPST, CMOS Analog Switches

MAX4601/MAX4602/MAX4603

## ELECTRICAL CHARACTERISTICS—Single +12V Supply (continued)

(V<sub>+</sub> = 12V, V<sub>-</sub> = 0, V<sub>L</sub> = 5V, V<sub>IN\_H</sub> = 2.4V, V<sub>IN\_L</sub> = 0.8V, T<sub>A</sub> = T<sub>MIN</sub> to T<sub>MAX</sub>, unless otherwise noted. Typical values are at T<sub>A</sub> = +25°C.)

PARAMETER	SYMBOL	CONDITIONS	MIN	TYP (Note 2)	MAX	UNITS
<b>SWITCH DYNAMIC CHARACTERISTICS</b>						
Turn-On Time	t <sub>ON</sub>	Figure 2, V <sub>COM_</sub> = 10V, T <sub>A</sub> = +25°C		160		ns
Turn-Off Time	t <sub>OFF</sub>	Figure 2, V <sub>COM_</sub> = 10V, T <sub>A</sub> = +25°C		170		ns
Charge Injection	Q	C <sub>L</sub> = 1.0nF, V <sub>GEN</sub> = 0, R <sub>GEN</sub> = 0, Figure 3, T <sub>A</sub> = +25°C		20		pC
Crosstalk (Note 8)	V <sub>CT</sub>	R <sub>L</sub> = 50Ω, C <sub>L</sub> = 5pF, f = 1MHz, Figure 5, T <sub>A</sub> = +25°C		-60		dB
NC_ or NO_ Capacitance	C <sub>(OFF)</sub>	f = 1MHz, Figure 6, T <sub>A</sub> = +25°C		85		pF
COM Off-Capacitance	C <sub>(COM)</sub>	f = 1MHz, Figure 6, T <sub>A</sub> = +25°C		85		pF
On-Capacitance	C <sub>(COM)</sub>	f = 1MHz, Figure 7, T <sub>A</sub> = +25°C		140		pF

**Note 2:** The algebraic convention, where the most negative value is a minimum and the most positive value a maximum, is used in this data sheet.

**Note 3:** Guaranteed by design.

**Note 4:**  $\Delta R_{ON} = R_{ON(MAX)} - R_{ON(MIN)}$ .

**Note 5:** Flatness is defined as the difference between the maximum and minimum value of on-resistance as measured over the specified analog signal range.

**Note 6:** Leakage parameters are 100% tested at maximum-rated hot temperature and guaranteed by correlation at +25°C.

**Note 7:** Off-isolation =  $20 \log_{10} [V_{COM} / (V_{NC} \text{ or } V_{NO})]$ , V<sub>COM</sub> = output, V<sub>NC</sub> or V<sub>NO</sub> = input to off switch.

**Note 8:** Between any two switches.

**Note 9:** Leakage testing at single supply is guaranteed by testing with dual supplies.

# 2.5Ω, Quad, SPST, CMOS Analog Switches

## Typical Operating Characteristics

( $T_A = +25^\circ\text{C}$ , unless otherwise noted.)

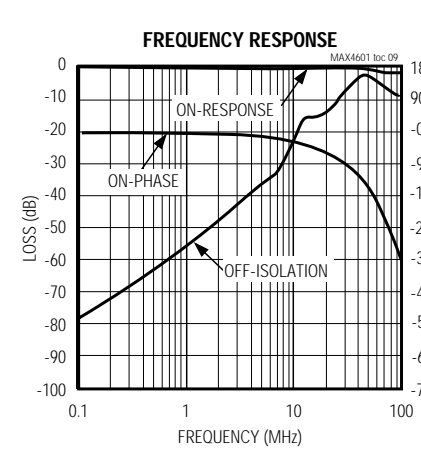
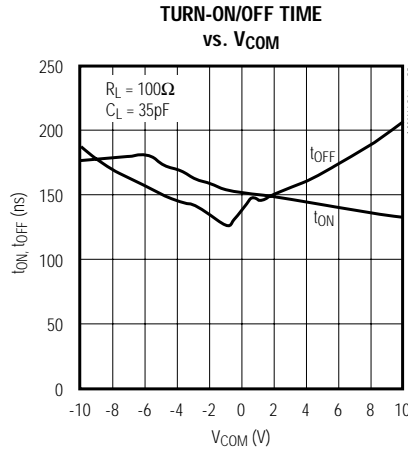
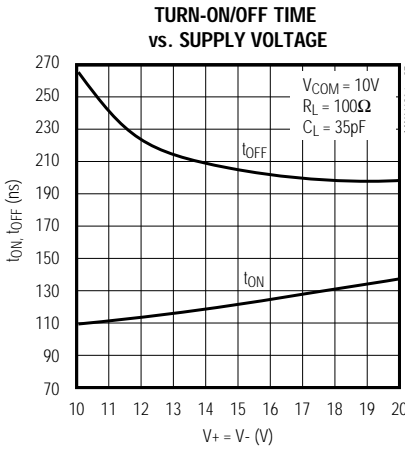
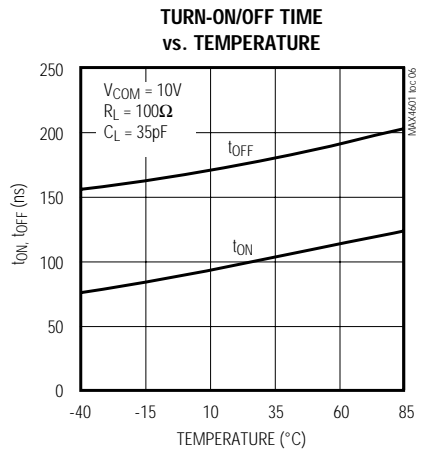
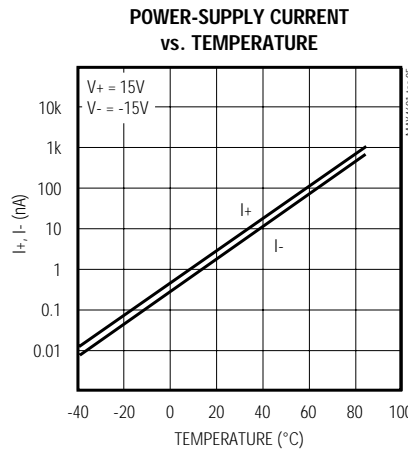
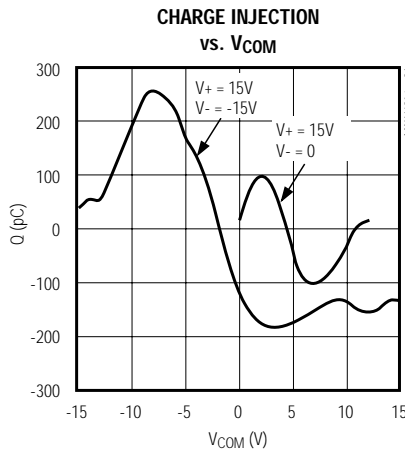
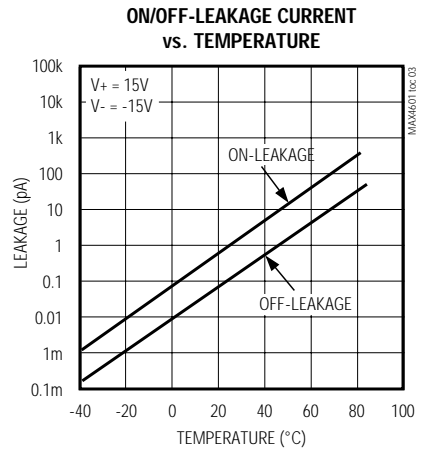
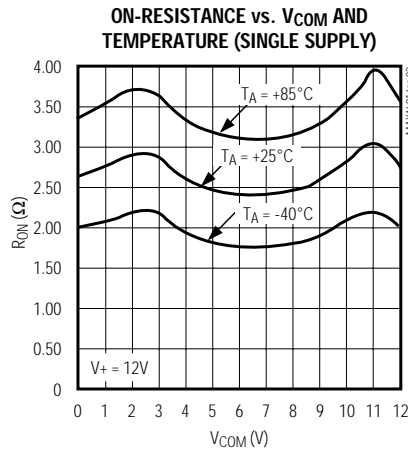
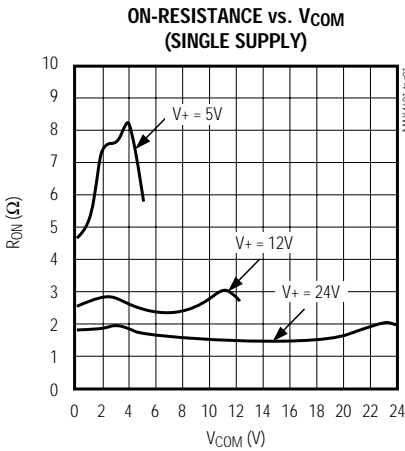

# 2.5Ω, Quad, SPST, CMOS Analog Switches

## Typical Operating Characteristics (continued)

( $T_A = +25^\circ\text{C}$ , unless otherwise noted.)

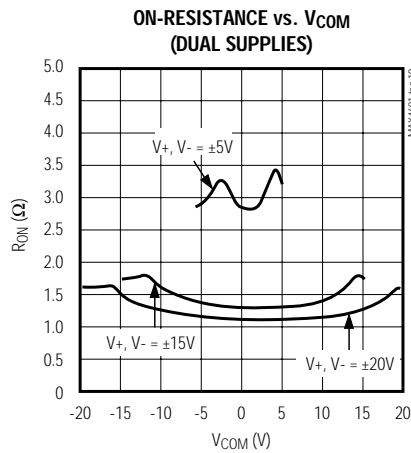

## Pin Description

PIN			NAME	FUNCTION
MAX4601	MAX4602	MAX4603		
1, 16, 9, 8	1, 16, 9, 8	1, 16, 9, 8	IN1, IN2, IN3, IN4	Logic-Control Digital Inputs
2, 15, 10, 7	2, 15, 10, 7	2, 15, 10, 7	COM1, COM2, COM3, COM4	Analog Switch Common Terminals
3, 14, 11, 6	—	—	NC1, NC2, NC3, NC4	Analog Switch Normally Closed Terminals
—	3, 14, 11, 6	—	NO1, NO2, NO3, NO4	Analog Switch Normally Open Terminals
—	—	3, 6	NO1, NO4	Analog Switch Normally Open Terminals
—	—	14, 11	NC2, NC3	Analog Switch Normally Closed Terminals
4	4	4	V-	Negative Analog Supply-Voltage Input. Connect to GND for single-supply operation.
5	5	5	GND	Ground
12	12	12	V <sub>L</sub>	Logic-Supply Input
13	13	13	V+	Positive Analog Supply Input

MAX4601/MAX4602/MAX4603

# 2.5Ω, Quad, SPST, CMOS Analog Switches

## Applications Information

### Overvoltage Protection

Proper power-supply sequencing is recommended for all CMOS devices. Do not exceed the absolute maximum ratings, because stresses beyond the listed ratings can cause permanent damage to the devices. Always sequence V+ on first, then V-, followed by the logic inputs, NO, or COM. If power-supply sequencing is not possible, add two small signal diodes (D1, D2) in series with the supply pins for overvoltage protection (Figure 1). Adding diodes reduces the analog signal range to one diode drop below V+ and one diode drop above V-, but does not affect the devices' low switch resistance and low leakage characteristics. Device operation is unchanged, and the difference between V+ and V- should not exceed 44V. These protection diodes are not recommended when using a single supply.

### Off-Isolation at High Frequencies

In 50Ω systems, the high-frequency on-response of these parts extends from DC to above 100MHz with a typical loss of -2dB. When the switch is turned off, however, it behaves like a capacitor, and off-isolation decreases with increasing frequency. (Above 300MHz, the switch actually passes more signal turned off than turned on.) This effect is more pronounced with higher source and load impedances.

Above 5MHz, circuit board layout becomes critical, and it becomes difficult to characterize the response of the

switch independent of the circuit. The graphs shown in the *Typical Operating Characteristics* were taken using a 50Ω source and load connected with BNC connectors to a circuit board deemed "average;" that is, designed with isolation in mind, but not using strip-line or other special RF circuit techniques. For critical applications above 5MHz, use the MAX440, MAX441, and MAX442, which are fully characterized up to 160MHz.



Figure 1. Overvoltage Protection Using External Blocking Diodes

## Timing Diagrams/Test Circuits



Figure 2. Switching-Time Test Circuit



# 2.5Ω, Quad, SPST, CMOS Analog Switches

Timing Diagrams/Test Circuits (continued)



Figure 3. Charge-Injection Test Circuit

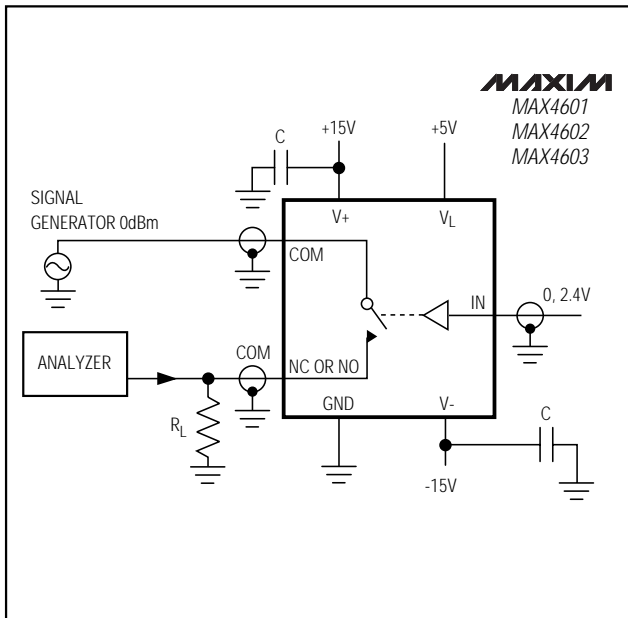

Figure 4. Off-Isolation Test Circuit

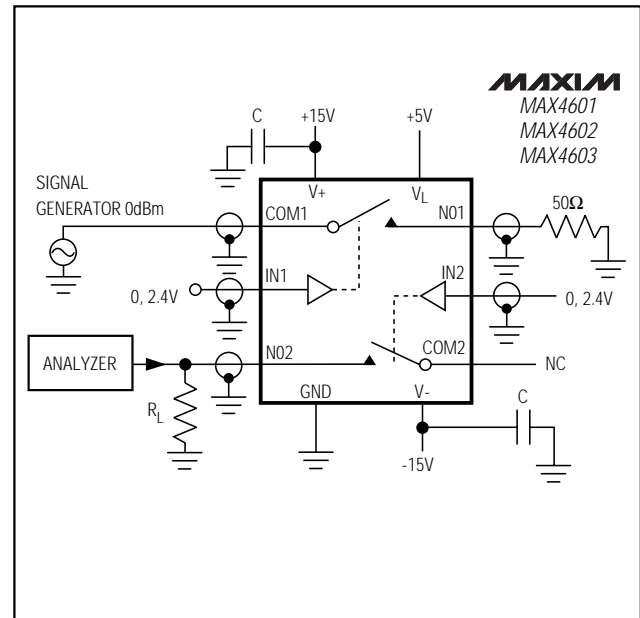

Figure 5. Crosstalk Test Circuit

MAX4601/MAX4602/MAX4603

# 2.5Ω, Quad, SPST, CMOS Analog Switches

## Timing Diagrams/Test Circuits (continued)



Figure 6. Switch Off-Capacitance Test Circuit

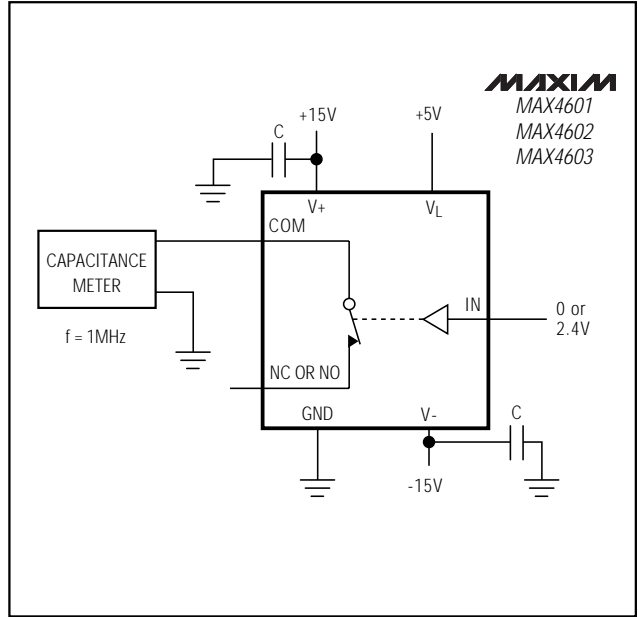

Figure 7. Switch On-Capacitance Test Circuit

## Ordering Information (continued)

PART	TEMP. RANGE	PIN-PACKAGE
<b>MAX4602</b> CAE	0°C to +70°C	16 SSOP
MAX4602CWE	0°C to +70°C	16 Wide SO
MAX4602CPE	0°C to +70°C	16 Plastic DIP
MAX4602EAE	-40°C to +85°C	16 SSOP
MAX4602EWE	-40°C to +85°C	16 Wide SO
MAX4602EPE	-40°C to +85°C	16 Plastic DIP
<b>MAX4603</b> CAE	0°C to +70°C	16 SSOP
MAX4603CWE	0°C to +70°C	16 Wide SO
MAX4603CPE	0°C to +70°C	16 Plastic DIP
MAX4603EAE	-40°C to +85°C	16 SSOP
MAX4603EWE	-40°C to +85°C	16 Wide SO
MAX4603EPE	-40°C to +85°C	16 Plastic DIP

## Chip Information

TRANSISTOR COUNT: 100

# 2.5Ω, Quad, SPST, CMOS Analog Switches

## Package Information

MAX4601/MAX4602/MAX4603

DIM	INCHES		MILLIMETERS	
	MIN	MAX	MIN	MAX
A	0.068	0.078	1.73	1.99
A1	0.002	0.008	0.05	0.21
B	0.010	0.015	0.25	0.38
C	0.004	0.008	0.09	0.20
D	SEE VARIATIONS			
E	0.205	0.209	5.20	5.38
e	0.0256	BSC	0.65	BSC
H	0.301	0.311	7.65	7.90
L	0.025	0.037	0.63	0.95
α	0°	8°	0°	8°

D	INCHES		MILLIMETERS		
	MIN	MAX	MIN	MAX	
D	0.239	0.249	6.07	6.33	14L
D	0.239	0.249	6.07	6.33	16L
D	0.278	0.289	7.07	7.33	20L
D	0.317	0.328	8.07	8.33	24L
D	0.397	0.407	10.07	10.33	28L

NOTES:

- D&E DO NOT INCLUDE MOLD FLASH.
- MOLD FLASH OR PROTRUSIONS NOT TO EXCEED .15mm (.006")
- CONTROLLING DIMENSION: MILLIMETER

<b>MAXIM</b>			
<small>PROPRIETARY INFORMATION</small>			
<small>TITLE:</small>			
PACKAGE OUTLINE, SSOP, 5.3X.65mm			
<small>APPROVAL</small>	<small>DOCUMENT CONTROL NO.</small>	<small>REV</small>	<small>1/1</small>
	21-0056	A	

SSOP/EPS