

MAX49017

1.7V, Dual microPower Comparator with Built-In Reference

General Description

The MAX49017 is a space-saving, dual comparator with a built-in voltage reference and push-pull output. The device is AEC-Q100 qualified, which is ideal for automotive applications: car battery monitoring systems, infotainment head units, and ADAS modules. The MAX49017 is available in an 8-pin, 2mm x 2mm TDFN package with side-wettable flanks.

The device features a Beyond-the-Rails™ input, offers a supply voltage range from 1.7V to 5.5V, and consumes only 1.35µA of supply current. The device also features internal filtering to provide high RF immunity, which is important in automotive systems.

The device has a built-in 1.252V reference that is factory-trimmed to an initial accuracy of 1% and better than 2.5% over the entire temperature range. The reference output is stable for capacitive loads up to 100pF or above 0.1µF (with an unstable region from 100pF and 0.1µF).

The MAX49017 is fully specified over the -40°C to +125°C automotive temperature range.

Applications

- Automotive
 - Car Battery Monitoring Systems
 - ADAS

Benefits and Features

- Micropower Operating Current (Total 1.35µA (typ), 2.55µA (max)) Preserves Battery Power
- Internal Precision Reference Saves Space and Cost of an External Reference
 - < 1% at Room Temperature, < 2.5% over Temperature Reference
- ±200mV (typ) Beyond-the-Rails Input Voltage Range
- Supply Voltage Range (1.7V to 5.5V) Allows Operation from 1.8V, 2.5V, 3V, and 5V Supplies
- < 10µs Propagation Delay
- Push-Pull Output
- Tiny, 2mm x 2mm, 8-Pin Side-Wettable TDFN Package with Exposed Pad Saves Board Space
- Enable Automotive Safety Integrity Level (ASIL) Compliance
- AEC-Q100 Qualified, See Ordering Information for the List of /V Parts

[Ordering Information](#) appears at end of data sheet.

Simplified Block Diagram

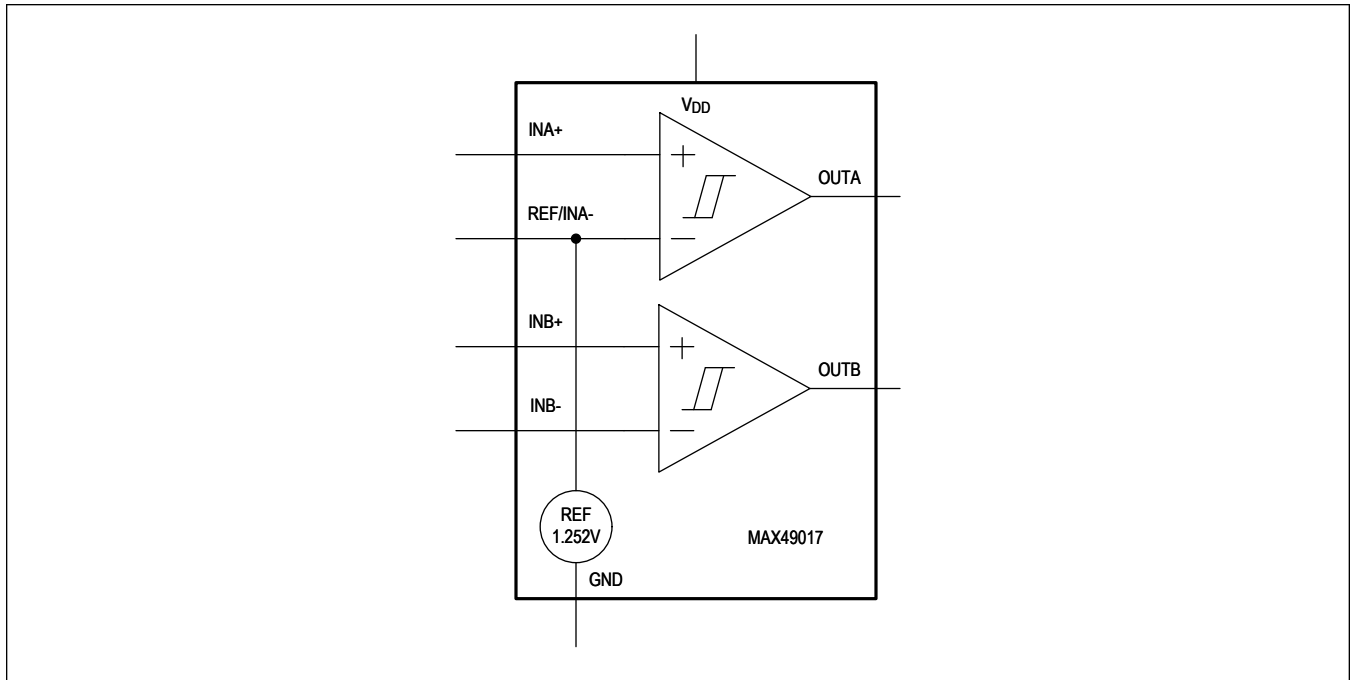

TABLE OF CONTENTS

General Description	1
Applications	1
Benefits and Features	1
Simplified Block Diagram	2
Absolute Maximum Ratings	5
Package Information	5
8 TDFN (SW EP)	5
Electrical Characteristics	5
Typical Operating Characteristics	8
Pin Configuration	11
8 TDFN	11
Pin Description	12
Detailed Description	13
Input Stage Circuitry	13
Output Stage Structure	13
Voltage Reference	13
Applications Information	14
Internal Hysteresis	14
Adding External Hysteresis	14
Component Selection	15
Board Layout and Bypassing	15
Window Detector	15
Design Procedure	15
Typical Application Circuit	16
Ordering Information	17
Revision History	18

LIST OF FIGURES

Figure 1. Hysteresis Band 14
Figure 2. External Hysteresis on MAX49017 15

Absolute Maximum Ratings

V _{DD} to GND.....	-0.3V to +6V	Continuous Power Dissipation (T _A = +70°C), Multilayer Board
INA+, REF/INA-, INB+, INB- to GND.....	-0.3V to V _{DD} + 0.3V	TDFN (derate 11.7mW/°C above 70°C).....
OUTA, OUTB to GND.....	-0.3V to V _{DD} + 0.3V	Operating Temperature Range
Comparator Output Short Circuit Current Duration	10s	Junction Temperature (T _{JMAX}).....
Reference Output Short-Circuit Current Duration	Indefinite	Storage Temperature Range
Continuous Current Into/Out of Any Input Pin	20mA	Lead Temperature (soldering, 10s).....
Continuous Current Into/Out of Any Output Pin	50mA	Soldering Temperature (reflow)

Stresses beyond those listed under "Absolute Maximum Ratings" may cause permanent damage to the device. These are stress ratings only, and functional operation of the device at these or any other conditions beyond those indicated in the operational sections of the specifications is not implied. Exposure to absolute maximum rating conditions for extended periods may affect device reliability.

Package Information

8 TDFN (SW EP)

Package Code	T822Y+3C
Outline Number	21-100185
Land Pattern Number	90-100070
Thermal Resistance, Multilayer Board:	
Junction-to-Ambient (θ _{JA})	85.3°C/W
Junction-to-Case Thermal Resistance (θ _{JC})	8.9°C/W

SW is side-wettable and EP is exposed pad.

For the latest package outline information and land patterns (footprints), go to www.maximintegrated.com/packages. Note that a "+", "#", or "-" in the package code indicates RoHS status only. Package drawings may show a different suffix character, but the drawing pertains to the package regardless of RoHS status.

Package thermal resistances were obtained using the method described in JEDEC specification JESD51-7, using a four-layer board. For detailed information on package thermal considerations, refer to www.maximintegrated.com/thermal-tutorial.

Electrical Characteristics

(V_{DD} = 3.3V, V_{CM} = 1.25V, T_A = -40°C to +125°C. Typical values are at T_A = +25°C, unless otherwise noted. (Note 1))

PARAMETER	SYMBOL	CONDITIONS	MIN	TYP	MAX	UNITS
POWER SUPPLY VOLTAGE						
V _{DD} Supply Voltage Range	V _{DD}	Guaranteed by PSRR specification	1.7		5.5	V
V _{DD} Supply Current	I _{DD}	No output or reference load current, T _A = -40°C to +125°C		1.35	2.55	µA
Power-Up Time				5		µs
COMPARATOR						
Input Common-Mode Voltage Range	V _{CM}	T _A = +25°C	-0.2		V _{DD} + 0.2	V
		T _A = -40°C to +125°C	0		V _{DD}	

Electrical Characteristics (continued)

(V_{DD} = 3.3V, V_{CM} = 1.25V, T_A = -40°C to +125°C. Typical values are at T_A = +25°C, unless otherwise noted. (Note 1))

PARAMETER	SYMBOL	CONDITIONS	MIN	TYP	MAX	UNITS
Input Offset Voltage	V _{OS}	V _{CM} = 0V to V _{DD} -1V (Note 2)			8	mV
		V _{CM} = V _{DD} -1V to V _{DD} , T _A = 0°C to +85°C (Note 2)			10	
		V _{CM} = V _{DD} -1V to V _{DD} , T _A = -40°C to +125°C (Note 2)			14	
Input Offset Drift				27		μV/°C
Input Hysteresis	V _{HYS}	(Note 3)		2.5		mV
Input Bias Current		V _{CM} = -0.2V to V _{DD} +0.2V, T _A = +25°C		2	5	nA
		V _{CM} = 0V to V _{DD} , T _A = -40°C to +85°C			5	
		V _{CM} = 0.2V to V _{DD} , T _A = -40°C to +125°C			5	
Input Offset Current					5	nA
Input Capacitance		Either input, over V _{CM} range		2		pF
Power-Supply Rejection Ratio	PSRR	DC, over the entire common-mode input voltage range	50			dB
Common-Mode Rejection Ratio	CMRR	DC, over the entire common-mode input voltage range	46			dB
Output Voltage Swing Low	V _{OL}	Sinking 2mA output current, V _{OUT} - V _{GND}			0.4	V
Output Voltage Swing High	V _{OH}	Sourcing 2mA output current, V _{DD} - V _{OUT}			0.4	V
Propagation Delay (Note 4)	t _{PD}	100mV overdrive, output low-to-high		9.6		μs
		100mV overdrive, output high-to-low		3.2		
		20mV overdrive, output low-to-high		9.9		
		20mV overdrive, output high-to-low		5.2		
Rise Time	t _R	25% to 75%, C _L = 15pF		300		ns
Fall Time	t _F	75% to 25%, C _L = 15pF		52		ns
INTERNAL REFERENCE VOLTAGE						
Reference Voltage	V _{REF}	T _A = -40°C to +125°C	1.21875	1.25	1.28125	V
		T _A = +25°C	1.2375	1.25	1.2625	
Reference Thermal Drift	V _{REF-TEMPCO}	Over extended temperature range, T _A = -40°C to +125°C		15		ppm/°C
Line Regulation					1200	ppm/V
Load Regulation		I _{VREFOUT} = ±100nA			0.01	mV/nA
Output Current (Note 5)			0.1			μA
Voltage Noise		0.1Hz to 10Hz		82		μV _{P-P}
		10Hz to 10kHz		100		μV _{RMS}

Note 1: All specifications are 100% production tested at T_A = +25°C. Specification limits over temperature (T_A = T_{MIN} to T_{MAX}) are guaranteed by design, not production tested.

Note 2: Input offset voltage; V_{OS} is defined as the center of the hysteresis band or average of the threshold trip points.

Note 3: The hysteresis-related trip points are defined as the edges of the hysteresis band, measured with respect to the center of the band (i.e., V_{OS}) ([Figure 1](#)).

Note 4: Specified with an input overdrive ($V_{OVERDRIVE}$) of 100mV and 20mV, and load capacitance of $C_L = 15\text{pF}$. $V_{OVERDRIVE}$ is defined above the offset voltage and hysteresis of the comparator input. The reference voltage error should also be added.

Note 5: Guaranteed by load regulation.

Typical Operating Characteristics

($V_{DD} = 3.3V$, $T_A = +25^\circ C$, unless otherwise noted.)

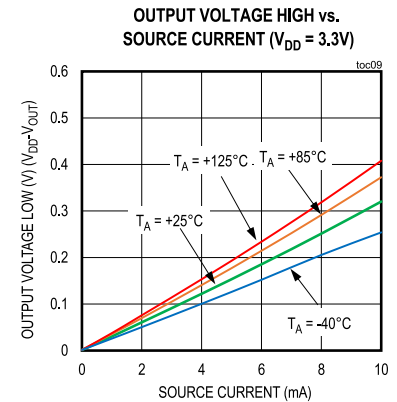
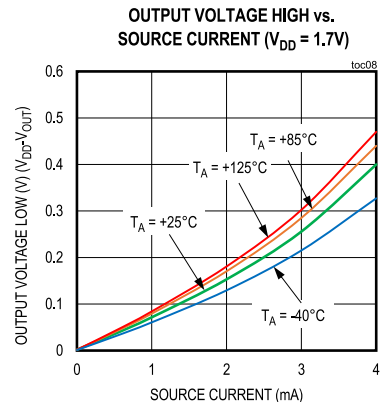
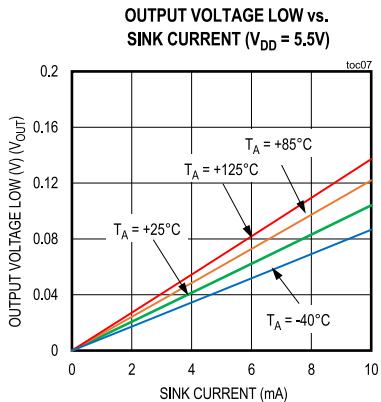
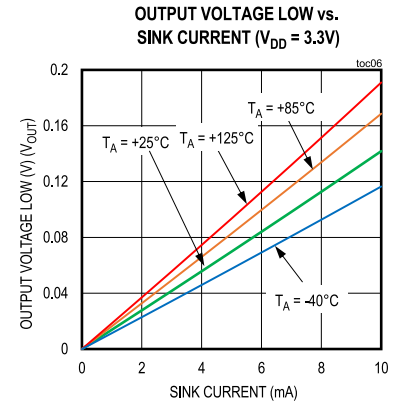
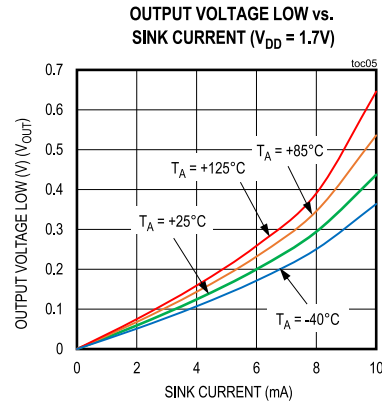
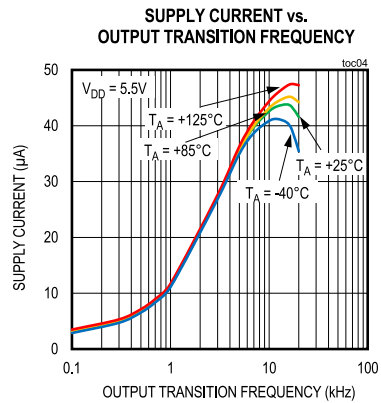
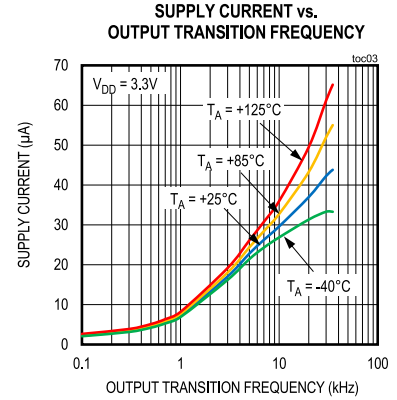
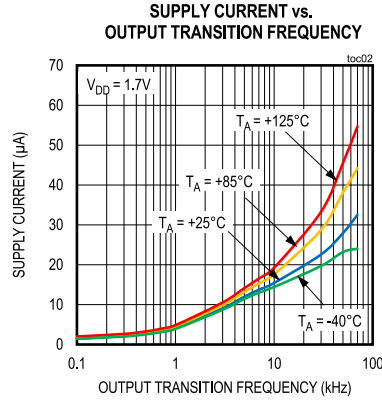
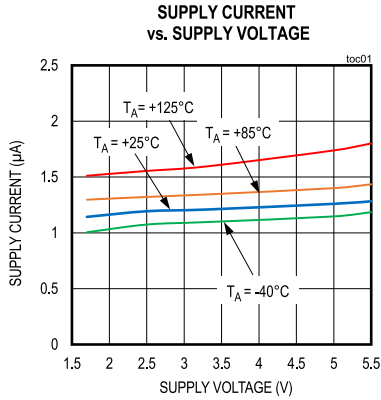

Typical Operating Characteristics (continued)

($V_{DD} = 3.3V$, $T_A = +25^\circ C$, unless otherwise noted.)

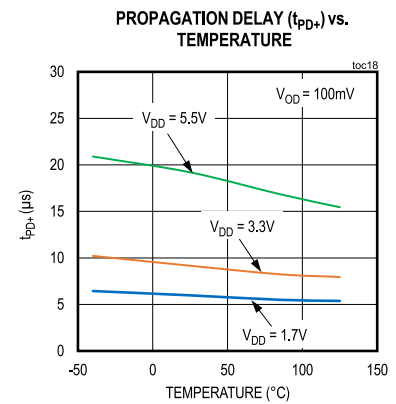
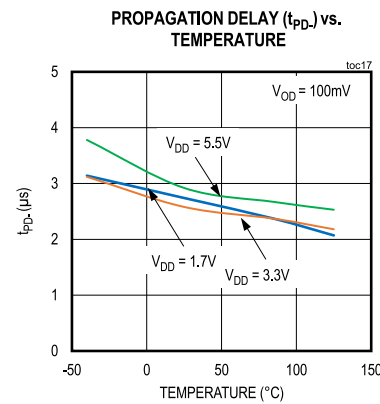
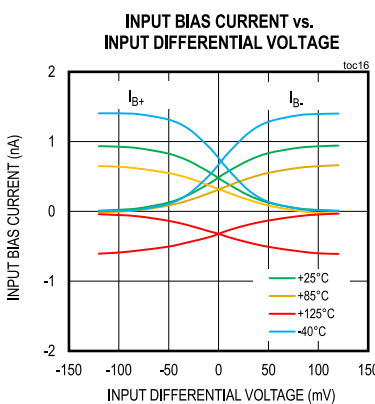
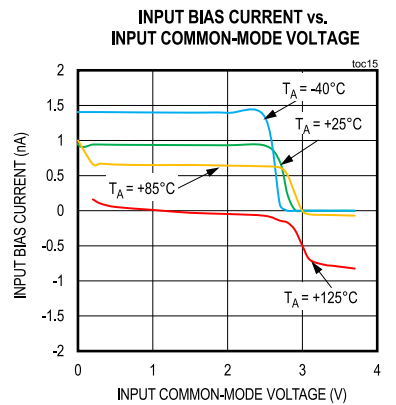
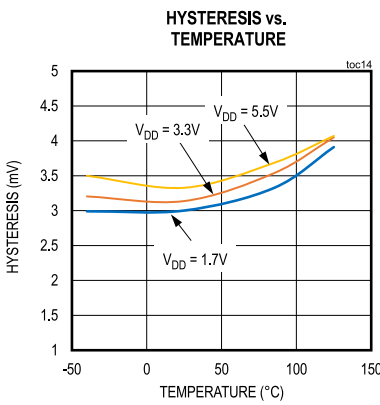
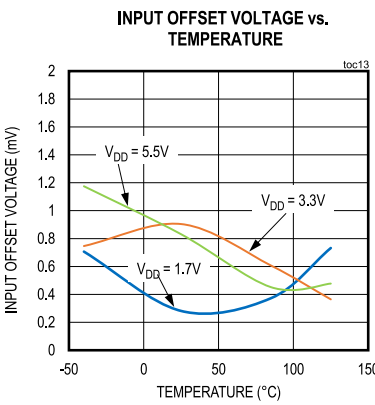
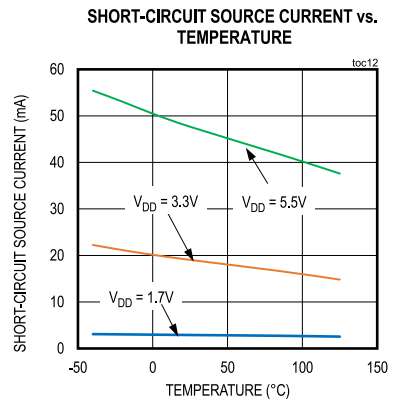
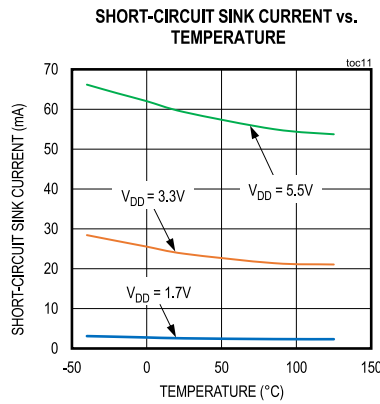
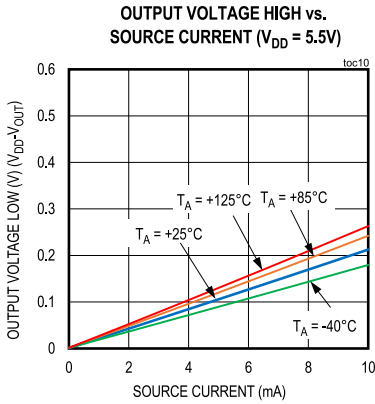

Typical Operating Characteristics (continued)

($V_{DD} = 3.3V$, $T_A = +25^\circ C$, unless otherwise noted.)

PROPAGATION DELAY (t_{PD}) vs. CAPACITIVE LOAD

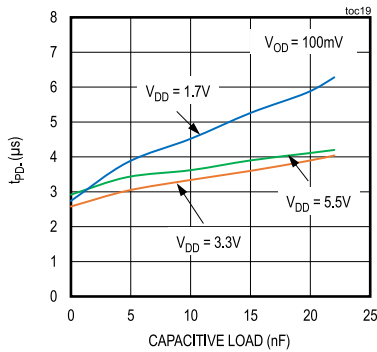

PROPAGATION DELAY (t_{PD+}) vs. CAPACITIVE LOAD

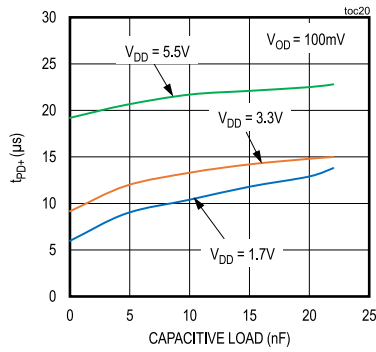

PROPAGATION DELAY (t_{PD}) vs. INPUT OVERDRIVE

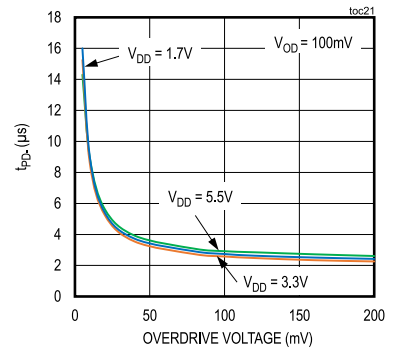

PROPAGATION DELAY (t_{PD}) vs. INPUT OVERDRIVE

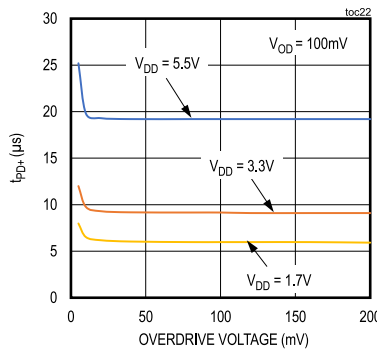

PROPAGATION DELAY t_{PD+} ($V_{DD} = 3.3V$)

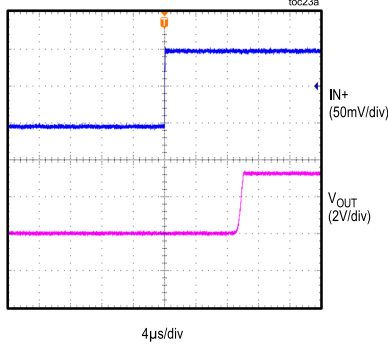

PROPAGATION DELAY t_{PD} ($V_{DD} = 3.3V$)

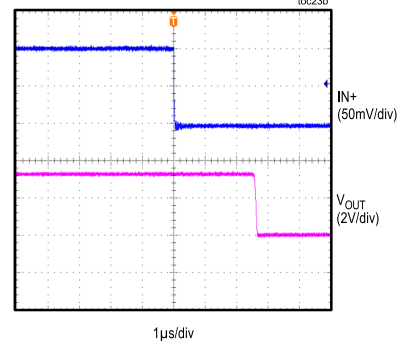

1kHz FREQUENCY RESPONSE ($V_{DD} = 3.3V$)

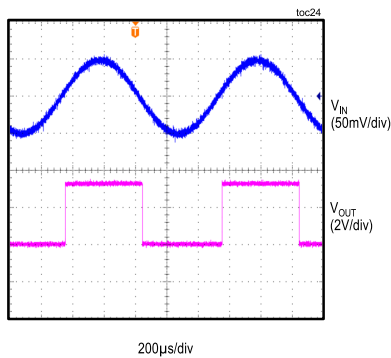

10kHz FREQUENCY RESPONSE ($V_{DD} = 3.3V$)

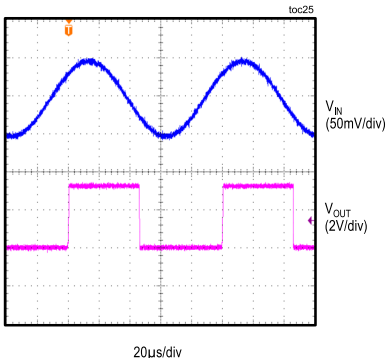

REFERENCE VOLTAGE vs. TEMPERATURE

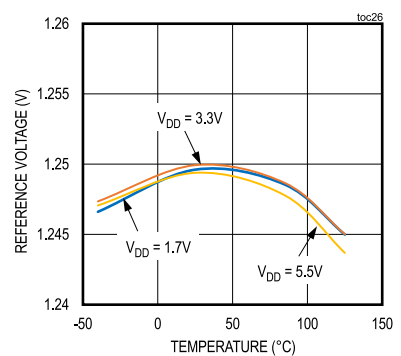

Typical Operating Characteristics (continued)

($V_{DD} = 3.3V$, $T_A = +25^\circ C$, unless otherwise noted.)

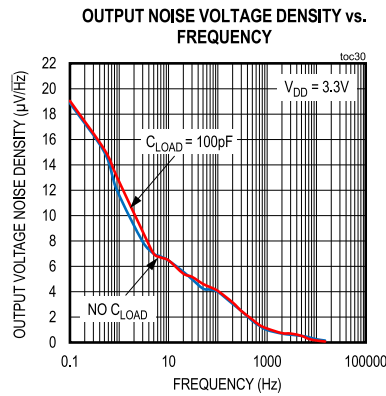
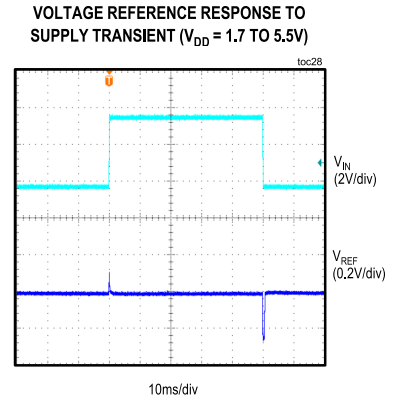
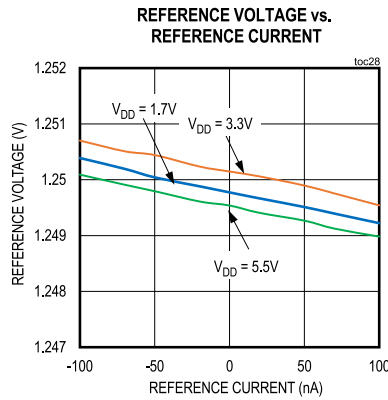
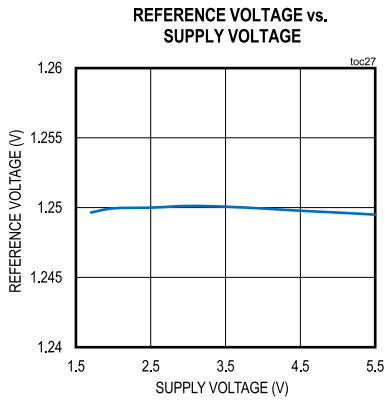

Pin Configuration

8 TDFN

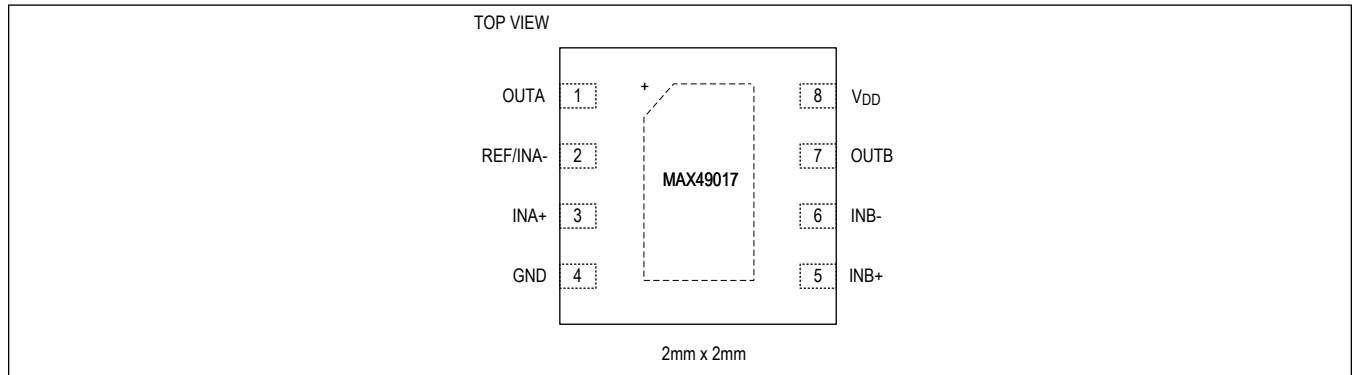

Pin Description

PIN	NAME	FUNCTION
1	OUTA	Comparator A Output
2	REF/INA-	Internal Reference Output. Internally connected to the inverting input of comparator A. Bypass REF pin with a 0.1 μ F capacitor to GND as close as possible to the device.
3	INA+	Comparator A Noninverting Input
4	GND	Ground
5	INB+	Comparator B Noninverting Input
6	INB-	Comparator B Inverting Input. A 3.3nF capacitor is optional to be added at INB-.
7	OUTB	Comparator B Output
8	V _{DD}	V _{DD} Supply Voltage. Bypass V _{DD} with a 0.1 μ F capacitor to GND as close as possible to the device pin.
—	EP	Exposed Pad. Connect EP to GND.

Detailed Description

The MAX49017 features a built-in 1.252V reference that is factory-trimmed to an initial accuracy of 1% and better than 2.5% over the entire temperature range. The common-mode voltage range of this family extends 200mV beyond the rails, allowing signals slightly beyond the rails to trigger the comparator. The 2.5mV internal hysteresis ensures clean output switching even with slow moving input signals. Large internal output drivers allow rail-to-rail output swing with up to ± 2 mA loads.

The output stage employs a unique design that minimizes supply current surges while switching, virtually eliminating supply glitches typical of many other comparators. The MAX49017 has a push-pull output stage that sinks as well as sources current.

Input Stage Circuitry

The input common-mode voltage range extends from -0.2 V to $V_{DD} + 0.2$ V. The comparator operates at any differential input voltage within these limits. Input bias current is typically ± 1 nA if the input voltage is between the supply rails. Comparator inputs are protected from overvoltage by internal ESD-protection diodes connected to the supply rails. As the input voltage exceeds the supply rails, these ESD-protection diodes become forward biased and begin to conduct increasing input bias current (see the *Input Bias Current vs. Input Common-Mode Voltage* and *Input Bias Current vs. Input Differential Voltage* graphs in the [Typical Operating Characteristics](#) section).

Output Stage Structure

The device contains a unique break-before-make output stage capable of rail-to-rail operation with up to ± 2 mA loads. Many comparators consume orders of magnitude more current during switching than during steady-state operation. In the Typical Operating Characteristics section, the *Supply Current vs. Output Transition Frequency* graphs show the minimal supply-current increase as the output switching frequency approaches 1kHz. This characteristic reduces the need for power-supply filter capacitors to reduce glitches created by comparator switching currents. In automotive applications, this characteristic results in a substantial increase in car battery life.

Voltage Reference

The MAX49017 comes with an internal voltage reference that has initial accuracy of ± 1 %. The device's internal reference has a typical temperature coefficient of 15ppm/ $^{\circ}$ C over the full -40° C to $+125^{\circ}$ C temperature range. The reference is a very-low-power bandgap cell, with a maximum 10k Ω output impedance. The REF pin can source and sink up to 100nA to external circuitry. For applications that need increased drive, buffer REF with a low input-bias current op amp such as the MAX44265. The internal reference voltage of the MAX49017 is stable with a capacitive load of 0pF to 100pF and values greater than 0.1 μ F (with an unstable region from 100pF to 0.1 μ F). To minimize unwanted feedback from pin OUTA to the REF pin through package parasitics, an 0.1 μ F bypass capacitor is recommended to be added on the REF pin.

Applications Information

Internal Hysteresis

Many comparators oscillate in the linear region of operation because of noise or undesired parasitic feedback. This tends to occur when the voltage on one input is equal or very close to the voltage on the other input. The MAX49017 has internal 2.5mV hysteresis to counter parasitic effects and noise.

The hysteresis in a comparator creates two trip points: one for upper threshold (V_{TRIP+}) and one for lower threshold (V_{TRIP-}) for voltage transitions on the input signal (Figure 1). The difference between the trip points is the hysteresis band (V_{HYS}). When the comparator's input voltages are equal, the hysteresis effectively causes one comparator input to move quickly past the other, thus taking the input out of the region where oscillation occurs. Figure 1 illustrates the case in which IN_- has a fixed voltage applied, and IN_+ is varied. If the inputs were reversed, the figure would be the same, except with an inverted output.

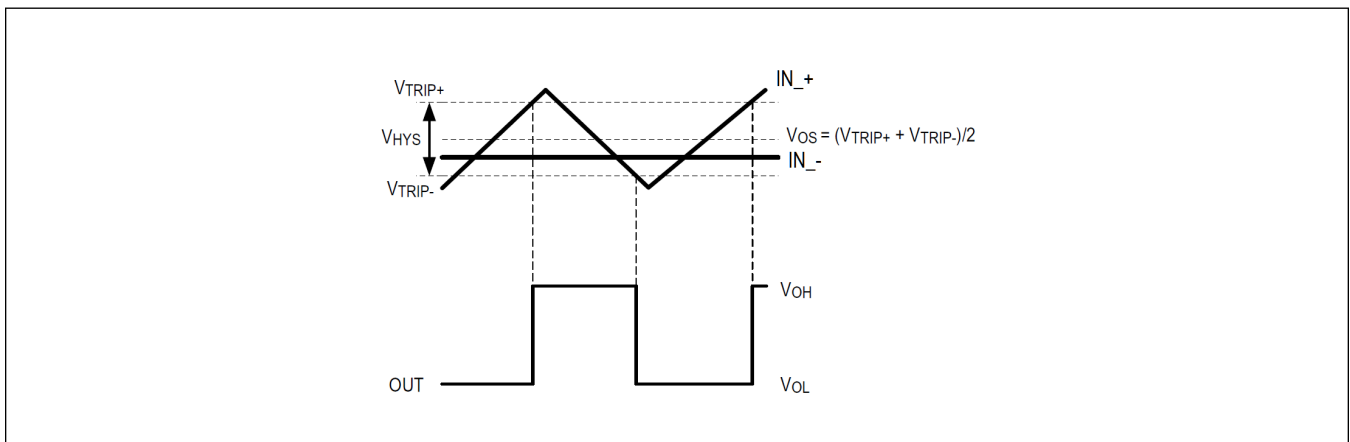

Figure 1. Hysteresis Band

Adding External Hysteresis

In applications requiring more than the internal 2.5mV hysteresis of the devices, additional hysteresis can be added with two external resistors. Since these comparators are intended to use in very low-power systems, care must be taken to minimize power dissipation in the additional circuitry.

Regardless of which approach is employed to add external hysteresis, the external hysteresis will be V_{DD} dependent. Figure 2 shows the simplest circuit for adding external hysteresis. In this example, the hysteresis is defined by:

$$\text{Hysteresis} = \frac{R_G}{R_F} \times V_{DD}$$

Where R_G is the source resistance and R_F is the feedback resistance. The comparison threshold is V_{REF} .

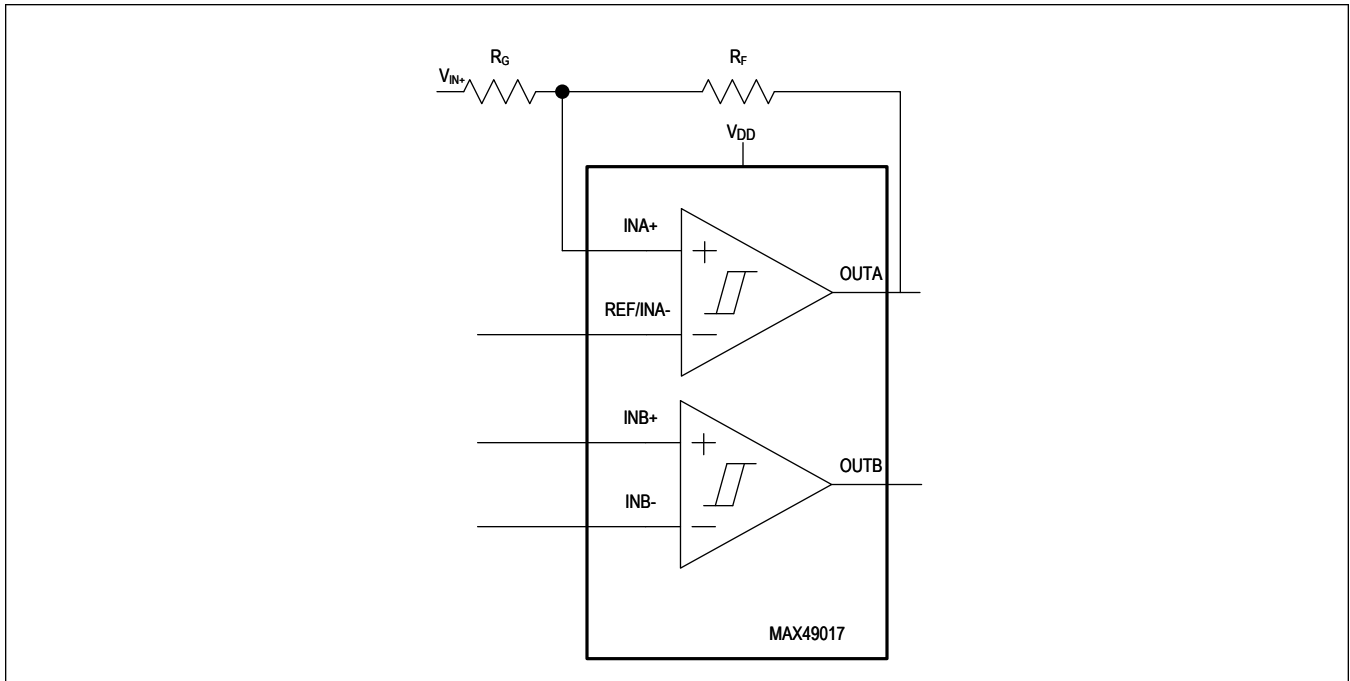

Figure 2. External Hysteresis on MAX49017

Component Selection

Because the MAX49017 is intended for very low power-supply systems, the highest impedance circuits should be used wherever possible. The offset error due to input-bias current is proportional to the total impedance seen at the input. For example, selecting components for [Figure 2](#), with a target of 50mV hysteresis, a 5V supply, and choosing an R_F of 10MΩ gives R_G as 100kΩ. The total impedance seen at IN+ is therefore 10MΩ || 100kΩ, or 99kΩ. The typical input bias current of MAX49017 is 2nA; therefore, the error due to source impedance is less than 200μV.

Board Layout and Bypassing

Power-supply bypass capacitors are not typically needed, but use 100nF bypass capacitors close to the device’s supply pins when supply impedance is high, supply leads are long, or excessive noise is expected on the supply lines. Minimize signal trace lengths to reduce stray capacitance. A ground plane and surface-mount components are recommended. If the REF pin is decoupled, use a new low-leakage capacitor.

Window Detector

The MAX49017 is ideal for window detectors (undervoltage/overvoltage detectors). The [Typical Application Circuit](#) shows how a window detector circuit can detect the related car battery’s voltage level with an undervoltage of 2.9V and an overvoltage of 4.2V. Choose different thresholds by changing the values of R1, R2, and R3. OUTA provides an active-low undervoltage indication, and OUTB provides an active-low overvoltage indication.

Design Procedure

1. Select R1. The input bias current into INB- is normally less than 5nA, so the current through R1 should exceed 250nA for the thresholds to be accurate. In this example, choose R1 = 0.25MΩ (1.252V/5μA).
2. Calculate R2 + R3. The overvoltage threshold should be 4.2V when V_{IN} is rising. The design equation is as follows:

$$R2 + R3 = R1 \times \left[\left[\frac{V_{OTH}}{V_{REF} + V_{HYS}} \right] - 1 \right] = 250k\Omega \times \left[\left[\frac{4.2V}{1.252V + 0.0025V} \right] - 1 \right] = 0.587M\Omega$$

3. Calculate R2. The undervoltage threshold should be 2.9V when V_{IN} is falling. The design equation is as follows:

$$R2 = (R1 + R2 + R3) \times \left(\frac{V_{REF} - V_{HYS}}{V_{UTH}} \right) - R1 = 0.837M\Omega \times \left(\frac{1.252V - 0.0025V}{2.9V} \right) - 0.25M\Omega = 0.111M\Omega$$

4. Calculate R3:

$$R3 = (R2 + R3) - R2 = 0.587M\Omega - 0.111M\Omega = 0.476M\Omega$$

5. Choose standard 1% resistors for $R1 = 249k\Omega$, $R2 = 110k\Omega$, and $R3 = 475k\Omega$.

6. Verify the resistor values. The equations are as follows, evaluated for the above example.

Overvoltage threshold:

$$V_{OTH} = (V_{REF} + V_{HYS}) \times \frac{(R1 + R2 + R3)}{R1} = 4.20V$$

Undervoltage threshold:

$$V_{UTH} = (V_{REF} - V_{HYS}) \times \frac{(R1 + R2 + R3)}{(R1 + R2)} = 2.897V$$

where the internal hysteresis band, V_{HB} , is 2.5mV.

Typical Application Circuit

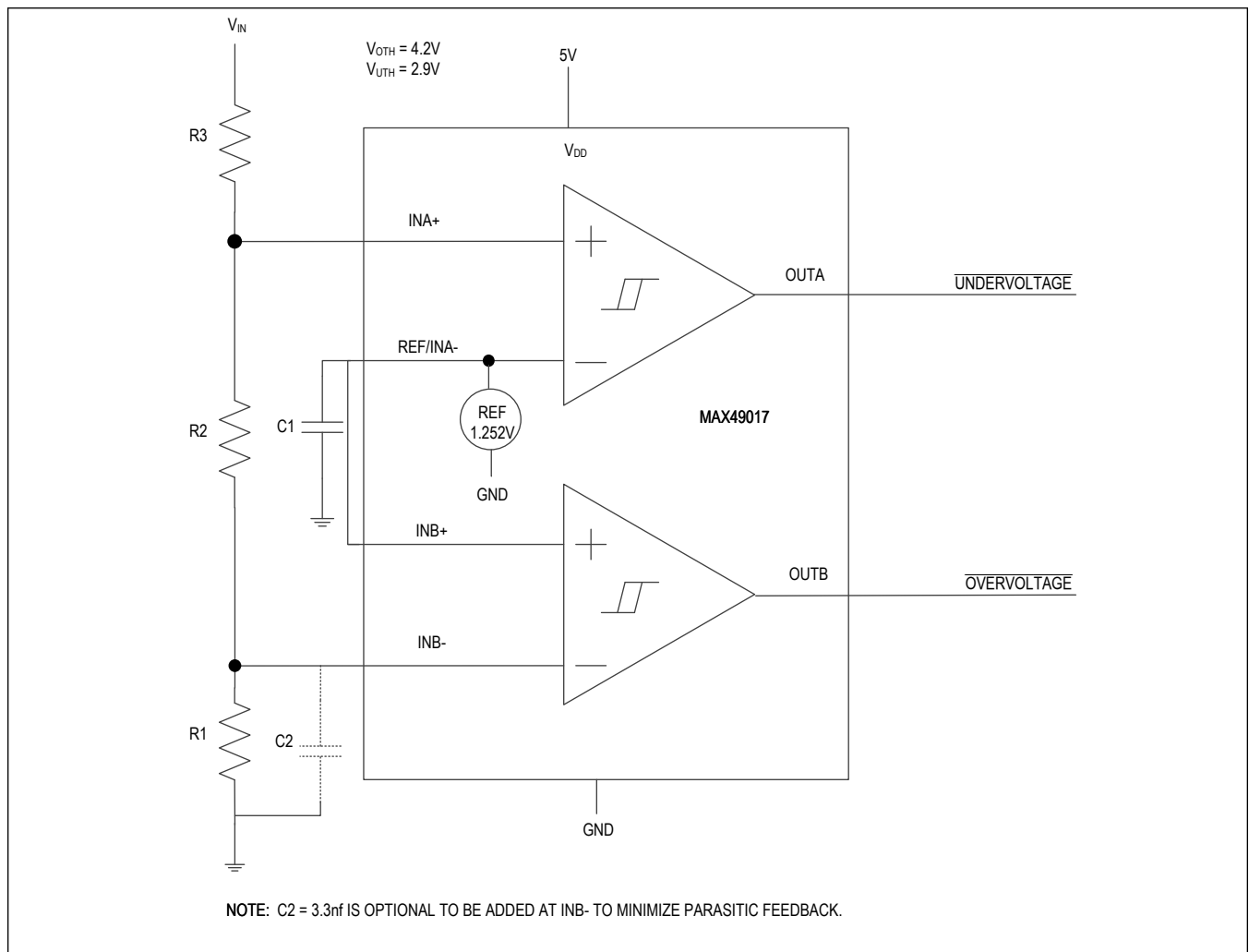

MAX49017

1.7V, Dual microPower Comparator
with Built-In Reference

Ordering Information

PART NUMBER	TEMPERATURE RANGE	PIN-PACKAGE	TOP MARK
MAX49017ATA/VY+T	-40°C to +125°C	8 TDFN (SW EP)	BSX

+Denotes a lead(Pb)-free/RoHS-compliant package.

T = Tape and reel.

/V Denotes an automotive qualified part.

SW = Side-wettable package.

EP = Exposed pad.