



[Evaluation Kit Available](#)



[Design Resources](#)



[Tools and Models](#)



[Support](#)

Click [here](#) to ask an associate for production status of specific part numbers.

IEEE 802.3af/at-Compliant, Powered Device Interface Controllers with Integrated 70W High-Power MOSFET

MAX5982A/MAX5982B/ MAX5982C

General Description

The MAX5982A/MAX5982B/MAX5982C provide a complete interface for a powered device (PD) to comply with the IEEE® 802.3af/at standard in a power-over-Ethernet (PoE) system. The MAX5982A/MAX5982B/MAX5982C provide the PD with a detection signature, classification signature, and an integrated isolation power switch with inrush current control. During the inrush period, the MAX5982A/MAX5982B/MAX5982C limit the current to less than 182mA before switching to the higher current limit (1700mA to 2100mA) when the isolation power MOSFET is fully enhanced. The devices feature an input UVLO with wide hysteresis and long deglitch time to compensate for twisted-pair cable resistive drop and to assure glitch-free transition during power-on/-off conditions. The MAX5982A/MAX5982B/MAX5982C can withstand up to 100V at the input.

The MAX5982A/MAX5982B/MAX5982C support a 2-Event classification method as specified in the IEEE 802.3at standard and provide a signal to indicate when probed by a Type 2 power sourcing equipment (PSE). The devices detect the presence of a wall adapter power source connection and allow a smooth switchover from the PoE power source to the wall power adapter.

The MAX5982A/MAX5982B/MAX5982C also provide a power-good (PG) signal, two-step current limit and fold-back, overtemperature protection, and di/dt limit. A sleep mode feature in the MAX5982A/MAX5982B provides low power consumption while supporting Maintain Power Signature (MPS). An ultra-low-power sleep mode feature in the MAX5982A/MAX5982B further reduces power consumption while still supporting MPS. The MAX5982A/MAX5982B also feature an LED driver that is automatically activated during sleep mode.

The MAX5982A/MAX5982B/MAX5982C are available in a 16-pin, 5mm x 5mm, TQFN power package. These devices are rated over the -40°C to +85°C and -40°C to +125°C extended temperature ranges.

Features

- Sleep Mode and Ultra-Low-Power Sleep (MAX5982A/MAX5982B)
- IEEE 802.3af/at Compliant
- 2-Event Classification or an External Wall Adapter Indicator Output
- Simplified Wall Adapter Interface
- PoE Classification 0–5
- 100V Input Absolute Maximum Rating
- Inrush Current Limit of 182mA Maximum
- Current Limit During Normal Operation Between 1700mA and 2100mA
- Current Limit and Foldback
- Legacy UVLO at 36V
- LED Driver with Programmable LED Current (MAX5982A/MAX5982B)
- Overtemperature Protection
- Thermally Enhanced, 5mm x 5mm, 16-Pin TQFN

Applications

- IEEE 802.3af/at Powered Devices
- IP Phones, Wireless Access Nodes, IP Security Cameras
- WiMAX™ Base Stations

[Ordering Information](#) appears at end of data sheet.

WiMAX is a trademark of WiMAX Forum.

IEEE is a registered service mark of the Institute of Electrical and Electronics Engineers, Inc.

19-5960; Rev 4; 11/21

MAX5982A/MAX5982B/ MAX5982C

IEEE 802.3af/at-Compliant, Powered Device Interface Controllers with Integrated 70W High-Power MOSFET

Absolute Maximum Ratings

V _{DD} to V _{SS}	-0.3V to +100V	Operating Temperature Range.....	-40°C to +125°C
DET, RTN, WAD, PG, $\overline{2EC}$ to V _{SS}	-0.3V to +100V	Maximum Junction Temperature	+150°C
CLS, \overline{SL} , \overline{WK} , \overline{ULP} , LED to V _{SS}	-0.3V to +6V	Storage Temperature Range.....	-65°C to +150°C
Maximum Current on CLS (100ms maximum).....	100mA	Lead Temperature (soldering, 10s)	+300°C
Continuous Power Dissipation (T _A = +70°C) (Note 1)		Soldering Temperature (reflow).....	+260°C
TQFN (derate 28.6mW/°C above +70°C)			
Multilayer Board.....	2285.7mW		

Stresses beyond those listed under "Absolute Maximum Ratings" may cause permanent damage to the device. These are stress ratings only, and functional operation of the device at these or any other conditions beyond those indicated in the operational sections of the specifications is not implied. Exposure to absolute maximum rating conditions for extended periods may affect device reliability.

Note 1: Maximum power dissipation is obtained using JEDEC JESD51-5 and JESD51-7 specifications.

Package Thermal Characteristics (Note 2)

TQFN

Junction-to-Ambient Thermal Resistance (θ_{JA})	35°C/W
Junction-to-Case Thermal Resistance (θ_{JC}).....	2.7°C/W

Note 2: Package thermal resistances were obtained using the method described in JEDEC specification JESD51-7, using a four-layer board. For detailed information on package thermal considerations, refer to www.maximintegrated.com/thermal-tutorial.

Electrical Characteristics

(V_{IN} = (V_{DD} - V_{SS}) = 48V, R_{DET} = 24.9k Ω , R_{CLS} = 615 Ω , and R_{SL} = 60.4k Ω . RTN, WAD, PG, $\overline{2EC}$, \overline{WK} , and \overline{ULP} unconnected, all voltages are referenced to V_{SS}, unless otherwise noted. T_A = T_J = -40°C to +85°C (MAX5982AETE/BETE/CETE), T_A = T_J = -40°C to +125°C (MAX5982AATE/BATE/CATE), unless otherwise noted. Typical values are at T_A = +25°C.) (Note 3)

PARAMETER	SYMBOL	CONDITIONS	MIN	TYP	MAX	UNITS	
DETECTION MODE							
Input Offset Current	I _{OFFSET}	V _{IN} = 1.4V to 10.1V (Note 4)			10	μ A	
Effective Differential Input Resistance	dR	V _{IN} = 1.4V up to 10.1V with 1V step, V _{DD} = RTN = WAD = PG = $\overline{2EC}$ (Note 5)	23.95	25.00	25.50	k Ω	
CLASSIFICATION MODE							
Classification Disable Threshold	V _{TH,CLS}	V _{IN} rising (Note 6)	22.0	22.8	23.6	V	
Classification Stability Time				0.2		ms	
Classification Current	I _{CLASS}	V _{IN} = 12.5V to 20.5V, V _{DD} = RTN = WAD = PG = $\overline{2EC}$	Class 0, R _{CLS} = 615 Ω	0		3.96	mA
			Class 1, R _{CLS} = 117 Ω	9.12		11.88	
			Class 2, R _{CLS} = 66.5 Ω	17.2		19.8	
			Class 3, R _{CLS} = 43.7 Ω	26.3		29.7	
			Class 4, R _{CLS} = 30.9 Ω	36.4		43.6	
			Class 5, R _{CLS} = 21.3 Ω	52.7		63.3	
TYPE 2 (802.3at) CLASSIFICATION MODE							
Mark Event Threshold	V _{THM}	V _{IN} falling	10.1	10.7	11.6	V	
Hysteresis on Mark Event Threshold				0.82		V	
Mark Event Current	I _{MARK}	V _{IN} falling to enter mark event, 5.2V \leq V _{IN} \leq 10.1V	0.25		0.85	mA	
Reset Event Threshold	V _{THR}	V _{IN} falling	-40°C to +125°C	2.7	3.8	5.2	V
			-40°C to +85°C	2.8	3.8	5.2	

MAX5982A/MAX5982B/ MAX5982C

IEEE 802.3af/at-Compliant, Powered Device Interface Controllers with Integrated 70W High-Power MOSFET

Electrical Characteristics (continued)

($V_{IN} = (V_{DD} - V_{SS}) = 48V$, $R_{DET} = 24.9k\Omega$, $R_{CLS} = 615\Omega$, and $R_{SL} = 60.4k\Omega$. RTN, WAD, PG, $\overline{2EC}$, \overline{WK} , and \overline{ULP} unconnected, all voltages are referenced to V_{SS} , unless otherwise noted. $T_A = T_J = -40^\circ C$ to $+85^\circ C$ (MAX5982AETE/BETE/CETE), $T_A = T_J = -40^\circ C$ to $+125^\circ C$ (MAX5982AATE/BATE/CATE), unless otherwise noted. Typical values are at $T_A = +25^\circ C$.) (Note 3)

PARAMETER	SYMBOL	CONDITIONS	MIN	TYP	MAX	UNITS	
POWER MODE							
V_{IN} Supply Voltage Range					60	V	
V_{IN} Supply Current	I_Q	Current through internal MOSFET = 0		0.25	0.55	mA	
V_{IN} Turn-On Voltage	V_{ON}	V_{IN} rising	34.3	35.4	36.6	V	
V_{IN} Turn-Off Voltage	V_{OFF}	V_{IN} falling	30			V	
V_{IN} Turn-On/-Off Hysteresis	V_{HYST_UVLO}	(Note 7)	4.2			V	
V_{IN} Deglitch Time	t_{OFF_DLY}	V_{IN} falling from 40V to 20V (Note 8)	30	120		μs	
Inrush to Operating Mode Delay	t_{DELAY}	t_{DELAY} = minimum PG current pulse width after entering into power mode	90	96	102	ms	
Isolation Power MOSFET On-Resistance	R_{ON_ISO}	$I_{RTN} = 950mA$	$T_J = +25^\circ C$	0.1	0.2	Ω	
			$T_J = +85^\circ C$	0.15	0.25		
			$T_J = +125^\circ C$	0.2			
RTN Leakage Current	I_{RTN_LKG}	$V_{RTN} = 12.5V$ to 30V			10	μA	
CURRENT LIMIT							
Inrush Current Limit	I_{INRUSH}	During initial turn-on period, $V_{RTN} = 1.5V$	90	135	182	mA	
Current Limit During Normal Operation	I_{LIM}	After inrush completed, $V_{RTN} = 1V$ (Note 9)	$-40^\circ C$ to $+85^\circ C$	1700	1900	2100	mA
			$-40^\circ C$ to $+125^\circ C$	1650	1900	2150	
Current Limit in Foldback Condition	$I_{LIM-FLDBK}$	Both during inrush and after inrush completed $V_{RTN} = 7.5V$		53		mA	
Foldback Threshold		V_{RTN} (Note 10)	6.5	7.0	7.5	V	
LOGIC							
WAD Detection Threshold	$V_{WAD-REF}$	V_{WAD} rising, $V_{IN} = 14V$ to 48V (referenced to RTN)	8	9	10	V	
WAD Detection Threshold Hysteresis		V_{WAD} falling, $V_{RTN} = 0V$, V_{SS} unconnected		0.35		V	
WAD Input Current	$I_{WAD-LKG}$	$V_{WAD} = 10V$ (referenced to RTN)			3.5	μA	
$\overline{2EC}$ Sink Current		$V_{\overline{2EC}} = 3.5V$ (referenced to RTN), V_{SS} disconnected	1	1.5	2.25	mA	
$\overline{2EC}$ Off-Leakage Current		$V_{\overline{2EC}} = 48V$			1	μA	
PG Sink Current		$V_{RTN} = 1.5V$, $V_{PG} = 0.8V$, during inrush period	125	230	375	μA	
PG Off-Leakage Current		$V_{PG} = 60V$			1	μA	
SLEEP MODE (MAX5982A/MAX5982B)							
\overline{WK} and \overline{ULP} Logic Threshold	V_{TH}	$V_{\overline{WK}}$ falling and $V_{\overline{ULP}}$ rising and falling	1.5		3	V	
\overline{SL} Logic Threshold		Falling	0.75	0.8	0.85	V	
\overline{SL} Current		$R_{SL} = 0\Omega$		140		μA	
LED Current Amplitude	I_{LED}	$R_{SL} = 60.4k\Omega$, $V_{LED} = 3.5V$	10	10.5	11.5	mA	
		$R_{SL} = 30.2k\Omega$, $V_{LED} = 3.75V$	19.5	20.9	22.5		
		$R_{SL} = 30.2k\Omega$, $V_{LED} = 4V$	19				

Electrical Characteristics (continued)

($V_{IN} = (V_{DD} - V_{SS}) = 48V$, $R_{DET} = 24.9k\Omega$, $R_{CLS} = 615\Omega$, and $R_{SL} = 60.4k\Omega$. RTN, WAD, PG, $\overline{2EC}$, \overline{WK} , and \overline{ULP} unconnected, all voltages are referenced to V_{SS} , unless otherwise noted. $T_A = T_J = -40^\circ C$ to $+85^\circ C$ (MAX5982AETE/BETE/CETE), $T_A = T_J = -40^\circ C$ to $+125^\circ C$ (MAX5982AATE/BATE/CATE), unless otherwise noted. Typical values are at $T_A = +25^\circ C$.) (Note 3)

PARAMETER	SYMBOL	CONDITIONS	MIN	TYP	MAX	UNITS	
LED Current Programmable Range			10		20	mA	
LED Current with Grounded \overline{SL}		$V_{\overline{SL}} = 0V$	20.5	24.5	28.5	mA	
LED Current Frequency	f_{ILED}	Normal and ultra-low-power sleep modes		250		Hz	
LED Current Duty Cycle	D_{ILED}	Normal and ultra-low-power sleep modes		25		%	
V_{DD} Current Amplitude	I_{VDD}	Normal sleep mode, $V_{LED} = 3.5V$	10	11	12.2	mA	
Internal Current Duty Cycle	D_{IVDD}	Normal and ultra-low-power sleep modes		75		%	
Internal Current Enable Time	t_{MPS}	Ultra-low-power sleep mode	-40°C to +85°C	80	84	88	ms
			-40°C to +125°C	80	84	90	
Internal Current Disable Time	t_{MPDO}	Ultra-low-power sleep mode	-40°C to +125°C	217	228	240	ms
			-40°C to +85°C	220	228	236	
\overline{SL} Delay Time	$t_{\overline{SL}}$	Time $V_{\overline{SL}}$ must remain below the \overline{SL} logic threshold to enter sleep and ultra-low-power modes (MAX5982A)	5.4	6.0	6.6	s	
THERMAL SHUTDOWN							
Thermal-Shutdown Threshold	T_{SD}	T_J rising		+150		°C	
Thermal-Shutdown Hysteresis		T_J falling		30		°C	

- Note 3:** All devices are 100% production tested at $T_A = +25^\circ C$. Limits over temperature are guaranteed by design.
- Note 4:** The input offset current is illustrated in Figure 1.
- Note 5:** Effective differential input resistance is defined as the differential resistance between V_{DD} and V_{SS} . See Figure 1.
- Note 6:** Classification current is turned off whenever the device is in power mode.
- Note 7:** UVLO hysteresis is guaranteed by design, not production tested.
- Note 8:** A 20V glitch on input voltage, which takes V_{DD} below V_{ON} shorter than or equal to t_{OFF_DLY} does not cause the MAX5982A/MAX5982B/MAX5982C to exit power-on mode.
- Note 9:** Maximum current limit during normal operation is guaranteed by design; not production tested.
- Note 10:** In power mode, current-limit foldback is used to reduce the power dissipation in the isolation MOSFET during an overload condition across V_{DD} and RTN.

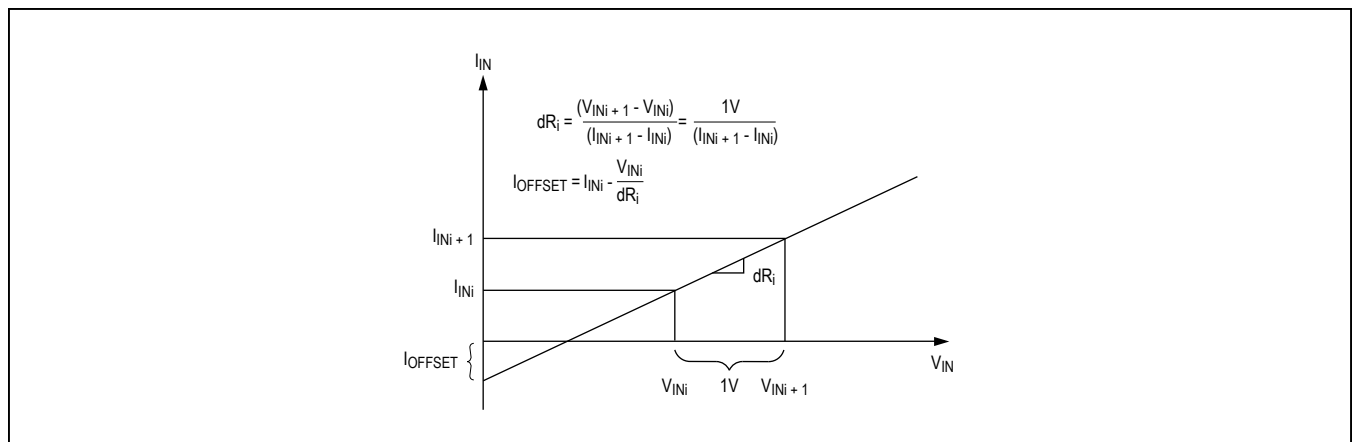
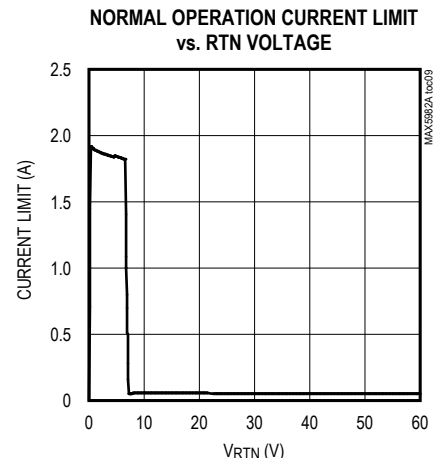
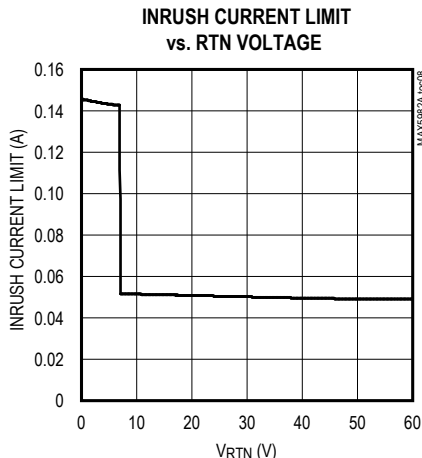
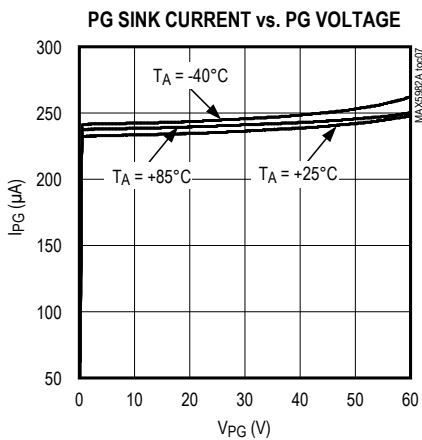
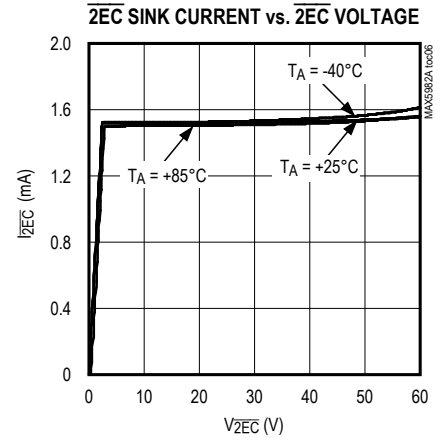
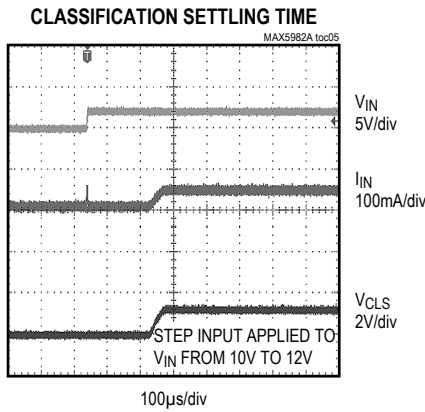
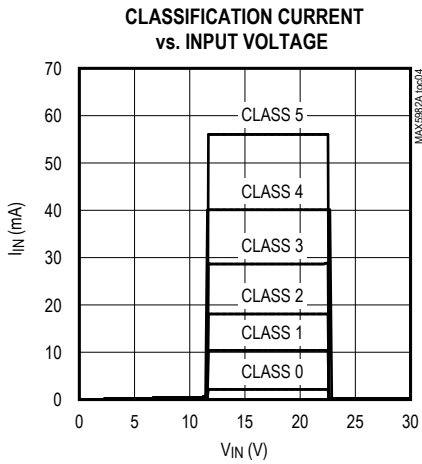
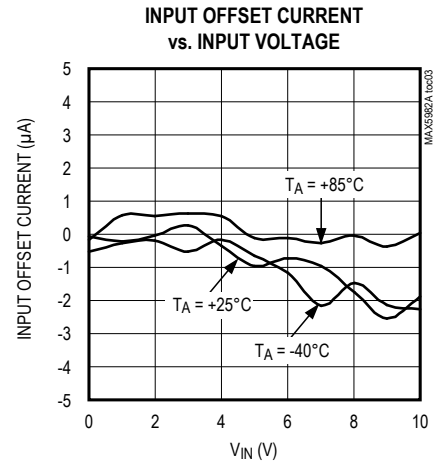
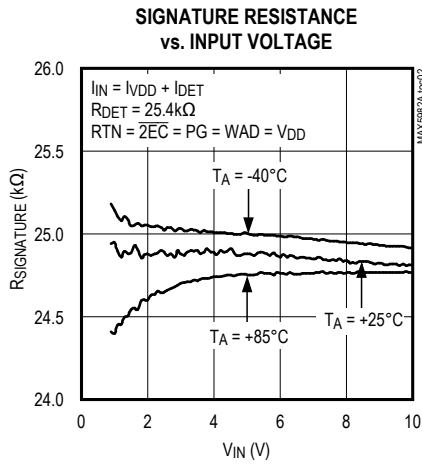
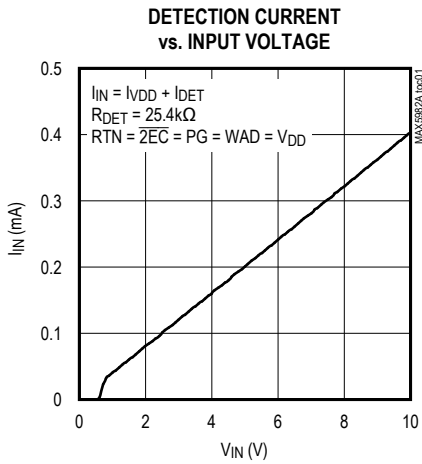

Figure 1. Effective Differential Input Resistance/Offset Current

Typical Operating Characteristics

($V_{IN} = (V_{DD} - V_{SS}) = 54V$, $R_{DET} = 24.9k\Omega$, $R_{CLS} = 615\Omega$, and $R_{SL} = 60.4k\Omega$. R_{TN} , WAD , PG , $\overline{2EC}$, \overline{WK} , and \overline{ULP} unconnected; all voltages are referenced to V_{SS} .)



MAX5982A/MAX5982B/ MAX5982C

IEEE 802.3af/at-Compliant, Powered Device Interface Controllers with Integrated 70W High-Power MOSFET

Typical Operating Characteristics (continued)

($V_{IN} = (V_{DD} - V_{SS}) = 54V$, $R_{DET} = 24.9k\Omega$, $R_{CLS} = 615\Omega$, and $R_{SL} = 60.4k\Omega$. RTN , WAD , PG , $\overline{2EC}$, \overline{WK} , and \overline{ULP} unconnected; all voltages are referenced to V_{SS} .)

INRUSH CONTROL WAVEFORM
WITH TYPE 2 CLASSIFICATION

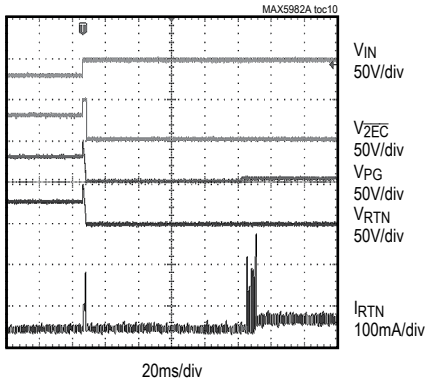

INRUSH CONTROL WAVEFORM
WITH TYPE 2 CLASSIFICATION

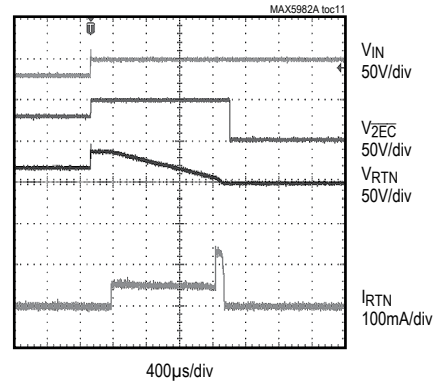

LED CURRENT vs. R_{SL}

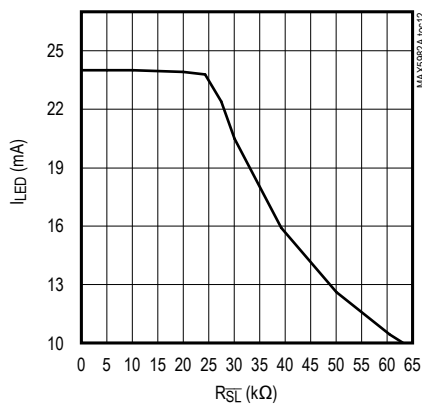

LED CURRENT vs. LED VOLTAGE

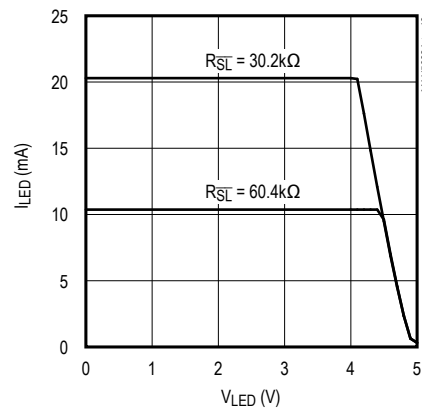

DRIVING LED WITH \overline{ULP} IN
POWER MODE

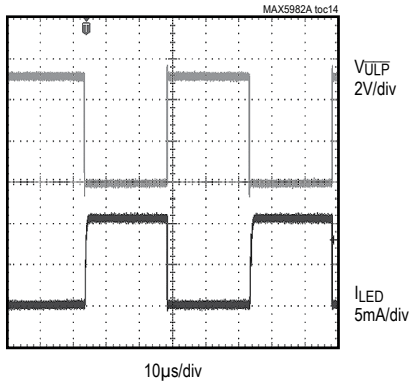

SLEEP/ULTRA-LOW-POWER MODE
DELAY (MAX5982A)

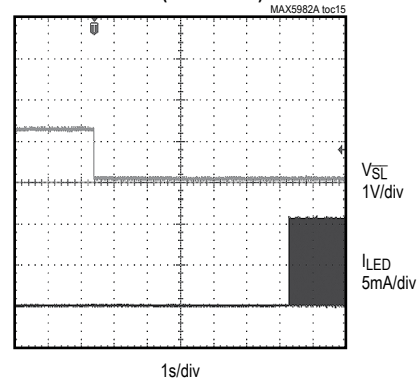

MAX5982A/MAX5982B/ MAX5982C

IEEE 802.3af/at-Compliant,
Powered Device Interface Controllers with
Integrated 70W High-Power MOSFET

Pin Configurations

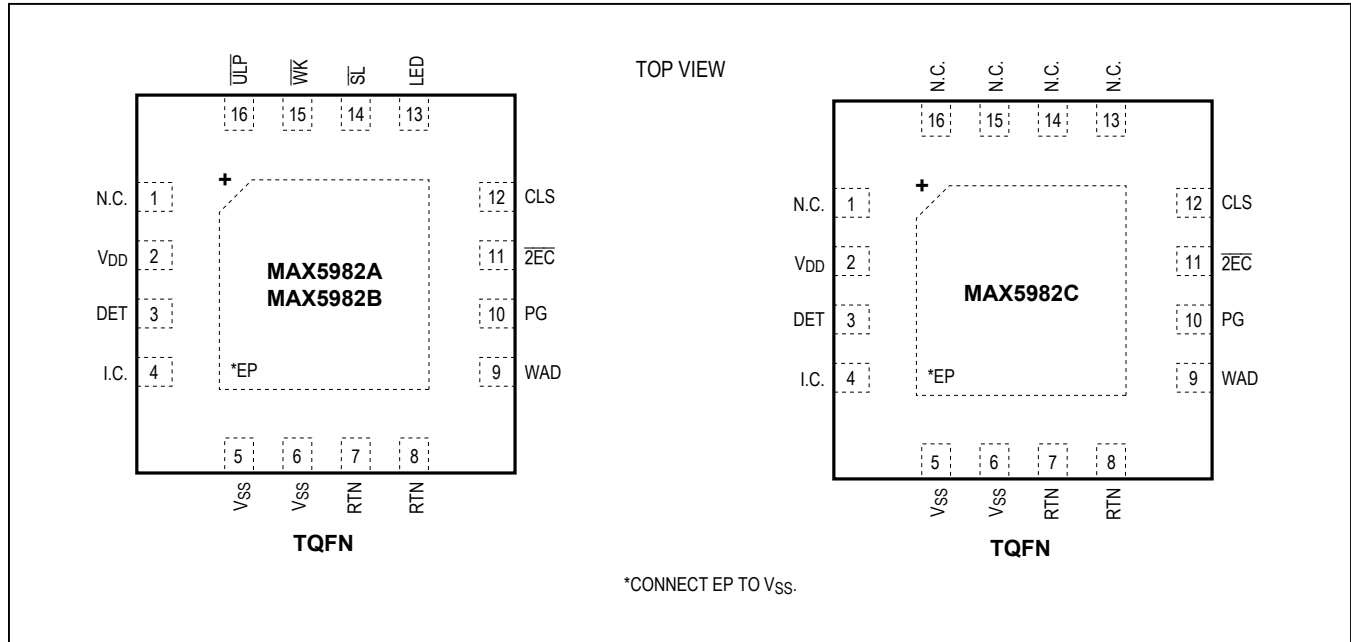

Pin Description

PIN		NAME	FUNCTION
MAX5982A/ MAX5982B	MAX5982C		
1	1, 13–16	N.C.	No Connection. Not internally connected.
2	2	V _{DD}	Positive Supply Input. Connect a 68nF (min) bypass capacitor between V _{DD} and V _{SS} .
3	3	DET	Detection Resistor Input. Connect a signature resistor (R _{DET} = 24.9kΩ) from DET to V _{DD} .
4	4	I.C.	Internally Connected. Leave unconnected.
5, 6	5, 6	V _{SS}	Negative Supply Input. V _{SS} connects to the source of the integrated isolation n-channel power MOSFET.
7, 8	7, 8	RTN	Drain of Isolation MOSFET. RTN connects to the drain of the integrated isolation n-channel power MOSFET. Connect RTN to the downstream DC-DC converter ground as shown in the <i>Typical Application Circuit</i> .
9	9	WAD	Wall Power Adapter Detector Input. Wall adapter detection is enabled the moment V _{DD} - V _{SS} crosses the mark event threshold. Detection occurs when the voltage from WAD to RTN is greater than 9V. When a wall power adapter is present, the isolation n-channel power MOSFET turns off and 2EC current sink turns on. Connect WAD directly to RTN when the wall power adapter or other auxiliary power source is not used.
10	10	PG	Open-Drain, Power-Good Indicator Output. PG sinks 230μA to disable the downstream DC-DC converter while turning on the hot-swap MOSFET switch. PG current sink is disabled during detection, classification, and in the steady-state power mode. The PG current sink is turned on to disable the downstream DC-DC converter when the device is in sleep mode.

Pin Description (continued)

PIN		NAME	FUNCTION
MAX5982A/ MAX5982B	MAX5982C		
11	11	$\overline{2EC}$	2-Event Classification Detect or Wall Adapter Detect Output. A 1.5mA current sink is enabled at $\overline{2EC}$ when a Type 2 PSE or a wall adapter is detected. When powered by a Type 2 PSE, the $\overline{2EC}$ current sink is enabled after the isolation MOSFET is fully on until V_{IN} drops below the UVLO threshold. $\overline{2EC}$ is latched when powered by a Type 2 PSE until V_{IN} drops below the reset threshold. $\overline{2EC}$ also asserts when a wall adapter supply, typically greater than 9V, is applied between WAD and RTN. $\overline{2EC}$ is not latched if asserted by WAD. The $\overline{2EC}$ current sink is turned off when the device is in sleep mode.
12	12	CLS	Classification Resistor Input. Connect a resistor (R_{CLS}) from CLS to V_{SS} to set the desired classification current. See the classification current specifications in the <i>Electrical Characteristics</i> table to find the resistor value for a particular PD classification.
13	—	LED	LED Driver Output. During sleep mode, LED sources a periodic current (I_{LED}) at 250Hz with 25% duty cycle. The amplitude of I_{LED} is set by R_{SL} according to the formula I_{LED} (in A) = $645.75/(R_{SL} + 1200)$.
14	—	\overline{SL}	Sleep Mode Enable Input. In the MAX5982B, a falling edge on \overline{SL} brings the device into sleep mode ($V_{\overline{SL}}$ must drop below 0.75V). In the MAX5982A, $V_{\overline{SL}}$ must remain below the threshold (0.75V) for a period of at least 6s after falling edge to bring the device into sleep mode. An external resistor ($R_{\overline{SL}}$) connected between \overline{SL} and V_{SS} sets the LED current (I_{LED}).
15	—	\overline{WK}	Wake Mode Enable Input. \overline{WK} has an internal 2.5k Ω pullup resistor to the internal 5V bias rail. A falling edge on \overline{WK} brings the device out of sleep mode and into the normal operating mode (wake mode).
16	—	\overline{ULP}	Ultra-Low-Power Sleep Enable Input (in Sleep Mode). \overline{ULP} has an internal 50k Ω pullup resistor to the internal 5V bias rail. A falling edge on \overline{SL} in the MAX5982B (and a 6s period below the \overline{SL} threshold in the MAX5982A) while \overline{ULP} is asserted low enables ultra-low-power sleep mode. When ultra-low-power sleep mode is enabled, the power consumption of the device is reduced even lower than normal sleep mode to comply with ultra-low-power sleep power requirements while still supporting MPS.
—	—	EP	Exposed Pad. Do not use EP as an electrical connection to V_{SS} . EP is internally connected to V_{SS} through a resistive path and must be connected to V_{SS} externally. To optimize power dissipation, solder the exposed pad to a large copper power plane.

**MAX5982A/MAX5982B/
MAX5982C**

IEEE 802.3af/at-Compliant,
Powered Device Interface Controllers with
Integrated 70W High-Power MOSFET

MAX5982A/MAX5982B Simplified Block Diagram

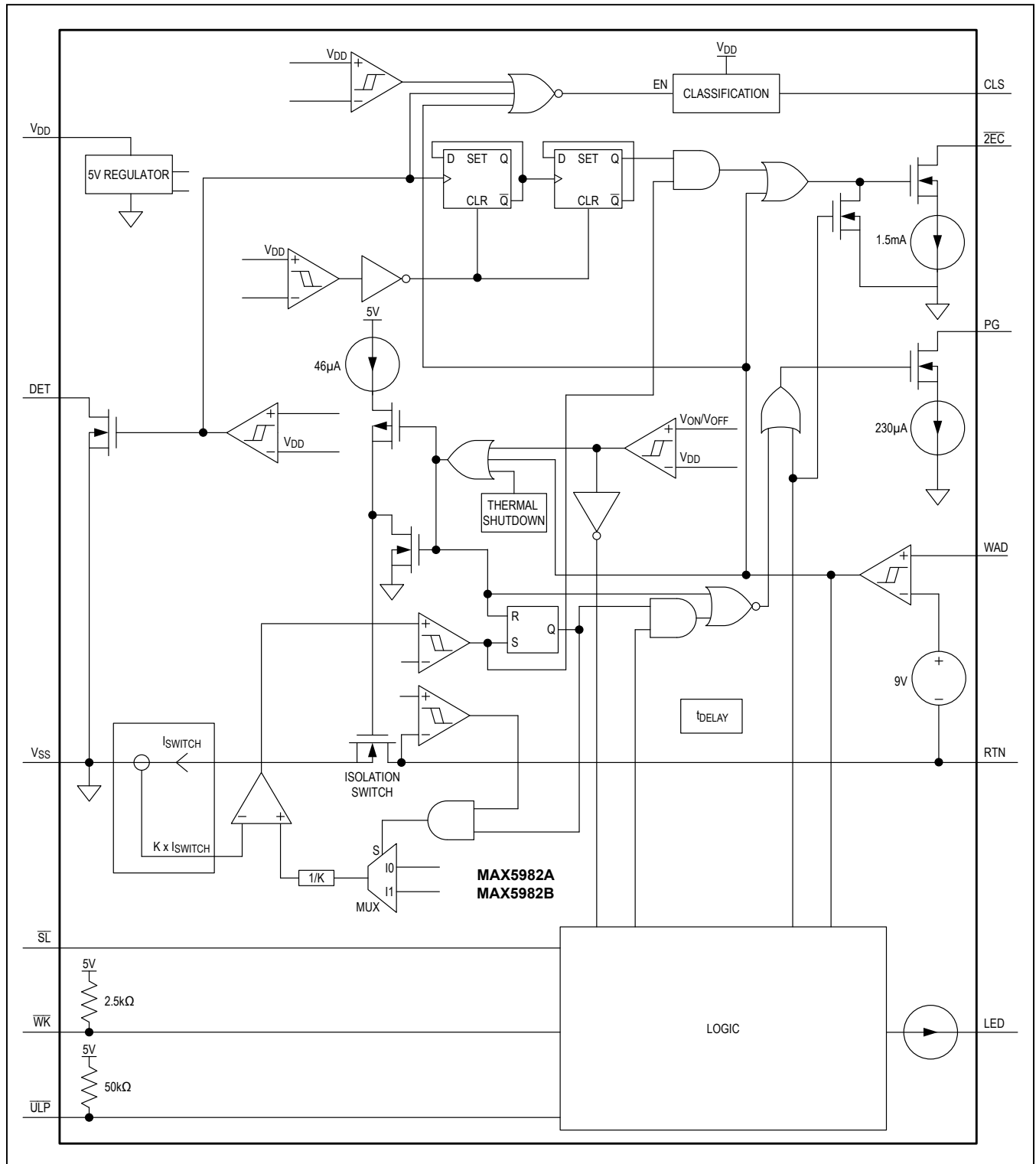

**MAX5982A/MAX5982B/
MAX5982C**

IEEE 802.3af/at-Compliant,
Powered Device Interface Controllers with
Integrated 70W High-Power MOSFET

MAX5982C Simplified Block Diagram

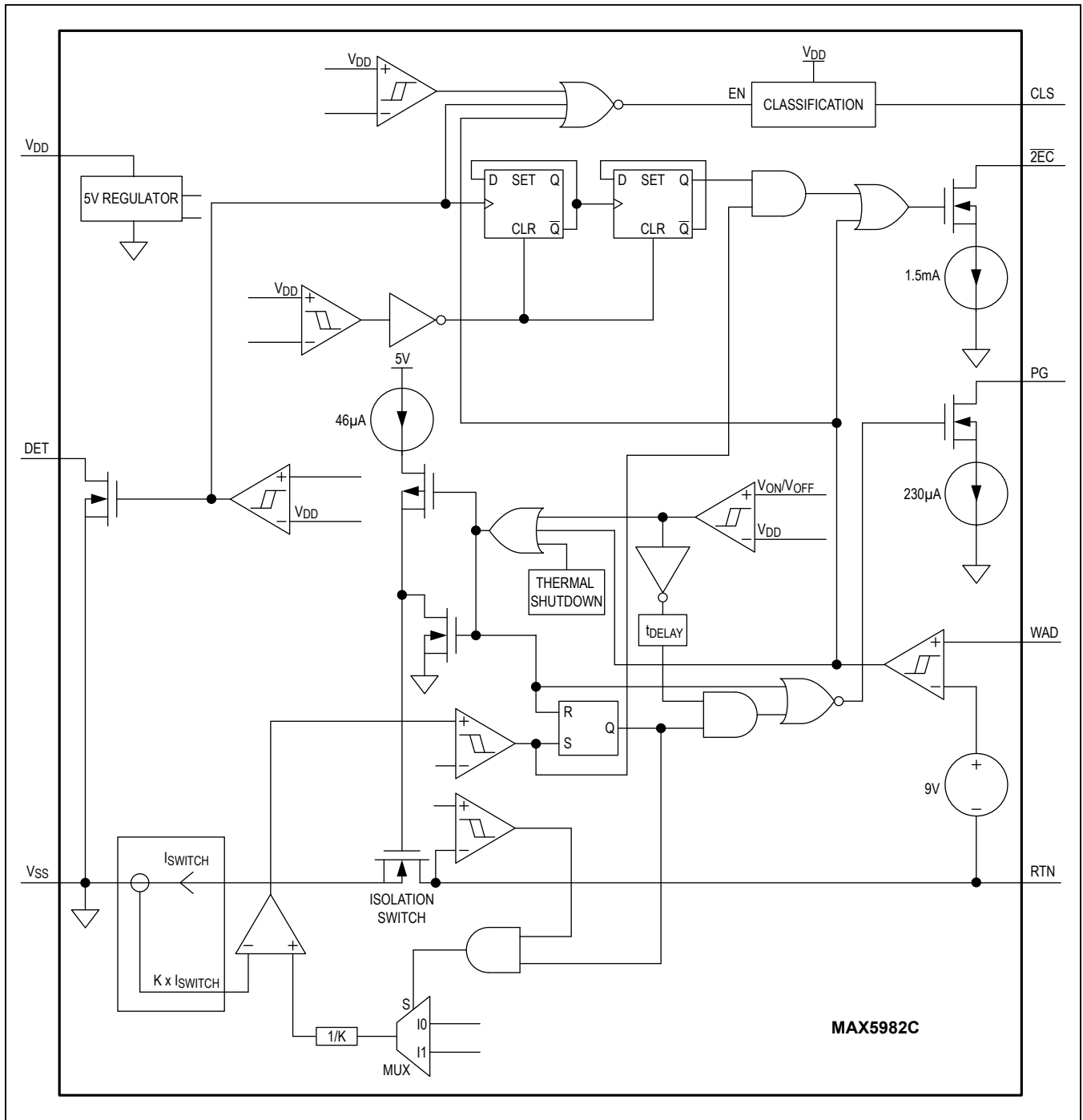

MAX5982A/MAX5982B/ MAX5982C

IEEE 802.3af/at-Compliant,
Powered Device Interface Controllers with
Integrated 70W High-Power MOSFET

Typical Operating Circuit

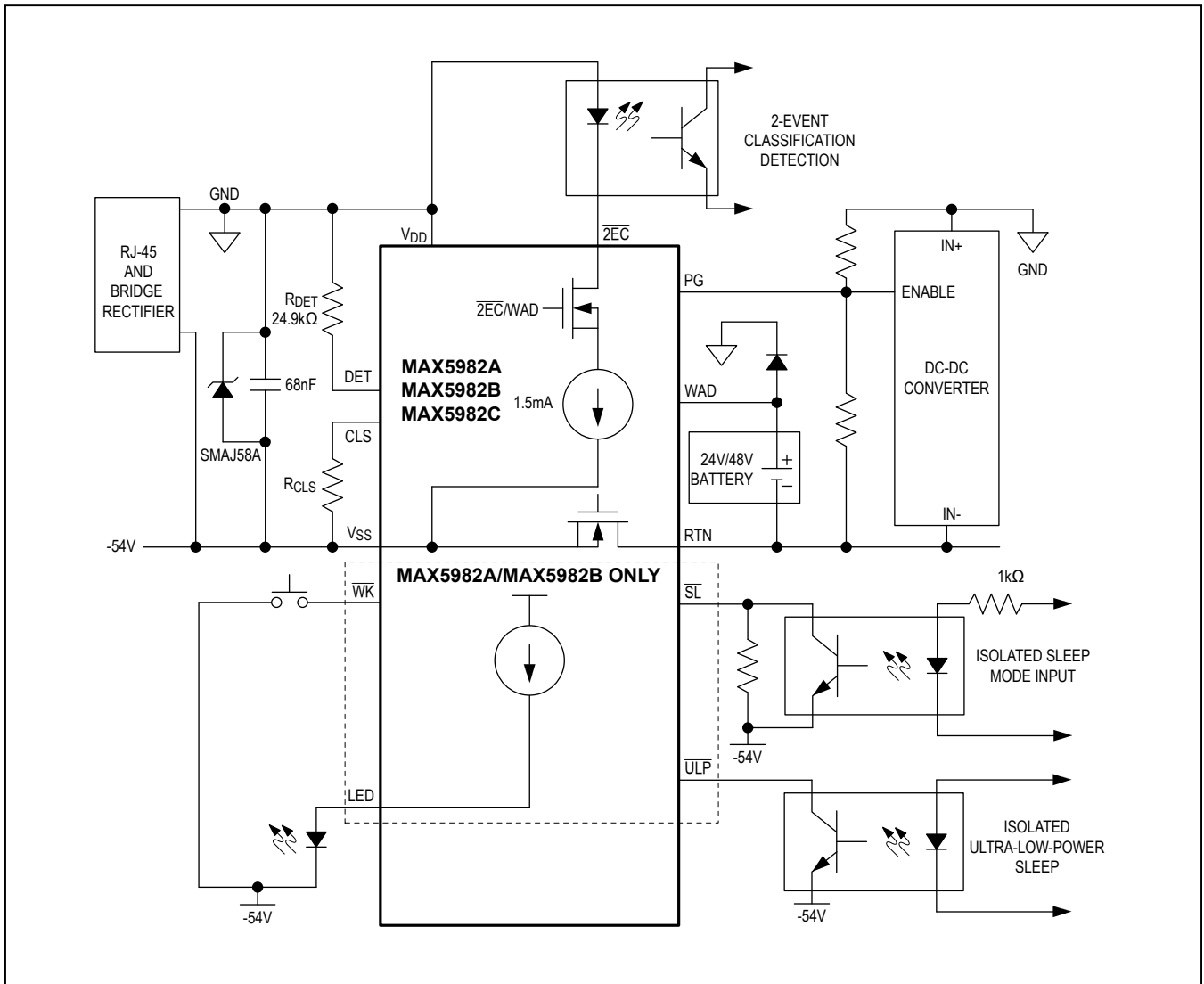

Detailed Description

Operating Modes

Depending on the input voltage ($V_{IN} = V_{DD} - V_{SS}$), the MAX5982A/MAX5982B/MAX5982C operate in four different modes: PD detection, PD classification, mark event, and PD power. The devices enter PD detection mode when the input voltage is between 1.4V and 10.1V. The device enters PD classification mode when the input voltage is between 12.6V and 20V. The devices enter PD power mode once the input voltage exceeds V_{ON} .

Detection Mode ($1.4V \leq V_{IN} \leq 10.1V$)

In detection mode, the power source equipment (PSE) applies two voltages on V_{IN} in the 1.4V to 10.1V range (1V step minimum) and then records the current measurements at the two points. The PSE then computes $\Delta V/\Delta I$ to ensure the presence of the 24.9k Ω signature resistor. Connect the signature resistor (R_{DET}) from V_{DD} to DET for proper signature detection. The MAX5982A/MAX5982B/MAX5982C pull DET low in detection mode. DET goes high impedance when the input voltage exceeds 12.5V. In detection mode, most of the MAX5982A/MAX5982B/MAX5982C internal circuitry is off and the offset current is less than 10 μ A.

If the voltage applied to the PD is reversed, install protection diodes at the input terminal to prevent internal damage to the MAX5982A/MAX5982B/MAX5982C (see the *Typical Application Circuit*). Since the PSE uses a slope technique ($\Delta V/\Delta I$) to calculate the signature resistance, the DC offset due to the protection diodes is subtracted and does not affect the detection process.

Classification Mode ($12.6V \leq V_{IN} \leq 20V$)

In the classification mode, the PSE classifies the PD based on the power consumption required by the PD. This allows

the PSE to efficiently manage power distribution. Class 0–5 is defined as shown in Table 1. (The IEEE 802.3af/at standard defines only Class 0–4 and Class 5 for any special requirement.) An external resistor (R_{CLS}) connected from CLS to V_{SS} sets the classification current.

The PSE determines the class of a PD by applying a voltage at the PD input and measuring the current sourced out of the PSE. When the PSE applies a voltage between 12.6V and 20V, the MAX5982A/MAX5982B/MAX5982C exhibit a current characteristic with a value shown in Table 1. The PSE uses the classification current information to classify the power requirement of the PD. The classification current includes the current drawn by R_{CLS} and the supply current of the MAX5982A/MAX5982B/MAX5982C so the total current drawn by the PD is within the IEEE 802.3af/at standard figures. The classification current is turned off whenever the device is in power mode.

2-Event Classification and Detection

During 2-Event classification, a Type 2 PSE probes PD for classification twice. In the first classification event, the PSE presents an input voltage between 12.6V and 20.5V and the MAX5982A/MAX5982B/MAX5982C present the programmed load I_{CLASS} . The PSE then drops the probing voltage below the mark event threshold of 10.1V and the MAX5982A/MAX5982B/MAX5982C present the mark current (I_{MARK}). This sequence is repeated one more time.

When the MAX5982A/MAX5982B/MAX5982C are powered by a Type 2 PSE, the 2-Event identification output $\overline{2EC}$ asserts low after the internal isolation n-channel MOSFET is fully turned on. $\overline{2EC}$ current sink is turned off when V_{DD} goes below the UVLO threshold (V_{OFF}) and turns on when V_{DD} goes above the UVLO threshold (V_{ON}), unless V_{DD} goes below V_{THR} to reset the latched output of the Type 2 PSE detection flag.

Table 1. Setting Classification Current

CLASS	MAXIMUM POWER USED BY PD (W)	R_{CLS} (Ω)	V_{IN}^* (V)	CLASS CURRENT SEEN AT V_{IN} (mA)		IEEE 802.3at PD CLASSIFICATION CURRENT SPECIFICATION (mA)	
				MIN	MAX	MIN	MAX
0	0.44 to 12.95	615	12.6 to 20	0	4	0	5
1	0.44 to 3.94	117	12.6 to 20	9	12	8	13
2	3.84 to 6.49	66.5	12.6 to 20	17	20	16	21
3	6.49 to 12.95	43.7	12.6 to 20	26	30	25	31
4	12.95 to 25.5	30.9	12.6 to 20	36	44	35	45
5	> 25.5w	21.3	12.6 to 20	54	64	51	68

* V_{IN} is measured across the MAX5982A/MAX5982B/MAX5982C input V_{DD} to V_{SS} .

MAX5982A/MAX5982B/ MAX5982C

IEEE 802.3af/at-Compliant, Powered Device Interface Controllers with Integrated 70W High-Power MOSFET

Alternatively, the $\overline{2EC}$ output also serves as a wall adapter detection output when the MAX5982A/MAX5982B/MAX5982C are powered by an external wall power adapter. See the *Wall Power Adapter Detection and Operation* section for more information.

Power Mode (Wake Mode)

The MAX5982A/MAX5982B/MAX5982C enter power mode when V_{IN} rises above the undervoltage-lockout threshold (V_{ON}). When V_{IN} rises above V_{ON} , the MAX5982A/MAX5982B/MAX5982C turn on the internal n-channel isolation MOSFET to connect V_{SS} to RTN with inrush current limit internally set to 53mA when $V_{RTN} - V_{SS} > 7V$ and 135mA when $V_{RTN} - V_{SS} < 7V$. The isolation MOSFET is fully turned on when the voltage at RTN is near V_{SS} and the inrush current is reduced below the inrush limit. Once the isolation MOSFET is fully turned on, the MAX5982A/MAX5982B/MAX5982C change the current limit to 1900mA (typ). The open-drain power-good output (PG) remains low for a minimum of t_{DELAY} until the power MOSFET fully turns on to keep the downstream DC-DC converter disabled during inrush.

Undervoltage Lockout

The MAX5982A/MAX5982B/MAX5982C operate up to a 60V supply voltage with a turn-on UVLO threshold (V_{ON}) at 35.4V and a turn-off UVLO threshold (V_{OFF}) at 31V. When the input voltage is above V_{ON} , the MAX5982A/MAX5982B/MAX5982C enter power mode and the internal MOSFET is turned on. When the input voltage goes below V_{OFF} for more than t_{OFF_DLY} , the MOSFET turns off.

Sleep and Ultra-Low-Power Sleep Modes (MAX5982A/MAX5982B)

The MAX5982A/MAX5982B feature a sleep mode, which pulls PG low while keeping the internal n-channel isolation MOSFET turned on. The PG output is used to disable downstream DC-DC converters reducing the power consumption of the overall PD system in sleep mode. In sleep mode, the LED driver output (LED) sources periodic current pulses. The LED current (I_{LED}) is set by an external resistor (R_{SL}); see the Applications Information section for more information. To enable sleep mode, apply a falling edge to \overline{SL} (MAX5982B) or hold \overline{SL} low for a minimum of 6 seconds after a falling edge.

An ultra-low-power sleep mode allows the MAX5982A/MAX5982B to further reduce power consumption while maintaining the power signature of the standard. The ultra-low-power sleep enable input \overline{ULP} is internally held high with a 50k Ω pullup resistor to the internal 5V bias of the MAX5982A/MAX5982B. To enable ultra-low-power sleep mode, set \overline{ULP} to logic-low and apply a falling

edge to \overline{SL} (MAX5982B) or hold \overline{SL} low for a minimum of 6s (MAX5982A). Apply a falling edge on the wake-mode enable input (\overline{WK}) to disable sleep or ultra-low-power sleep mode and resume normal operation.

LED Driver (MAX5982A/MAX5982B)

The MAX5982A/MAX5982B drive an LED connected from the output LED to V_{SS} . During sleep mode/ultra-low-power sleep mode, the LED is driven by current pulses with the amplitude set by the resistor connected from \overline{SL} to V_{SS} . The LED driver current amplitude is programmable from 10mA to 20mA using R_{SL} according to the following formula:

$$I_{LED} = \frac{645.75}{R_{SL} + 1200} \text{ (in amperes)}$$

Power-Good Output

An open-drain output (PG) is used to allow disabling downstream DC-DC converter until the n-channel isolation MOSFET is fully turned on. PG is pulled low to V_{SS} for a period of t_{DELAY} and until the internal isolation MOSFET is fully turned on. The PG is also pulled low during sleep mode and coming out of thermal shutdown.

Thermal-Shutdown Protection

The MAX5982A/MAX5982B/MAX5982C include thermal protection from excessive heating. If the junction temperature exceeds the thermal-shutdown threshold of +150°C, the MAX5982A/MAX5982B/MAX5982C turn off the internal power MOSFET, LED driver, and $\overline{2EC}$ current sink. When the junction temperature falls below +120°C, the devices enter inrush mode and then return to power mode. Inrush mode ensures the downstream DC-DC converter is turned off as the internal power MOSFET is turned on.

Wall Power Adapter Detection and Operation

For applications where an auxiliary power source such as a wall power adapter is used to power the PD, the MAX5982A/MAX5982B/MAX5982C feature wall power adapter detection. The MAX5982A/MAX5982B/MAX5982C give highest priority to the WAD and smoothly switch the power supply to WAD when it is detected. Once the input voltage ($V_{DD} - V_{SS}$) exceeds the mark event threshold, the MAX5982A/MAX5982B/MAX5982C enable wall adapter detection. The wall power adapter is connected from WAD to RTN. The MAX5982A/MAX5982B/MAX5982C detect the wall power adapter when the voltage from WAD to RTN is greater than 9V. When a wall power adapter is detected, the internal n-channel isolation MOSFET turns off, $\overline{2EC}$ current sink turns on, and classification current is disabled if V_{IN} is in the classification range.

MAX5982A/MAX5982B/ MAX5982C

IEEE 802.3af/at-Compliant, Powered Device Interface Controllers with Integrated 70W High-Power MOSFET

Applications Information

Operation with 12V Adapter

Layout Procedure

Careful PCB layout is critical to achieve high efficiency and low EMI. Follow these layout guidelines for optimum performance:

- 1) Place the input capacitor, classification resistor, and transient voltage suppressor as close as possible to the MAX5982A/MAX5982B/MAX5982C.

- 2) Use large SMT component pads for power dissipating devices such as the MAX5982A/MAX5982B/MAX5982C and the external diodes.
- 3) Use short and wide traces for high-power paths.
- 4) Place enough vias in the pad for the EP of the MAX5982A/MAX5982B/MAX5982C so that heat generated inside can be effectively dissipated by the PCB copper. The recommended spacing for the vias is 1mm to 1.2mm pitch. The thermal vias should be plated (1oz copper) and have a small barrel diameter (0.3mm to 0.33mm).

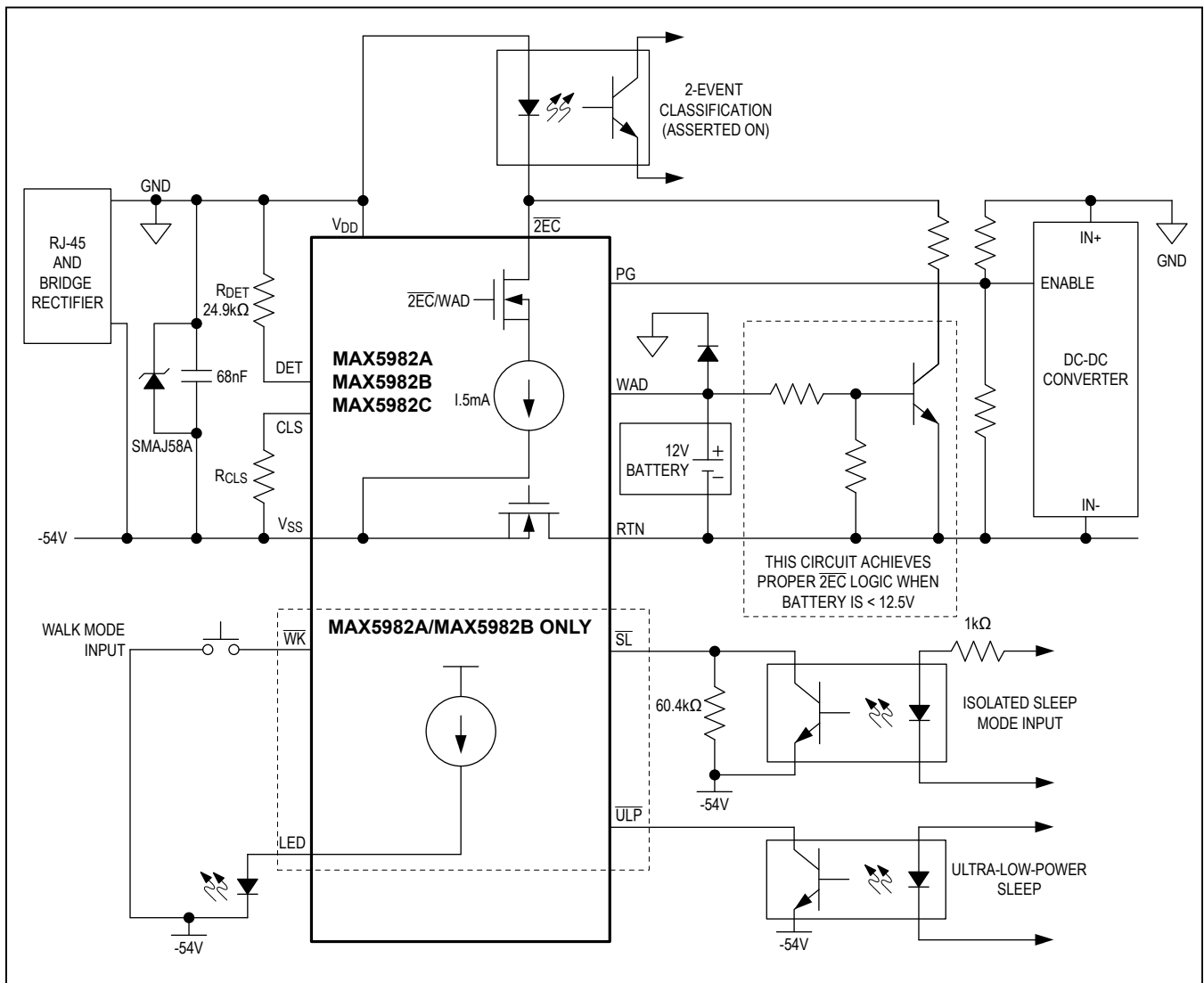

Figure 2. Typical Configuration When Using a 12V Wall Power Adapter

MAX5982A/MAX5982B/ MAX5982C

IEEE 802.3af/at-Compliant,
Powered Device Interface Controllers with
Integrated 70W High-Power MOSFET

Ordering Information

PART	TEMP RANGE	PIN-PACKAGE	SLEEP/ULTRA-LOW-POWER MODE	6s FILTER DELAY ON \overline{SL}
MAX5982AETE+	-40°C to +85°C	16 TQFN-EP*	Yes	Yes
MAX5982BETE+	-40°C to +85°C	16 TQFN-EP*	Yes	No
MAX5982CETE+	-40°C to +85°C	16 TQFN-EP*	No	—
MAX5982AATE+	-40°C to +125°C	16 TQFN-EP*	Yes	Yes

+Denotes a lead(Pb)-free/RoHS-compliant package.

*EP = Exposed pad.

Chip Information

PROCESS: BiCMOS

Package Information

For the latest package outline information and land patterns (footprints), go to www.maximintegrated.com/packages. Note that a "+", "#", or "-" in the package code indicates RoHS status only. Package drawings may show a different suffix character, but the drawing pertains to the package regardless of RoHS status.

PACKAGE TYPE	PACKAGE CODE	OUTLINE NO.	LAND PATTERN NO.
16 TQFN-EP	T1655+4	21-0140	90-0121