

Click [here](#) for production status of specific part numbers.

## MAX6033

## High-Precision, Low-Dropout SOT23 Series Voltage Reference

### General Description

The MAX6033 ultra-high-precision series voltage reference features a low 7ppm/°C (max) temperature coefficient and a low dropout voltage (200mV, max). Low temperature drift and low noise make the MAX6033 ideal for use with high-resolution ADCs or DACs.

- This device uses bandgap technology for low-noise performance and excellent accuracy. Laser-trimmed, high-stability, thin-film resistors, and post-package trimming guarantee excellent initial accuracy ( $\pm 0.04\%$ , max). The MAX6033 consumes only 40 $\mu$ A of supply current and sources up to 15mA. Series mode references save system power and use minimal external components compared to two-terminal shunt references.
- The MAX6033 is available in the miniature 6-pin SOT23 package and is offered over the automotive temperature range (-40°C to +125°C).

### Applications

- Precision Regulators
- A/D and D/A Converters
- Power Supplies
- Hard-Disk Drives
- High-Accuracy Industrial and Process Control
- Hand-Held Instruments

*Typical Operating Circuit* appears at end of data sheet.

### Benefits and Features

- Stable Performance Over Temperature and Time Improves Accuracy
  - Ultra-Low Temperature Drift: 7ppm/°C (max)
  - $\pm 0.04\%$  Initial Accuracy
  - Stable with Capacitive Loads up to 100 $\mu$ F
  - Low 16 $\mu$ V<sub>p-p</sub> Noise (0.1Hz to 10Hz) (2.5V Output)
  - Low 200mV Dropout Voltage
  - Excellent Load Regulation: 0.001mV/mA
- Low 40 $\mu$ A Quiescent Current Reduces System Power Consumption
- 2.7V to 12.6V Supply Voltage Eases Power Requirements

### Pin Configuration

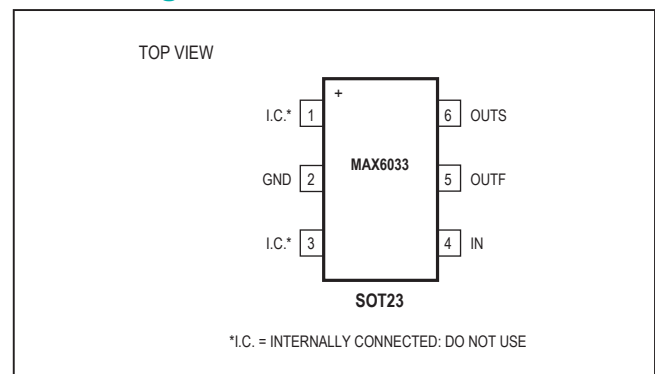

### Ordering Information/Selector Guide

PART	OUTPUT VOLTAGE (V)	TEMP COEFF (PPM/°C)	INITIAL ACCURACY (%)	TOP MARK
MAX6033AAUT25-T	2.500	10	0.04	ABDF
MAX6033BAUT25+T	2.500	15	0.20	+AAXL
MAX6033BAUT25-T	2.500	15	0.20	AAXL
MAX6033CAUT25-T	2.500	40	0.10	AAXH
MAX6033CAUT25+T	2.500	40	0.10	+AAXH

*Ordering Information/Selector Guide* continued on last page.

#Denotes a RoHS-compliant device that may include lead(Pb) that is exempt under the RoHS requirements.

T = Tape and reel.

\*Denote as a future part.

**Absolute Maximum Ratings**

IN to GND.....	-0.3V to +13V	Maximum Junction Temperature .....	+150°C
OUTF, OUTS to GND.....	-0.3V to +6V	Lead Temperature (soldering, 10s) .....	+300°C
Continuous Power Dissipation (TA = +70°C)		Soldering Temperature (reflow)	
6-Pin SOT23 (derate 7.40mW/°C above +70°C) ...	595.20mW	RoHS-Compliant Packages .....	+245°C
Operating Temperature Range.....	-40°C to +125°C	Packages Containing Lead(Pb).....	+240°C
Storage Temperature Range .....	-65°C to +150°C		

*Stresses beyond those listed under "Absolute Maximum Ratings" may cause permanent damage to the device. These are stress ratings only, and functional operation of the device at these or any other conditions beyond those indicated in the operational sections of the specifications is not implied. Exposure to absolute maximum rating conditions for extended periods may affect device reliability.*

**Package Information**

**6 SOT23**

PACKAGE CODE	U6F+6
Outline Number	<a href="#">21-0058</a>
Land Pattern Number	<a href="#">90-0175</a>
<b>Thermal Resistance, Single-Layer Board</b>	
Junction to Ambient (θ <sub>JA</sub> )	185.50
Junction to Case (θ <sub>JC</sub> )	75
<b>Thermal Resistance, Four-Layer Board</b>	
Junction to Ambient (θ <sub>JA</sub> )	134.40
Junction to Case (θ <sub>JC</sub> )	39

**RoHS SOT23-6**

PACKAGE CODE	U6FH+6
Outline Number	—
Land Pattern Number	—
<b>Thermal Resistance, Single-Layer Board</b>	
Junction to Ambient (θ <sub>JA</sub> )	185.50
Junction to Case (θ <sub>JC</sub> )	75
<b>Thermal Resistance, Four-Layer Board</b>	
Junction to Ambient (θ <sub>JA</sub> )	134.40
Junction to Case (θ <sub>JC</sub> )	39

For the latest package outline information and land patterns (footprints), go to [www.maximintegrated.com/packages](http://www.maximintegrated.com/packages). Note that a "+", "#", or "-" in the package code indicates RoHS status only. Package drawings may show a different suffix character, but the drawing pertains to the package regardless of RoHS status.

Package thermal resistances were obtained using the method described in JEDEC specification JESD51-7, using a four-layer board. For detailed information on package thermal considerations, refer to [www.maximintegrated.com/thermal-tutorial](http://www.maximintegrated.com/thermal-tutorial).

**Electrical Characteristics— $V_{OUT} = 2.500V$**

( $V_{IN} = 5V$ ,  $C_{OUT} = 0.1\mu F$ ,  $I_{OUT} = 0A$ ,  $T_A = T_{MIN}$  to  $T_{MAX}$ , unless otherwise specified. Typical values are at  $T_A = +25^\circ C$ .) (Note 1)

PARAMETER	SYMBOL	CONDITIONS		MIN	TYP	MAX	UNITS
Output Voltage	$V_{OUT}$	$T_A = +25^\circ C$	MAX6033A	2.4990	2.5000	2.5010	V
			MAX6033B	2.4950	2.5000	2.5050	
			MAX6033C	2.4975	2.5000	2.5025	
Output-Voltage Accuracy		$T_A = +25^\circ C$	MAX6033A	-0.04		+0.04	%
			MAX6033B	-0.2		+0.2	
			MAX6033C	-0.1		+0.1	
Output Voltage Temperature Coefficient	$TCV_{OUT}$	MAX6033A	$T_A = -40^\circ C$ to $+85^\circ C$		1.5	7	ppm/ $^\circ C$
			$T_A = -40^\circ C$ to $+125^\circ C$		2.5	10	
		MAX6033B	$T_A = -40^\circ C$ to $+85^\circ C$		3	10	
			$T_A = -40^\circ C$ to $+125^\circ C$		7	15	
		MAX6033C	$T_A = -40^\circ C$ to $+85^\circ C$		6	20	
			$T_A = -40^\circ C$ to $+125^\circ C$		10	40	
Input Voltage Range	$V_{IN}$	Inferred from line regulation specification		2.7		12.6	V
Line Regulation	$\frac{\Delta V_{OUT}}{\Delta V_{IN}}$	$2.7V \leq V_{IN} \leq 12.6V$	$T_A = +25^\circ C$		3	25	$\mu V/V$
			$T_A = -40^\circ C$ to $+125^\circ C$			50	
Load Regulation	$\frac{\Delta V_{OUT}}{\Delta I_{OUT}}$	$-100\mu A \leq I_{OUT} \leq 15mA$	$T_A = +25^\circ C$		0.001	0.05	mV/mA
			$T_A = -40^\circ C$ to $+125^\circ C$			0.1	
Dropout Voltage (Note 2)	$V_{DO}$	$V_{OUT} = 0.1\%$ , $I_{OUT} = 10mA$	$V_{OUT} = 0.1\%$ , $I_{OUT} = 1mA$		0.02	0.2	V
			$T_A = -40^\circ C$ to $+85^\circ C$		0.3	0.4	
				$T_A = -40^\circ C$ to $+125^\circ C$			
Quiescent Supply Current	$I_{IN}$	$T_A = +25^\circ C$	$T_A = -40^\circ C$ to $+85^\circ C$		40	60	$\mu A$
			$T_A = -40^\circ C$ to $+125^\circ C$			75	
			$T_A = -40^\circ C$ to $+125^\circ C$			85	
Output Short-Circuit Current	$I_{SC}$		$V_{OUT} = 0V$		90		mA
			$V_{OUT} = V_{IN}$		-2		
Output-Voltage Noise	en		$0.1Hz \leq f \leq 10Hz$		16		$\mu V_{P-P}$
			$10Hz \leq f \leq 1kHz$		12		$\mu V_{RMS}$
Turn-On Settling Time	$t_{ON}$		$V_{OUT}$ settles to $\pm 0.01\%$ of final value		500		$\mu s$
Temperature Hysteresis			(Note 3)		150		ppm
Long-Term Stability			$\Delta t = 1000hr$		40		ppm

**Electrical Characteristics— $V_{OUT} = 3.000V$** (V<sub>IN</sub> = 5V, C<sub>OUT</sub> = 0.1μF, I<sub>OUT</sub> = 0A, T<sub>A</sub> = T<sub>MIN</sub> to T<sub>MAX</sub>, unless otherwise specified. Typical values are at T<sub>A</sub> = +25°C.) (Note 1)

PARAMETER	SYMBOL	CONDITIONS		MIN	TYP	MAX	UNITS
Output Voltage	V <sub>OUT</sub>	T <sub>A</sub> = +25°C	MAX6033A	2.9988	3.0000	3.0012	V
			MAX6033B	2.9940	3.0000	3.0060	
			MAX6033C	2.9970	3.0000	3.0030	
Output-Voltage Accuracy		T <sub>A</sub> = +25°C	MAX6033A	-0.04		+0.04	%
			MAX6033B	-0.2		+0.2	
			MAX6033C	-0.1		+0.1	
Output-Voltage Temperature Coefficient	TCV <sub>OUT</sub>	MAX6033A	T <sub>A</sub> = -40°C to +85°C		1.5	7	ppm/°C
			T <sub>A</sub> = -40°C to +125°C		2.5	10	
		MAX6033B	T <sub>A</sub> = -40°C to +85°C		3	10	
			T <sub>A</sub> = -40°C to +125°C		7	15	
		MAX6033C	T <sub>A</sub> = -40°C to +85°C		6	20	
T <sub>A</sub> = -40°C to +125°C		10	40				
Input Voltage Range	V <sub>IN</sub>	Inferred from line regulation specification		3.2		12.6	V
Line Regulation	$\frac{\Delta V_{OUT}}{\Delta V_{IN}}$	3.2V ≤ V <sub>IN</sub> ≤ 12.6V	T <sub>A</sub> = +25°C		4	30	μV/V
			T <sub>A</sub> = -40°C to +125°C			60	
Load Regulation	$\frac{\Delta V_{OUT}}{\Delta I_{OUT}}$	-100μA ≤ I <sub>OUT</sub> ≤ 15mA	T <sub>A</sub> = +25°C		0.002	0.06	mV/mA
			T <sub>A</sub> = -40°C to +125°C			0.12	
Dropout Voltage (Note 2)	V <sub>DO</sub>	ΔV <sub>OUT</sub> = 0.1%	I <sub>OUT</sub> = 1mA		0.02	0.2	V
			I <sub>OUT</sub> = 10mA		0.2	0.4	
Quiescent Supply Current	I <sub>IN</sub>	T <sub>A</sub> = +25°C			40	60	μA
		T <sub>A</sub> = -40°C to +85°C				75	
		T <sub>A</sub> = -40°C to +125°C					
Output Short-Circuit Current	I <sub>SC</sub>	V <sub>OUT</sub> = 0V			90		mA
		V <sub>OUT</sub> = V <sub>IN</sub>			-2		
Output-Voltage Noise	en	0.1Hz ≤ f ≤ 10Hz			24		μV <sub>P-P</sub>
		10Hz ≤ f ≤ 1kHz			15		μV <sub>RMS</sub>
Turn-On Settling Time	t <sub>ON</sub>	V <sub>OUT</sub> settles to ±0.01% of final value			600		μs
Temperature Hysteresis		(Note 3)			150		ppm
Long-Term Stability		Δt = 1000hr			40		ppm

**Electrical Characteristics— $V_{OUT} = 4.096V$**  $(V_{IN} = 5V, C_{OUT} = 0.1\mu F, I_{OUT} = 0A, T_A = T_{MIN}$  to  $T_{MAX}$ , unless otherwise specified. Typical values are at  $T_A = +25^\circ C$ .) (Note 1)

PARAMETER	SYMBOL	CONDITIONS		MIN	TYP	MAX	UNITS
Output Voltage	$V_{OUT}$	$T_A = +25^\circ C$	MAX6033A	4.0943	4.0960	4.0977	V
			MAX6033B	4.0878	4.0960	4.1042	
			MAX6033C	4.0919	4.0960	4.1001	
Output-Voltage Accuracy		$T_A = +25^\circ C$	MAX6033A	-0.04		+0.04	%
			MAX6033B	-0.2		+0.2	
			MAX6033C	-0.1		+0.1	
Output-Voltage Temperature Coefficient	$TCV_{OUT}$	MAX6033A	$T_A = -40^\circ C$ to $+85^\circ C$		1.5	7	ppm/ $^\circ C$
			$T_A = -40^\circ C$ to $+125^\circ C$		2.5	10	
		MAX6033B	$T_A = -40^\circ C$ to $+85^\circ C$		3	10	
			$T_A = -40^\circ C$ to $+125^\circ C$		7	15	
		MAX6033C	$T_A = -40^\circ C$ to $+85^\circ C$		6	20	
			$T_A = -40^\circ C$ to $+125^\circ C$		10	40	
Input-Voltage Range	$V_{IN}$	Inferred from line regulation specification		4.3		12.6	V
Line Regulation	$\frac{\Delta V_{OUT}}{\Delta V_{IN}}$	$4.3V \leq V_{IN} \leq 12.6V$	$T_A = +25^\circ C$		6	30	$\mu V/V$
			$T_A = -40^\circ C$ to $+125^\circ C$			60	
Load Regulation	$\frac{\Delta V_{OUT}}{\Delta I_{OUT}}$	$-100\mu A \leq I_{OUT} \leq 15mA$	$T_A = +25^\circ C$		0.002	0.08	mV/mA
			$T_A = -40^\circ C$ to $+125^\circ C$			0.15	
Dropout Voltage (Note 2)	$V_{DO}$	$\Delta V_{OUT} = 0.1\%$	$I_{OUT} = 1mA$		0.02	0.2	V
			$I_{OUT} = 10mA$		0.2	0.4	
Quiescent Supply Current	$I_{IN}$	$T_A = +25^\circ C$			40	60	$\mu A$
		$T_A = -40^\circ C$ to $+85^\circ C$				75	
		$T_A = -40^\circ C$ to $+125^\circ C$					
Output Short-Circuit Current	$I_{SC}$	$V_{OUT} = 0V$			90		mA
		$V_{OUT} = V_{IN}$			-2		
Output-Voltage Noise	$e_n$	$0.1Hz \leq f \leq 10Hz$			32		$\mu V_{P-P}$
		$10Hz \leq f \leq 1kHz$			22		$\mu V_{RMS}$
Turn-On Settling Time	$t_{ON}$	$V_{OUT}$ settles to $\pm 0.01\%$ of final value			800		$\mu s$
Temperature Hysteresis		(Note 3)			150		ppm
Long-Term Stability		$\Delta t = 1000hr$			40		ppm

Electrical Characteristics— $V_{OUT} = 5.000V$ (V<sub>IN</sub> = 5.5V, C<sub>OUT</sub> = 0.1μF, I<sub>OUT</sub> = 0A, T<sub>A</sub> = T<sub>MIN</sub> to T<sub>MAX</sub>, unless otherwise specified. Typical values are at T<sub>A</sub> = +25°C.) (Note 1)

PARAMETER	SYMBOL	CONDITIONS		MIN	TYP	MAX	UNITS
Output Voltage	V <sub>OUT</sub>	T <sub>A</sub> = +25°C	MAX6033A	4.9980	5.000	5.0020	V
			MAX6033B	4.9900	5.000	5.0100	
			MAX6033C	4.9950	5.000	5.0050	
Output-Voltage Accuracy		T <sub>A</sub> = +25°C	MAX6033A	-0.04		+0.04	%
			MAX6033B	-0.2		+0.2	
			MAX6033C	-0.1		+0.1	
Output-Voltage Temperature Coefficient	TCV <sub>OUT</sub>	MAX6033A	T <sub>A</sub> = -40°C to +85°C		1.5	7	ppm/°C
			T <sub>A</sub> = -40°C to +125°C		2.5	10	
		MAX6033B	T <sub>A</sub> = -40°C to +85°C		3	10	
			T <sub>A</sub> = -40°C to +125°C		7	15	
		MAX6033C	T <sub>A</sub> = -40°C to +85°C		6	20	
			T <sub>A</sub> = -40°C to +125°C		10	40	
Input Voltage Range	V <sub>IN</sub>	Inferred from line regulation specification		5.2		12.6	V
Line Regulation	$\frac{\Delta V_{OUT}}{\Delta V_{IN}}$	5.2V ≤ V <sub>IN</sub> ≤ 12.6V	T <sub>A</sub> = +25°C		7	50	μV/V
			T <sub>A</sub> = -40°C to +125°C			100	
Load Regulation	$\frac{\Delta V_{OUT}}{\Delta I_{OUT}}$	-100μA ≤ I <sub>OUT</sub> ≤ 15mA	T <sub>A</sub> = +25°C		0.003	0.1	mV/mA
			T <sub>A</sub> = -40°C to +125°C			0.2	
Dropout Voltage (Note 2)	V <sub>DO</sub>	ΔV <sub>OUT</sub> = 0.1%	I <sub>OUT</sub> = 1mA		0.02	0.2	V
			I <sub>OUT</sub> = 10mA		0.2	0.4	
Quiescent Supply Current	I <sub>IN</sub>	T <sub>A</sub> = +25°C			40	60	μA
		T <sub>A</sub> = -40°C to +85°C				75	
		T <sub>A</sub> = -40°C to +125°C					
Output Short-Circuit Current	I <sub>SC</sub>	V <sub>OUT</sub> = 0V			90		mA
		V <sub>OUT</sub> = V <sub>IN</sub>			-2		
Output-Voltage Noise	en	0.1Hz ≤ f ≤ 10Hz			40		μV <sub>P-P</sub>
		10Hz ≤ f ≤ 1kHz			26		μV <sub>RMS</sub>
Turn-On Settling Time	t <sub>ON</sub>	V <sub>OUT</sub> settles to ±0.01% of final value			1000		μs
Temperature Hysteresis		(Note 3)			150		ppm
Long-Term Stability		Δt = 1000hr			40		ppm

Note 1: MAX6033 is 100% production tested at T<sub>A</sub> = +25°C and is guaranteed by design for T<sub>A</sub> = T<sub>MIN</sub> to T<sub>MAX</sub> as specified.Note 2: Dropout Voltage is the minimum input voltage at which V<sub>OUT</sub> changes ≤ 0.1% from V<sub>OUT</sub> at V<sub>IN</sub> = 5V (V<sub>IN</sub> = 5.5V to V<sub>OUT</sub> = 5V).Note 3: Temperature Hysteresis is defined as the change in +25°C output voltage before and after cycling the device from T<sub>MAX</sub> to T<sub>MIN</sub>.

Typical Operating Characteristics

( $V_{IN} = 5V$ ,  $C_{OUT} = 0.1\mu F$ ,  $I_{OUT} = 0A$ ,  $T_A = +25^\circ C$ , unless otherwise specified.) (Note 4)

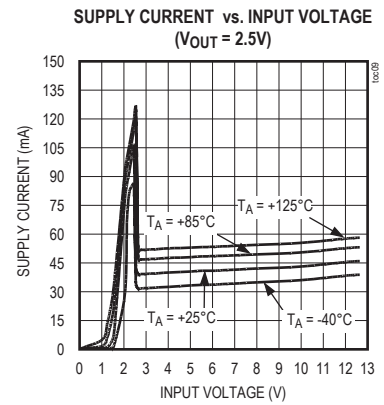
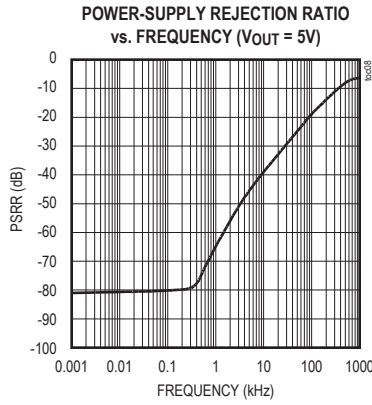
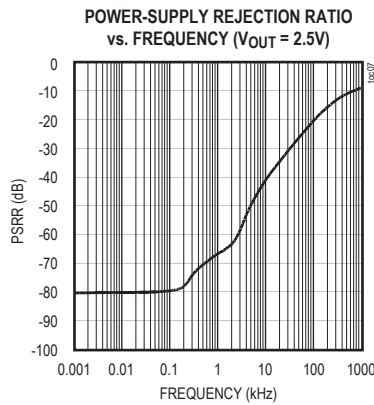
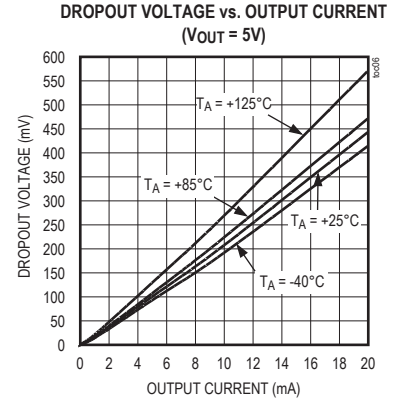
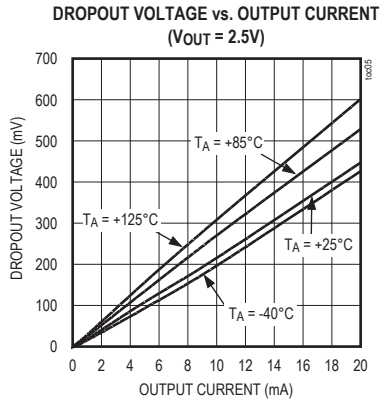
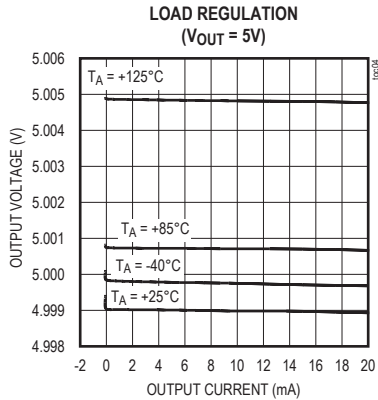
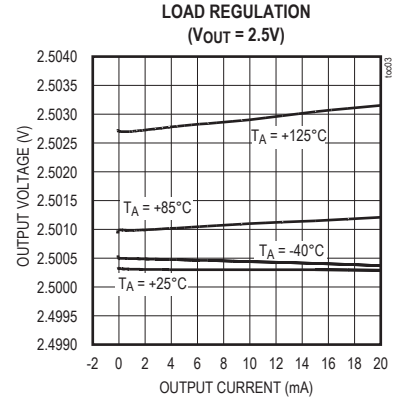
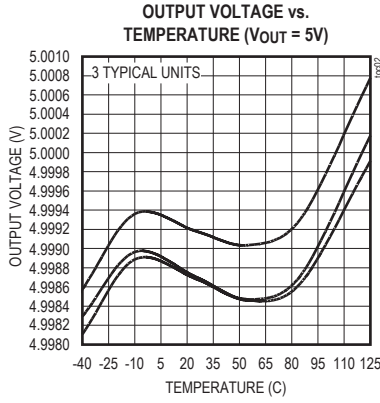
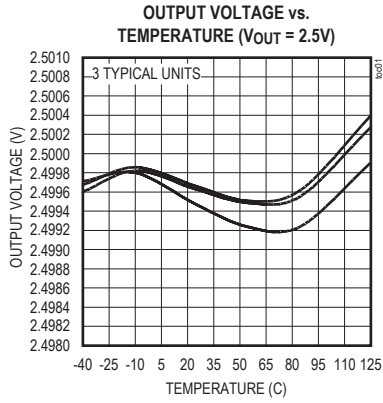

Typical Operating Characteristics (continued)

( $V_{IN} = 5V$ ,  $C_{OUT} = 0.1\mu F$ ,  $I_{OUT} = 0A$ ,  $T_A = +25^\circ C$ , unless otherwise specified.) (Note 4)

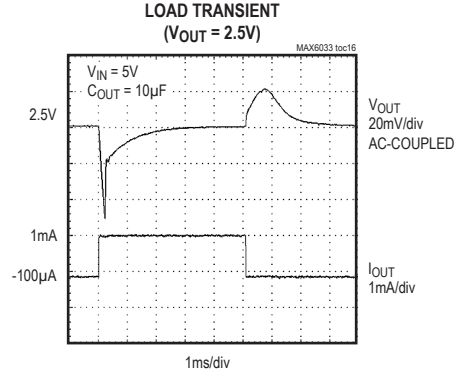
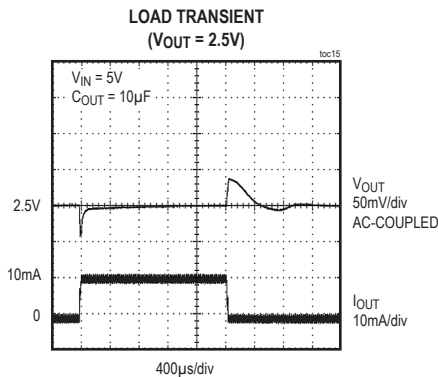
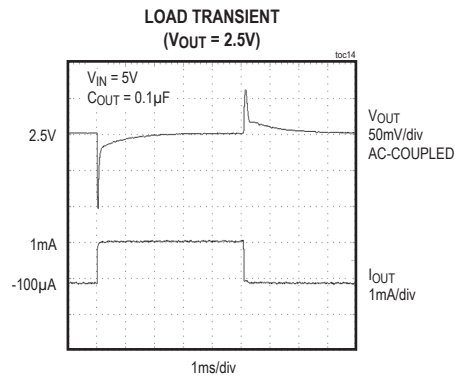
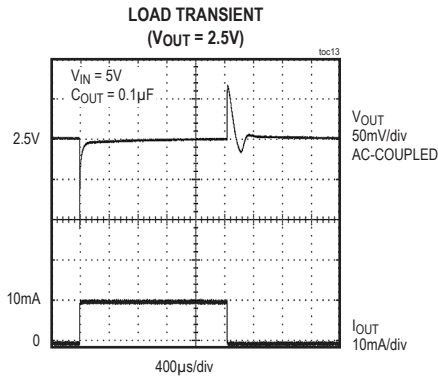
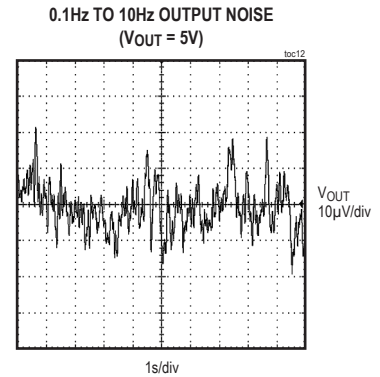
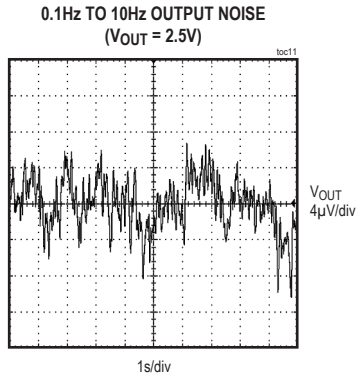
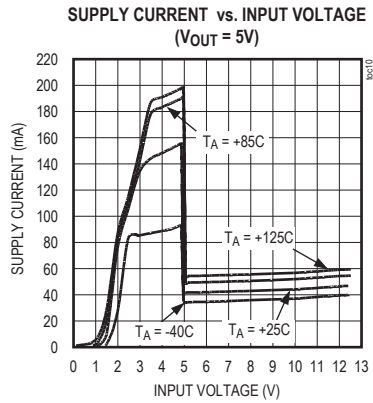



Typical Operating Characteristics (continued)

( $V_{IN} = 5V$ ,  $C_{OUT} = 0.1\mu F$ ,  $I_{OUT} = 0A$ ,  $T_A = +25^\circ C$ , unless otherwise specified.) (Note 4)

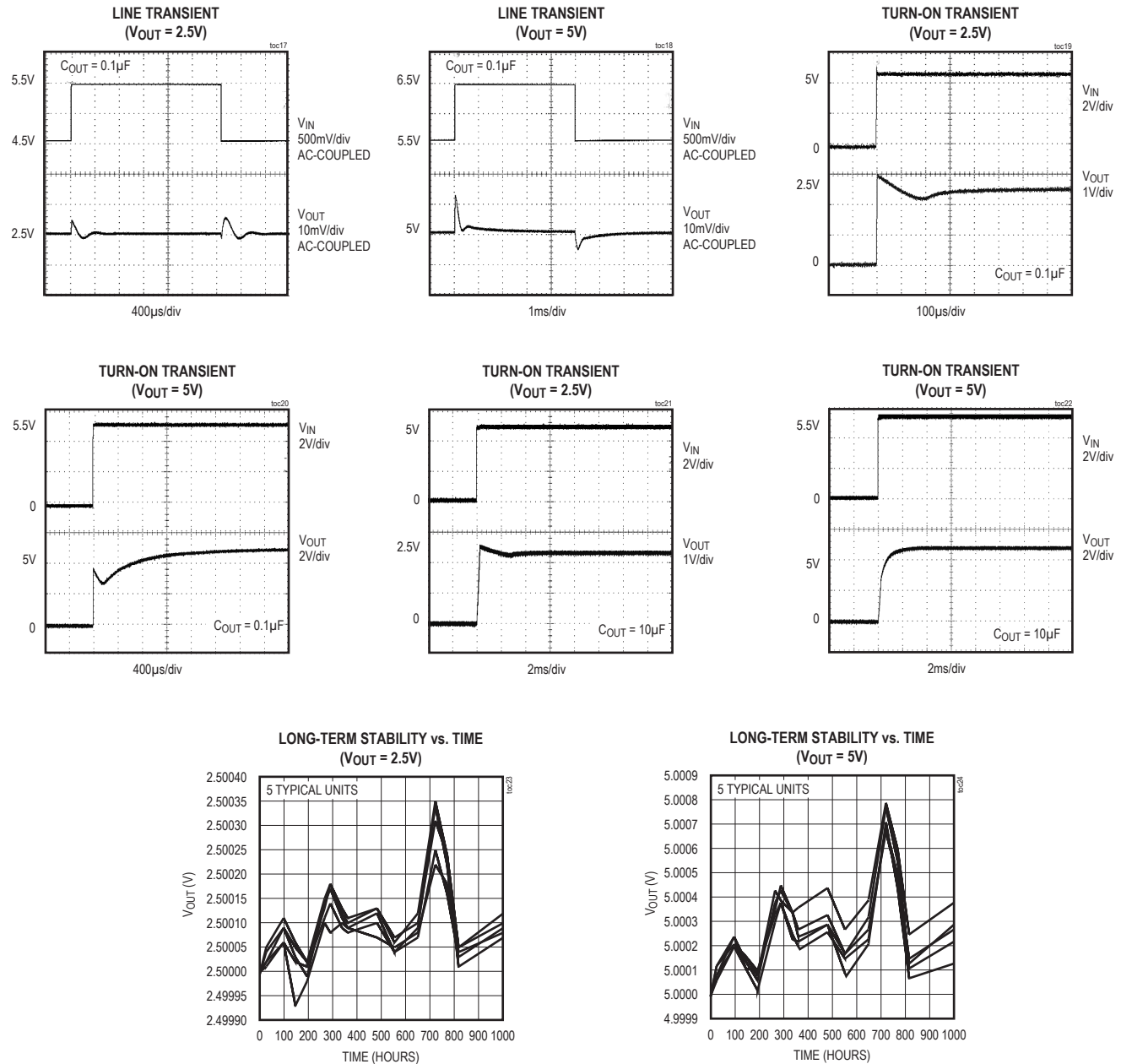

**Note 4:** Many of the MAX6033 Typical Operating Characteristics are similar. The extremes of these characteristics are found in the MAX6033 (2.5V output) and the MAX6033 (5V output). The Typical Operating Characteristics of the remainder of the MAX6033 family typically lie between these two extremes and can be estimated based on their output voltages.

**Pin Description**

PIN	NAME	FUNCTION
1, 3	I.C.	Internally Connected. Do not connect externally.
2	GND	Ground
4	IN	Positive Power-Supply Input
5	OUTF	Voltage Reference Force Output. Short OUTF to OUTS as close to the device as possible. Bypass OUTF with 0.1µF (min) capacitor to GND.
6	OUTS	Voltage Reference Sense

**Applications Information**

**Bypassing/Load Capacitance**

For the best line-transient performance, decouple the input with a 0.1µF ceramic capacitor as shown in the Typical Operating Circuit. Place the capacitor as close to IN as possible. When transient performance is less important, no capacitor is necessary.

The MAX6033 family requires a minimum output capacitance of 0.1µF for stability and is stable with capacitive loads (including the bypass capacitance) of up to 100µF. In applications where the load or the supply can experience step changes, a larger output capacitor reduces the amount of overshoot (undershoot) and improves the circuit's transient response. Place output capacitors as close to the device as possible.

**Supply Current**

The quiescent supply current of the MAX6033 series reference is typically 40µA and is virtually independent of the supply voltage. In the MAX6033 family, the load current is drawn from the input only when required, so supply current is not wasted and efficiency is maximized at all input voltages. This improved efficiency reduces power dissipation and extends battery life.

When the supply voltage is below the minimum-specified input voltage (as during turn-on), the devices can draw up to 150µA beyond the nominal supply current. The input voltage source must be capable of providing this current to ensure reliable turn-on.

**Output-Voltage Hysteresis**

Output voltage hysteresis is the change in the output voltage at  $T_A = +25^\circ\text{C}$  before and after the device is cycled over its entire operating temperature range. Hysteresis is caused by differential package stress appearing across

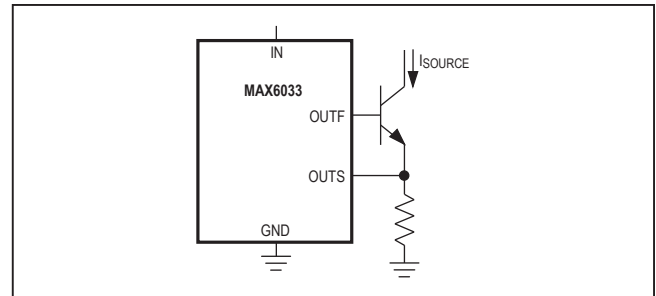

Figure 1. Precision Current Source

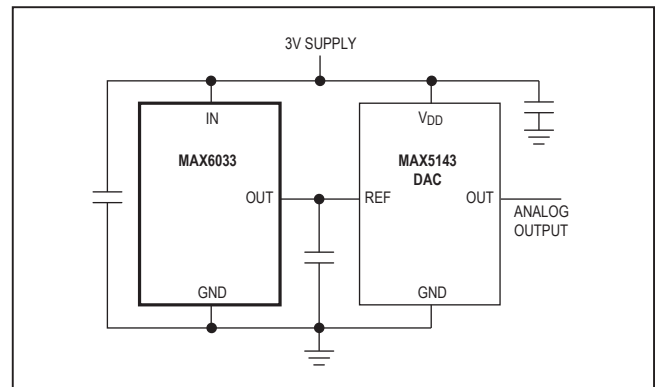

Figure 2. 14-Bit High-Resolution DAC and Positive Reference from a Single 3V Supply

the bandgap core transistors. The typical temperature hysteresis value is 150ppm.

**Turn-On Time**

These devices typically turn on and settle to within 0.01% of their final value in  $>1\mu\text{s}$ . The turn-on time can increase up to 2ms with the device operating at the minimum drop-out voltage and the maximum load.

**Precision Current Source**

Figure 1 shows a typical circuit providing a precision current source. The OUTF output provides the bias current for the bipolar transistor. OUTS senses the voltage across the resistor and adjusts the current sourced by OUTF accordingly.

**High-Resolution DAC and Reference from Single Supply**

Figure 2 shows a typical circuit providing both the power supply and reference for a high-resolution DAC. A MAX6033 with 2.5V output provides the reference voltage for the DAC.

## Ordering Information/Selector Guide (continued)

PART	OUTPUT VOLTAGE (V)	TEMP COEFF (PPM/°C)	INITIAL ACCURACY (%)	TOP MARK
MAX6033AAUT30-T	3.000	10	0.04	ABDG
MAX6033BAUT30+T	3.000	15	0.20	+AAXM
MAX6033BAUT30-T	3.000	15	0.20	AAXM
MAX6033BAUT30+T	3.000	15	0.20	+AAXM
MAX6033CAUT30-T	3.000	40	0.10	AAXI
MAX6033CAUT30+T	3.000	40	0.10	+AAXI
MAX6033AAUT41-T	4.096	10	0.04	ABDH
MAX6033BAUT41+T	4.096	15	0.20	+AAXN
MAX6033BAUT41-T	4.096	15	0.20	AAXN
MAX6033CAUT41-T	4.096	40	0.10	AAXJ
MAX6033CAUT41+T	4.096	40	0.10	+AAXJ
MAX6033AAUT50-T	5.000	10	0.04	ABDI
MAX6033BAUT50+T	5.000	15	0.20	+AAXO
MAX6033BAUT50-T	5.000	15	0.20	AAXO
MAX6033CAUT50-T	5.000	40	0.10	AAXK
MAX6033CAUT50+T	5.000	40	0.10	+AAXK

#Denotes a RoHS-compliant device that may include lead(Pb) that is exempt under the RoHS requirements.

T = Tape and reel.

Typical Operating Circuit

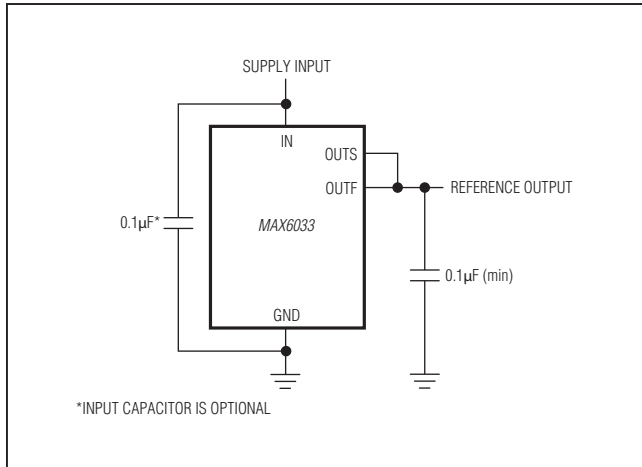

Chip Information

PROCESS: BiCMOS