

# MAX6072

# High-Precision, Dual-Output Series Voltage Reference

## General Description

The MAX6072 is a dual-output precision series voltage reference. The product features two outputs,  $+V_{REF}$  and  $+V_{REF}/2$ . The device exhibits a very low  $1/f$  noise of 2ppm (peak-to-peak). Each output can source and sink 10mA and has an independent sense line. This product has a temperature drift of 6ppm/ $^{\circ}$ C (max) over the ambient temperature range of  $-40^{\circ}$ C to  $+125^{\circ}$ C and an initial accuracy of 0.04%. Three pairs of output voltages are available: 5V/2.5V, 4.096V/2.048V, and 2.5V/1.25V. The product operates with an input voltage range of 2.8V to 5.5V and has sufficient headroom for the highest voltage. It consumes a mere 150 $\mu$ A (typ) of quiescent supply current per reference. The dual voltage outputs make this device ideal for precision ADC applications where the input signal needs to be referred to  $V_{REF}/2$ .

The MAX6072 is available in a 10-pin  $\mu$ MAX<sup>®</sup> package and is specified for operation over the extended  $-40^{\circ}$ C to  $+125^{\circ}$ C industrial temperature range.

## Applications

- ADC/DAC References and Common-Mode Set-Point
- Test and Measurement/ATE
- High-Accuracy Industrial and Process Control
- Portable Medical

## Benefits and Features

- Low Temperature Coefficient Ensures Stable System Over Wide Temperature Ranges
  - A-grade: 6ppm/ $^{\circ}$ C (max)
  - B-grade: 8ppm/ $^{\circ}$ C (max)
- Excellent Long-Term Drift Ensures Accurate Signal Chain Readings Over Time
  - 15ppm Drift Over 1,000 Hours
- Dual References ( $V_{REF}$  and  $V_{REF}/2$ ) Provide ADC/DAC Reference and Common-Mode Reference
  - MAX6072\_\_50:  $V_{REF} = 5V$ ,  $V_{REF}/2 = 2.5V$
  - MAX6072\_\_41:  $V_{REF} = 4.096V$ ,  $V_{REF}/2 = 2.048V$
  - MAX6072\_\_25:  $V_{REF} = 2.5V$ ,  $V_{REF}/2 = 1.25V$
- Low Thermal Hysteresis Ensures Consistent Results Through Temperature Cycles
  - 85ppm
  - 2.5ppm Thermal Hysteresis Tracking
- Separate Enable-Control for Each Output Allows Independent Control
- Low Power for Battery-/Loop-Powered Sensors: 150 $\mu$ A/Reference

*Typical Operating Circuit and Ordering Information appears at end of data sheet.*

*For related parts and recommended products to use with this part, refer to [www.maximintegrated.com/MAX6072.related](http://www.maximintegrated.com/MAX6072.related).*

## Dual Reference Selector Guide

PART	OUTPUT VOLTAGES (V)	ACCURACY (%)	TEMPERATURE COEFFICIENT (ppm/ $^{\circ}$ C)
MAX6072AAUB50	5/2.5	0.05	6
MAX6072BAUB50	5/2.5	0.08	8
MAX6072AAUB41	4.096/2.048	0.05	6
MAX6072BAUB41	4.096/2.048	0.08	8
MAX6072AAUB25	2.5/1.25	0.05	6
MAX6072BAUB25	2.5/1.25	0.08	8

*$\mu$ MAX is a registered trademark of Maxim Integrated Products, Inc.*



**Absolute Maximum Ratings**

IN1, IN2 to GND .....	-0.3V to +6V	Operating Temperature Range .....	-40°C to +125°C
OUT1F to GND .....	-0.3V to the lower of (V <sub>IN1</sub> + 0.3V), +6V	Storage Temperature .....	-65°C to +150°C
OUT2F to GND .....	-0.3V to the lower of (V <sub>IN2</sub> + 0.3V), +6V	Junction Temperature .....	+150°C
OUT1S, OUT2S to GND .....	-0.3V to +6V	Lead Temperature (soldering, 10s) .....	+300°C
EN1, EN2 to GND .....	-0.3V to +6V	Soldering Temperature .....	+260°C
Continuous Power Dissipation (T <sub>A</sub> = +70°C)			
μMAX (derate 5.6mW/°C above +70°C) .....	444mW		

Stresses beyond those listed under "Absolute Maximum Ratings" may cause permanent damage to the device. These are stress ratings only, and functional operation of the device at these or any other conditions beyond those indicated in the operational sections of the specifications is not implied. Exposure to absolute maximum rating conditions for extended periods may affect device reliability.

**Package Thermal Characteristics (Note 1)**

μMAX			
Junction-to-Ambient Thermal Resistance (θ <sub>JA</sub> ) .....	180°C/W	Junction-to-Case Thermal Resistance (θ <sub>JC</sub> ) .....	42°C/W

**Note 1:** Package thermal resistances were obtained using the method described in JEDEC specification JESD51-7, using a four-layer board. For detailed information on package thermal considerations, refer to [www.maximintegrated.com/thermal-tutorial](http://www.maximintegrated.com/thermal-tutorial).

**MAX6072\_50 Electrical Characteristics (V<sub>REF1</sub>: V<sub>OUT1F</sub> = 5V, V<sub>REF2</sub>: V<sub>OUT2F</sub> = 2.5V)**

(V<sub>IN1</sub> = V<sub>EN1</sub> = V<sub>IN2</sub> = V<sub>EN2</sub> = +5.5V, I<sub>OUT</sub> = 0mA, C<sub>OUT</sub> = 0.1μF, T<sub>A</sub> = -40°C to +125°C, unless otherwise noted. Typical values are at T<sub>A</sub> = +25°C.) (Note 2)

PARAMETER	SYMBOL	CONDITIONS	MIN	TYP	MAX	UNITS
<b>OUTPUT</b>						
Output Voltage Accuracy (OUT1F and OUT2F)		MAX6072A_50, T <sub>A</sub> = +25°C	-0.05		+0.05	%
		MAX6072B_50, T <sub>A</sub> = +25°C	-0.08		+0.08	
Output Voltage Temperature Drift (OUT1F and OUT2F) (Note 3)	TCV <sub>OUT</sub>	MAX6072A_50		1.5	6	ppm/°C
		MAX6072B_50		2.0	8	
Output Voltage Temperature Drift Tracking (OUT1F and OUT2F) (Note 3)	ΔTC	MAX6072A_50		0.4		ppm/°C
		MAX6072B_50		0.4		
Line Regulation		OUT1F, 5.2V < V <sub>IN1</sub> < 5.5V	T <sub>A</sub> = +25°C	200	620	μV/V
			T <sub>A</sub> = -40°C to +125°C		700	
		OUT2F, 2.8V < V <sub>IN2</sub> < 5.5V	T <sub>A</sub> = +25°C	60	260	
			T <sub>A</sub> = -40°C to +125°C		275	
Load Regulation		0mA < I <sub>OUT</sub> < 10mA, sink	OUT1F	160	290	μV/mA
				0mA < I <sub>OUT</sub> < 10mA, source	160	
		0mA < I <sub>OUT</sub> < 10mA, sink	OUT2F	80	185	
				0mA < I <sub>OUT</sub> < 10mA, source	75	

**MAX6072\_50 Electrical Characteristics (V<sub>REF1</sub>: V<sub>OUT1F</sub> = 5V, V<sub>REF2</sub>: V<sub>OUT2F</sub> = 2.5V)  
(continued)**

(V<sub>IN1</sub> = V<sub>EN1</sub> = V<sub>IN2</sub> = V<sub>EN2</sub> = +5.5V, I<sub>OUT</sub> = 0mA, C<sub>OUT</sub> = 0.1μF, T<sub>A</sub> = -40°C to +125°C, unless otherwise noted. Typical values are at T<sub>A</sub> = +25°C.) (Note 2)

PARAMETER	SYMBOL	CONDITIONS		MIN	TYP	MAX	UNITS
Dropout Voltage		I <sub>OUT</sub> = 10mA, T <sub>A</sub> = -40°C to +125°C	OUT1F (Note 6)	60	150		mV
			OUT2F (Note 4)	110	230		
Output Current (OUT1F and OUT2F)	I <sub>OUT</sub>			-10		+10	mA
Short-Circuit Current (OUT1F and OUT2F)	I <sub>SC</sub>	Sourcing to ground		25			mA
		Sinking from V <sub>IN</sub>		25			
Thermal Hysteresis (Note 5)		OUT1F		85			ppm
		OUT2F		85			
Thermal Hysteresis Tracking (Note 5)		OUT2F to OUT1F		2.5			ppm
Long-Term Stability		OUT1F, 1000 hours at T <sub>A</sub> = +25°C		15			ppm
		OUT2F, 1000 hours at T <sub>A</sub> = +25°C		15			
Long-Term Drift Tracking				5			ppm
<b>DYNAMIC CHARACTERISTICS</b>							
Noise Voltage	e <sub>OUT</sub>	1/f noise, 0.1Hz to 10Hz, C <sub>OUT</sub> = 0.1μF	OUT1F	9			μV <sub>P-P</sub>
			OUT2F	4.8			
		Thermal noise, 10Hz to 10kHz, C <sub>OUT</sub> = 0.1μF	OUT1F	15			μV <sub>RMS</sub>
			OUT2F	6			
Noise Voltage Spectral Density		Thermal noise, f= 1kHz, C <sub>OUT</sub> = 0.1μF	OUT1F	120			nV/√Hz
			OUT2F	60			
Ripple Rejection		Frequency = 60Hz	OUT1F	74			dB
			OUT2F	84			
Turn- On Settling Time	t <sub>R</sub>	Settling to 0.01%, C <sub>OUT</sub> = 0.1μF	OUT1F	50			μs
			OUT2F	30			
Enable Settling Time	t <sub>EN</sub>	Settling to 0.01%, C <sub>OUT</sub> = 0.1μF	OUT1F	100			μs
			OUT2F	75			

**MAX6072\_50 Electrical Characteristics (V<sub>REF1</sub>: V<sub>OUT1F</sub> = 5V, V<sub>REF2</sub>: V<sub>OUT2F</sub> = 2.5V)  
(continued)**

(V<sub>IN1</sub> = V<sub>EN1</sub> = V<sub>IN2</sub> = V<sub>EN2</sub> = +5.5V, I<sub>OUT</sub> = 0mA, C<sub>OUT</sub> = 0.1μF, T<sub>A</sub> = -40°C to +125°C, unless otherwise noted. Typical values are at T<sub>A</sub> = +25°C.) (Note 2)

PARAMETER	SYMBOL	CONDITIONS	MIN	TYP	MAX	UNITS
Capacitive-Load Stability Range (OUT1F, OUT2F)		I <sub>OUT</sub> ≤ 10mA	0.1		10	μF
<b>INPUT (IN1 and IN2)</b>						
Supply Voltage	V <sub>IN</sub>	Guaranteed by line regulation	OUT1F	5.2	5.5	V
			OUT2F	2.8	5.5	
REF1 Quiescent Supply Current	I <sub>IN</sub>	T <sub>A</sub> = +25°C		160	270	μA
		T <sub>A</sub> = -40°C to +125°C			350	
REF2 Quiescent Supply Current	I <sub>IN</sub>	T <sub>A</sub> = +25°C		150	245	μA
		T <sub>A</sub> = -40°C to +125°C			320	
Shutdown Supply Current per Reference	I <sub>SD</sub>	V <sub>EN</sub> = 0V		0.85	28	μA
<b>ENABLE (EN1 and En2)</b>						
Enable Input Current	I <sub>EN</sub>		-1		+1	μA
Enable Logic- High	V <sub>IH</sub>		0.7 x V <sub>IN</sub>			V
Enable Logic- Low	V <sub>IL</sub>				0.3 x V <sub>IN</sub>	V

**MAX6072\_41 Electrical Characteristics (V<sub>REF1</sub>: V<sub>OUT1F</sub> = 4.096V, V<sub>REF2</sub>: V<sub>OUT2F</sub> = 2.048V)**

(V<sub>IN1</sub> = V<sub>EN1</sub> = V<sub>IN2</sub> = V<sub>EN2</sub> = +5V, I<sub>OUT</sub> = 0mA, C<sub>OUT</sub> = 0.1μF, T<sub>A</sub> = -40°C to +125°C, unless otherwise noted. Typical values are at T<sub>A</sub> = +25°C.) (Note 2)

PARAMETER	SYMBOL	CONDITIONS	MIN	TYP	MAX	UNITS	
<b>OUTPUT</b>							
Output Voltage Accuracy (OUT1F and OUT2F)		MAX6072A_41, T <sub>A</sub> = +25°C	-0.05		+0.05	%	
		MAX6072B_41, T <sub>A</sub> = +25°C	-0.08		+0.08		
Output Voltage Temperature Drift (OUT1F and OUT2F) (Note 3)	TCV <sub>OUT</sub>	MAX6072A_41		1.5	6	ppm/°C	
		MAX6072B_41		2.0	8		
Output Voltage Temperature Drift Tracking (OUT1F and OUT2F) (Note 3)	ΔTC	MAX6072A_41		0.4		ppm/°C	
		MAX6072B_41		0.4			
Line Regulation		OUT1F, 4.3V < V <sub>IN1</sub> < 5.5V	T <sub>A</sub> = +25°C		100	450	μV/V
			T <sub>A</sub> = -40°C to +125°C			485	
		OUT2F, 2.7V < V <sub>IN2</sub> < 5.5V	T <sub>A</sub> = +25°C		50	250	
			T <sub>A</sub> = -40°C to +125°C			270	

**MAX6072\_41 Electrical Characteristics (V<sub>REF1</sub>: V<sub>OUT1F</sub> = 4.096V, V<sub>REF2</sub>: V<sub>OUT2F</sub> = 2.048V) (continued)**

(V<sub>IN1</sub> = V<sub>EN1</sub> = V<sub>IN2</sub> = V<sub>EN2</sub> = +5V, I<sub>OUT</sub> = 0mA, C<sub>OUT</sub> = 0.1μF, T<sub>A</sub> = -40°C to +125°C, unless otherwise noted. Typical values are at T<sub>A</sub> = +25°C.) (Note 2)

PARAMETER	SYMBOL	CONDITIONS		MIN	TYP	MAX	UNITS
Load Regulation		0mA < I <sub>OUT</sub> < 10mA, sink	OUT1F		125	260	μV/mA
		0mA < I <sub>OUT</sub> < 10mA, source			135	300	
		0mA < I <sub>OUT</sub> < 10mA, sink	OUT2F		135	260	
		0mA < I <sub>OUT</sub> < 10mA, source			135	250	
Dropout Voltage		I <sub>OUT</sub> = 10mA, T <sub>A</sub> = -40°C to +125°C (Note 6)	OUT1F		75	150	mV
Output Current (OUT1F and OUT2F)	I <sub>OUT</sub>			-10		+10	mA
Short-Circuit Current (OUT1F and OUT2F)	I <sub>SC</sub>	Sourcing to ground			25		mA
		Sinking from V <sub>IN</sub>			25		
Thermal Hysteresis (Note 5)		OUT1F			85		ppm
		OUT2F			85		
Thermal Hysteresis Tracking (Note 5)		OUT2F to OUT1F			2.5		ppm
Long-Term Stability		OUT1F, 1000 hours at T <sub>A</sub> = +25°C			15		ppm
		OUT2F, 1000 hours at T <sub>A</sub> = +25°C			15		
Long-Term Drift Matching					5		ppm
<b>DYNAMIC CHARACTERISTICS</b>							
Noise Voltage	e <sub>OUT</sub>	1/f noise, 0.1Hz to 10Hz, C <sub>OUT</sub> = 0.1μF	OUT1F		9.6		μV <sub>P-P</sub>
			OUT2F		6.4		
		Thermal noise, 10Hz to 10kHz, C <sub>OUT</sub> = 0.1μF	OUT1F		12		μV <sub>RMS</sub>
			OUT2F		8.6		

**MAX6072\_41 Electrical Characteristics (V<sub>REF1</sub>: V<sub>OUT1F</sub> = 4.096V, V<sub>REF2</sub>: V<sub>OUT2F</sub> = 2.048V) (continued)**

(V<sub>IN1</sub> = V<sub>EN1</sub> = V<sub>IN2</sub> = V<sub>EN2</sub> = +5V, I<sub>OUT</sub> = 0mA, C<sub>OUT</sub> = 0.1μF, T<sub>A</sub> = -40°C to +125°C, unless otherwise noted. Typical values are at T<sub>A</sub> = +25°C.) (Note 2)

PARAMETER	SYMBOL	CONDITIONS	MIN	TYP	MAX	UNITS
Noise Voltage Spectral Density		Thermal noise, f= 1kHz, C <sub>OUT</sub> = 0.1μF	OUT1F	110		nV/√Hz
			OUT2F	75		
Ripple Rejection		Frequency = 60Hz	OUT1F	80		dB
			OUT2F	86		
Turn- On Settling Time	t <sub>R</sub>	Settling to 0.01%, C <sub>OUT</sub> = 0.1μF	OUT1F	40		μs
			OUT2F	25		
Enable Settling Time	t <sub>EN</sub>	Settling to 0.01%, C <sub>OUT</sub> = 0.1μF	OUT1F	85		μs
			OUT2F	65		
Capacitive- Load Stability Range (OUT1F, OUT2F)		I <sub>OUT</sub> ≤ 10mA	0.1		10	μF
<b>INPUT (IN1 and IN2)</b>						
Supply Voltage	V <sub>IN</sub>	Guaranteed by line regulation	OUT1F	4.3	5.5	V
			OUT2F	2.7	5.5	
REF1 Quiescent Supply Current	I <sub>IN</sub>	T <sub>A</sub> = +25°C		150	265	μA
		T <sub>A</sub> = -40°C to +125°C			350	
REF2 Quiescent Supply Current	I <sub>IN</sub>	T <sub>A</sub> = +25°C		130	220	μA
		T <sub>A</sub> = -40°C to +125°C			280	
Shutdown Supply Current per Reference	I <sub>SD</sub>	V <sub>EN</sub> = 0V		0.85	28	μA
<b>ENABLE (EN1 and EN2)</b>						
Enable Input Current	I <sub>EN</sub>		-1		+1	μA
Enable Logic- High	V <sub>IH</sub>		0.7 x V <sub>IN</sub>			V
Enable Logic- Low	V <sub>IL</sub>			0.3 x V <sub>IN</sub>		V

**MAX6072\_25 Electrical Characteristics (V<sub>REF1</sub>: V<sub>OUT1F</sub> = 2.5V, V<sub>REF2</sub>: V<sub>OUT2F</sub> = 1.25V)**

(V<sub>IN1</sub> = V<sub>EN1</sub> = V<sub>IN2</sub> = V<sub>EN2</sub> = +5V, I<sub>OUT</sub> = 0mA, C<sub>OUT</sub> = 0.1μF, T<sub>A</sub> = -40°C to +125°C, unless otherwise noted. Typical values are at T<sub>A</sub> = +25°C.) (Note 2)

PARAMETER	SYMBOL	CONDITIONS	MIN	TYP	MAX	UNITS
<b>OUTPUT</b>						
Output Voltage Accuracy (OUT1F and OUT2F)		MAX6072A_25, T <sub>A</sub> = +25°C	-0.05		+0.05	%
		MAX6072B_25, T <sub>A</sub> = +25°C	-0.08		+0.08	
Output Voltage Temperature Drift (OUT1F and OUT2F, Note 3)	TCV <sub>OUT</sub>	MAX6072A_25		1.5	6	ppm/°C
		MAX6072B_25		2.0	8	
Output Voltage Temperature Drift Tracking (OUT1F and OUT2F) (Note 3)	ΔTC	MAX6072A_25		0.4		ppm/°C
		MAX6072B_25		0.4		
Line Regulation		OUT1F, 2.8V < V <sub>IN1</sub> < 5.5V	T <sub>A</sub> = +25°C	60	260	μV/V
			T <sub>A</sub> = -40°C to +125°C		275	
		OUT2F, 2.75V < V <sub>IN2</sub> < 5.5V	T <sub>A</sub> = +25°C	13	190	
			T <sub>A</sub> = -40°C to +125°C		200	
Load Regulation		0mA < I <sub>OUT</sub> < 10mA, sink	OUT1F	80	185	μV/mA
				75	190	
		0mA < I <sub>OUT</sub> < 10mA, source	OUT2F	70	185	
				100	190	
Dropout Voltage		I <sub>OUT</sub> = 10mA, T <sub>A</sub> = -40°C to +125°C (Note 6)	OUT1F	110	230	mV
Output Current (OUT1F and OUT2F)	I <sub>OUT</sub>		-10		+10	mA
Short-Circuit Current (OUT1F and OUT2F)	I <sub>SC</sub>	Sourcing to ground		25		mA
		Sinking from V <sub>IN</sub>		25		
Thermal Hysteresis (Note 5)		OUT1F		85		ppm
		OUT2F		85		
Thermal Hysteresis Tracking (Note 5)		OUT2F to OUT1F		2.5		ppm
Long-Term Stability		OUT1F, 1000 hours at T <sub>A</sub> = +25°C		15		ppm
		OUT2F, 1000 hours at T <sub>A</sub> = +25°C		20		

**MAX6072\_25 Electrical Characteristics (V<sub>REF1</sub>: V<sub>OUT1F</sub> = 2.5V, V<sub>REF2</sub>: V<sub>OUT2F</sub> = 1.25V)  
(continued)**

(V<sub>IN1</sub> = V<sub>EN1</sub> = V<sub>IN2</sub> = V<sub>EN2</sub> = +5V, I<sub>OUT</sub> = 0mA, C<sub>OUT</sub> = 0.1μF, T<sub>A</sub> = -40°C to +125°C, unless otherwise noted. Typical values are at T<sub>A</sub> = +25°C.) (Note 2)

PARAMETER	SYMBOL	CONDITIONS	MIN	TYP	MAX	UNITS
Long-Term Drift Tracking				7		ppm
<b>DYNAMIC CHARACTERISTICS</b>						
Noise Voltage	e <sub>OUT</sub>	1/f noise, 0.1Hz to 10Hz, C <sub>OUT</sub> = 0.1μF	OUT1F	4.8		μV <sub>P-P</sub>
			OUT2F	3.6		
		Thermal noise, 10Hz to 10kHz, C <sub>OUT</sub> = 0.1μF	OUT1F	6		μV <sub>RMS</sub>
			OUT2F	5		
Noise Voltage Spectral Density		Thermal noise, f = 1kHz, C <sub>OUT</sub> = 0.1μF	OUT1F	60		nV/√Hz
			OUT2F	50		
Ripple Rejection		Frequency = 60Hz	OUT1F	84		dB
			OUT2F	100		
Turn-On Settling Time	t <sub>R</sub>	Settling to 0.01%, C <sub>OUT</sub> = 0.1μF	OUT1F	30		μs
			OUT2F	20		
Enable Settling Time	t <sub>EN</sub>	Settling to 0.01%, C <sub>OUT</sub> = 0.1μF	OUT1F	75		μs
			OUT2F	60		
Capacitive-Load Stability Range (OUT1F, OUT2F)		I <sub>OUT</sub> ≤ 10mA	0.1		10	μF
<b>INPUT (IN1 and IN2)</b>						
Supply Voltage	V <sub>IN</sub>	Guaranteed by line regulation	OUT1F	2.8	5.5	V
			OUT2F	2.75	5.5	
REF1 Quiescent Supply Current	I <sub>IN</sub>	T <sub>A</sub> = +25°C		150	245	μA
		T <sub>A</sub> = -40°C to +125°C			320	
REF2 Quiescent Supply Current	I <sub>IN</sub>	T <sub>A</sub> = +25°C		130	210	μA
		T <sub>A</sub> = -40°C to +125°C			260	
Shutdown Supply Current per Reference	I <sub>SD</sub>	V <sub>EN</sub> = 0V		0.6	28	μA



**MAX6072\_25 Electrical Characteristics (V<sub>REF1</sub>: V<sub>OUT1F</sub> = 2.5V, V<sub>REF2</sub>: V<sub>OUT2F</sub> = 1.25V)  
(continued)**

(V<sub>IN1</sub> = V<sub>EN1</sub> = V<sub>IN2</sub> = V<sub>EN2</sub> = +5V, I<sub>OUT</sub> = 0mA, C<sub>OUT</sub> = 0.1μF, T<sub>A</sub> = -40°C to +125°C, unless otherwise noted. Typical values are at T<sub>A</sub> = +25°C.) (Note 2)

PARAMETER	SYMBOL	CONDITIONS	MIN	TYP	MAX	UNITS
<b>ENABLE (EN1 and EN2)</b>						
Enable Input Current	I <sub>EN</sub>		-1		+1	μA
Enable Logic-High	V <sub>IH</sub>		0.7 x V <sub>INL</sub>			V
Enable Logic-Low	V <sub>IL</sub>			0.3 x V <sub>INL</sub>		V

- Note 2:** All devices are 100% production tested at T<sub>A</sub> = +25°C. Specifications over the entire operating temperature range are guaranteed by design and characterization. Typical specifications are at T<sub>A</sub> = +25°C.
- Note 3:** Temperature coefficient is calculated using the “box method” which measures temperature drift as the maximum voltage variation over a specified temperature range. The unit of measurement is ppm/°C.  
Temperature coefficient matching (ΔTC) is calculated using the “box method” which measures temperature drift as the maximum variation of the difference between the normalized output voltages, V<sub>OUT2\_NORM</sub> and V<sub>OUT1\_NORM</sub> (over a specified temperature range). The unit of measurement is ppm/°C, V<sub>OUT\_NORM</sub> = [(V<sub>OUT</sub>(T) - V<sub>OUT</sub>(25°C))/V<sub>OUT</sub>(25°C)]
- Note 4:** Dropout voltage is defined as the minimum differential voltage (V<sub>IN</sub> - V<sub>OUT</sub>) at which V<sub>OUT</sub> decreases by 0.2% from its original value at V<sub>IN</sub> = 5.0V.
- Note 5:** Thermal hysteresis is defined as the change in +25°C output voltage before and after cycling the device from T<sub>MAX</sub> to T<sub>MIN</sub>. Thermal hysteresis matching is defined as the difference of the thermal hysteresis for each output (OUT1 and OUT2): ΔTH = TH<sub>OUT2</sub> - TH<sub>OUT1</sub>
- Note 6:** Dropout voltage is defined as the minimum differential voltage (V<sub>IN</sub> - V<sub>OUT</sub>) at which V<sub>OUT</sub> decreases by 0.2% from its original value at V<sub>IN</sub> = 5.5V.

Typical Operating Characteristics

( $V_{IN1} = V_{IN2} = V_{EN1} = V_{EN2} = +5.5V$  (MAX6072\_50),  $V_{IN1} = V_{IN2} = V_{EN1} = V_{EN2}$  (MAX6072\_41 and MAX6072\_25),  $I_{OUT} = 0mA$ ,  $C_{OUT} = 0.1\mu F$ ,  $T_A = +25^\circ C$ , unless otherwise noted.)

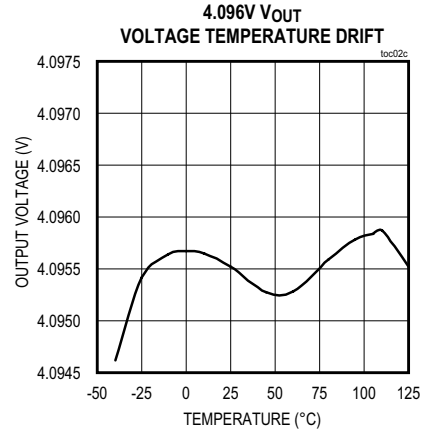
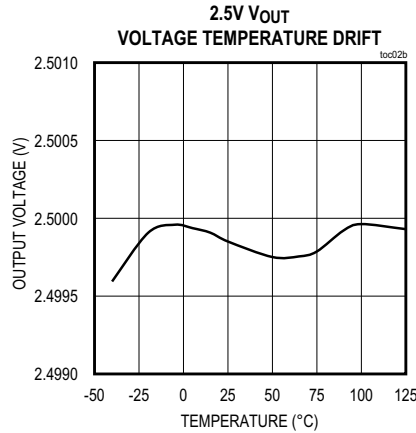
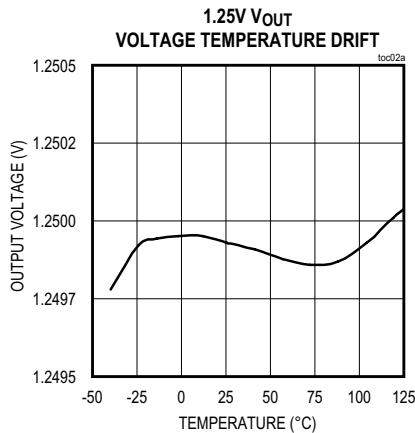
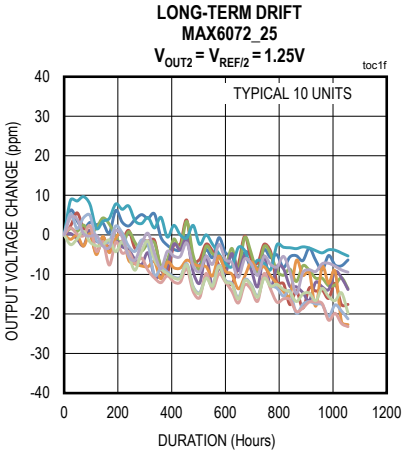
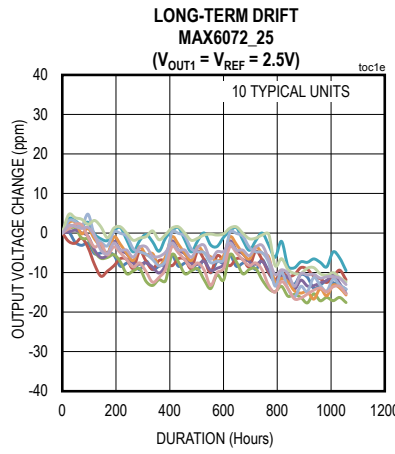
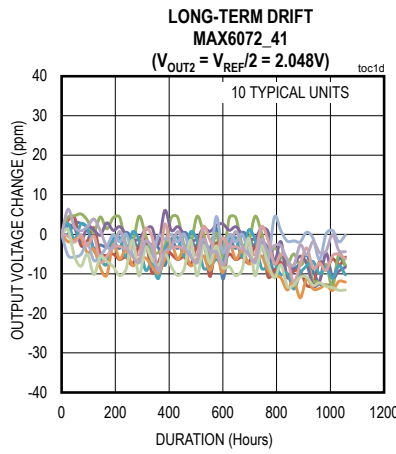
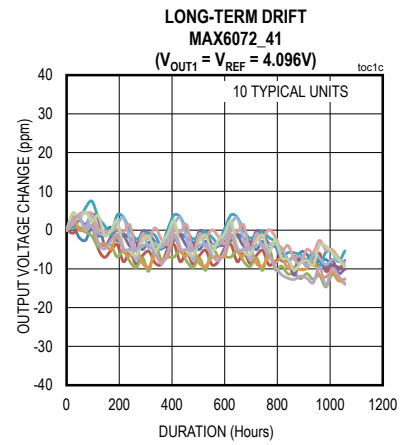
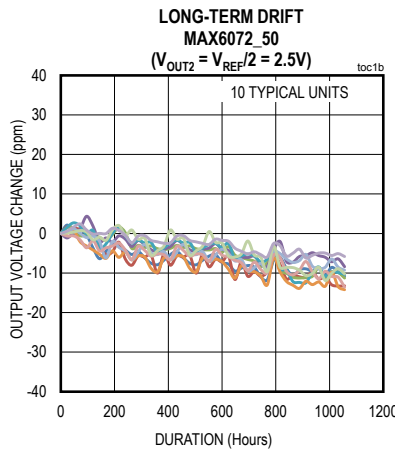
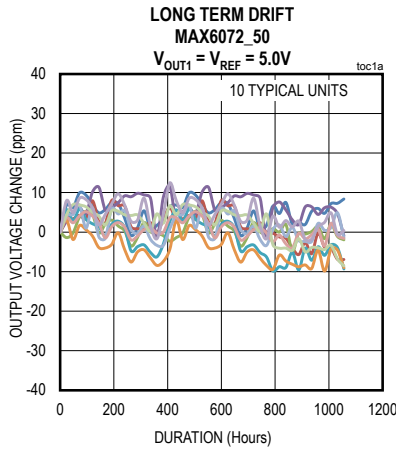

Typical Operating Characteristics (continued)

( $V_{IN1} = V_{IN2} = V_{EN1} = V_{EN2} = +5.5V$  (MAX6072\_50),  $V_{IN1} = V_{IN2} = V_{EN1} = V_{EN2}$  (MAX6072\_41 and MAX6072\_25),  $I_{OUT} = 0mA$ ,  $C_{OUT} = 0.1\mu F$ ,  $T_A = +25^\circ C$ , unless otherwise noted.)

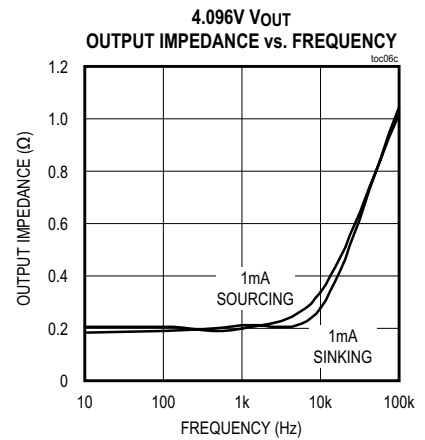
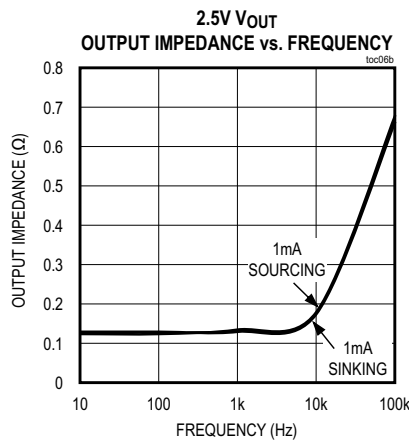
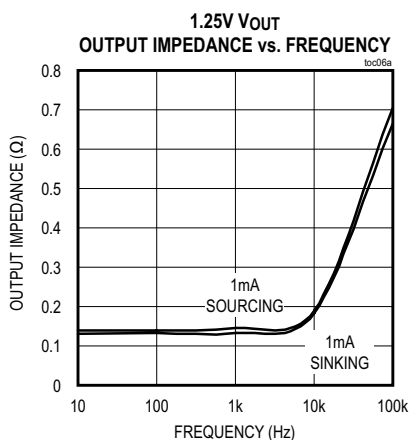
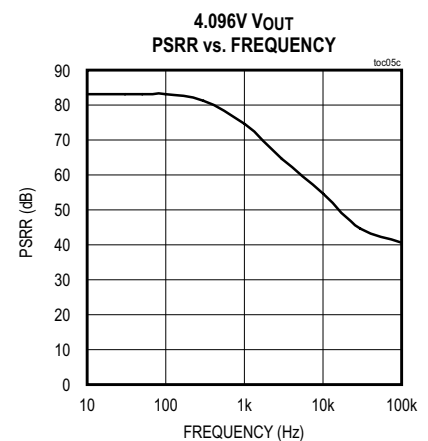
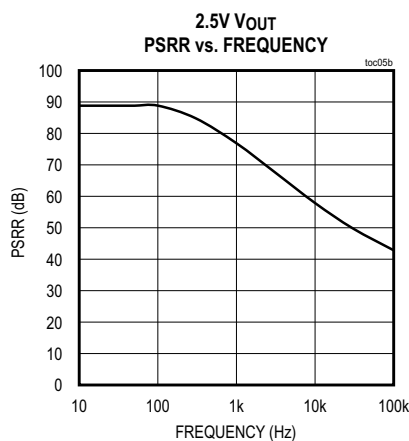
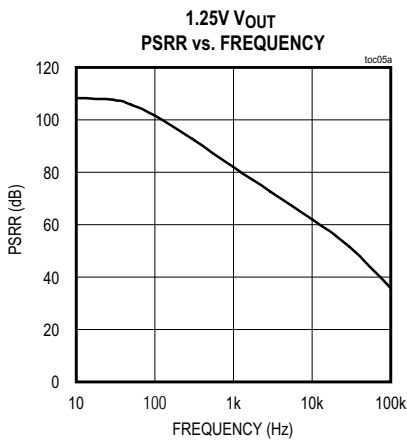
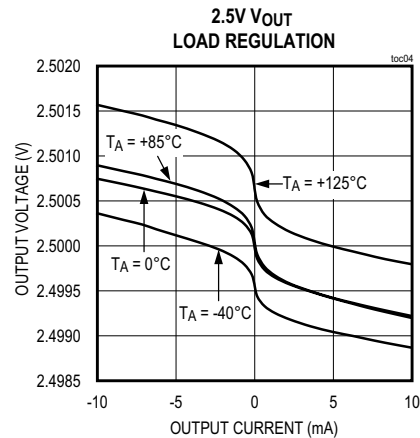
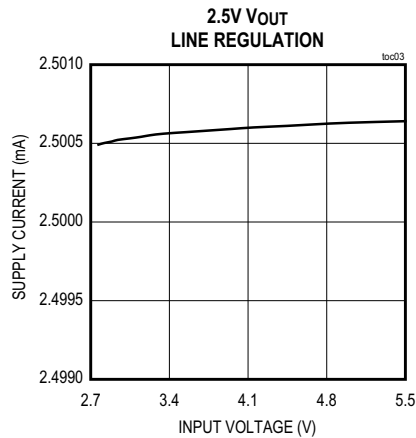

Typical Operating Characteristics (continued)

( $V_{IN1} = V_{IN2} = V_{EN1} = V_{EN2} = +5.5V$  (MAX6072\_50),  $V_{IN1} = V_{IN2} = V_{EN1} = V_{EN2}$  (MAX6072\_41 and MAX6072\_25),  $I_{OUT} = 0mA$ ,  $C_{OUT} = 0.1\mu F$ ,  $T_A = +25^\circ C$ , unless otherwise noted.)

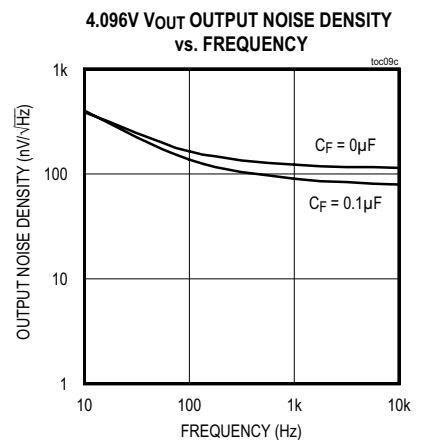
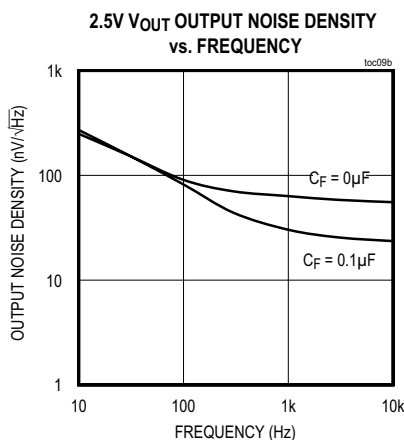
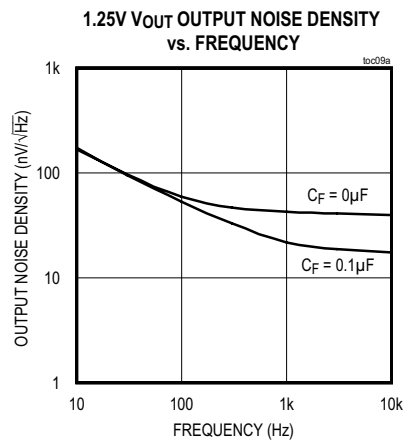
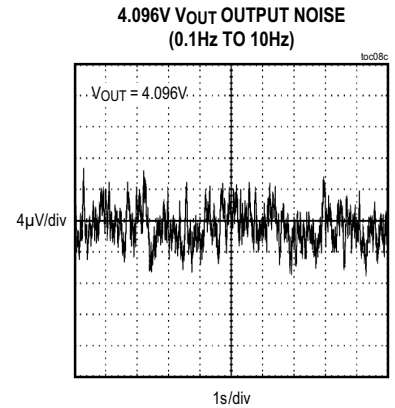
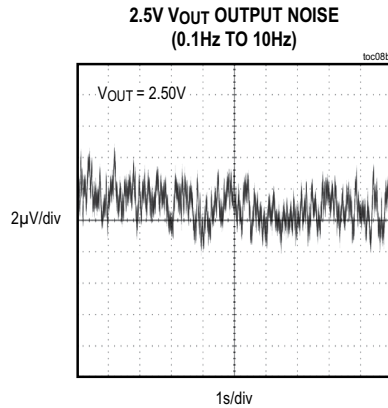
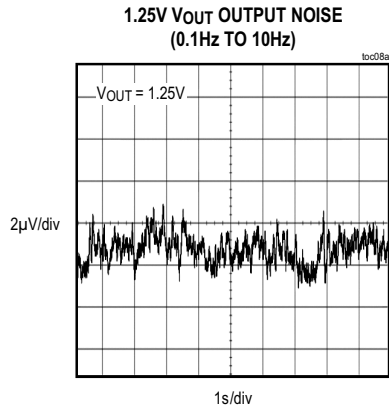
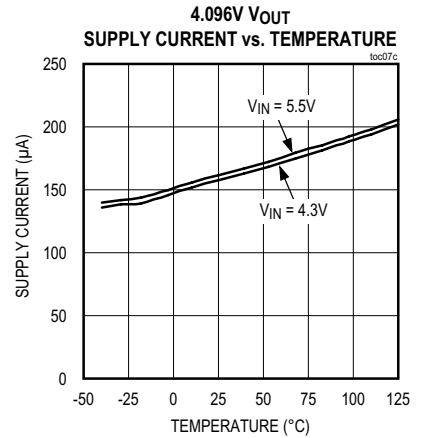
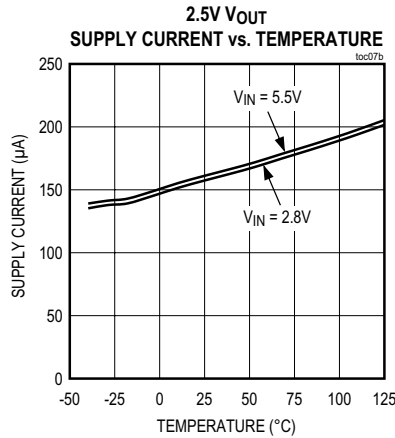
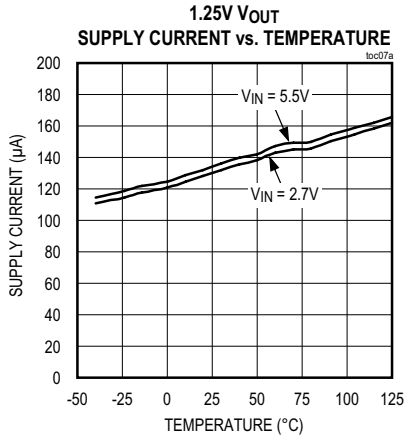

Typical Operating Characteristics (continued)

( $V_{IN1} = V_{IN2} = V_{EN1} = V_{EN2} = +5.5V$  (MAX6072\_50),  $V_{IN1} = V_{IN2} = V_{EN1} = V_{EN2}$  (MAX6072\_41 and MAX6072\_25),  $I_{OUT} = 0mA$ ,  $C_{OUT} = 0.1\mu F$ ,  $T_A = +25^\circ C$ , unless otherwise noted.)

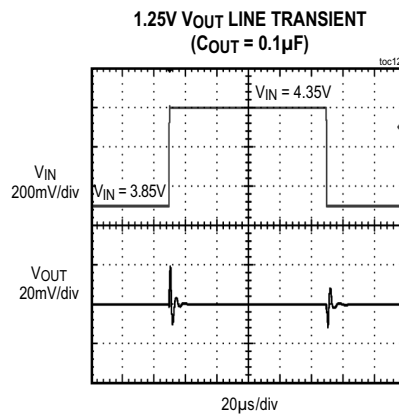
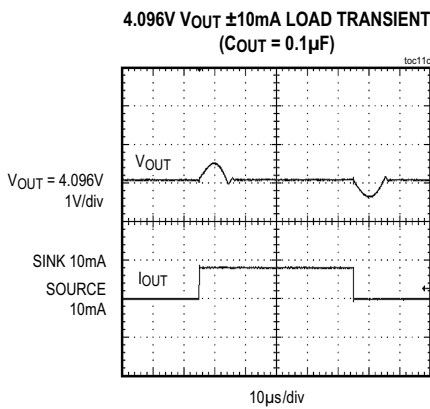
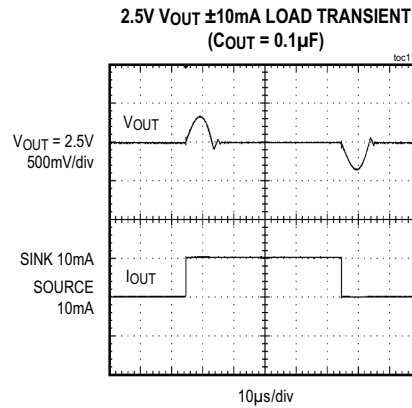
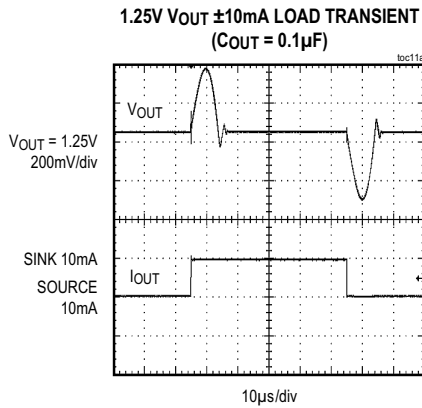
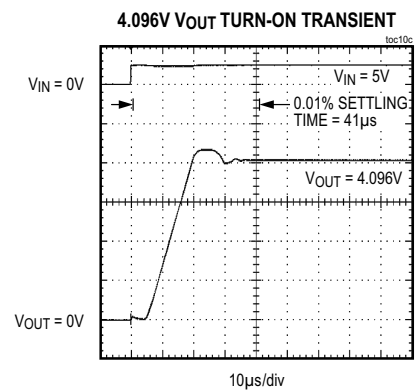
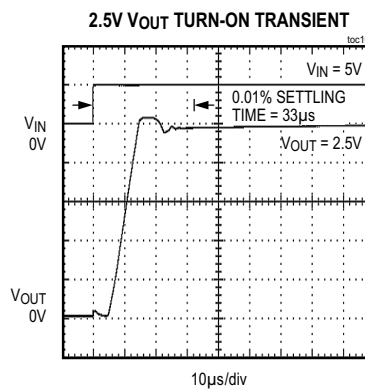
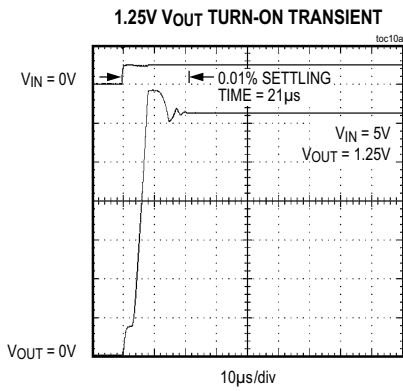

Typical Operating Characteristics (continued)

( $V_{IN1} = V_{IN2} = V_{EN1} = V_{EN2} = +5.5V$  (MAX6072\_50),  $V_{IN1} = V_{IN2} = V_{EN1} = V_{EN2}$  (MAX6072\_41 and MAX6072\_25),  $I_{OUT} = 0mA$ ,  $C_{OUT} = 0.1\mu F$ ,  $T_A = +25^\circ C$ , unless otherwise noted.)

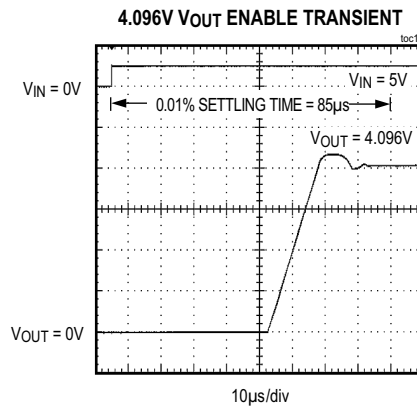
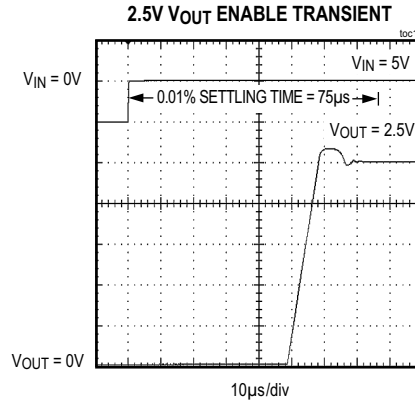
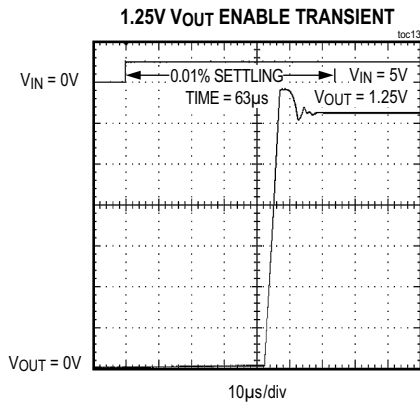
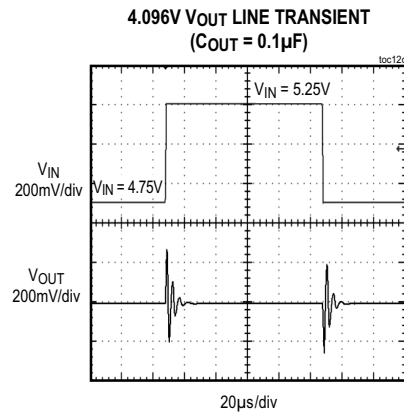
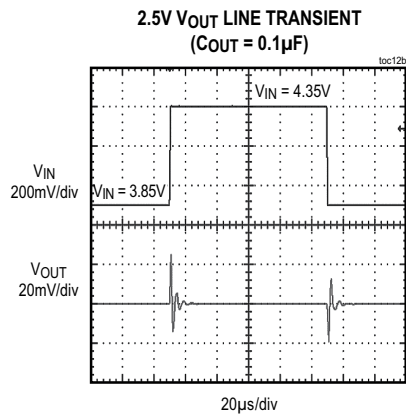

Pin Configuration

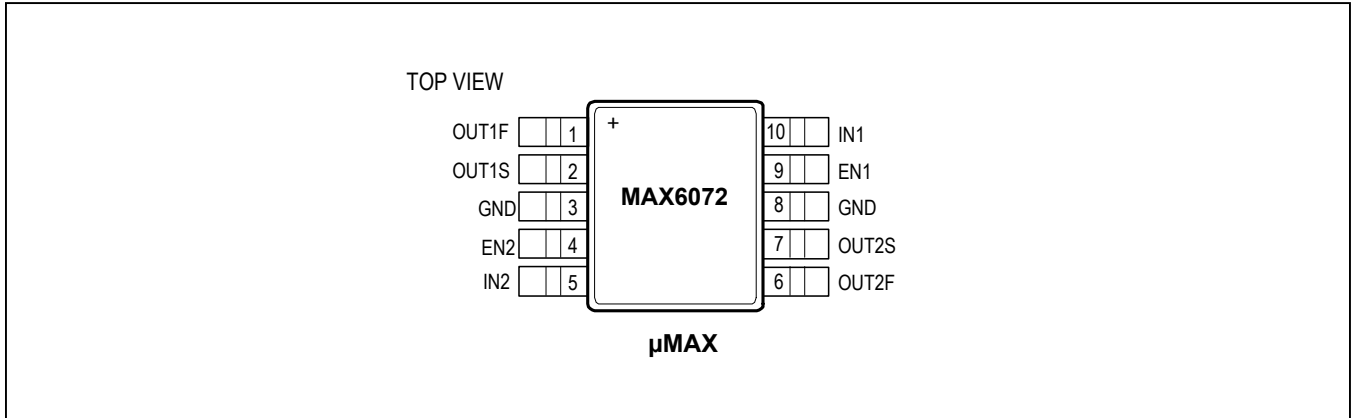

Pin Description

PIN	NAME	FUNCTION
1	OUT1F	$V_{REF}$ Reference 1 ( $V_{OUT1F}$ ) Force Output. Short OUT1F to OUT1S as close as possible to the load. Bypass with a capacitor (0.1 $\mu$ F to 10 $\mu$ F) to GND.
2	OUT1S	$V_{REF}$ Voltage Reference 1 ( $V_{OUT1S}$ ) Sense
3, 8	GND	Ground. Both the pins 3 and 8 must be externally connected to a solid ground plane.
4	EN2	Voltage Reference 2 Enable Input. Drive high to enable $V_{REF2}$ . Drive low to disable $V_{REF2}$ .
5	IN2	Voltage Reference 2 Supply Input
6	OUT2F	$V_{REF}/2$ Voltage Reference 2 ( $V_{OUT2F}$ ) Force Output. Short OUT2F to OUT2S as close as possible to the load. Bypass with a capacitor (0.1 $\mu$ F to 10 $\mu$ F) to GND.
7	OUT2S	$V_{REF}/2$ Voltage Reference 2 ( $V_{OUT2S}$ ) Sense
9	EN1	Voltage Reference 1 Enable Input. Drive high to enable $V_{REF1}$ . Drive low to disable $V_{REF1}$ .
10	IN1	Voltage Reference 1 Supply Input

Functional Diagram

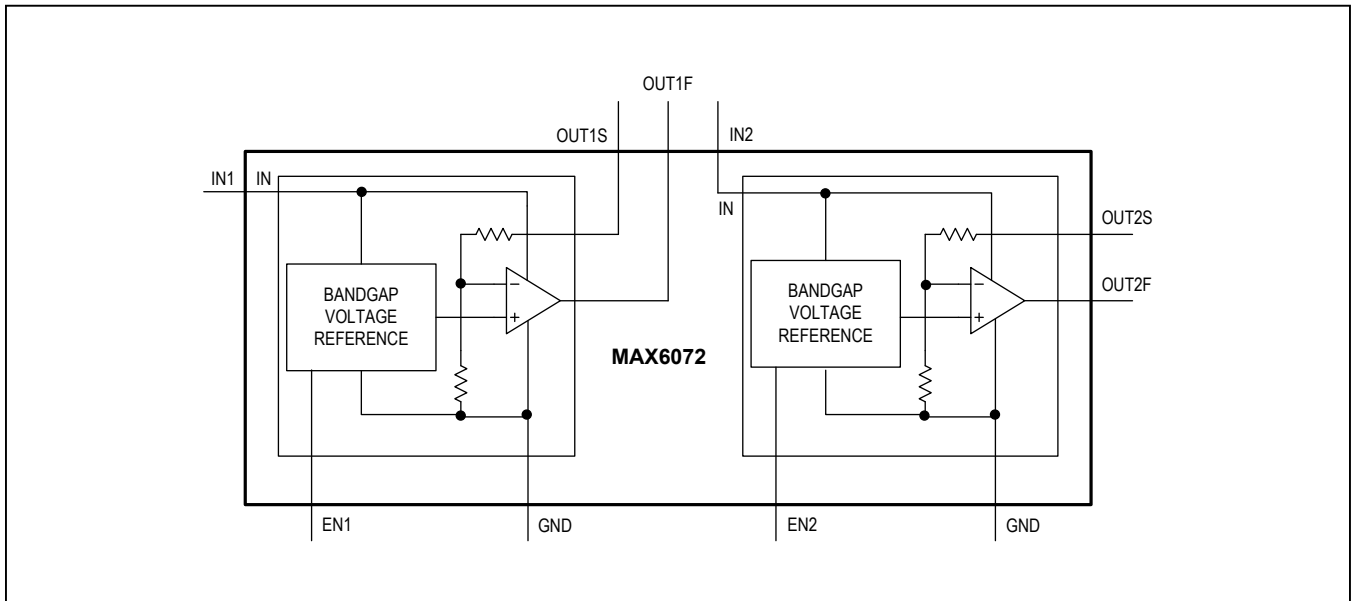

Detailed Description

Output Force and Sense

The MAX6072 provides independent Kelvin connections for the power-circuit output (OUTF) supplying current to the load and the circuit input regulating the voltage applied to that load (OUTS). This configuration allows for the cancellation of the voltage drop on the lines connecting the MAX6072 and the load. When using the Kelvin connection made possible by the independent current and voltage connections, connect OUTF to the load and connect OUTS to OUTF at the point where the voltage accuracy is most needed (see [Figure 1](#)).

Output Bypassing

The MAX6072 requires an output capacitor between 0.1µF and 10µF. Place the output capacitor as close to OUT\_F as possible. For applications driving switching capacitive loads or rapidly changing load currents, use a 10µF capacitor in parallel with a 0.1µF capacitor. Larger capacitor values reduce transients on the reference output.

Supply Voltage

Each of the MAX6072 references offers individual supply voltage inputs (IN1 and IN2). IN1 supplies the power to VREF1 and IN2 for VREF2. Each of the two references can be powered up separately or from the same supply voltage by shorting IN1 and IN2 together.

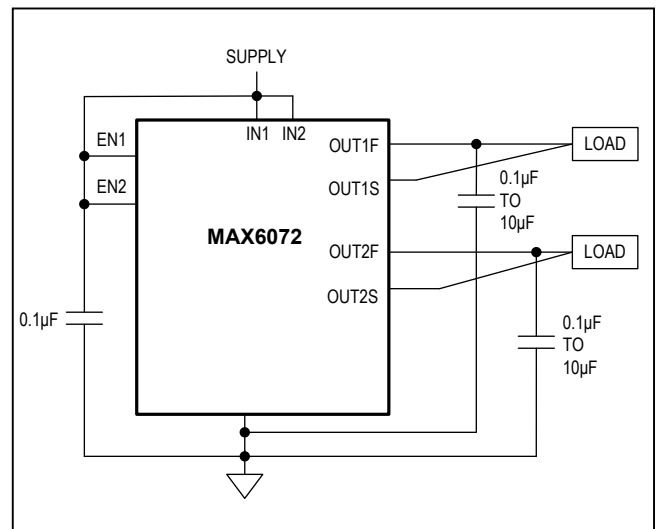

Figure 1. Reference Output Kelvin Connection



**Thermal Hysteresis**

Thermal hysteresis is the change of output voltage at  $T_A = +25^\circ\text{C}$  before and after the device is cycled over its entire operating temperature range. The typical thermal hysteresis value is 85ppm.

**Turn-On Time**

The device typically turns on and settles to within 0.01% of their final value in 25 $\mu\text{s}$  to 40 $\mu\text{s}$ . The turn-on time can increase up to 4ms with the device operating at the minimum dropout voltage and the maximum load.

**Applications Information**

**Accurate Reference by Using the Other Reference Output as the Supply Input**

In certain applications where only a single reference is required, the dual reference can be used as a single reference output when one of its references ( $V_{OUT1F}$  where  $V_{OUT1F} > V_{OUT2F}$ ) is used as the supply input for the second internal reference of the part (see Figure 2). By doing so, the output reference accuracy is improved as the PSRR performance improves. Since both the refer-

ences are present in the same package, they exhibit the same thermal trend in variation.

**Dual Referencing Fully Differential Amplifier and ADC**

Applications employing a fully differential amplifier and ADC in a signal chain typically require maintaining the input(s) at half the  $V_{REF}$  (V) for the common-mode voltage being applied to the ADC. For this purpose, either a second reference with the value  $V_{REF\_DIFF\_AMP} = V_{REF}/2$ , or an op amp is often used as output common-mode biasing. The MAX6072A/B series is used with ease in these situations, where  $V_{REF\_DIFF\_AMP}$  can be referenced from the  $V_{REF2}$  available from the part. This way, both the  $V_{REF}$  and  $V_{REF}/2$  to the ADC and the differential amplifier are provided by the same part providing improved accuracy and lesser board space. See [Figure 3](#).

The [Typical Operating Circuit](#) shows MAX6072A\_41 used in a signal chain, performing single-ended to differential conversion.

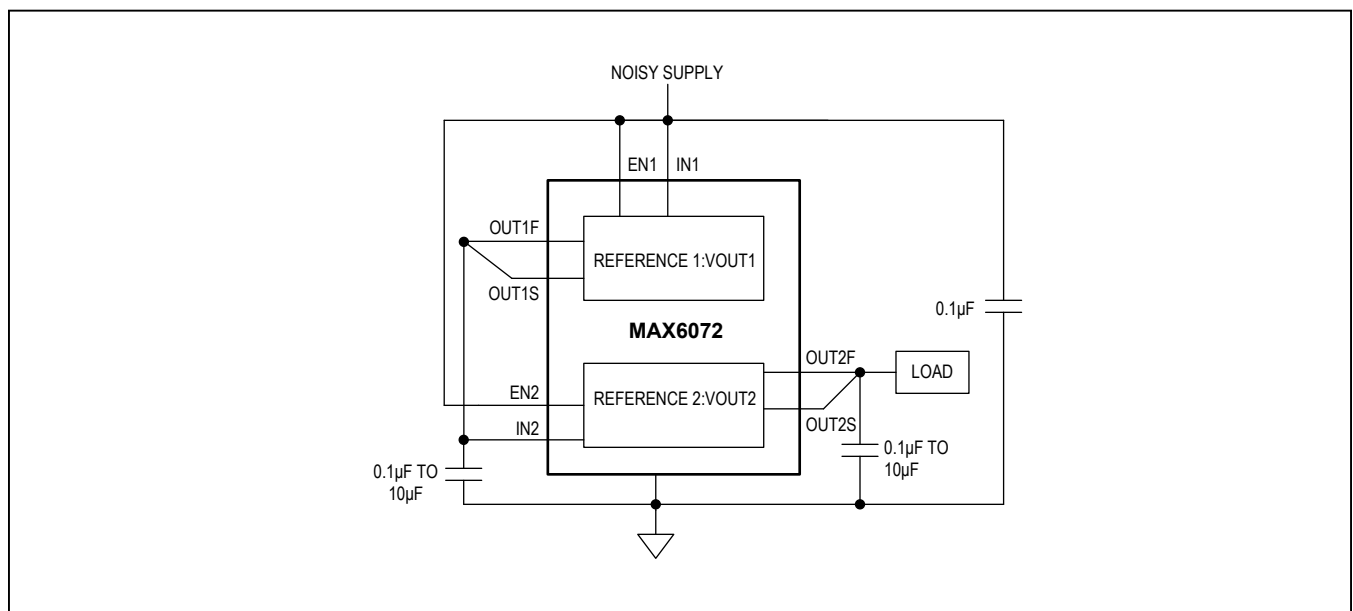

Figure 2. Increasing the Accuracy of Reference

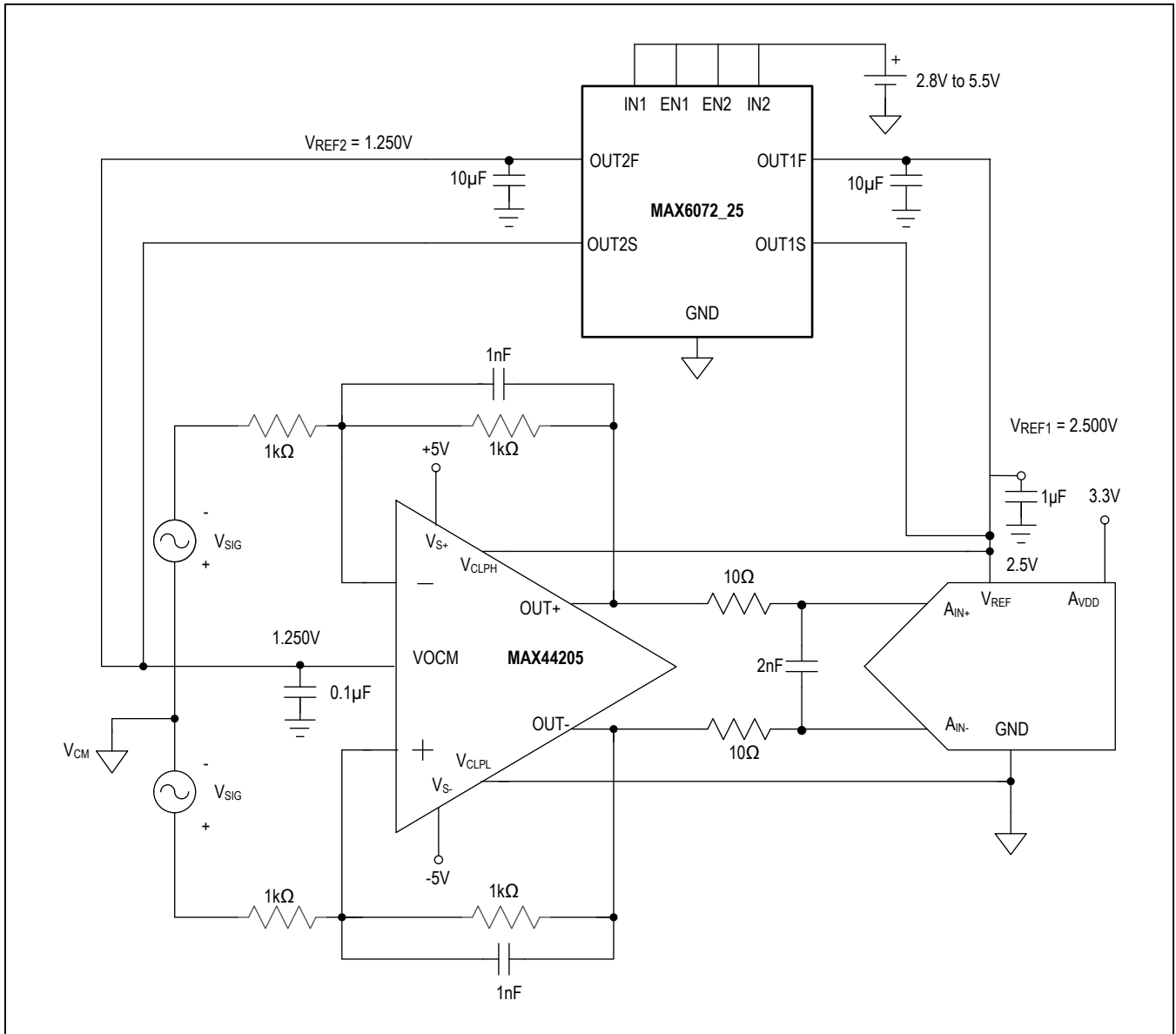
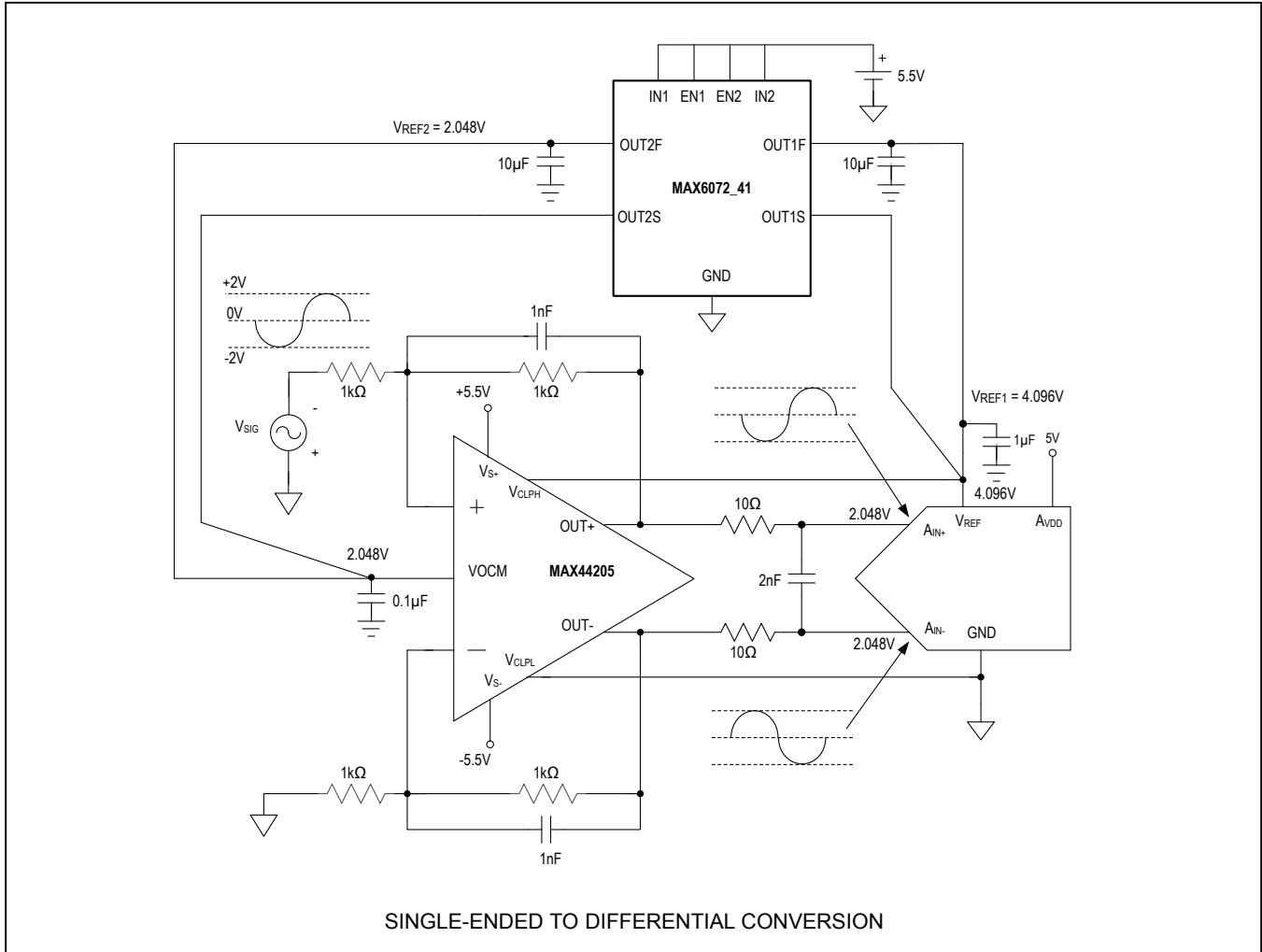

Figure 3. Fully Differential Amplifier and ADC with Dual Referencing from MAX6072\_25

Typical Operating Circuit



## Ordering Information

PART	PIN-PACKAGE	V <sub>REF1</sub> /V <sub>REF2</sub>
<b>MAX6072AAUB25+</b>	10 $\mu$ MAX	2.500V/1.250V
MAX6072AAUB41+	10 $\mu$ MAX	4.096V/2.048V
MAX6072AAUB50+	10 $\mu$ MAX	5.000V/2.500V
<b>MAX6072BAUB25+</b>	10 $\mu$ MAX	2.500V/1.250V
MAX6072BAUB41+	10 $\mu$ MAX	4.096V/2.048V
MAX6072BAUB50+	10 $\mu$ MAX	5.000V/2.500V

**Note:** All devices are specified over the  $-40^{\circ}\text{C}$  to  $+125^{\circ}\text{C}$  operating temperature range.

+Denotes a lead(Pb)-free/RoHS-compliant package.

## Chip Information

PROCESS: BiCMOS

## Package Information

For the latest package outline information and land patterns (footprints), go to [www.maximintegrated.com/packages](http://www.maximintegrated.com/packages). Note that a "+", "#", or "-" in the package code indicates RoHS status only. Package drawings may show a different suffix character, but the drawing pertains to the package regardless of RoHS status.

PACKAGE TYPE	PACKAGE CODE	OUTLINE NO.	LAND PATTERN NO.
10 $\mu$ MAX	U10M+5	<a href="#">21-0061</a>	<a href="#">90-0330</a>