

MAX6161–MAX6168

Precision, Micropower, Low-Dropout, High-Output-Current, SO-8 Voltage References

General Description

The MAX6161–MAX6168 are precision, low-dropout, micropower voltage references. These three-terminal devices operate with an input voltage range from ($V_{OUT} + 200\text{mV}$) to 12.6V and are available with output voltage options of 1.25V, 1.8V, 2.048V, 2.5V, 3V, 4.096V, 4.5V, and 5V. They feature a proprietary curvature-correction circuit and laser-trimmed thin-film resistors that result in a very low temperature coefficient of 5ppm/°C (max) and an initial accuracy of $\pm 2\text{mV}$ (max). Specifications apply to the extended temperature range (-40°C to $+85^\circ\text{C}$).

The MAX6161–MAX6168 typically draw only 100 μA of supply current and can source 5mA (4mA for MAX6161) or sink 2mA of load current. Unlike conventional shunt-mode (two-terminal) references that waste supply current and require an external resistor, these devices offer a supply current that is virtually independent of the supply voltage (8 $\mu\text{A}/\text{V}$ variation) and do not require an external resistor. Additionally, the internally compensated devices do not require an external compensation capacitor. Eliminating the external compensation capacitor saves valuable board area in space-critical applications. A low-dropout voltage and a supply-independent, ultra-low supply current make these devices ideal for battery-operated, high-performance, low-voltage systems.

The MAX6161–MAX6168 are available in 8-pin SO packages.

Benefits and Features

- $\pm 2\text{mV}$ (max) Initial Accuracy
- 5ppm/°C (max) Temperature Coefficient
- 5mA Source Current at 0.9mV/mA
- 2mA Sink Current at 2.5mV/mA
- Stable with 1 μF Capacitive Loads
- No External Capacitor Required
- 100 μA (typ) Quiescent Supply Current
- 200mV (max) Dropout at 1mA Load Current
- Output Voltage Options: 1.25V, 1.8V, 2.048V, 2.5V, 3V, 4.096V, 4.5V, 5V

Applications

- Analog-to-Digital Converters (ADCs)
- Portable Battery-Powered Systems
- Notebook Computers
- PDAs, GPS, DMMs
- Cellular Phones
- Precision +3V/+5V Systems

Ordering Information, Typical Operating Circuit, and Selector Guide appear at end of data sheet.

Pin Configuration

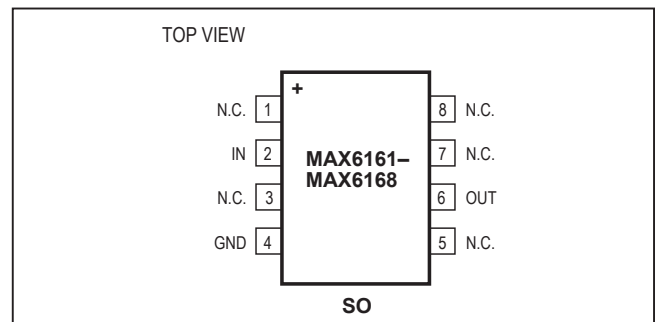

Absolute Maximum Ratings

Voltages Referenced to GND

IN	-0.3 to +13.5V
OUT	-0.3V to (V _{IN} + 0.3V)
Output Short-Circuit Duration to GND or IN (V _{IN} ≤ 6V)	Continuous
Output Short-Circuit Duration to GND or IN (V _{IN} > 6V)	60s

Continuous Power Dissipation (T_A = +70°C)

8-Pin SO (derate 5.88mW/°C above +70°C).....	471mW
Operating Temperature Range	-40°C to +85°C
Storage Temperature Range.....	-65°C to +150°C
Lead Temperature (soldering, 10s)	+300°C

Stresses beyond those listed under "Absolute Maximum Ratings" may cause permanent damage to the device. These are stress ratings only, and functional operation of the device at these or any other conditions beyond those indicated in the operational sections of the specifications is not implied. Exposure to absolute maximum rating conditions for extended periods may affect device reliability.

Electrical Characteristics—MAX6161 (V_{OUT} = 1.25V)

(V_{IN} = +5V, I_{OUT} = 0, T_A = T_{MIN} to T_{MAX}, unless otherwise specified. Typical values are at T_A = +25°C.) (Note 1)

PARAMETER	SYMBOL	CONDITIONS	MIN	TYP	MAX	UNITS	
Output Voltage	V _{OUT}	T _A = +25°C	MAX6161A	1.248	1.250	1.252	V
			MAX6161B	1.246	1.250	1.254	
Output Voltage Temperature Coefficient (Note 2)	TCV _{OUT}	MAX6161A		4	10	ppm/°C	
		MAX6161B		6	15		
Line Regulation	$\frac{\Delta V_{OUT}}{\Delta V_{IN}}$	2.5V ≤ V _{IN} ≤ 12.6V		12	150	μV/V	
Load Regulation	$\frac{\Delta V_{OUT}}{\Delta I_{OUT}}$	Sourcing: 0 ≤ I _{OUT} ≤ 4mA		0.5	0.9	mV/mA	
		Sinking: -2mA ≤ I _{OUT} ≤ 0		1.3	2.5		
OUT Short-Circuit Current	I _{SC}	Short to GND		110		mA	
		Short to IN		25			
Long-Term Stability	$\frac{\Delta V_{OUT}}{\text{time}}$	1000hr at +25°C		115		ppm/1000hr	
Output Voltage Hysteresis (Note 3)	$\frac{\Delta V_{OUT}}{\text{cycle}}$			125		ppm	
DYNAMIC CHARACTERISTICS							
Noise Voltage	e _{OUT}	f = 0.1Hz to 10Hz		20		μVp-p	
		f = 10Hz to 10kHz		15		μV _{RMS}	
Ripple Rejection	V _{OUT} /V _{IN}	V _{IN} = +5V ±100mV, f = 120Hz		80		dB	
Turn-On Settling Time	t _R	V _{OUT} to 0.1% of final value, C _{OUT} = 50pF		50		μs	
INPUT CHARACTERISTICS							
Supply Voltage Range	V _{IN}	Guaranteed by line-regulation test	2.5		12.6	V	
Quiescent Supply Current	I _{IN}			125	150	μA	
Change in Supply Current	$\Delta I_{IN}/\Delta V_{IN}$	2.5V ≤ V _{IN} ≤ 12.6V		3.2	8.0	μA/V	

Electrical Characteristics—MAX6168 ($V_{OUT} = 1.800V$)(V_{IN} = +5V, I_{OUT} = 0, T_A = T_{MIN} to T_{MAX}, unless otherwise specified. Typical values are at T_A = +25°C.) (Note 1)

PARAMETER	SYMBOL	CONDITIONS	MIN	TYP	MAX	UNITS	
Output Voltage	V _{OUT}	T _A = +25°C	MAX6168A	1.798	1.800	1.802	V
			MAX6168B	1.795	1.800	1.805	
Output Voltage Temperature Coefficient (Note 2)	TCV _{OUT}	MAX6168A		2	5	ppm/°C	
		MAX6168B		4	10		
Line Regulation	$\frac{\Delta V_{OUT}}{\Delta V_{IN}}$	2.5V ≤ V _{IN} ≤ 12.6V		42	200	μV/V	
Load Regulation	$\frac{\Delta V_{OUT}}{\Delta I_{OUT}}$	Sourcing: 0 ≤ I _{OUT} ≤ 5mA		0.5	0.9	mV/mA	
		Sinking: -2mA ≤ I _{OUT} ≤ 0		1.5	4		
OUT Short-Circuit Current	I _{SC}	Short to GND		110		mA	
		Short to IN		25			
Long-Term Stability	$\frac{\Delta V_{OUT}}{\text{time}}$	1000hr at +25°C		80		ppm/1000hr	
Output Voltage Hysteresis (Note 3)	$\frac{\Delta V_{OUT}}{\text{cycle}}$			125		ppm	
DYNAMIC CHARACTERISTICS							
Noise Voltage	e _{OUT}	f = 0.1Hz to 10Hz		22		μVp-p	
		f = 10Hz to 10kHz		25		μV _{RMS}	
Ripple Rejection	$\Delta V_{OUT}/\Delta V_{IN}$	V _{IN} = +5V ±100mV, f = 120Hz		78		dB	
Turn-On Settling Time	t _R	V _{OUT} to 0.1% of final value, C _{OUT} = 50pF		100		μs	
INPUT CHARACTERISTICS							
Supply Voltage Range	V _{IN}	Guaranteed by line-regulation test	2.5		12.6	V	
Quiescent Supply Current	I _{IN}			100	120	μA	
Change in Supply Current	$\Delta I_{IN}/\Delta V_{IN}$	2.5V ≤ V _{IN} ≤ 12.6V		3.4	8.0	μA/V	

Electrical Characteristics—MAX6162 (V_{OUT} = 2.048V)(V_{IN} = +5V, I_{OUT} = 0, T_A = T_{MIN} to T_{MAX}, unless otherwise specified. Typical values are at T_A = +25°C.) (Note 1)

PARAMETER	SYMBOL	CONDITIONS		MIN	TYP	MAX	UNITS
Output Voltage	V _{OUT}	T _A = +25°C	MAX6162A	2.046	2.048	2.050	V
			MAX6162B	2.043	2.048	2.053	
Output Voltage Temperature Coefficient (Note 2)	TCV _{OUT}	MAX6162A			2	5	ppm/°C
		MAX6162B			4	10	
Line Regulation	$\frac{\Delta V_{OUT}}{\Delta V_{IN}}$	2.5V ≤ V _{IN} ≤ 12.6V			42	250	μV/V
Load Regulation	$\frac{\Delta V_{OUT}}{\Delta I_{OUT}}$	Sourcing: 0 ≤ I _{OUT} ≤ 5mA			0.5	0.9	mV/mA
		Sinking: -2mA ≤ I _{OUT} ≤ 0			1.5	4	
OUT Short-Circuit Current	I _{SC}	Short to GND			110		mA
		Short to IN			25		
Long-Term Stability	$\frac{\Delta V_{OUT}}{\text{time}}$	1000hr at +25°C			80		ppm/1000hr
Output Voltage Hysteresis (Note 3)	$\frac{\Delta V_{OUT}}{\text{cycle}}$				125		ppm
DYNAMIC CHARACTERISTICS							
Noise Voltage	e _{OUT}	f = 0.1Hz to 10Hz			22		μVp-p
		f = 10Hz to 10kHz			25		μV _{RMS}
Ripple Rejection	V _{OUT} /V _{IN}	V _{IN} = 5V ±100mV, f = 120Hz			78		dB
Turn-On Settling Time	t _R	V _{OUT} to 0.1% of final value, C _{OUT} = 50pF			100		μs
INPUT CHARACTERISTICS							
Supply Voltage Range	V _{IN}	Guaranteed by line-regulation test		2.5		12.6	V
Quiescent Supply Current	I _{IN}				100	120	μA
Change in Supply Current	$\Delta I_{IN}/\Delta V_{IN}$	2.5V ≤ V _{IN} ≤ 12.6V			3.4	8.0	μA/V

Electrical Characteristics—MAX6166 ($V_{OUT} = 2.500V$)(V_{IN} = +5V, I_{OUT} = 0, T_A = T_{MIN} to T_{MAX}, unless otherwise specified. Typical values are at T_A = +25°C.) (Note 1)

PARAMETER	SYMBOL	CONDITIONS	MIN	TYP	MAX	UNITS	
Output Voltage	V _{OUT}	T _A = +25°C	MAX6166A	2.498	2.500	2.502	V
			MAX6166B	2.495	2.500	2.505	
Output Voltage Temperature Coefficient (Note 2)	TCV _{OUT}	MAX6166A		2	5	ppm/°C	
		MAX6166B		4	10		
Dropout Voltage (Note 4)	V _{IN} - V _{OUT}	I _{OUT} = 1mA		50	200	mV	
Line Regulation	$\frac{\Delta V_{OUT}}{\Delta V_{IN}}$	V _{OUT} + 0.2V ≤ V _{IN} ≤ 12.6V		60	250	μV/V	
Load Regulation	$\frac{\Delta V_{OUT}}{\Delta I_{OUT}}$	Sourcing: 0 ≤ I _{OUT} ≤ 5mA		0.5	0.9	mV/mA	
		Sinking: -2mA ≤ I _{OUT} ≤ 0		1.6	5		
OUT Short-Circuit Current	I _{SC}	Short to GND		110		mA	
		Short to IN		25			
Long-Term Stability	$\frac{\Delta V_{OUT}}{\text{time}}$	1000hr at +25°C		80		ppm/1000hr	
Output Voltage Hysteresis (Note 3)	$\frac{\Delta V_{OUT}}{\text{cycle}}$			125		ppm	
DYNAMIC CHARACTERISTICS							
Noise Voltage	e _{OUT}	f = 0.1Hz to 10Hz		27		μVp-p	
		f = 10Hz to 10kHz		30		μV _{RMS}	
Ripple Rejection	V _{OUT} /V _{IN}	V _{IN} = 5V ±100mV, f = 120Hz		76		dB	
Turn-On Settling Time	t _R	V _{OUT} to 0.1% of final value, C _{OUT} = 50pF		115		μs	
INPUT CHARACTERISTICS							
Supply Voltage Range	V _{IN}	Guaranteed by line-regulation test		V _{OUT} + 0.2	12.6	V	
Quiescent Supply Current	I _{IN}			100	120	μA	
Change in Supply Current	$\Delta I_{IN}/\Delta V_{IN}$	V _{OUT} + 0.2V ≤ V _{IN} ≤ 12.6V		3.2	8.0	μA/V	

Electrical Characteristics—MAX6163 ($V_{OUT} = 3.000V$)(V_{IN} = +5V, I_{OUT} = 0, T_A = T_{MIN} to T_{MAX}, unless otherwise specified. Typical values are at T_A = +25°C.) (Note 1)

PARAMETER	SYMBOL	CONDITIONS	MIN	TYP	MAX	UNITS	
Output Voltage	V _{OUT}	T _A = +25°C	MAX6163A	2.998	3.000	3.002	V
			MAX6163B	2.995	3.000	3.005	
Output Voltage Temperature Coefficient (Note 2)	TCV _{OUT}	MAX6163A		2	5	ppm/°C	
		MAX6163B		4	10		
Dropout Voltage (Note 4)	V _{IN} - V _{OUT}	I _{OUT} = 1mA		50	200	mV	
Line Regulation	$\frac{\Delta V_{OUT}}{\Delta V_{IN}}$	V _{OUT} + 0.2V ≤ V _{IN} ≤ 12.6V		83	300	μV/V	
Load Regulation	$\frac{\Delta V_{OUT}}{\Delta I_{OUT}}$	Sourcing: 0 ≤ I _{OUT} ≤ 5mA		0.5	0.9	mV/mA	
		Sinking: -2mA ≤ I _{OUT} ≤ 0		1.8	5		
OUT Short-Circuit Current	I _{SC}	Short to GND		110		mA	
		Short to IN		25			
Long-Term Stability	$\frac{\Delta V_{OUT}}{\text{time}}$	1000hr at +25°C		80		ppm/1000hr	
Output Voltage Hysteresis (Note 3)	$\frac{\Delta V_{OUT}}{\text{cycle}}$			125		ppm	
DYNAMIC CHARACTERISTICS							
Noise Voltage	e _{OUT}	f = 0.1Hz to 10Hz		35		μVp-p	
		f = 10Hz to 10kHz		40		μV _{RMS}	
Ripple Rejection	V _{OUT} /V _{IN}	V _{IN} = 5V ±100mV, f = 120Hz		76		dB	
Turn-On Settling Time	t _R	V _{OUT} to 0.1% of final value, C _{OUT} = 50pF		115		μs	
INPUT CHARACTERISTICS							
Supply Voltage Range	V _{IN}	Guaranteed by line-regulation test		V _{OUT} + 0.2	12.6	V	
Quiescent Supply Current	I _{IN}			100	120	μA	
Change in Supply Current	$\Delta I_{IN}/\Delta V_{IN}$	V _{OUT} + 0.2V ≤ V _{IN} ≤ 12.6V		3.2	8.0	μA/V	

Electrical Characteristics—MAX6164 ($V_{OUT} = 4.096V$)(V_{IN} = +5V, I_{OUT} = 0, T_A = T_{MIN} to T_{MAX}, unless otherwise specified. Typical values are at T_A = +25°C.) (Note 1)

PARAMETER	SYMBOL	CONDITIONS	MIN	TYP	MAX	UNITS	
Output Voltage	V _{OUT}	T _A = +25°C	MAX6164A	4.094	4.096	4.098	V
			MAX6164B	4.091	4.096	4.101	
Output Voltage Temperature Coefficient (Note 2)	TCV _{OUT}	MAX6164A		2	5	ppm/°C	
		MAX6164B		4	10		
Dropout Voltage (Note 4)	V _{IN} - V _{OUT}	I _{OUT} = 1mA		50	200	mV	
Line Regulation	$\frac{\Delta V_{OUT}}{\Delta V_{IN}}$	V _{OUT} + 0.2V ≤ V _{IN} ≤ 12.6V		140	300	μV/V	
Load Regulation	$\frac{\Delta V_{OUT}}{\Delta I_{OUT}}$	Sourcing: 0 ≤ I _{OUT} ≤ 5mA		0.6	0.9	mV/mA	
		Sinking: -2mA ≤ I _{OUT} ≤ 0		2.0	7.0		
OUT Short-Circuit Current	I _{SC}	Short to GND		110		mA	
		Short to IN		25			
Long-Term Stability	$\frac{\Delta V_{OUT}}{\text{time}}$	1000hr at +25°C		80		ppm/1000hr	
Output Voltage Hysteresis (Note 3)	$\frac{\Delta V_{OUT}}{\text{cycle}}$			125		ppm	
DYNAMIC CHARACTERISTICS							
Noise Voltage	e _{OUT}	f = 0.1Hz to 10Hz		50		μVp-p	
		f = 10Hz to 10kHz		50		μV _{RMS}	
Ripple Rejection	V _{OUT} /V _{IN}	V _{IN} = 5V ±100mV, f = 120Hz		72		dB	
Turn-On Settling Time	t _R	V _{OUT} to 0.1% of final value, C _{OUT} = 50pF		190		μs	
INPUT CHARACTERISTICS							
Supply Voltage Range	V _{IN}	Guaranteed by line-regulation test		V _{OUT} + 0.2	12.6	V	
Quiescent Supply Current	I _{IN}			100	120	μA	
Change in Supply Current	$\Delta I_{IN}/\Delta V_{IN}$	V _{OUT} + 0.2V ≤ V _{IN} ≤ 12.6V		3.2	8.0	μA/V	

Electrical Characteristics—MAX6167 ($V_{OUT} = 4.500V$)(V_{IN} = +5V, I_{OUT} = 0, T_A = T_{MIN} to T_{MAX}, unless otherwise specified. Typical values are at T_A = +25°C.) (Note 1)

PARAMETER	SYMBOL	CONDITIONS	MIN	TYP	MAX	UNITS	
Output Voltage	V _{OUT}	T _A = +25°C	MAX6167A	4.498	4.500	4.502	V
			MAX6167B	4.495	4.500	4.505	
Output Voltage Temperature Coefficient (Note 2)	TCV _{OUT}	MAX6167A		2	5	ppm/°C	
		MAX6167B		4	10		
Dropout Voltage (Note 4)	V _{IN} - V _{OUT}	I _{OUT} = 1mA		50	200	mV	
Line Regulation	$\frac{\Delta V_{OUT}}{\Delta V_{IN}}$	V _{OUT} + 0.2V ≤ V _{IN} ≤ 12.6V		160	450	μV/V	
Load Regulation	$\frac{\Delta V_{OUT}}{\Delta I_{OUT}}$	Sourcing: 0 ≤ I _{OUT} ≤ 5mA		0.6	0.9	mV/mA	
		Sinking: -2mA ≤ I _{OUT} ≤ 0		2.3	8.0		
OUT Short-Circuit Current	I _{SC}	Short to GND		110		mA	
		Short to IN		25			
Long-Term Stability	$\frac{\Delta V_{OUT}}{\text{time}}$	1000hr at +25°C		80		ppm/1000hr	
Output Voltage Hysteresis (Note 3)	$\frac{\Delta V_{OUT}}{\text{cycle}}$			125		ppm	
DYNAMIC CHARACTERISTICS							
Noise Voltage	e _{OUT}	f = 0.1Hz to 10Hz		55		μVp-p	
		f = 10Hz to 10kHz		55		μV _{RMS}	
Ripple Rejection	V _{OUT} /V _{IN}	V _{IN} = 5V ±100mV, f = 120Hz		70		dB	
Turn-On Settling Time	t _R	V _{OUT} to 0.1% of final value, C _{OUT} = 50pF		230		μs	
INPUT CHARACTERISTICS							
Supply Voltage Range	V _{IN}	Guaranteed by line-regulation test		V _{OUT} + 0.2	12.6	V	
Quiescent Supply Current	I _{IN}			100	120	μA	
Change in Supply Current	$\Delta I_{IN}/\Delta V_{IN}$	V _{OUT} + 0.2V ≤ V _{IN} ≤ 12.6V		3.1	8.0	μA/V	

Electrical Characteristics—MAX6165 ($V_{OUT} = 5.000V$)(V_{IN} = +5V, I_{OUT} = 0, T_A = T_{MIN} to T_{MAX}, unless otherwise specified. Typical values are at T_A = +25°C.) (Note 1)

PARAMETER	SYMBOL	CONDITIONS	MIN	TYP	MAX	UNITS	
Output Voltage	V _{OUT}	T _A = +25°C	MAX6165A	4.998	5.000	5.002	V
			MAX6165B	4.995	5.000	5.005	
Output Voltage Temperature Coefficient (Note 2)	TCV _{OUT}	MAX6165A		2	5	ppm/°C	
		MAX6165B		4	10		
Dropout Voltage (Note 4)	V _{IN} - V _{OUT}	I _{OUT} = 1mA		50	200	mV	
Line Regulation	$\frac{\Delta V_{OUT}}{\Delta V_{IN}}$	V _{OUT} + 0.2V ≤ V _{IN} ≤ 12.6V		180	400	μV/V	
Load Regulation	$\frac{\Delta V_{OUT}}{\Delta I_{OUT}}$	Sourcing: 0 ≤ I _{OUT} ≤ 5mA		0.6	0.9	mV/mA	
		Sinking: -2mA ≤ I _{OUT} ≤ 0		2.4	8.0		
OUT Short-Circuit Current	I _{SC}	Short to GND		110		mA	
		Short to IN		25			
Long-Term Stability	$\frac{\Delta V_{OUT}}{\text{time}}$	1000hr at +25°C		80		ppm/1000hr	
Output Voltage Hysteresis (Note 3)	$\frac{\Delta V_{OUT}}{\text{cycle}}$			125		ppm	
DYNAMIC CHARACTERISTICS							
Noise Voltage	e _{OUT}	f = 0.1Hz to 10Hz		60		μVp-p	
		f = 10Hz to 10kHz		60		μV _{RMS}	
Ripple Rejection	V _{OUT} /V _{IN}	V _{IN} = 5.5V ±100mV, f = 120Hz		65		dB	
Turn-On Settling Time	t _R	V _{OUT} to 0.1% of final value, C _{OUT} = 50pF		300		μs	
INPUT CHARACTERISTICS							
Supply Voltage Range	V _{IN}	Guaranteed by line-regulation test		V _{OUT} + 0.2	12.6	V	
Quiescent Supply Current	I _{IN}			100	120	μA	
Change in Supply Current	ΔI _{IN} /ΔV _{IN}	V _{OUT} + 0.2V ≤ V _{IN} ≤ 12.6V		3.1	8.0	μA/V	

Note 1: 100% production tested at T_A = +25°C. Guaranteed by design for T_A = -40°C to +85°C.**Note 2:** Temperature Coefficient is specified by the "box" method; i.e., the maximum ΔV_{OUT} is divided by the maximum ΔT.**Note 3:** Thermal Hysteresis is defined as the change in T_A = +25°C output voltage before and after temperature cycling of the device (from T_A = T_{MIN} to T_{MAX}). Initial measurement at T_A = +25°C is followed by temperature cycling the device to T_A = +85°C then to T_A = -40°C, and another measurement at T_A = +25°C is compared to the original measurement at T_A = +25°C.**Note 4:** Dropout voltage is the minimum input voltage at which V_{OUT} changes ≤ 0.2% from V_{OUT} at V_{IN} = 5.0V (V_{IN} = 5.5V for MAX6165).

Typical Operating Characteristics

($V_{IN} = +5V$ for MAX6161–MAX6168, $V_{IN} = +5.5V$ for MAX6165, $I_{OUT} = 0$, $T_A = +25^\circ C$, unless otherwise noted.) (Note 5)

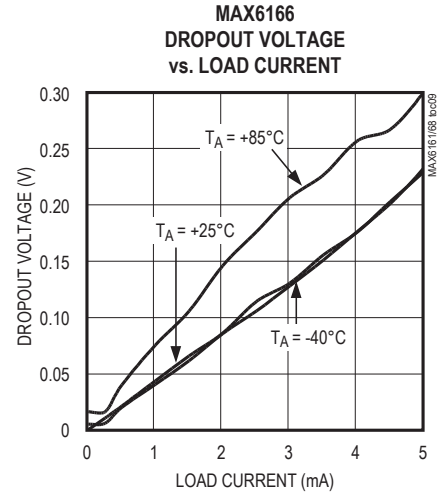
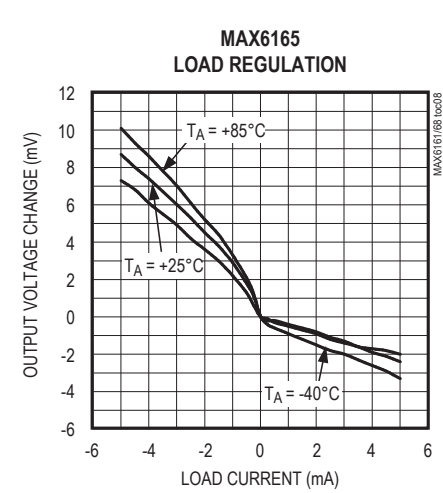
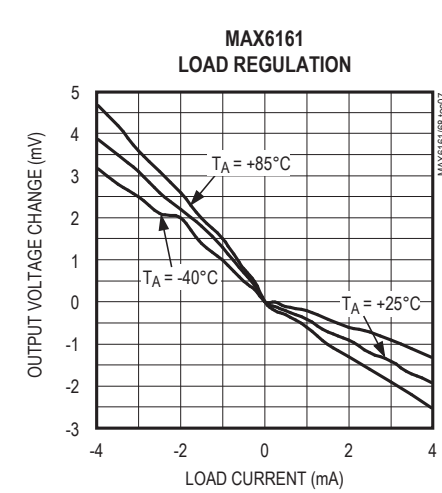
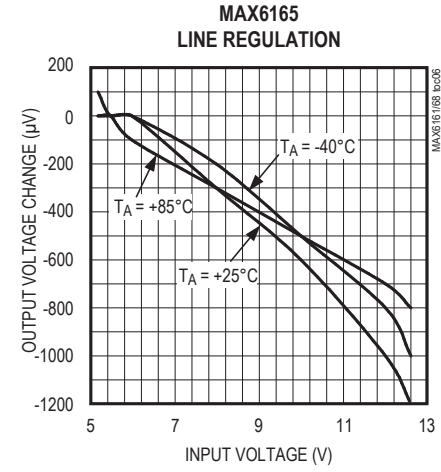
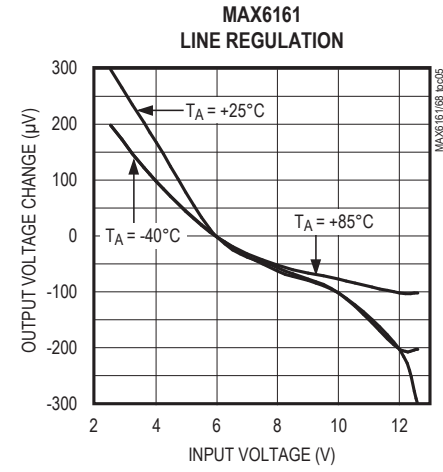
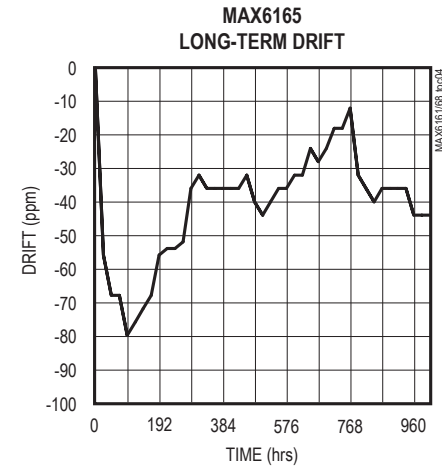
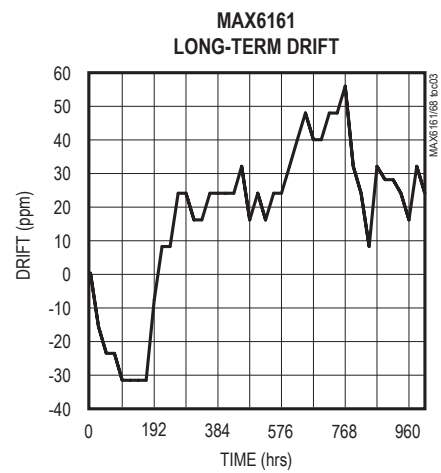
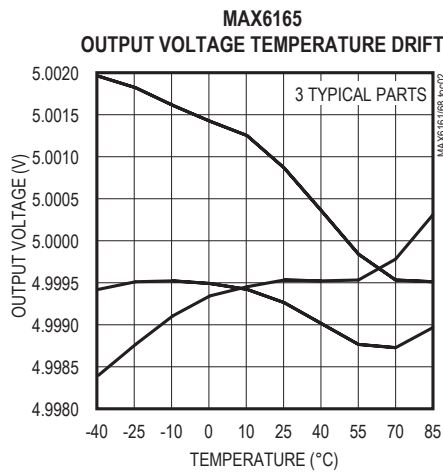
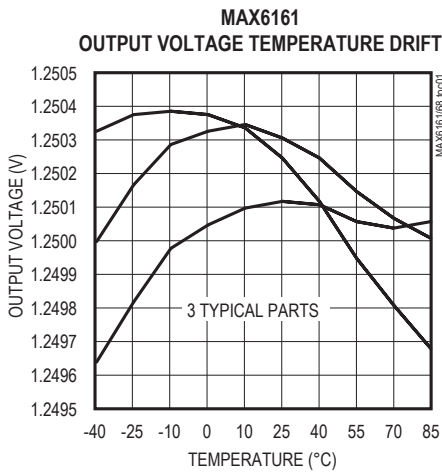

Typical Operating Characteristics (continued)

($V_{IN} = +5V$ for MAX6161–MAX6168, $V_{IN} = +5.5V$ for MAX6165, $I_{OUT} = 0$, $T_A = +25^\circ C$, unless otherwise noted.) (Note 5)

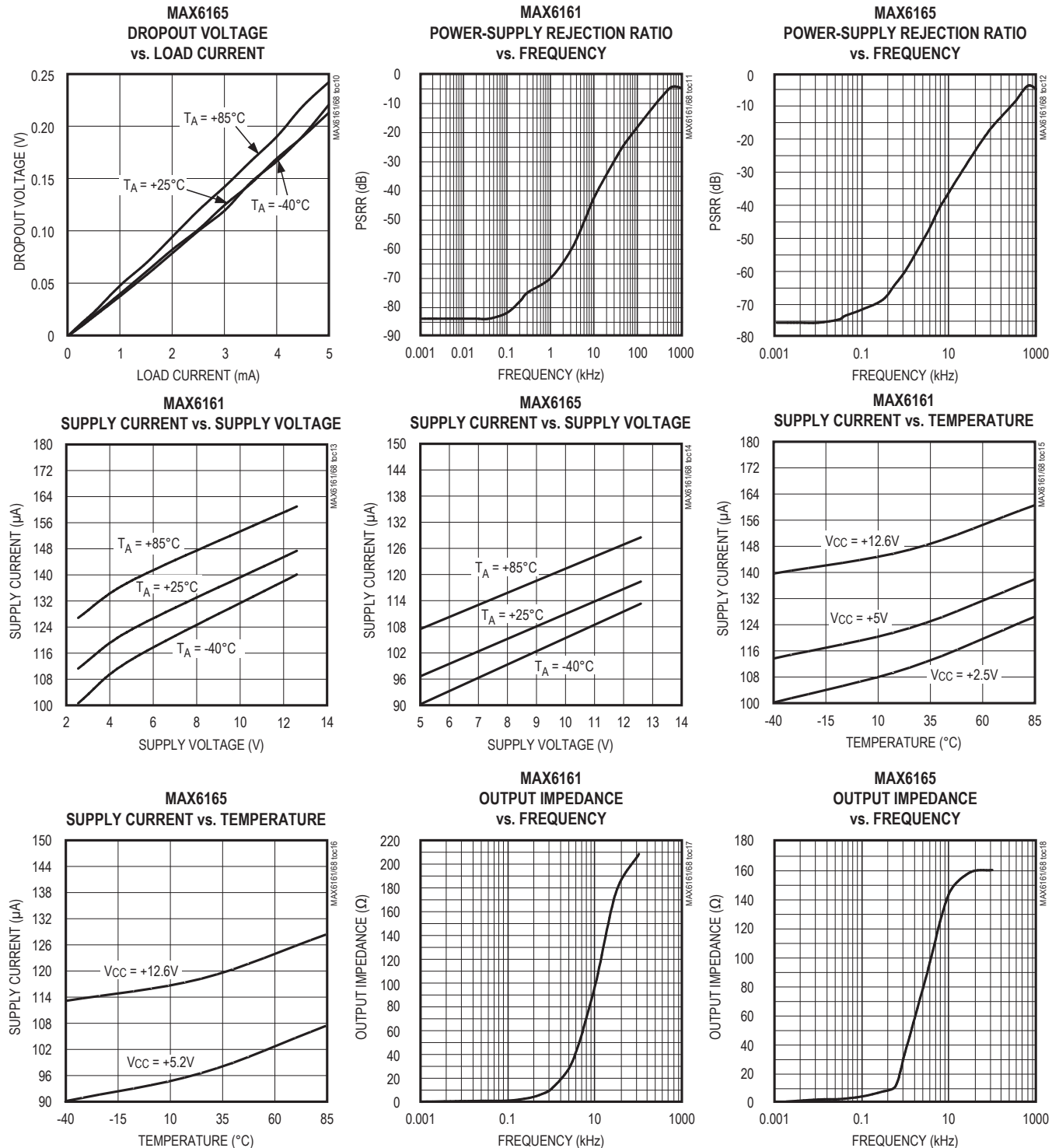

Typical Operating Characteristics (continued)

($V_{IN} = +5V$ for MAX6161–MAX6168, $V_{IN} = +5.5V$ for MAX6165, $I_{OUT} = 0$, $T_A = +25^{\circ}C$, unless otherwise noted.) (Note 5)

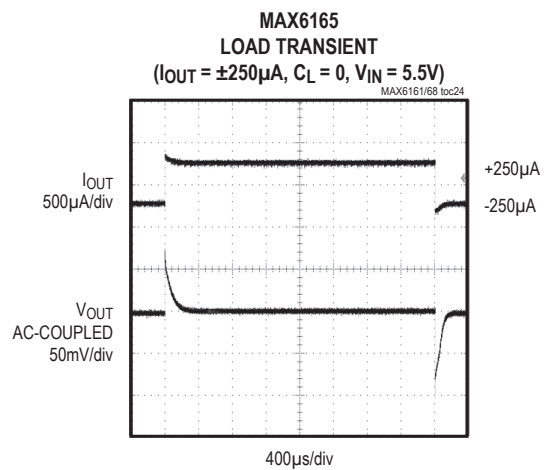
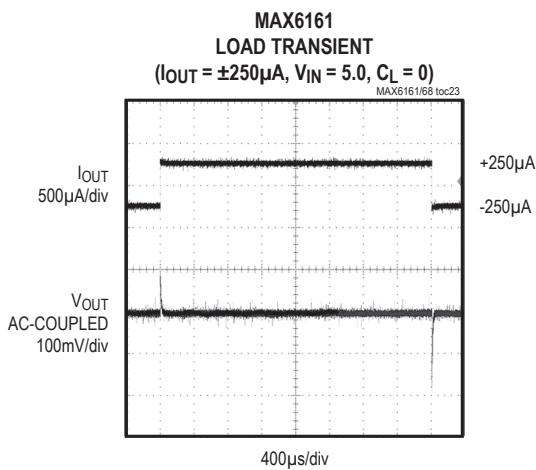
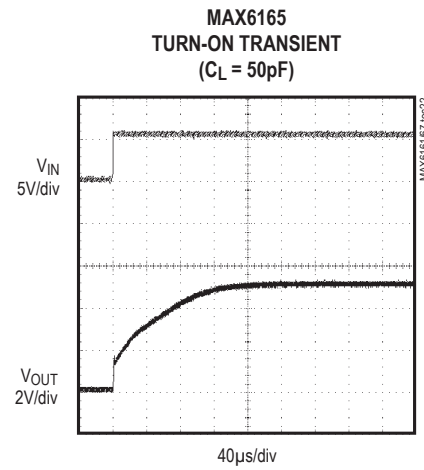
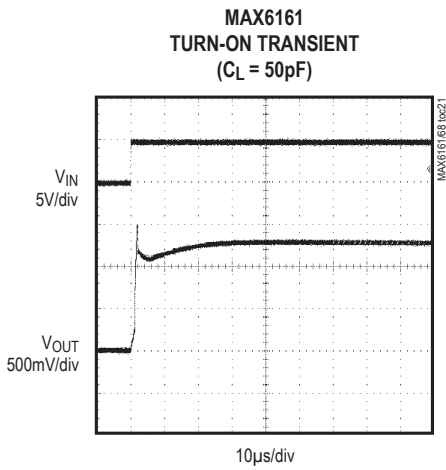
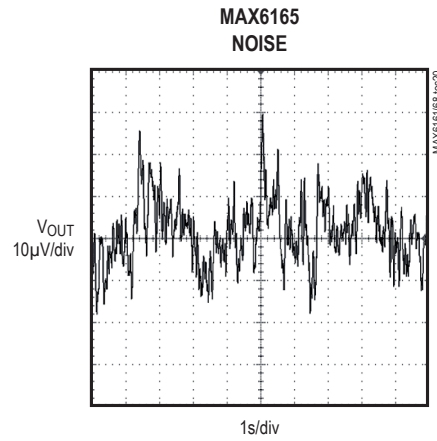
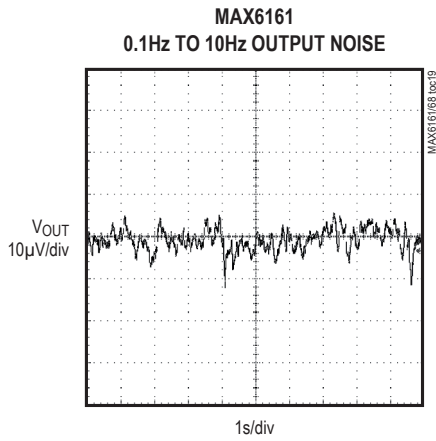

Typical Operating Characteristics (continued)

($V_{IN} = +5V$ for MAX6161–MAX6168, $V_{IN} = +5.5V$ for MAX6165, $I_{OUT} = 0$, $T_A = +25^\circ C$, unless otherwise noted.) (Note 5)

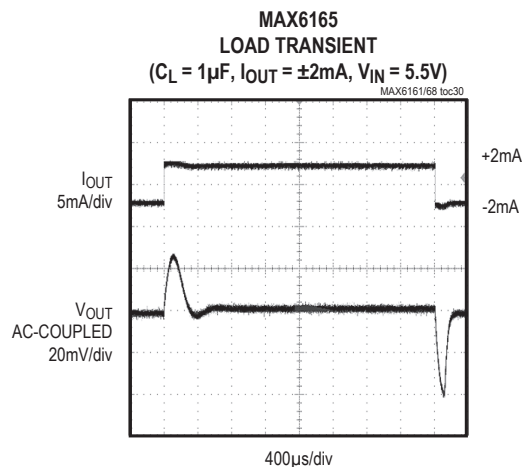
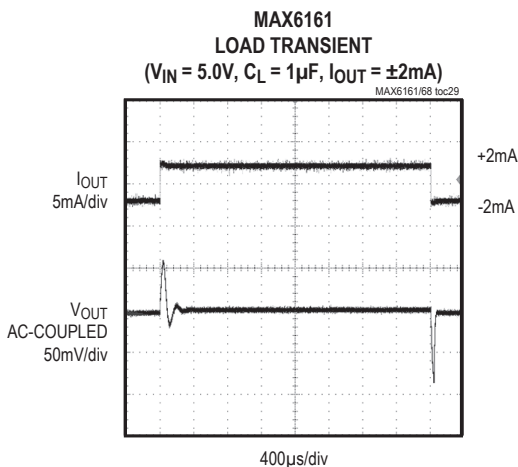
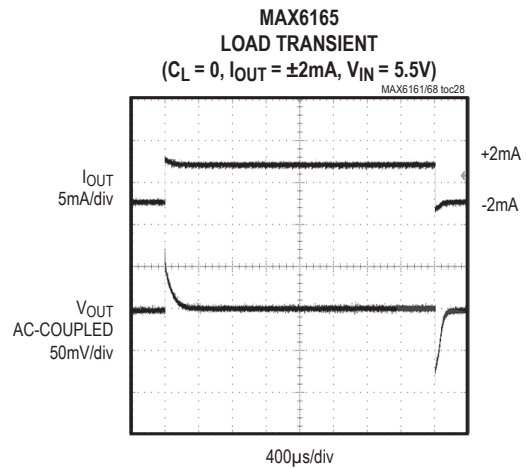
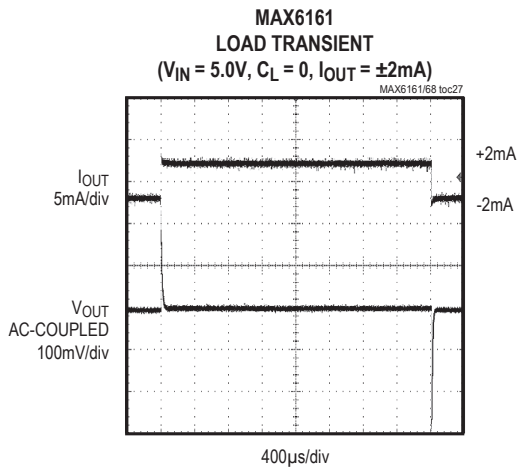
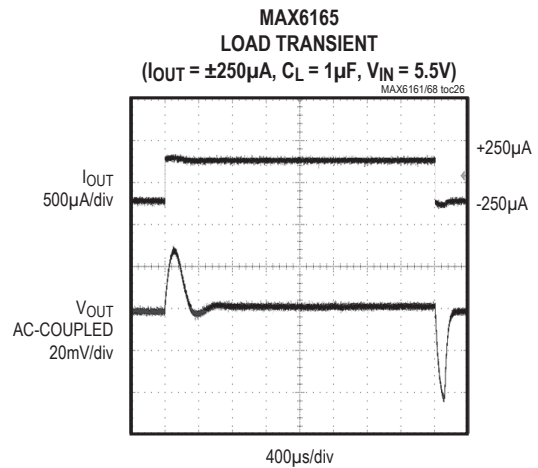
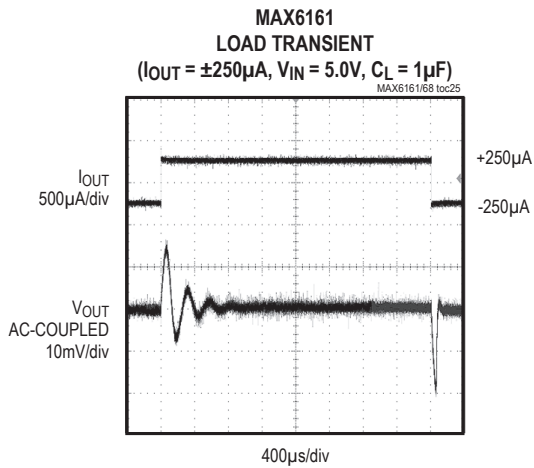

Typical Operating Characteristics (continued)

($V_{IN} = +5V$ for MAX6161–MAX6168, $V_{IN} = +5.5V$ for MAX6165, $I_{OUT} = 0$, $T_A = +25^{\circ}C$, unless otherwise noted.) (Note 5)

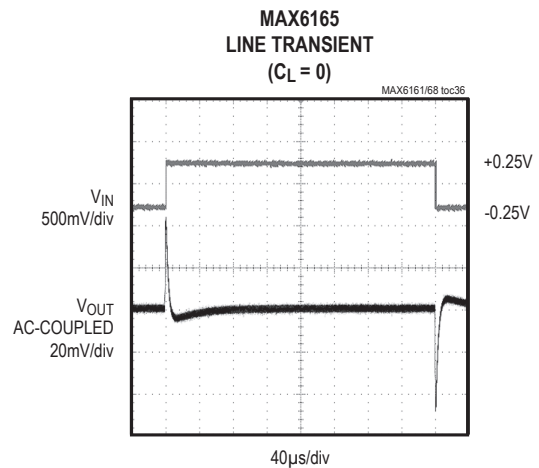
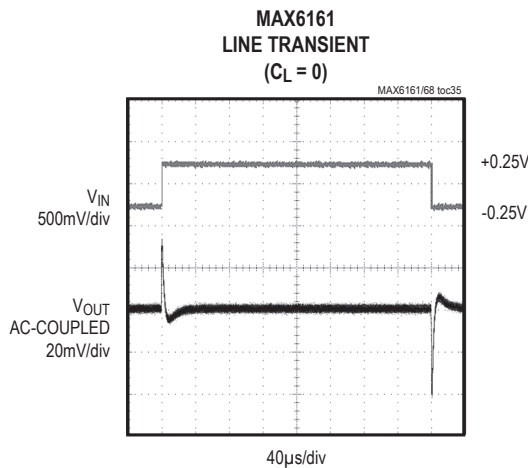
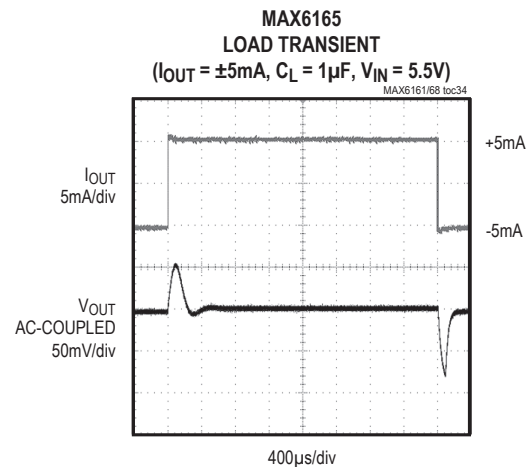
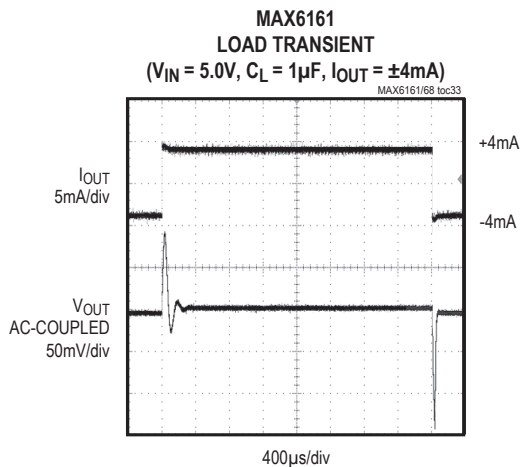
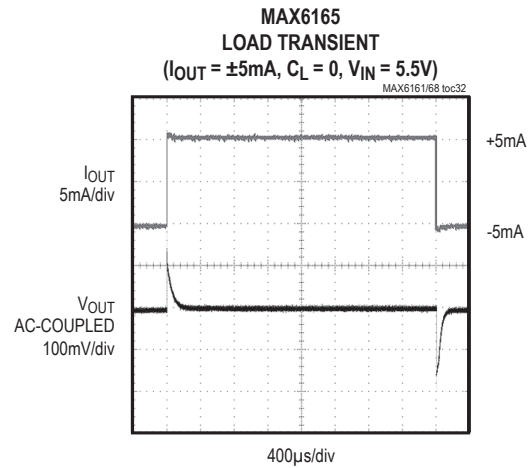
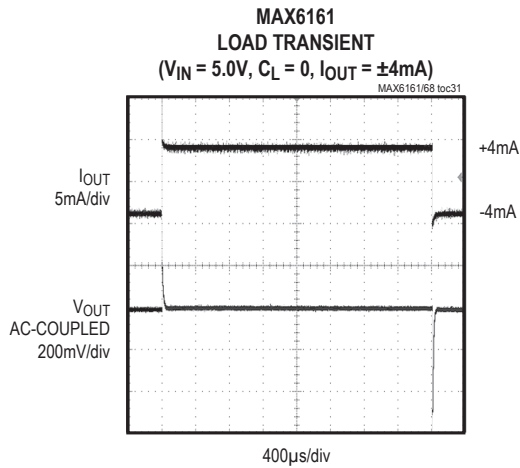

Note 5: Many of the *Typical Operating Characteristics* of the MAX6161 family are extremely similar. The extremes of these characteristics are found in the MAX6161 (1.25V output) and the MAX6165 (5.0V output). The *Typical Operating Characteristics* of the remainder of the MAX6161 family typically lie between these two extremes and can be estimated based on their output voltages.

Pin Description

PIN	NAME	FUNCTION
1, 3, 5, 7, 8	N.C.	No Connection. Not internally connected.
2	IN	Input Voltage
4	GND	Ground
6	OUT	Reference Output

Applications Information

Input Bypassing

For the best line-transient performance, decouple the input with a 0.1 μ F ceramic capacitor as shown in the *Typical Operating Circuit*. Locate the capacitor as close to IN as possible. When transient performance is less important, no capacitor is necessary.

Output/Load Capacitance

Devices in the MAX6161 family do not require an output capacitor for frequency stability. In applications where the load or the supply can experience step changes, an output capacitor of at least 0.1 μ F will reduce the amount of overshoot (undershoot) and improve the circuit's transient response. Many applications do not require an external capacitor, and the MAX6161 family can offer a significant advantage in applications when board space is critical.

Supply Current

The quiescent supply current of the series-mode MAX6161 family is typically 100 μ A and is virtually independent of the supply voltage, with only an 8 μ A/V (max) variation with supply voltage. Unlike series references, shunt-mode references operate with a series resistor connected to the power supply. The quiescent current of a shunt-mode reference is thus a function of the input voltage. Additionally, shunt-mode references have to be biased at the maximum expected load current, even if the load current is not present at the time. In the MAX6161 family, the load current is drawn from the input voltage only when required, so supply current is not wasted and efficiency is maximized at all input voltages. This improved efficiency reduces power dissipation and extends battery life.

When the supply voltage is below the minimum specified input voltage (as during turn-on), the devices can draw up to 400 μ A beyond the nominal supply current. The input voltage source must be capable of providing this current to ensure reliable turn-on.

Output Voltage Hysteresis

Output voltage hysteresis is the change in the input voltage at $T_A = +25^\circ\text{C}$ before and after the device is cycled over its entire operating temperature range. Hysteresis is caused by differential package stress appearing across the bandgap core transistors. The typical temperature hysteresis value is 125ppm.

Turn-On Time

These devices typically turn on and settle to within 0.1% of their final value in 50 μ s to 300 μ s, depending on the output voltage (see electrical table of part used). The turn-on time can increase up to 1.5ms with the device operating at the minimum dropout voltage and the maximum load.

Typical Operating Circuit

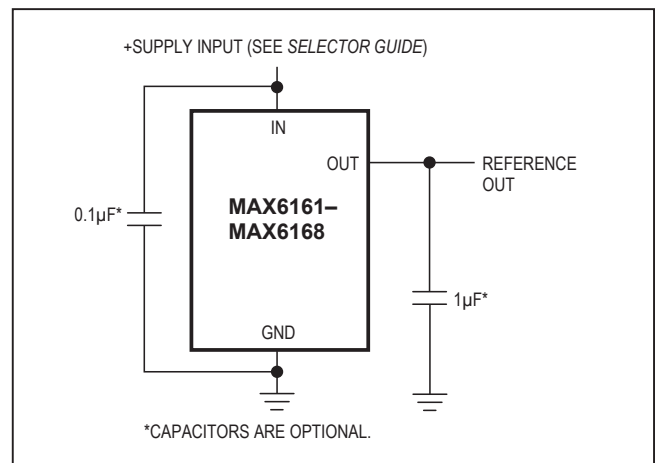

Chip Information

TRANSISTOR COUNT: 117

PROCESS: BiCMOS

Selector Guide

PART	OUTPUT VOLTAGE (V)	INITIAL ACCURACY (mV)	TEMPERATURE COEFFICIENT (ppm/°C)
MAX6161A	1.250	±2	10
MAX6161B	1.250	±4	15
MAX6168A	1.800	±2	5
MAX6168B	1.800	±5	10
MAX6162A	2.048	±2	5
MAX6162B	2.048	±5	10
MAX6166A	2.500	±2	5
MAX6166B	2.500	±5	10
MAX6163A	3.000	±2	5
MAX6163B	3.000	±5	10
MAX6164A	4.096	±2	5
MAX6164B	4.096	±5	10
MAX6167A	4.500	±2	5
MAX6167B	4.500	±5	10
MAX6165A	5.000	±2	5
MAX6165B	5.000	±5	10

Ordering Information

PART*	TEMP RANGE	PIN-PACKAGE	OUTPUT VOLTAGE (V)
MAX6161_ESA+	-40°C to +85°C	8 SO	1.250
MAX6162_ESA+	-40°C to +85°C	8 SO	2.048
MAX6163_ESA+	-40°C to +85°C	8 SO	3.000
MAX6164_ESA+	-40°C to +85°C	8 SO	4.096
MAX6165_ESA+	-40°C to +85°C	8 SO	5.000
MAX6166_ESA+	-40°C to +85°C	8 SO	2.500
MAX6167_ESA+	-40°C to +85°C	8 SO	4.500
MAX6168_ESA+	-40°C to +85°C	8 SO	1.800

+Denotes a lead(Pb)-free package/RoHS-compliant package.

*Insert the code for the desired initial accuracy and temperature coefficient (from the Selector Guide) in the blank to complete the part number.

Note: For leaded version, contact factory.

Package Information

For the latest package outline information and land patterns (footprints), go to www.maximintegrated.com/packages. Note that a "+", "#", or "-" in the package code indicates RoHS status only. Package drawings may show a different suffix character, but the drawing pertains to the package regardless of RoHS status.

PACKAGE TYPE	PACKAGE CODE	OUTLINE NO.	LAND PATTERN NO.
8 SO	S8+2	21-0041	90-0096