

EVALUATION KIT
AVAILABLE

300mA LDO Linear Regulators with Internal Microprocessor Reset Circuit

General Description

The MAX6469–MAX6484 are low-dropout linear regulators with a fully integrated microprocessor reset circuit. Each is available with preset output voltages from +1.5V to +3.3V in 100mV increments and delivers up to 300mA of load current. These devices consume only 82 μ A of supply current. The low supply current, low dropout voltage, and integrated reset functionality make these devices ideal for battery-powered portable equipment.

The MAX6469–MAX6484 include a reset output that indicates when the regulator output drops below standard microprocessor supply tolerances (-7.5% or -12.5% of nominal output voltage). This eliminates the need for an external microprocessor supervisor, while ensuring that supply voltages and clock oscillators have stabilized before processor activity is enabled. Push-pull and open-drain active-low reset outputs are available, with reset timeout periods of 2.5ms, 20ms, 150ms, or 1200ms (min).

The MAX6469/MAX6470/MAX6473–MAX6478/MAX6481–MAX6484 also have a shutdown feature that reduces the supply current to 0.1 μ A (typ). The MAX6471–MAX6474/MAX6479–MAX6482 offer a manual reset input to assert a microprocessor reset while the regulator output is within specification. The MAX6475/MAX6476/MAX6483/MAX6484 feature a remote feedback sense pin for use with an external NPN transistor for higher-current applications. The MAX6469–MAX6476 are available in 6-pin SOT23 and 8-pin TDFN packages. The MAX6477–MAX6484 are available in a 3 \times 3 chip-scale package (UCSP™). All devices are specified for operation from -40°C to +85°C.

Applications

Handheld Instruments (PDAs, Palmtops)
PCMCIA Cards/USB Devices
Cellular/Cordless Telephones
CD/DVD Drives
Notebook Computers
Digital Cameras
Bluetooth Modules/Wireless LAN

UCSP is a trademark of Maxim Integrated Products, Inc.

Pin Configurations appear at end of data sheet.

Typical Operating Circuits appear at end of data sheet.

Features

- ◆ 3 \times 3 UCSP, 6-Pin SOT23, and 8-Pin TDFN Packages
- ◆ Preset +1.5V to +3.3V Output (100mV Increments)
- ◆ SET Pin for Adjustable Output Voltage
- ◆ 75 μ V_{RMS} LDO Output Voltage Noise (MAX6477–MAX6484)
- ◆ \pm 2.0% Accuracy Over Temperature
- ◆ Guaranteed 300mA Output Current
- ◆ Low Dropout Voltage
55mV at 150mA
114mV at 300mA
- ◆ 82 μ A Supply Current, 0.1 μ A Shutdown Current
- ◆ Input Reverse Current, Thermal and Short-Circuit Protection
- ◆ Microprocessor Reset with Four Timeout Options
- ◆ Push-Pull or Open-Drain RESET
- ◆ Manual Reset Input
- ◆ Remote Feedback Sense

Ordering Information

PART*	TEMP RANGE	PIN-PACKAGE
MAX6469UT__D_-T	-40°C to +85°C	6 SOT23-6
MAX6469TA__D_-T**	-40°C to +85°C	8 TDFN-EP***
MAX6470UT__D_-T	-40°C to +85°C	6 SOT23-6
MAX6470TA__D_-T**	-40°C to +85°C	8 TDFN-EP***

Ordering Information continued at end of data sheet.

*Devices are also available in a lead(Pb)-free/RoHS-compliant packages. Specify lead(Pb)-free by substituting a +T instead of a -T when ordering.

**Future product—contact factory for availability.

***EP = Exposed pad.

Note: The first “_” are placeholders for the output voltage levels of the devices. Desired output voltages are set by the suffix found in the Output Voltage Suffix Guide (Table 1). The third “_” is a placeholder for the reset threshold accuracy. Desired reset threshold accuracy is set by the suffix found in the Reset Threshold Accuracy Guide (Table 2). The “_” following the D is a placeholder for the reset timeout delay time. Desired reset timeout delay time is set by the suffix found in the Reset Timeout Delay Guide (Table 3). For example, the MAX6481BL30BD4-T has a 3.0V output voltage, 12.5% reset threshold tolerance, and a 1200ms (min) reset timeout delay. Sample stock is generally available on standard versions only (Table 4). Standard versions require a minimum order increment of 2.5k units. Nonstandard versions must be ordered in 10k-unit increments. Contact factory for availability.



300mA LDO Linear Regulators with Internal Microprocessor Reset Circuit

ABSOLUTE MAXIMUM RATINGS

(All voltages referenced to GND, unless otherwise noted.)

IN, SHDN, OUT, FB	-0.3V to +7V
MR, SET	-0.3V to (V _{IN} + 0.3V)
RESET (push-pull)	-0.3V to (V _{OUT} + 0.3V)
RESET (open drain)	-0.3V to +7V
OUT Short Circuit	Continuous
Input/Output Current (all pins except IN and OUT)20mA
Continuous Power Dissipation (T _A = +70°C)	
3 x 3 UCSP (derate 10.5mW/°C above +70°C)840mW

6-Pin SOT23 (derate 9.1mW/°C above +70°C)727mW
8-Pin TDFN (derate 24.4mW/°C above +70°C)1951mW
Operating Temperature Range-40°C to +85°C
Junction Temperature+150°C
Storage Temperature Range-65°C to +150°C
Lead Temperature (soldering, 10s)+300°C
Soldering Temperature (reflow)	
Lead(Pb)-free packages+260°C
Packages containing lead(Pb)+240°C

Note 1: The MAX6477-MAX6484 are constructed using a unique set of packaging techniques that impose a limit on the thermal profile the devices can be exposed to during board-level solder attach and rework. This limit permits only the use of the solder profiles recommended in the industry-standard specification, JEDEC 020A, paragraph 7.6, Table 3 for IR/VPR and Convection reflow. Pre-heating is required. Hand or wave soldering is not allowed.

Stresses beyond those listed under "Absolute Maximum Ratings" may cause permanent damage to the device. These are stress ratings only, and functional operation of the device at these or any other conditions beyond those indicated in the operational sections of the specifications is not implied. Exposure to absolute maximum rating conditions for extended periods may affect device reliability.

ELECTRICAL CHARACTERISTICS

(V_{IN} = (V_{OUT} + 0.5V) or +2.5V, whichever is greater, C_{OUT} = 3.3μF, T_A = -40°C to +85°C. Typical specifications are at T_A = +25°C, unless otherwise noted.) (Note 2)

PARAMETER	SYMBOL	CONDITIONS	MIN	TYP	MAX	UNITS
Input Voltage Range	V _{IN}		2.5		5.5	V
Input Undervoltage Lockout	V _{UVLO}	V _{IN} falling	2.25		2.47	V
Supply Current (Ground Current)	I _Q	I _{OUT} = 0A		82	136	μA
		I _{OUT} = 300mA		96		
Shutdown Supply Current	I _{SHDN}	T _A = +25°C		0.1	1	μA
REGULATOR CIRCUIT						
Output Current			300			mA
Output Voltage Accuracy (Fixed Output Voltage Operation, Table 1) MAX6469-MAX6476		1mA ≤ I _{OUT} ≤ 150mA, T _A = +25°C	-1.3		+1.3	%
		1mA ≤ I _{OUT} ≤ 150mA, T _A = -40°C to +85°C	-2.3		+2.3	
		1mA ≤ I _{OUT} ≤ 300mA, T _A = -40°C to +85°C	-2.7		+2.7	
Output Voltage Accuracy (Fixed Output Voltage Operation, Table 1) MAX6477-MAX6484		2mA ≤ I _{OUT} ≤ 100mA, T _A = +25°C	-1.1		+1.1	%
		2mA ≤ I _{OUT} ≤ 100mA, T _A = -40°C to +85°C	-2.0		+2.0	
		2mA ≤ I _{OUT} ≤ 300mA, T _A = -40°C to +85°C (Note 3)	-2.5		+2.5	
Adjustable Output Voltage Range			V _{SET}		5.0	V
SET Reference Voltage	V _{SET}		1.200	1.229	1.258	V
SET Dual Mode™ Threshold				185		mV
SET Input Leakage Current	I _{SET}	V _{SET} = 0V, +1.2V (Note 3)		±20	±100	nA

Dual Mode is a trademark of Maxim Integrated Products, Inc.

300mA LDO Linear Regulators with Internal Microprocessor Reset Circuit

MAX6469-MAX6484

ELECTRICAL CHARACTERISTICS (continued)

($V_{IN} = (V_{OUT} + 0.5V)$ or $+2.5V$, whichever is greater, $C_{OUT} = 3.3\mu F$, $T_A = -40^\circ C$ to $+85^\circ C$. Typical specifications are at $T_A = +25^\circ C$, unless otherwise noted.) (Note 2)

PARAMETER	SYMBOL	CONDITIONS		MIN	TYP	MAX	UNITS
Dropout Voltage (Notes 3, 4)	ΔV_{DO}	$V_{OUT} = +3.3V$ (fixed output operation)	$I_{OUT} = 50mA$		23	32	mV
			$I_{OUT} = 150mA$		55	90	
			$I_{OUT} = 300mA$		114	180	
		$V_{OUT} = +3.0V$ (fixed output operation)	$I_{OUT} = 50mA$		25	40	
			$I_{OUT} = 150mA$		61	100	
			$I_{OUT} = 300mA$		114	190	
		$V_{OUT} = +2.8V$ (fixed output operation)	$I_{OUT} = 50mA$		26	50	
			$I_{OUT} = 150mA$		65	110	
			$I_{OUT} = 300mA$		137	210	
		$V_{OUT} = +2.5V$ (fixed output operation)	$I_{OUT} = 50mA$		30	60	
			$I_{OUT} = 150mA$		75	150	
			$I_{OUT} = 300mA$		158	250	
Output Current Limit		$V_{IN} \geq 2.5V$ (Note 3)	450				mA
Input Reverse Leakage Current (OUT to IN Leakage Current)		$V_{IN} = 4V$, $V_{OUT} = 5.5V$, \overline{SHDN} deasserted		0.01	1.5		μA
Startup Time Response		Rising edge of V_{IN} or \overline{SHDN} to V_{OUT} within specification, $R_L = 68\Omega$, $SET = GND$, $I_{OUT} = 10mA$		20			μs
\overline{SHDN} Input Low Voltage	V_{IL}					$0.3 \times V_{IN}$	V
\overline{SHDN} Input High Voltage	V_{IH}			$0.7 \times V_{IN}$			V
\overline{SHDN} Input Current		$V_{\overline{SHDN}} = V_{IN}$ or V_{GND}	-1	0.1	+1		μA
Thermal-Shutdown Temperature	T_{SHDN}			180			$^\circ C$
Thermal-Shutdown Hysteresis	ΔT_{SHDN}			20			$^\circ C$
Line Regulation		$V_{OUT} = 1.5V$, $2.5V \leq V_{IN} \leq 5.5V$, $I_{OUT} = 10mA$		0.09			%/V
Load Regulation		$V_{OUT} = 1.5V$, $V_{IN} = 2.5V$, $1mA \leq I_{OUT} \leq 150mA$		0.2			%
Output Voltage Noise		10Hz to 100kHz, $C_{IN} = 0.1\mu F$, $I_{OUT} = 100mA$, $V_{OUT} = 1.5V$	MAX6469-MAX6476		150		μV_{RMS}
			MAX6477-MAX6484		75		
RESET CIRCUIT							
V_{OUT} Reset Threshold (V_{FB} for MAX6475/MAX6476/ MAX6483/MAX6484) (Note 5)	V_{THOUT}	MAX64_____A	90	92.5	95		% V_{OUT}
		MAX64_____B	85	87.5	90		
V_{OUT} to Reset Delay (V_{FB} for MAX6475/MAX6476/ MAX6483/MAX6484)				35			μs
Reset Timeout Period (Note 6)	t_{RP}	D1	2.5	3.75	5.0		ms
		D2	20	30	40		
		D3	150	225	300		
		D4	1200	1800	2400		

300mA LDO Linear Regulators with Internal Microprocessor Reset Circuit

ELECTRICAL CHARACTERISTICS (continued)

($V_{IN} = (V_{OUT} + 0.5V)$ or $+2.5V$, whichever is greater, $C_{OUT} = 3.3\mu F$, $T_A = -40^\circ C$ to $+85^\circ C$. Typical specifications are at $T_A = +25^\circ C$, unless otherwise noted.) (Note 2)

PARAMETER	SYMBOL	CONDITIONS	MIN	TYP	MAX	UNITS
\overline{MR} Input Low Voltage	V_{IL}				$0.3 \times V_{OUT}$	V
\overline{MR} Input High Voltage	V_{IH}	(Note 3)	$0.7 \times V_{OUT}$			V
\overline{MR} Minimum Input Pulse			1			μs
\overline{MR} Glitch Rejection				120		ns
\overline{MR} to Reset Delay				200		ns
\overline{MR} Pullup Resistance		\overline{MR} to OUT	25	40	70	$k\Omega$
\overline{RESET} Output Voltage (Open Drain)	V_{OL}	$V_{OUT} \geq 1.0V$, $I_{SINK} = 50\mu A$, \overline{RESET} asserted			0.3	V
		$V_{OUT} \geq 1.5V$, $I_{SINK} = 3.2mA$, \overline{RESET} asserted			0.4	
Open-Drain Reset Output Leakage Current	I_{LKG}	(Note 3)			1	μA
\overline{RESET} Output Voltage Push-Pull	V_{OL}	$V_{OUT} \geq 1.0V$, $I_{SINK} = 50\mu A$, \overline{RESET} asserted			0.3	V
		$V_{OUT} \geq 1.5V$, $I_{SINK} = 3.2mA$, \overline{RESET} asserted			0.4	
	V_{OH}	$V_{OUT} \geq 2.0V$, $I_{SOURCE} = 500\mu A$, \overline{RESET} deasserted	$0.8 \times V_{OUT}$			

Note 2: All devices are 100% production tested at $+25^\circ C$ and are guaranteed by correlation for $T_A = T_{MIN}$ to T_{MAX} .

Note 3: Guaranteed by design.

Note 4: Dropout voltage is defined as $(V_{IN} - V_{OUT})$ when V_{OUT} is 2% below the value of V_{OUT} for $V_{IN} = V_{OUT(NOM)} + 1V$.

Note 5: MAX6473/MAX6474/MAX6481/MAX6482 are guaranteed by design for $V_{OUT} < 2.5V$.

Note 6: Select the reset timeout period using the *Reset Timeout Delay Guide* (Table 3). Insert the appropriate suffix in the part number when ordering.

Typical Operating Characteristics

($V_{IN} = 5V$, $V_{OUT} = 3.3V$, $C_{OUT} = 3.3\mu F$, $T_A = +25^\circ C$, unless otherwise noted.)

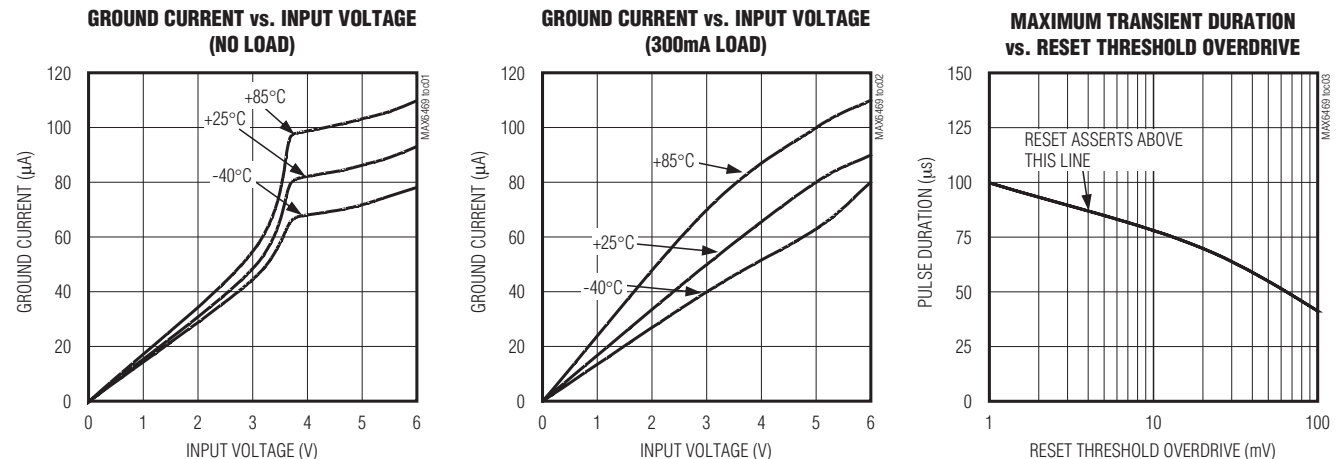

300mA LDO Linear Regulators with Internal Microprocessor Reset Circuit

Typical Operating Characteristics (continued)

($V_{IN} = 5V$, $V_{OUT} = 3.3V$, $C_{OUT} = 3.3\mu F$, $T_A = +25^\circ C$, unless otherwise noted.)

MAX6469-MAX6484

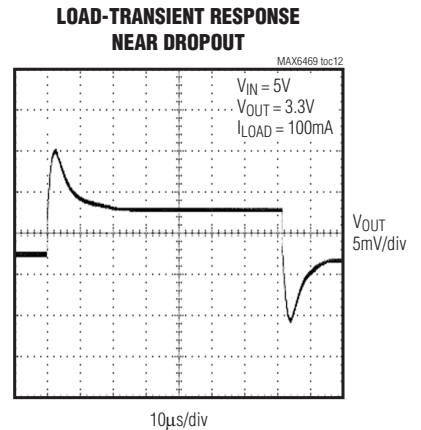
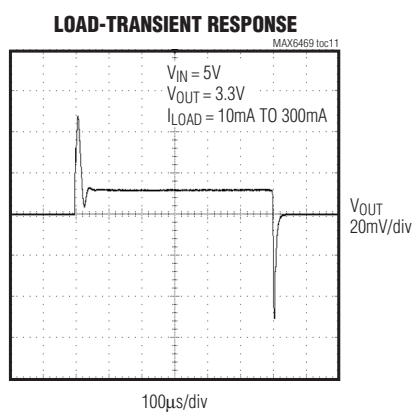
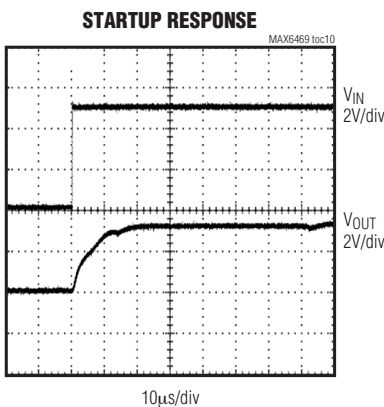
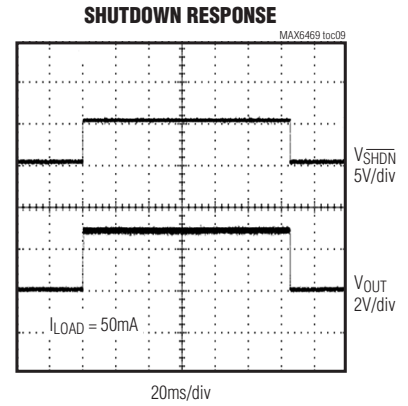
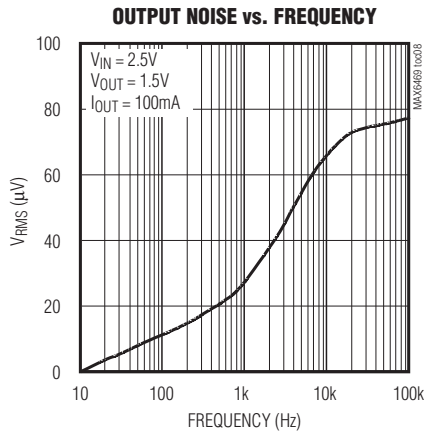
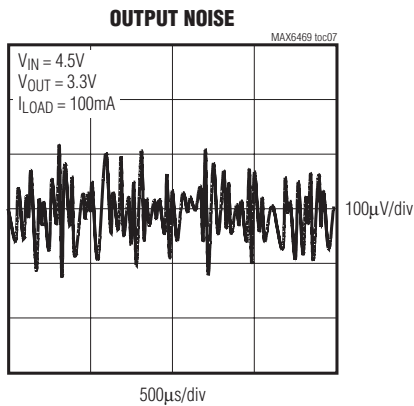
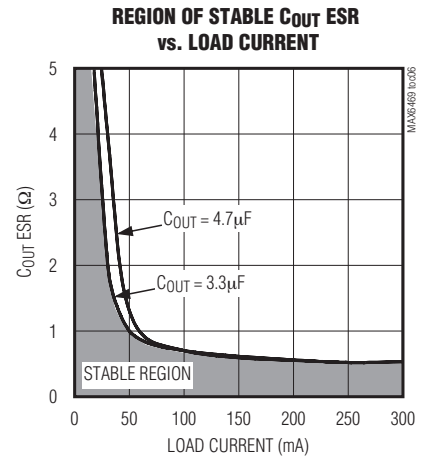
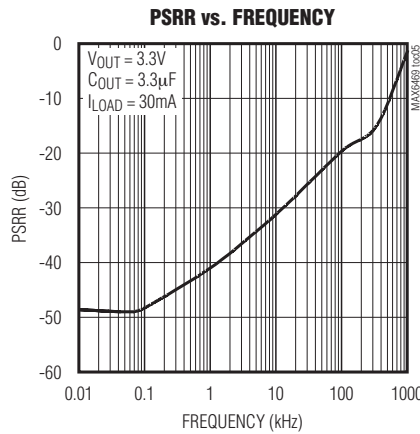
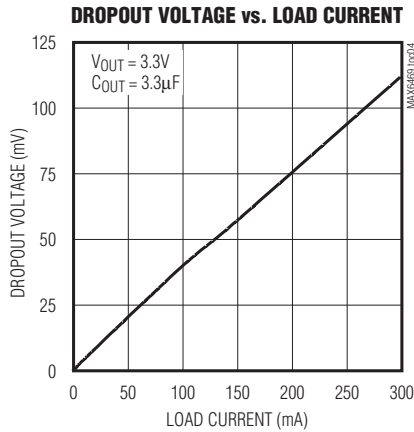

300mA LDO Linear Regulators with Internal Microprocessor Reset Circuit

Typical Operating Characteristics (continued)

($V_{IN} = 5V$, $V_{OUT} = 3.3V$, $C_{OUT} = 3.3\mu F$, $T_A = +25^\circ C$, unless otherwise noted.)

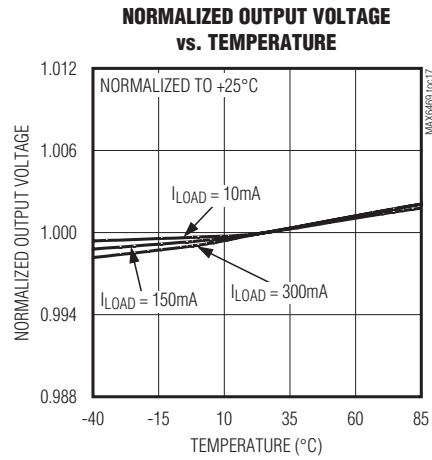
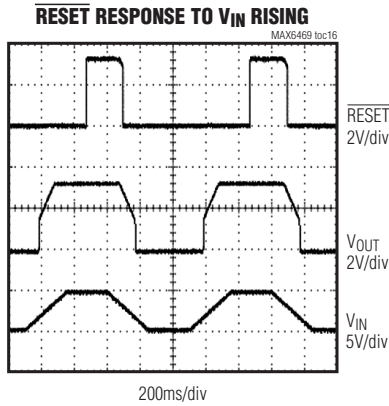
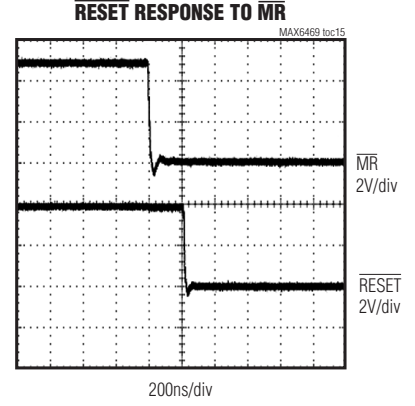
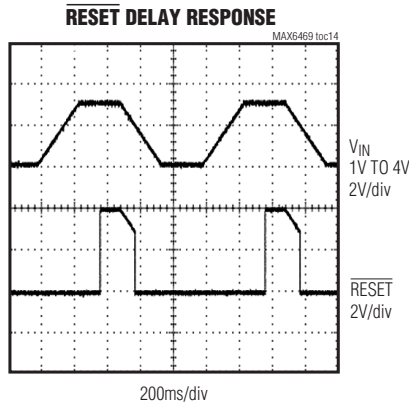
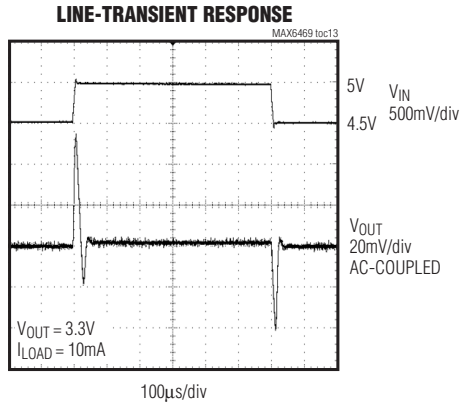

300mA LDO Linear Regulators with Internal Microprocessor Reset Circuit

MAX6469/MAX6470/MAX6477/MAX6478 Pin Description

PIN		BUMP	NAME	FUNCTION
MAX6469/MAX6470		MAX6477/MAX6478		
SOT23	TDFN-EP	UCSP		
1	1, 2	A1	IN	Regulator Input. Bypass IN to GND with a 0.1µF capacitor.
2	3	A2	GND	Ground. This pin also functions as a heatsink. Solder to large pads or the circuit-board ground plane to maximize thermal dissipation.
3	4	A3	$\overline{\text{SHDN}}$	Active-Low Shutdown Input. Connect $\overline{\text{SHDN}}$ to V_{IN} for normal operation.
4	5	C3	$\overline{\text{RESET}}$	Active-Low Reset Output. $\overline{\text{RESET}}$ remains low while V_{OUT} is below the reset threshold. $\overline{\text{RESET}}$ remains low for the duration of the reset timeout period after the reset conditions are terminated. $\overline{\text{RESET}}$ is available in open-drain and push-pull configurations.
5	6	C2	SET	Feedback Input for Externally Setting the Output Voltage. Connect SET to GND to select the preset output voltage. Connect SET to an external resistor-divider network for adjustable output operation.
6	7, 8	C1	OUT	Regulator Output. Bypass OUT to GND with a minimum 3.3µF low-ESR capacitor.
—	—	—	EP	Exposed Paddle (TDFN Only). EP is internally connected to GND. Connect EP to the ground plane to provide a low thermal-resistance path from the IC junction to the PCB. Do not use as the electrical connection to GND.

MAX6471/MAX6472/MAX6479/MAX6480 Pin Description

PIN		BUMP	NAME	FUNCTION
MAX6471/MAX6472		MAX6479/MAX6480		
SOT23	TDFN-EP	UCSP		
1	1, 2	A1	IN	Regulator Input. Bypass IN to GND with a 0.1µF capacitor.
2	3	A2	GND	Ground. This pin also functions as a heatsink. Solder to large pads or the circuit-board ground plane to maximize thermal dissipation.
3	4	A3	$\overline{\text{MR}}$	Active-Low Manual Reset Input. The reset output is asserted while $\overline{\text{MR}}$ is pulled low and remains asserted for the duration of the reset timeout period after $\overline{\text{MR}}$ transitions from low to high. Leave $\overline{\text{MR}}$ unconnected or connect to V_{OUT} if not used. $\overline{\text{MR}}$ has an internal pullup resistor of 40kΩ (typ) to V_{OUT} .
4	5	C3	$\overline{\text{RESET}}$	Active-Low Reset Output. $\overline{\text{RESET}}$ remains low while V_{OUT} is below the reset threshold or while $\overline{\text{MR}}$ is held low. $\overline{\text{RESET}}$ remains low for the duration of the reset timeout period after the reset conditions are terminated. $\overline{\text{RESET}}$ is available in open-drain and push-pull configurations.
5	6	C2	SET	Feedback Input for Externally Setting the Output Voltage. Connect SET to GND to select the preset output voltage. Connect SET to an external resistor-divider network for adjustable output operation.
6	7, 8	C1	OUT	Regulator Output. Bypass OUT to GND with a minimum 3.3µF low-ESR capacitor.
—	—	—	EP	Exposed Paddle (TDFN Only). EP is internally connected to GND. Connect EP to the ground plane to provide a low thermal-resistance path from the IC junction to the PCB. Do not use as the electrical connection to GND.

MAX6469-MAX6484

300mA LDO Linear Regulators with Internal Microprocessor Reset Circuit

MAX6473/MAX6474/MAX6481/MAX6482 Pin Description

PIN		BUMP	NAME	FUNCTION
MAX6473/MAX6474		MAX6481/MAX6482		
SOT23	TDFN-EP	UCSP		
1	1, 2	A1	IN	Regulator Input. Bypass IN to GND with a 0.1µF capacitor.
2	3	A2	GND	Ground. This pin also functions as a heatsink. Solder to large pads or the circuit-board ground plane to maximize thermal dissipation.
3	4	A3	$\overline{\text{SHDN}}$	Active-Low Shutdown Input. Connect $\overline{\text{SHDN}}$ to V_{IN} for normal operation.
4	5	C3	$\overline{\text{RESET}}$	Active-Low Reset Output. $\overline{\text{RESET}}$ remains low while V_{OUT} is below the reset threshold or while $\overline{\text{MR}}$ is held low. $\overline{\text{RESET}}$ remains low for the duration of the reset timeout period after the reset conditions are terminated. $\overline{\text{RESET}}$ is available in open-drain and push-pull configurations.
5	6	C2	$\overline{\text{MR}}$	Active-Low Manual Reset Input. The reset output is asserted while $\overline{\text{MR}}$ is pulled low and remains asserted for the duration of the reset timeout period after $\overline{\text{MR}}$ transitions from low to high. Leave $\overline{\text{MR}}$ unconnected or connect to V_{OUT} if not used. $\overline{\text{MR}}$ has an internal pullup resistor of 40kΩ (typ) to V_{OUT} .
6	7, 8	C1	OUT	Regulator Output. Bypass OUT to GND with a minimum 3.3µF (min) low-ESR capacitor.
—	—	—	EP	Exposed Paddle (TDFN Only). EP is internally connected to GND. Connect EP to the ground plane to provide a low thermal-resistance path from the IC junction to the PCB. Do not use as the electrical connection to GND.

MAX6475/MAX6476/MAX6483/MAX6484 Pin Description

PIN		BUMP	NAME	FUNCTION
MAX6475/MAX6476		MAX6483/MAX6484		
SOT23	TDFN-EP	UCSP		
1	1, 2	A1	IN	Regulator Input. Bypass IN to GND with a 0.1µF capacitor.
2	3	A2	GND	Ground. This pin also functions as a heatsink. Solder to large pads or the circuit-board ground plane to maximize thermal dissipation.
3	4	A3	$\overline{\text{SHDN}}$	Active-Low Shutdown Input. Connect $\overline{\text{SHDN}}$ to V_{IN} for normal operation.
4	5	C3	$\overline{\text{RESET}}$	Active-Low Reset Output. $\overline{\text{RESET}}$ remains low while FB is below the reset threshold. $\overline{\text{RESET}}$ remains low for the duration of the reset timeout period after the reset conditions are terminated. $\overline{\text{RESET}}$ is available in open-drain and push-pull configurations.
5	6	C2	FB	Feedback Input for Linear Regulator Controller or Remote Sense Applications. Connect FB to the external load (V_{CC}) to obtain the fixed output voltage.
6	7, 8	C1	OUT	Regulator Output. Bypass OUT to GND with a minimum 3.3µF low-ESR capacitor.
—	—	—	EP	Exposed Paddle (TDFN Only). EP is internally connected to GND. Connect EP to the ground plane to provide a low thermal-resistance path from the IC junction to the PCB. Do not use as the electrical connection to GND.

300mA LDO Linear Regulators with Internal Microprocessor Reset Circuit

Detailed Description

The MAX6469–MAX6484 are ultra-low, quiescent current, low-dropout linear regulators with an integrated microprocessor reset circuit. These devices guarantee 300mA (min) drive capabilities and are available with preset output voltages in 100mV increments between +1.5V and +3.3V. The internal reset circuit monitors the regulator output voltage and asserts the reset output when the regulator output is below the microprocessor supply tolerance.

Regulator

The regulator core operates with +2.5V to +5.5V input voltage range. The output voltage is offered in 100mV increments between +1.5V and +3.3V (contact factory for other output voltage options). The MAX6469–MAX6472/MAX6477–MAX6480 offer an adjustable output voltage implemented with an external resistor-divider network between OUT, SET, and GND (Figure 1). SET must be connected to either GND for fixed V_{OUT} or to an external divider for adjustable V_{OUT} . The MAX6469–MAX6472/MAX6477–MAX6480 automatically determine the feedback path depending on the connection of SET. The *Typical Operating Circuit* shows a typical connection for the MAX6469. OUT is an internally regulated low-dropout (LDO) linear regulator that powers a microprocessor.

Reset Circuit

The reset supervisor circuit is fully integrated in the MAX6469–MAX6484 and uses the same reference voltage as the regulator. Two supply tolerance reset thresholds, -7.5% and -12.5%, are provided for each type of device.

-7.5% Reset: Reset does not assert until the regulator output voltage is at least -5% out of tolerance and always asserts before the regulator output voltage is -10% out of tolerance.

-12.5% Reset: Reset does not assert until the regulator output voltage is at least -10% out of tolerance and always asserts before the regulator output voltage is -15% out of tolerance.

RESET Output

A μP 's reset input starts the μP in a known state. The MAX6469–MAX6484 μP supervisory circuits assert $\overline{\text{RESET}}$ during power-up, power-down, and brownout conditions. $\overline{\text{RESET}}$ asserts when the input voltage is below the undervoltage lockout threshold. $\overline{\text{RESET}}$ asserts when V_{OUT} is below the reset threshold and remains asserted for at least the minimum selected reset timeout period (t_{RP} , Table 3) after V_{IN} rises above the undervoltage lockout threshold and V_{OUT} rises above

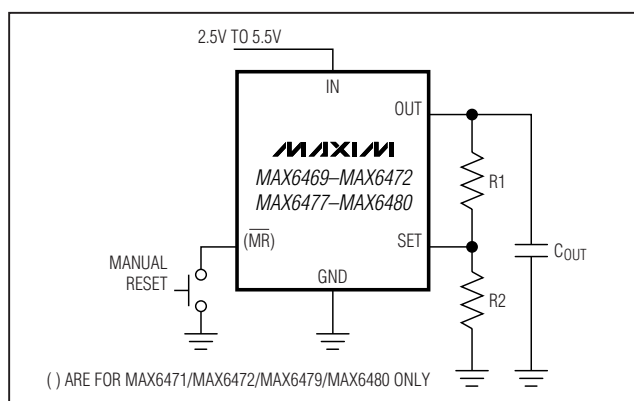

Figure 1. Adjustable Output Voltage Configuration

the reset threshold. $\overline{\text{RESET}}$ asserts when $\overline{\text{MR}}$ is pulled low (MAX6471–MAX6474/MAX6479–MAX6482). $\overline{\text{RESET}}$ asserts when $\overline{\text{SHDN}}$ is pulled low (MAX6469/MAX6470/MAX6473–MAX6478/MAX6481–MAX6484).

Shutdown (MAX6469/MAX6470/MAX6473–MAX6478/MAX6481–MAX6484 only)

$\overline{\text{SHDN}}$ allows the regulator to shut down, thereby reducing the total I_{IN} consumption of the device. $\overline{\text{SHDN}}$ provides a digitally controlled active-low shutdown. In shutdown mode, the pass transistor, control circuit, and reference turn off to reduce the supply current to below 0.1 μA . Connect $\overline{\text{SHDN}}$ to IN for normal operation.

Manual Reset Input (MAX6471–MAX6474/MAX6479–MAX6482 only)

Many μP -based products require manual reset capability, allowing the operator, a test technician, or external logic circuitry to initiate a reset. A logic low on $\overline{\text{MR}}$ asserts reset while the regulator output voltage is still within tolerance.

Reset remains asserted while $\overline{\text{MR}}$ is low and for the reset timeout period (t_{RP}) after $\overline{\text{MR}}$ returns high. The $\overline{\text{MR}}$ input has an internal pullup of 40k Ω (typ) to OUT. $\overline{\text{MR}}$ can be driven with TTL/CMOS logic levels or with open-drain/collector outputs. Connect a normally open switch from $\overline{\text{MR}}$ to GND to create a manual reset function; external debounce circuitry is not required. If $\overline{\text{MR}}$ is driven from long cables or the device is used in a noisy environment, connect a 0.1 μF capacitor from $\overline{\text{MR}}$ to GND to provide additional noise immunity.

Feedback Input (MAX6475/MAX6476/MAX6483/MAX6484 only)

The feedback input (FB) connects to an internal resistor-divider network (*Functional Diagram*). FB is not internally connected to V_{OUT} , and as a result can be used to

300mA LDO Linear Regulators with Internal Microprocessor Reset Circuit

remotely sense the output voltage of the device. Using FB with an external npn transistor, the current drive capability can be increased according to the following equation (Figure 2):

$$I_{OUT(TOTAL)} = I_{OUT} \times (\beta + 1)$$

The external npn pass transistor must meet specifications for current gain, power dissipation, and collector current. The beta influences the maximum output current the circuit can deliver. The largest guaranteed output current is given by $I_{LOAD(max)} = 300mA \times \beta$ (min). The transistor's rated power dissipation must exceed the actual power dissipated in the transistor. The power dissipated (PD) equals the maximum load current ($I_{LOAD(max)}$) times the maximum input-to-output voltage differential: $PD = I_{LOAD(max)} \times (V_{IN(max)} - V_{OUT})$. The rated transistor collector current must exceed the maximum load current.

Reverse Leakage Protection

Reverse OUT to IN Current

An internal circuit monitors the MAX6469-MAX6484 input and output voltages. When the output voltage is greater than the input voltage, the internal IN-to-OUT pass transistor and parasitic diode turn off. An external voltage applied to OUT does not reverse charge a battery or power source applied to IN (the leakage path from OUT to IN is 0.01µA typ). When the output voltage exceeds the input voltage, OUT powers the device and shutdown must be logic high (greater than 0.7 × V_{OUT}). RESET asserts until IN exceeds OUT and OUT is above the specified V_{THOUT} threshold (based on the selected or adjusted regulator OUT nominal voltage).

Reverse OUT to Ground Current

The MAX6469-MAX6484 maintain a low OUT-to-GND reverse-current flow when the IN power source is removed. When IN floats (input battery removed) and SHDN is pulled up to V_{OUT} (by an external diode), the

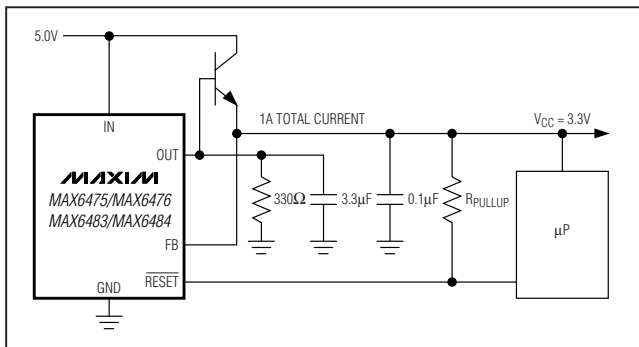

Figure 2. High-Current, External Transistor Application

OUT-to-GND current through the LDO is 40µA (typ). The regulator output can be held up with an external super capacitor or backup battery at OUT until the IN battery is replaced. The RESET output is asserted while the IN battery is removed to place the system in a low-power mode. Volatile memory content is maintained until the super capacitor or battery voltage drops below RAM standby specifications. RESET deasserts when the IN battery has been replaced and OUT exceeds the desired reset threshold. For nonrechargeable backup battery applications, place a reverse diode between OUT and the backup battery (to prevent battery charging). The external diode does not affect the regulator's dropout voltage because it is not between the LDO output and the processor/memory VCC supply. The diode can be replaced with a current-limiting resistor for rechargeable backup battery applications.

Current Limit

The MAX6469-MAX6484 include an internal current-limit circuit that monitors and controls the pass transistor's gate voltage, limiting the output current to 450mA (min). The output can be shorted to ground indefinitely without damaging the part.

Thermal Shutdown

When the junction temperature (T_J) exceeds +180°C (typ), the thermal sensor signals the shutdown logic, turning off the pass transistor and allowing the IC to

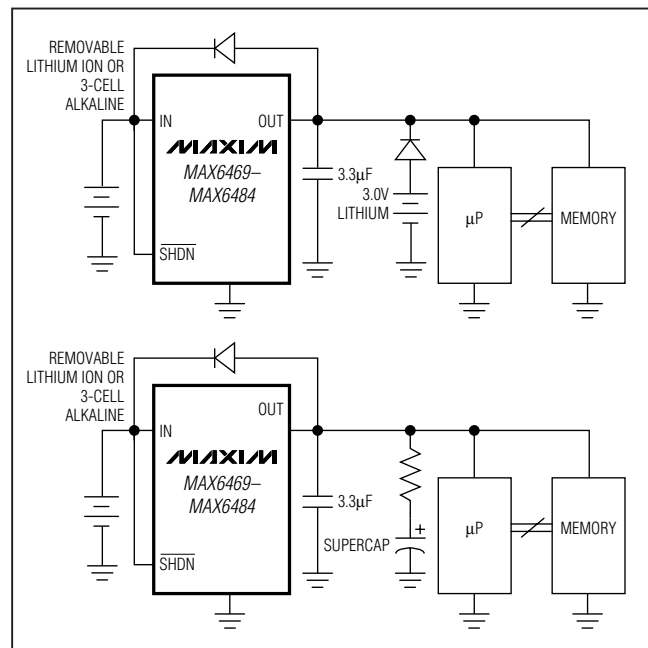

Figure 3. Battery Backup

300mA LDO Linear Regulators with Internal Microprocessor Reset Circuit

cool. The thermal sensor turns the pass transistor on again after the IC's junction temperature cools by 20°C, resulting in a pulsed output during continuous thermal overload conditions. Thermal overload protection is designed to protect the MAX6469–MAX6484 in the event of fault conditions. For continuous operation, do not exceed the absolute maximum junction temperature rating of $T_{JMAX} = +150^{\circ}\text{C}$.

Operating Region and Power Dissipation

The MAX6469–MAX6484's maximum power dissipation depends on the thermal resistance of the case and circuit board, the temperature difference between the die junction and the ambient air, and the rate of airflow. The power dissipation across the device is:

$$P = I_{OUT} (V_{IN} - V_{OUT})$$

The maximum power dissipation is:

$$P_{MAX} = (T_J - T_A) / (\theta_{JB} + \theta_{BA})$$

where $T_J - T_A$ is the temperature difference between the die junction and the surrounding air, θ_{JB} (or θ_{JC}) is the thermal resistance of the package, and θ_{BA} is the thermal resistance through the PC board, copper traces, and other materials to the surrounding air. The MAX6469–MAX6476 TDFN package $\theta_{JC} = 41^{\circ}\text{C}/\text{W}$, and the MAX6469–MAX6476 SOT package $\theta_{JC} = 110^{\circ}\text{C}/\text{W}$.

The MAX6469–MAX6484's ground pin (GND) performs the dual function of providing an electrical connection to the system ground and channeling heat away. Connect GND to the system ground using a large pad or ground plane. For continuous operation, do not exceed the absolute maximum junction temperature rating of $T_{JMAX} = +150^{\circ}\text{C}$.

Applications Information

Output Voltage Selection

The MAX6469–MAX6484 feature dual-mode operation: they operate in either a preset output voltage mode or an adjustable mode. In preset voltage mode, internal feedback resistors set the MAX6469–MAX6484's output from +1.5V to +3.3V (Table 1). Select this mode by connecting SET to ground (MAX6469–MAX6472/MAX6477–MAX6480). In adjustable mode, select an output between 1.25V and 5.5V using two external resistors connected as a voltage-divider to SET (Figure 1). The output voltage is set by the following equation:

$$V_{OUT} = V_{SET} (1 + R_1 / R_2)$$

where $V_{SET} = 1.23\text{V}$. To simplify resistor selection:

$$R_1 = R_2 (V_{OUT} / V_{SET} - 1)$$

Choose $R_2 = 50\text{k}\Omega$ to maintain stability, accuracy and high-frequency power-supply rejection. Avoid selecting resistor values greater than 100kΩ. In preset voltage mode, the impedance between SET and ground should always be less than 50kΩ. In most applications, connect SET directly to ground.

Low-Noise UCSP Output

MAX6477–MAX6484 UCSP products include internal filtering to yield low output noise without an additional external bypass capacitor. The devices yield 75μV_{RMS} (typ) output noise (for $V_{OUT} = 3.0\text{V}$) and 150μV_{RMS} (for $V_{OUT} = 3.3\text{V}$). This low-noise feature makes the MAX6477–MAX6484 ideal for audio applications.

Capacitor Selection and Regulator Stability

For stable operation over the full temperature range and with load currents up to 300mA, use a 3.3μF (min) ceramic output capacitor with an ESR <0.2Ω. To reduce noise and improve load transient response, stability, and power-supply rejection, use large output capacitor values such as 10μF.

Note that some ceramic capacitors exhibit large capacitance and ESR variation with temperature. With capacitor dielectrics such as Z5U and Y5V, use 4.7μF or more to ensure stability over temperature. With X7R or X5R capacitor dielectrics, 3.3μF should be sufficient at all operating temperatures. Higher ESR capacitors require more capacitance to maintain stability. A graph of the Region of Stable ESR vs. Load Current is shown in the *Typical Operating Characteristics*.

To improve power-supply rejection and transient response, use a 1μF capacitor between IN and GND.

The MAX6469–MAX6484 remain stable with purely resistive loads or current loads up to 300mA.

Reset Transient Immunity

The reset circuit is relatively immune to short-duration, falling V_{OUT} transients. The *Typical Operating Characteristics* section shows a graph of the Maximum Transient Duration vs. Reset Threshold Overdrive for which reset is not asserted. The graph was produced using falling V_{OUT} transients starting at V_{OUT} and ending below the reset threshold by the magnitude indicated (reset threshold overdrive). The graph shows the maximum pulse width that a falling V_{OUT} transient can typically have without triggering a reset pulse. As the amplitude of the transient increases (i.e., goes further below the reset threshold), the maximum allowable pulse width decreases. Typically, a V_{OUT} transient that goes only 10mV below the reset threshold and lasts for 75μs does not trigger a reset pulse.

300mA LDO Linear Regulators with Internal Microprocessor Reset Circuit

Power Dissipation Consideration

For the SOT23 package, any pin except the SET pin can be used as a heatsink. If the SET pin is used as a heatsink, excessive parasitic capacitance can affect stability. For the TDFN package, the exposed metal pad on the back side of a package connects to GND of the chip. This metal pad can be used as a heatsink.

UCSP Consideration

For general UCSP package information and PC layout considerations, refer to Maxim Application Note: *Wafer-Level Chip-Scale Package*.

UCSP Reliability

The chip-scale package (UCSP) represents a unique packaging form factor that might not perform equally to a packaged product through traditional mechanical reliability tests. CSP reliability is integrally linked to the user's assembly methods, circuit-board material, and usage environment. The user should closely review these areas when considering a CSP package. Performance through operating life test and moisture resistance remains uncompromised, because it is primarily determined by the wafer-fabrication process.

Mechanical stress performance is a greater consideration for a CSP package. CSPs are attached through direct solder contact to the user's PC board, forgoing the inherent stress relief of a packaged product's lead frame. Solder-joint contact integrity must be considered. Information on Maxim's qualification plan, test data, and recommendations are detailed in the UCSP application note on Maxim's website at www.maxim-ic.com.

Table 1. Output Voltage Suffix Guide

SUFFIX	OUTPUT VOLTAGE (V)
15	1.5
16	1.6
17	1.7
18	1.8
19	1.9
20	2.0
21	2.1
22	2.2
23	2.3
24	2.4
25	2.5
26	2.6
27	2.7
28	2.8
285	2.85
29	2.9
30	3.0
31	3.1
32	3.2
33	3.3

Note: Factory-trimmed custom output voltages may be available; contact factory for availability.

Table 2. Reset Threshold Accuracy Guide

SUFFIX	V _{OUT} RESET TOLERANCE (%)
A	-7.5
B	-12.5

Table 3. Reset Timeout Delay Guide

SUFFIX	MINIMUM RESET TIMEOUT PERIOD (ms)
D1	2.5
D2	20
D3	150
D4	1200

300mA LDO Linear Regulators with Internal Microprocessor Reset Circuit

Table 4. Standard Versions

DEVICE	TOP MARK
MAX6469 TA15BD3	ADO
MAX6469TA18AD3	ADP
MAX6469TA25BD3	ADQ
MAX6469TA28AD3	ACT
MAX6469TA30BD3	ADR
MAX6469TA33AD3	ADS
MAX6470 TA15BD3	ADT
MAX6470TA18AD3	ADU
MAX6470TA25BD3	ADV
MAX6470TA28AD3	ADW
MAX6470TA30BD3	ADY
MAX6470TA33AD3	ACU
MAX6471 TA15AD3	ADZ
MAX6471TA18BD3	AEA
MAX6471TA25AD3	AEB
MAX6471TA28BD3	AEC
MAX6471TA30AD3	AED
MAX6471TA33BD3	AEE
MAX6472 TA15AD3	AEF
MAX6472TA18BD3	ACW
MAX6472TA25AD3	AEG
MAX6472TA28BD3	AEH
MAX6472TA30AD3	AEI
MAX6472TA33BD3	AEJ
MAX6473 TA15AD3	AEK
MAX6473TA18BD3	AEL
MAX6473TA25AD3	AEM
MAX6473TA28BD3	AEN
MAX6473TA30AD3	AEO
MAX6473TA33BD3	AEP
MAX6474 TA15AD3	AEQ
MAX6474TA18BD3	AER
MAX6474TA25AD3	AES

DEVICE	TOP MARK
MAX6474TA28BD3	AET
MAX6474TA30AD3	AEU
MAX6474TA33BD3	AEV
MAX6475 TA15BD3	AEW
MAX6475TA18AD3	AEX
MAX6475TA25BD3	AEY
MAX6475TA28AD3	AEZ
MAX6475TA30BD3	AFA
MAX6475TA33AD3	ACZ
MAX6476 TA15BD3	AFB
MAX6476TA18AD3	AFC
MAX6476TA25BD3	AFD
MAX6476TA28AD3	AFE
MAX6476TA30BD3	AEF
MAX6476TA33AD3	AFG
MAX6477 BL15BD3	ABW
MAX6477BL18AD3	ABG
MAX6477BL25BD3	ABX
MAX6477BL28AD3	ABY
MAX6477BL30BD3	ABZ
MAX6477BL33AD3	ACA
MAX6478 BL15BD3	ACB
MAX6478BL18AD3	ACC
MAX6478BL25BD3	ACD
MAX6478BL28AD3	ACE
MAX6478BL30BD3	ACF
MAX6478BL33AD3	ACG
MAX6479 BL15AD3	ACH
MAX6479BL18BD3	ACI
MAX6479BL25AD3	ACJ
MAX6479BL28BD3	ACK
MAX6479BL30AD3	ACL
MAX6479BL33BD3	ACM

MAX6469-MAX6484

300mA LDO Linear Regulators with Internal Microprocessor Reset Circuit

Table 4. Standard Versions (continued)

DEVICE	TOP MARK
MAX6480 BL15BD3	ACN
MAX6480BL18AD3	ACO
MAX6480BL25BD3	ACP
MAX6480BL28AD3	ACQ
MAX6480BL30BD3	ACR
MAX6480BL33AD3	ABJ
MAX6481 BL15BD3	ACS
MAX6481BL18AD3	ACT
MAX6481BL25BD3	ACU
MAX6481BL28AD3	ACV
MAX6481BL30BD3	ACW
MAX6481BL33AD3	ACX
MAX6482 BL15BD3	ACY
MAX6482BL18AD3	ACZ
MAX6482BL25BD3	ADA

DEVICE	TOP MARK
MAX6482BL28AD3	ADB
MAX6482BL30BD3	ADC
MAX6482BL33AD3	ADD
MAX6483 BL15BD3	ADE
MAX6483BL18AD3	ADF
MAX6483BL25BD3	ADG
MAX6483BL28AD3	ADH
MAX6483BL30BD3	ADI
MAX6483BL33AD3	ADJ
MAX6484 BL15BD3	ADK
MAX6484BL18AD3	ADL
MAX6484BL25BD3	ADM
MAX6484BL28AD3	ADN
MAX6484BL30BD3	ADO
MAX6484BL33AD3	ADP

Sample stock is generally available on standard versions only. Standard versions require a minimum order increment of 2.5k units. Nonstandard versions must be ordered in 10k-unit increments. Contact factory for availability.

300mA LDO Linear Regulators with Internal Microprocessor Reset Circuit

Pin Configurations

MAX6469-MAX6484

TOP VIEW

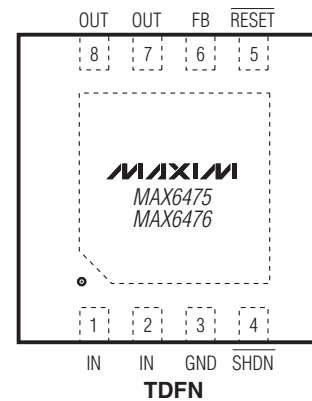
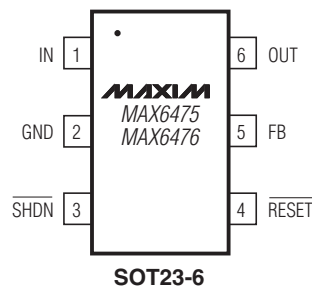
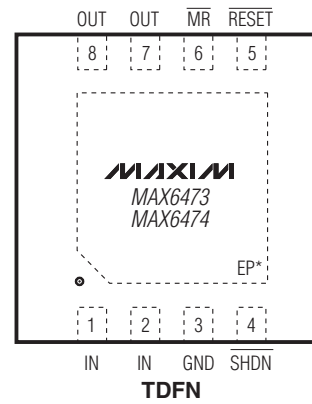
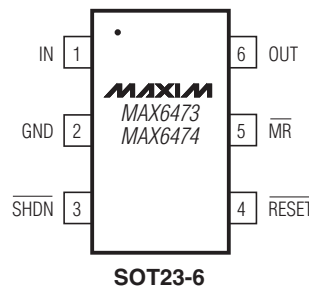
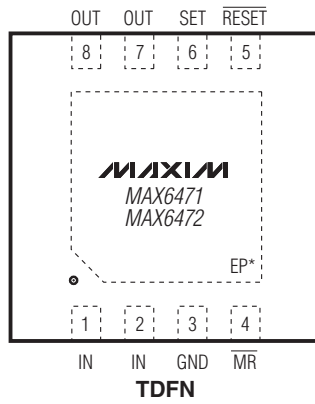
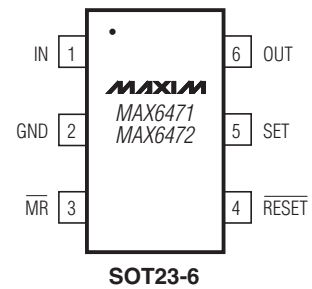
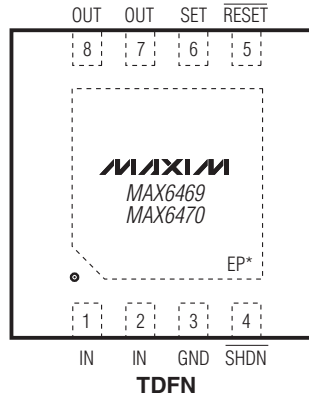
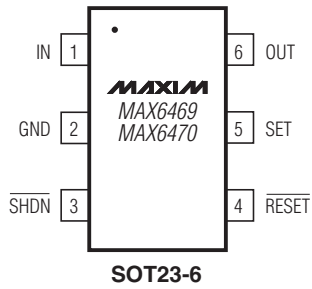

*EP = EXPOSED PAD.

300mA LDO Linear Regulators with Internal Microprocessor Reset Circuit

Pin Configurations (continued)

TOP VIEW

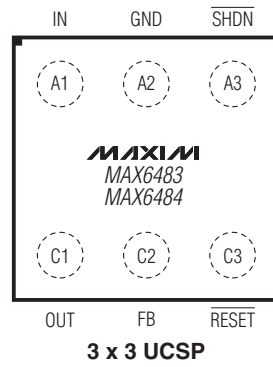
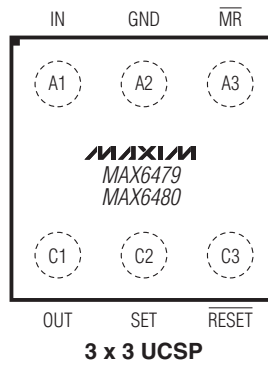
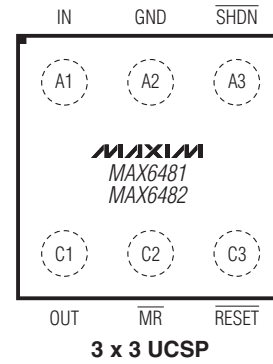
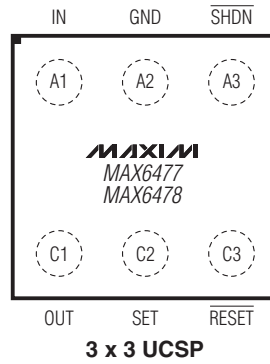

UCSP DEVICES SHOWN AS
MOUNTED ON PC BOARD.
BALL SOLDERED DOWN.

300mA LDO Linear Regulators with Internal Microprocessor Reset Circuit

Functional Diagrams

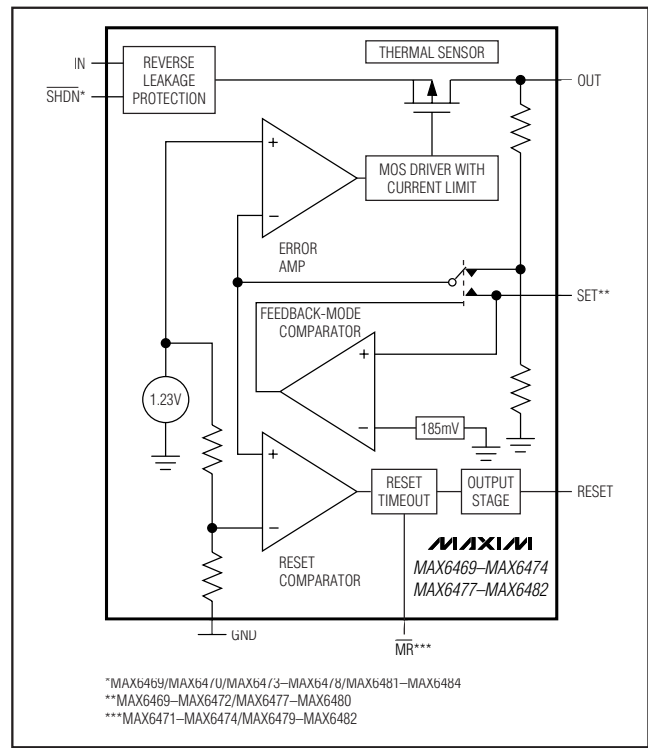
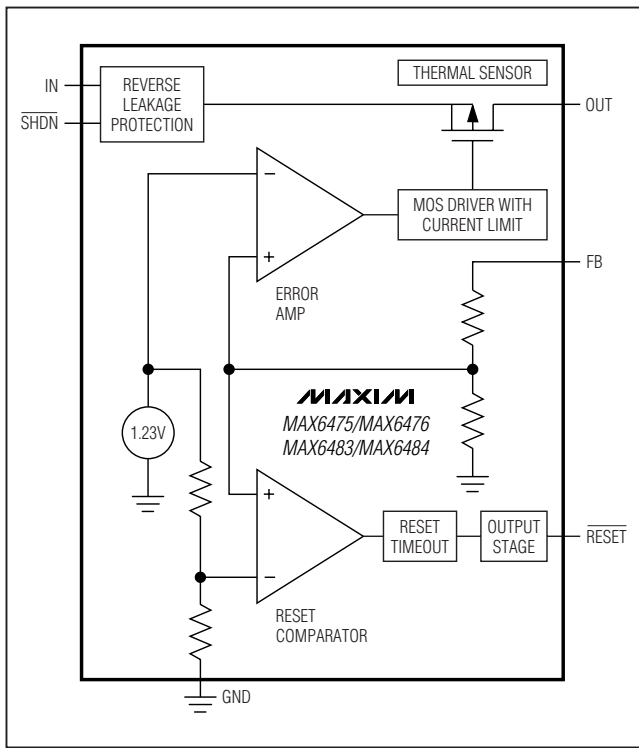

MAX6469-MAX6484

Typical Operating Circuit

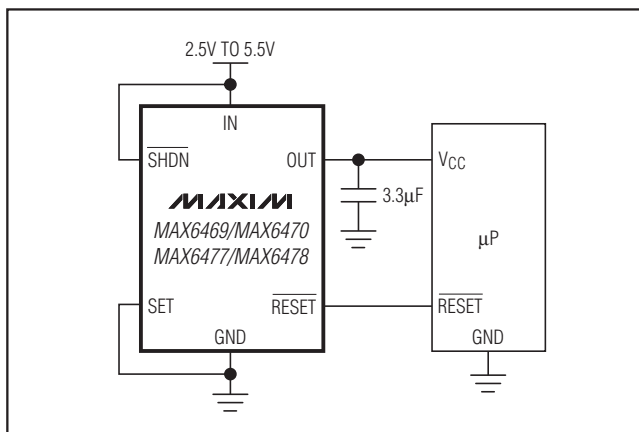

Chip Information

PROCESS: BiCMOS

300mA LDO Linear Regulators with Internal Microprocessor Reset Circuit

Ordering Information (continued)

PART*	TEMP RANGE	PIN-PACKAGE
MAX6471UT__D_-T	-40°C to +85°C	6 SOT23-6
MAX6471TA__D_-T**	-40°C to +85°C	8 TDFN-EP***
MAX6472UT__D_-T	-40°C to +85°C	6 SOT23-6
MAX6472TA__D_-T**	-40°C to +85°C	8 TDFN-EP***
MAX6473UT__D_-T	-40°C to +85°C	6 SOT23-6
MAX6473TA__D_-T**	-40°C to +85°C	8 TDFN-EP***
MAX6474UT__D_-T	-40°C to +85°C	6 SOT23-6
MAX6474TA__D_-T**	-40°C to +85°C	8 TDFN-EP***
MAX6475UT__D_-T	-40°C to +85°C	6 SOT23-6
MAX6475TA__D_-T**	-40°C to +85°C	8 TDFN-EP***

PART*	TEMP RANGE	PIN-PACKAGE
MAX6476UT__D_-T	-40°C to +85°C	6 SOT23-6
MAX6476TA__D_-T**	-40°C to +85°C	8 TDFN-EP***
MAX6477BL__D_-T	-40°C to +85°C	6 UCSP-6
MAX6478BL__D_-T	-40°C to +85°C	6 UCSP-6
MAX6479BL__D_-T	-40°C to +85°C	6 UCSP-6
MAX6480BL__D_-T	-40°C to +85°C	6 UCSP-6
MAX6481BL__D_-T	-40°C to +85°C	6 UCSP-6
MAX6482BL__D_-T	-40°C to +85°C	6 UCSP-6
MAX6483BL__D_-T	-40°C to +85°C	6 UCSP-6
MAX6484BL__D_-T	-40°C to +85°C	6 UCSP-6

*Devices are also available in a lead(Pb)-free/RoHS-compliant packages. Specify lead(Pb)-free by substituting a +T instead of a -T when ordering.

**Future product—contact factory for availability.

***EP = Exposed pad.

Note: The first “_” are placeholders for the output voltage levels of the devices. Desired output voltages are set by the suffix found in the Output Voltage Suffix Guide (Table 1). The third “_” is a placeholder for the reset threshold accuracy. Desired reset threshold accuracy is set by the suffix found in the Reset Threshold Accuracy Guide (Table 2). The “_” following the D is a placeholder for the reset timeout delay time. Desired reset timeout delay time is set by the suffix found in the Reset Timeout Delay Guide (Table 3). For example, the MAX6481BL30BD4-T has a 3.0V output voltage, 12.5% reset threshold tolerance, and a 1200ms (min) reset timeout delay. Sample stock is generally available on standard versions only (Table 4). Standard versions require a minimum order increment of 2.5k units. Nonstandard versions must be ordered in 10k-unit increments. Contact factory for availability.

Selector Guide

PART	SET	SHDN	MR	FB	PUSH-PULL RESET	OPEN-DRAIN RESET	PACKAGE
MAX6469	√	√	—	—	√	—	SOT23-6/8-TDFN
MAX6470	√	√	—	—	—	√	SOT23-6/8-TDFN
MAX6471	√	—	√	—	√	—	SOT23-6/8-TDFN
MAX6472	√	—	√	—	—	√	SOT23-6/8-TDFN
MAX6473	—	√	√	—	√	—	SOT23-6/8-TDFN
MAX6474	—	√	√	—	—	√	SOT23-6/8-TDFN
MAX6475	—	√	—	√	√	—	SOT23-6/8-TDFN
MAX6476	—	√	—	√	—	√	SOT23-6/8-TDFN
MAX6477	√	√	—	—	√	—	3 x 3 UCSP B9-3
MAX6478	√	√	—	—	—	√	3 x 3 UCSP B9-3
MAX6479	√	—	√	—	√	—	3 x 3 UCSP B9-3
MAX6480	√	—	√	—	—	√	3 x 3 UCSP B9-3
MAX6481	—	√	√	—	√	—	3 x 3 UCSP B9-3
MAX6482	—	√	√	—	—	√	3 x 3 UCSP B9-3
MAX6483	—	√	—	√	√	—	3 x 3 UCSP B9-3
MAX6484	—	√	—	√	—	√	3 x 3 UCSP B9-3

300mA LDO Linear Regulators with Internal Microprocessor Reset Circuit

Package Information

For the latest package outline information and land patterns (footprints), go to www.maxim-ic.com/packages. Note that a "+", "#", or "-" in the package code indicates RoHS status only. Package drawings may show a different suffix character, but the drawing pertains to the package regardless of RoHS status.

PACKAGE TYPE	PACKAGE CODE	OUTLINE NO.	LAND PATTERN NO.
6 SOT23-6	U6F-6	21-0058	90-0175
8 TDFN-EP	T833-2	21-0137	90-0059
6 UCSP	B9-3	21-0093	—

MAX6469-MAX6484