

Four-Channel Thermistor Temperature-to-Pulse-Width Converter

General Description

The MAX6691 four-channel thermistor temperature-to-pulse-width converter measures the temperatures of up to four thermistors and converts them to a series of output pulses whose widths are related to the thermistors' temperatures. Each of the four thermistors and an external fixed resistor (R_{EXT}) form a voltage-divider that is driven by the MAX6691's internal voltage reference (V_{REF}). V_{REF} and the voltage across R_{EXT} are measured and converted to a pulse.

The MAX6691 has a single open-drain I/O pin that can be readily connected to a variety of microcontrollers. The microcontroller initiates a conversion by pulling the I/O pin low and releasing it. When conversion is done, the MAX6691 signals the end of conversion by pulling the I/O pin low once again. The pulse corresponding to the first thermistor is sent immediately after the release of the I/O pin.

The on-chip power-management circuitry reduces the average thermistor current to minimize errors due to thermistor self-heating. Between conversions, the MAX6691 falls into a $10\mu\text{A}$ (max) sleep mode, where the voltage reference is disabled and the supply current is at its minimum.

The MAX6691 is available in a 10-pin μMAX package and is specified from -55°C to $+125^\circ\text{C}$ temperature range.

Applications

HVAC
Home Appliances
Medical Devices

Typical Application Circuit

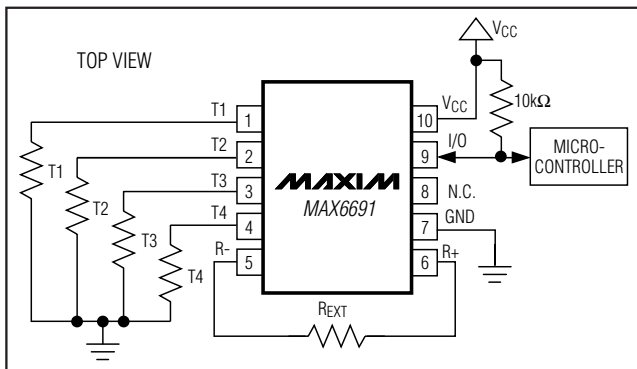

Features

- ◆ Simple Single-Wire Interface
- ◆ Measures Up to Four Thermistor Temperatures
- ◆ Low-Average Thermistor Current Minimizes Self-Heating Errors
- ◆ Internal Voltage Reference Isolates Thermistor from Power-Supply Noise
- ◆ Accommodates Any Thermistor Temperature Range

Ordering Information

PART	TEMP RANGE	PIN-PACKAGE	PKG CODE
MAX6691MUB	-55°C to $+125^\circ\text{C}$	10 μMAX	U10-2

Pin Configuration

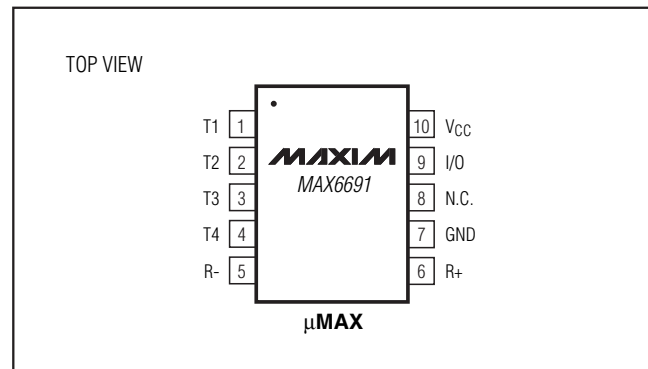

Four-Channel Thermistor Temperature-to-Pulse-Width Converter

ABSOLUTE MAXIMUM RATINGS

V _{CC} to GND	-0.3V to +6.0V
All Other Pins to GND	-0.3V to (V _{CC} + 0.3V)
I/O, R+, R-, T1–T4 Current	±20mA
ESD Protection (Human Body Model)	±2000V
Continuous Power Dissipation (T _A = +70°C)	
10-Pin μMAX (derate 5.6mW/°C above +70°C)	444.4mW

Operating Temperature Range	-55°C to +125°C
Junction Temperature	+150°C
Storage Temperature Range	-65°C to +150°C
Lead Temperature (soldering, 10s)	+300°C

Stresses beyond those listed under "Absolute Maximum Ratings" may cause permanent damage to the device. These are stress ratings only, and functional operation of the device at these or any other conditions beyond those indicated in the operational sections of the specifications is not implied. Exposure to absolute maximum rating conditions for extended periods may affect device reliability.

ELECTRICAL CHARACTERISTICS

(V_{CC} = 3.0V to 5.5V, T_A = -55°C to +125°C, unless otherwise noted. Typical values are specified at V_{CC} = 3.3V and T_A = +25°C.) (Note1)

PARAMETER	SYMBOL	CONDITIONS	MIN	TYP	MAX	UNITS
T _{HIGH} /T _{LOW} Accuracy	V _{REXT}	T _A = +25°C, V _{CC} = 3.3V			0.5	% FS
		T _A = T _{MIN} to T _{MAX}			1.0	
Supply Voltage Range	V _{CC}		3.0		5.5	V
Supply Current	I _{CC}	During conversion, no load		300	600	μA
Sleep-Mode Supply Current	I _{STANDBY}			3.5	10	μA
Input Leakage Current	I _{LEAKAGE}				1.0	μA
Reference Voltage Output	V _{REF}	I _{REF} = 1mA, T _A = +25°C	1.19	1.24	1.32	V
Reference Load Regulation		0 < I _{REF} < 2mA		0.1	0.2	%
Reference Supply Rejection				0.2		%
Logic Input Low Voltage	V _{IL}				0.3 × V _{CC}	V
Logic Input High Voltage	V _{IH}		0.7 × V _{CC}			V

TIMING CHARACTERISTICS

(V_{CC} = 3.0V to 5.5V, T_A = -55°C to +125°C, unless otherwise noted. Typical values are specified at V_{CC} = 3.3V and T_A = +25°C.) (Figure 1) (Note1)

PARAMETER	SYMBOL	CONDITIONS	MIN	TYP	MAX	UNITS
Glitch Immunity on I/O Input				500		ns
Conversion Time	t _{CONV}		86	102	156	ms
Nominal Pulse Width	t _{LOW}		4.0	4.9	7.5	ms
Start Pulse Width	t _{START}		5			μs
Data Ready Pulse Width	t _{READY}		103	122	188	μs
Error Pulse Width	t _{ERROR}		103	122	188	μs
Rise Time	t _{RISE}	C _L = 15pF, R _L = 10kΩ		600		ns
Fall Time	t _{FALL}	C _L = 15pF, R _L = 10kΩ		600		ns

Note 1: Specification limits over temperature are guaranteed by design, not production tested.

Four-Channel Thermistor Temperature-to-Pulse-Width Converter

Typical Operating Characteristics

($V_{CC} = 5V$, $R_{EXT} = 7.5k\Omega$, $R_{TH} = 12.5k\Omega$, $T_A = +25^\circ C$, unless otherwise noted.)

MAX6691

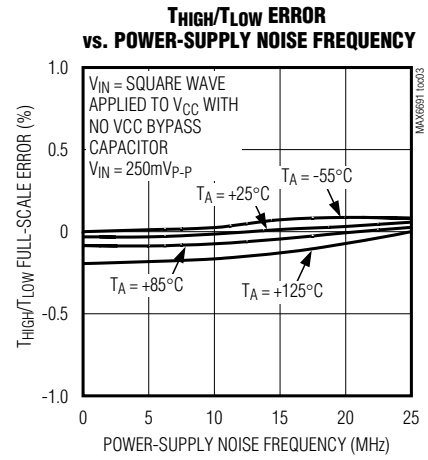
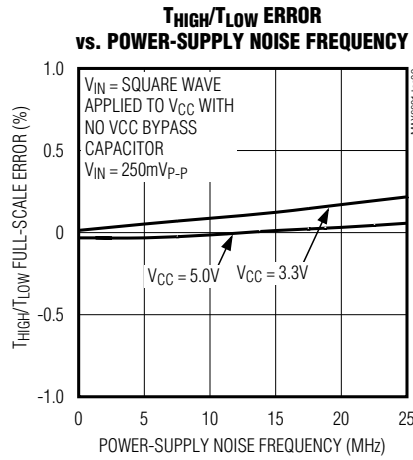
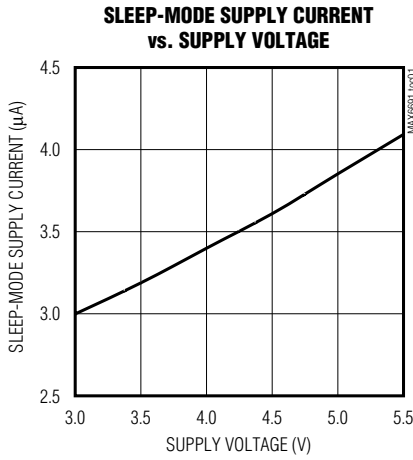

Pin Description

PIN	NAME	FUNCTION
1	T1	Thermistor 1. Connect to external thermistor 1.
2	T2	Thermistor 2. Connect to external thermistor 2.
3	T3	Thermistor 3. Connect to external thermistor 3.
4	T4	Thermistor 4. Connect to external thermistor 4.
5	R-	External Resistor Low Side. Connect R_{EXT} between R- and R+.
6	R+	Reference Voltage Output. Connect R_{EXT} between R- and R+.
7	GND	Ground. Ground connection for MAX6691 and ground return for external thermistor(s).
8	N.C.	No Connection. Do not make a connection to this pin.
9	I/O	I/O Connection to Microcontroller. Connect a $10k\Omega$ pullup resistor from I/O pin to V_{CC} .
10	V_{CC}	Supply Voltage. Bypass V_{CC} to GND with a capacitor of at least $0.1\mu F$.

Four-Channel Thermistor Temperature-to-Pulse-Width Converter

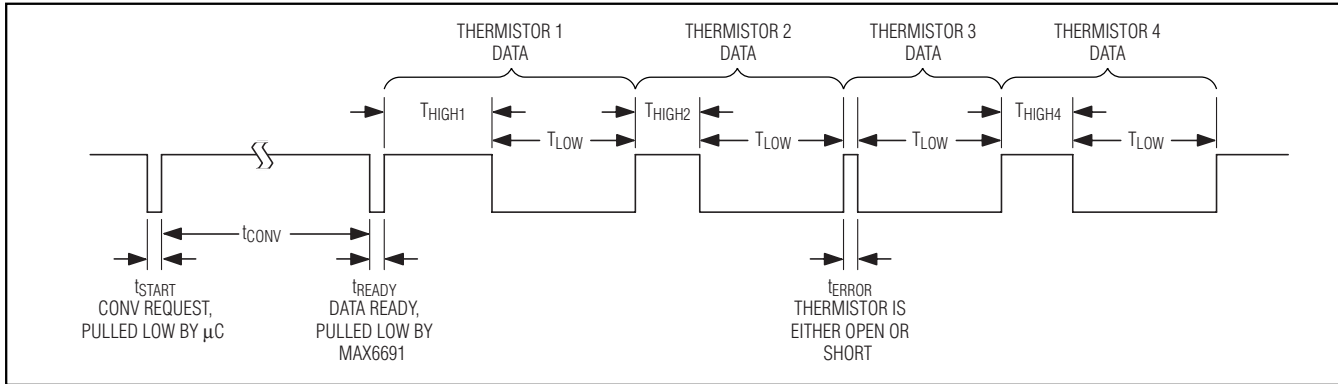

Figure 1. Timing Diagram

Detailed Description

The MAX6691 is an interface circuit that energizes up to four thermistors and converts their temperatures to a series of output pulses. The MAX6691 powers the thermistors only when a measurement is being made. This minimizes the power dissipation in the thermistors, virtually eliminating self-heating, a major component of thermistor error. The simple I/O allows the initiation of conversion and delivery of output pulses or a single pin.

Temperature Measurement

When it is not performing conversions or transmitting output pulses, the MAX6691 is in a low-power sleep mode and the I/O pin is held at V_{CC} by the external pullup resistor (typically 10kΩ). To initiate measurement of up to four thermistor temperatures, the external microcontroller pulls the I/O pin low for at least 5μs (Figure 1). When the microcontroller releases the I/O pin, the MAX6691 applies the reference voltage (V_{REF}) to the external resistor (R_{EXT}), which is connected sequentially to each of the four external thermistors (T1 through T4).

When the measurements are complete (after a period equal to T_{CONV}), the MAX6691 pulls the I/O pin low for 125μs. The I/O pin remains high for a period proportional to the first V_{EXT} measurement (corresponding to the first thermistor). The MAX6691 then pulls the I/O pin low for a period proportional to V_{REF}. Three more high/low pulse pairs follow, corresponding to T2 through T4, after which the I/O pin is released.

The relationship between pulse width, R_{EXT}, and thermistor resistance (R_{TH}) can be described as:

$$\frac{T_{HIGH}}{T_{LOW}} = \frac{V_{EXT}}{V_{REF}} - 0.0002 = \frac{R_{EXT}}{R_{EXT} + R_{TH}} - 0.0002$$

The relationship between V_{EXT} and the temperature of a thermistor is determined by the values of R_{EXT} and the thermistor's characteristics. If the relationship between R_{TH} and the temperature is known, a microcontroller with no on-chip ADC can measure T_{HIGH} and T_{LOW} and accurately determine the temperature at the corresponding thermistor.

For each operation, the MAX6691 generates four pulses on the I/O pin. In the case of an open or short connection on the thermistor, the corresponding pulse (T_{HIGH}) is a short pulse of less than 5% of T_{LOW}.

Applications Information

Thermistors and Thermistor Selection

Either NTC or PTC thermistors can be used with the MAX6691, but NTC thermistors are more commonly used. NTC thermistors are resistive temperature sensors whose resistance decreases with increasing temperature. They are available in a wide variety of packages that are useful in difficult applications such as measurement of air or liquid temperature. Some can operate over temperature ranges beyond that of most ICs. The relationship between temperature and resistance in an NTC thermistor is very nonlinear and can be described by the following approximation:

$$\frac{1}{T} = A + B(\ln R) + C(\ln R)^3$$

Where T is absolute temperature, R is the thermistor's resistance, and A, B, C are coefficients that vary with manufacturer and material characteristics. The general shape of the curve is shown in Figure 2.

Four-Channel Thermistor Temperature-to-Pulse-Width Converter

MAX6691

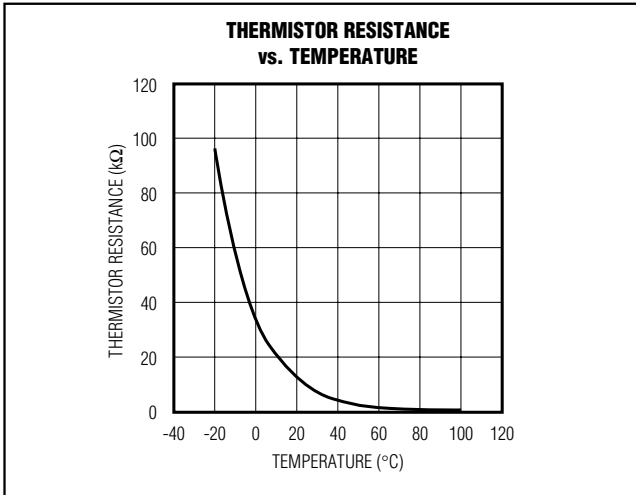

Figure 2. Thermistor Resistance vs. Temperature

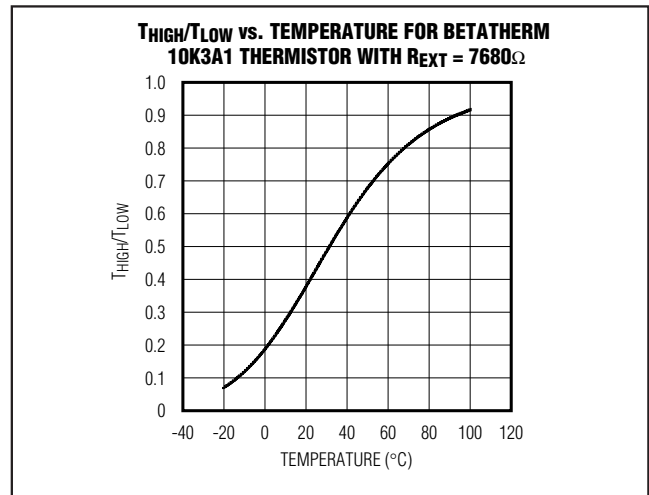

Figure 4. THIGH/TLOW vs. Temperature, REXT = 7680Ω

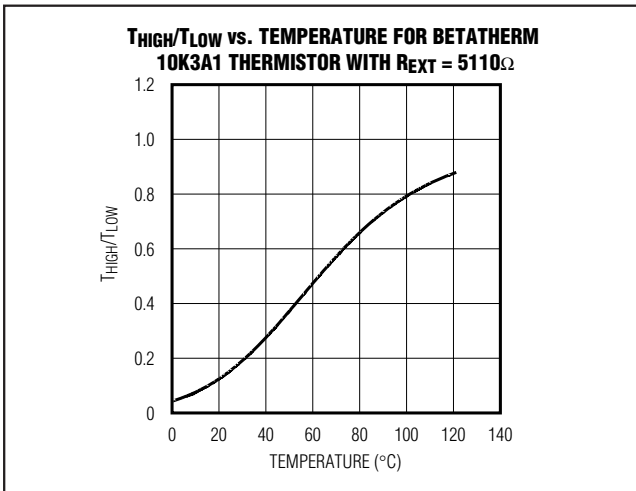

Figure 3. THIGH/TLOW vs. Temperature, REXT = 5110Ω

The relationship between temperature and resistance of an NTC thermistor is highly nonlinear. However, by connecting the thermistors in series with a properly chosen resistor (REXT) and using the MAX6691 to measure the voltage across the resistor, a reasonably linear transfer function can be obtained over a limited temperature range. Linearity improves for smaller temperature ranges.

Figures 3 and 4 show typical THIGH/TLOW curves for a standard thermistor in conjunction with values of REXT chosen to optimize linearity over two series resistors chosen to optimize linearity over two different temperature ranges.

NTC thermistors are often described by the resistance at +25°C. Therefore, a 10kΩ thermistor has a resistance of 10kΩ at +25°C. When choosing a thermistor, ensure that the thermistor's minimum resistance (which occurs at the maximum expected operating temperature) in series with REXT does not cause the voltage reference output current to exceed about 1mA. Some standard 10kΩ thermistors with similar characteristics are listed in Table 1.

Choosing REXT

Choose REXT to minimize nonlinearity errors from the thermistor:

- 1) Decide on the temperature range of interest (for example 0°C to +70°C).
- 2) Find the thermistor values at the limits of the temperature range. RMIN is the minimum thermistor value (at the maximum temperature) and RMAX is the maximum thermistor value (at the minimum temperature). Also find RMID, the thermistor resistance in the middle of the temperature range (+35°C for the 0°C to +70°C range).
- 3) Find REXT using the equation below:

$$R_{EXT} = \frac{R_{MID}(R_{MIN} + R_{MAX}) - 2R_{MIN} \times R_{MAX}}{R_{MIN} + R_{MAX} - 2R_{MID}}$$

Power-Supply Considerations

The MAX6691 accuracy is relatively unaffected by power-supply coupled noise. In most applications,

Four-Channel Thermistor Temperature-to-Pulse-Width Converter

Table 1. Standard Thermistors

MANUFACTURER	PART	WEBSITE
Betatherm	10K3A1	www.betatherm.com/indexna.htm
Dale	1M1002	www.vishay.com/brands/dale/main.html
Thermometrics	C100Y103J	www.thermometrics.com

bypass V_{CC} to GND by placing a 0.1µF to 1.0µF ceramic bypass capacitor close to the supply pin of the devices.

Thermal Considerations

Self-heating degrades the temperature measurement accuracy of thermistors. The amount of self-heating depends on the power dissipated and the dissipation constant of the thermistor. Dissipation constants depend on the thermistor's package and can vary considerably.

A typical thermistor might have a dissipation constant equal to 1mW/°C. For every milliwatt the thermistor dissipates, its temperature rises by 1°C. For example, consider a 10kΩ (at +25°C) NTC thermistor in series with a 5110Ω resistor operating +40°C with a constant 5V bias. If it is one of the standard thermistors previously mentioned, its resistance is 5325Ω at this temperature. The power dissipated in the thermistor is:

$$(5V)^2 (5325\Omega) / (5325\Omega + 5110\Omega)^2 = 1.22mW$$

This thermistor therefore has a self-heating error at +40°C of 1.22°C. Because the MAX6691 uses a small reference voltage and energizes each thermistor for only about 25ms per conversion cycle, the self-heating of the thermistor under the same conditions when used with the MAX6691 is far less. Assuming one conversion cycle every 5s, each thermistor is energized only 0.5% of the time:

$$(1.22)^2 (5325)(0.005) / (5325 + 5110)^2 = 0.364\mu W, \text{ or only about } 0.00036^\circ C \text{ self-heating error.}$$

Chip Information

TRANSISTOR COUNT: 7621

PROCESS: BiCMOS

Functional Diagram

