

MAX7037 Evaluation Kits

Evaluate: MAX7037

General Description

The MAX7037 evaluation kits (EV kits) are fully assembled and tested to evaluate the MAX7037 sub-1GHz, ultra-low-power, RF ISM transceiver. The EV kits are connected to the PC through a Siam Kitty board. The EV kits get power from the Siam Kitty board and run from a minimum supply voltage of only 2.1V.

A particular EV kit will only work at a specific carrier frequency. The frequencies supported are: 315MHz, 434MHz, 868MHz, 902MHz, 915MHz, and 928MHz. EV kits are shipped configured for 315MHz, 434MHz, 868MHz, 902MHz, 915MHz, or 928MHz operation. It is necessary to change the RF matching components to configure an EV kit to work at one of the other frequencies. Further details are provided in the [Changing EV Kit for Operation at Other Frequencies](#) section.

Note that, if an EV kit is used at a frequency other than that for which it is configured, it will likely either not work at all or display very poor performance. Ensure that both EV kits match the frequency for which they are configured. Furthermore, the MAX7037_915MHz EV kit can be used for 902MHz, 915MHz, or 928MHz operation.

MAX7037_315MHz EV Kit Board Photo

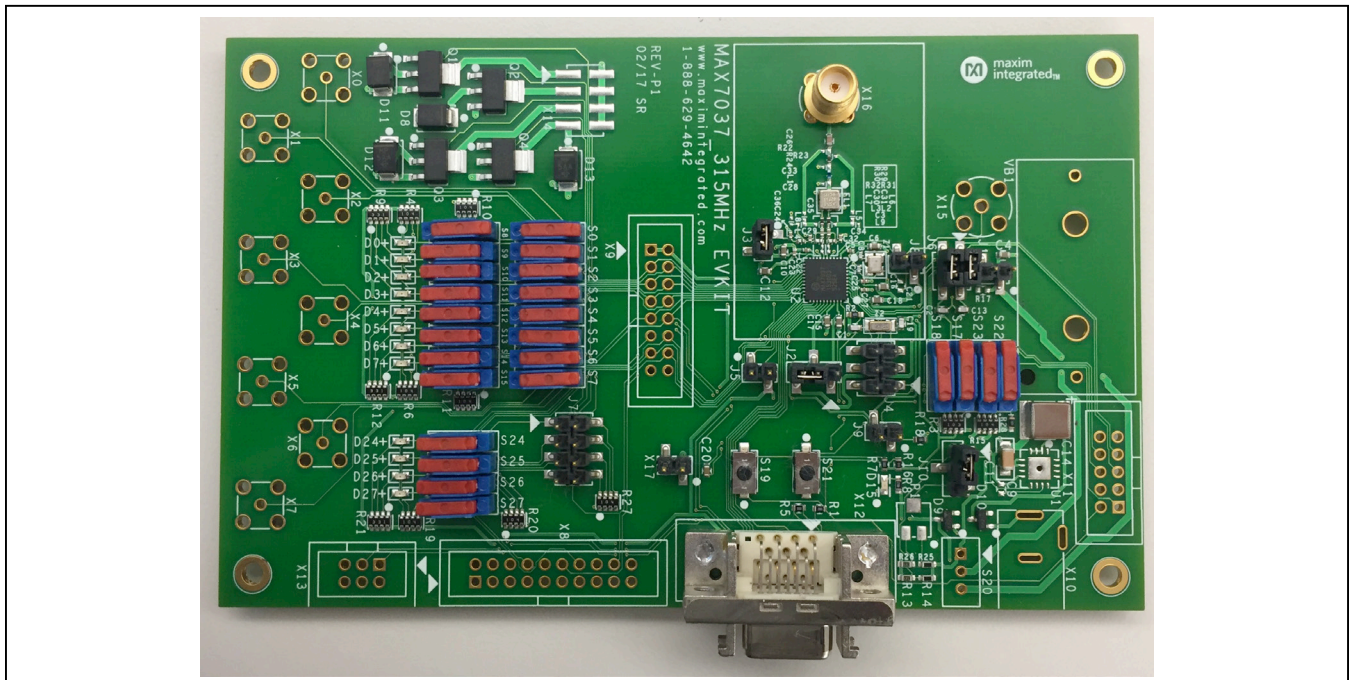

Features

- Easy Evaluation of the MAX7037
- Proven PCB Layout
- Fully Assembled and Tested

EV Kit Contents

- Assembled circuit board including MAX7037.
- Assembled Siam Kitty Board.
- 14 POS Mini D Ribbon (MDR) Cable
- A Male-to-Micro B Male USB Cable

Note: For testing the MAX7037 EV kit, two sets of above-mentioned packages of EV kits are required; one used as a transmitter and one as a receiver.

[Ordering Information](#) appears at end of data sheet.

Quick Start

Required Equipment and Accessories

- One PC or laptop
- Two A Male-to-Micro-B male USB cables
- Two 14 POS Mini-D Ribbon (MDR) cables
- One SMA cable and several attenuators, total 60dB
- Two MAX7037_315MHz, MAX7037_434MHz, MAX7037_868MHz, or MAX7037_915MHz EV kits
- Two Siam Kitty boards

Jumper Configurations

Shunt J2, J3, J6, J10. J2 has three pins. The two that are shunted are the left-most two pins. J10 also has three pins. The two that are shunted are the top-most two pins. Any jumpers or headers not mentioned here should be left unshunted. [Figure 1](#) shows the location of these jumpers.

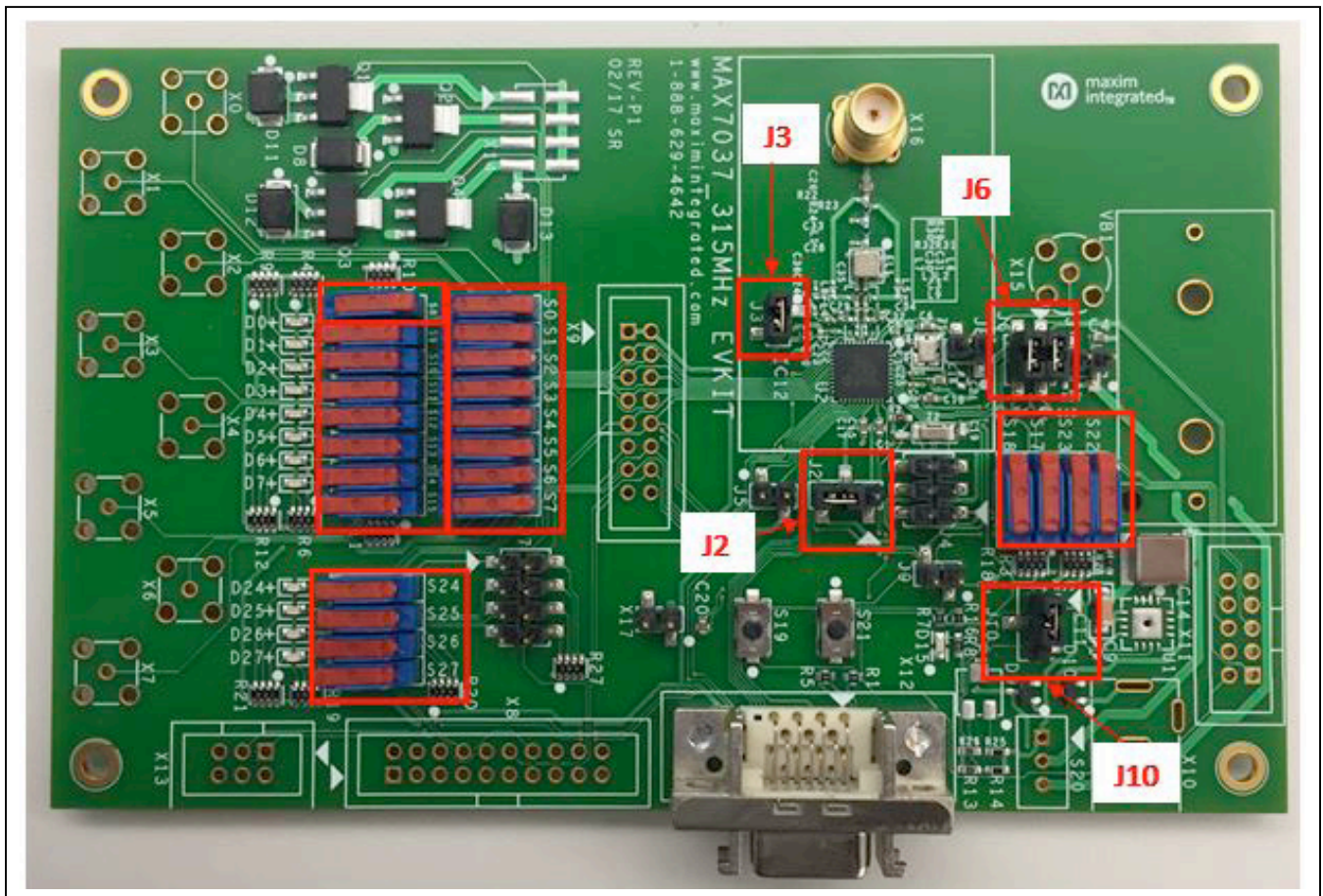

Figure 1. MAX7037 EV Kit Photo Jumpers Location

DIP Switch Settings

Four DIP switches on the EV kit should be configured as described below:

- The four-switch DIP labeled S22, S23, S17, and S18 should all be slid to the upper position, as displayed in [Figure 1](#).
- The four-switch DIP labelled S24–S27 should all be slid to the left position, as shown in [Figure 1](#).
- The 8-switch DIP labelled S0–S7 should all be slid to the right position, as shown in [Figure 1](#).
- The 8-switch DIP labelled S8–S15 should have all but the top-most switch slid to the left, as shown in [Figure 1](#). The top switch of this particular DIP (i.e., the S8 switch) should be slid to the right.

Installing the Host Software

The host software is used to download the firmware to the MAX7037 IC.

Download the *MAX7037host.exe* file from [Maxim](#).

- 1) Save the file to whatever working folder you wish. Note the location of the folder and make sure that the Siam Kitty Board is unplugged during install.
- 2) Download the FTDI drivers from [Maxim](#).
- 3) Extract the drivers and install.
- 4) Connect the first Siam Kitty board to a USB port of the computer and wait at least 30 seconds. If the drivers are installed correctly, the yellow LED in the Siam Kitty board should be illuminated.
- 5) Open a DOS command window and navigate to the directory where the host software is located. For example, if it is in C:\myfolder\MAX7037, then issue the command "cd C:\myfolder\MAX7037".
- 6) In the command window, type "*MAX7037host.exe*" and hit enter. You should see all the options of the command line tool and their descriptions. Type "*MAX7037host.exe -scan*" and hit "Enter". If the device is connected, at the bottom of the screen you will see a line containing the serial number of the first Siam Kitty board, for example "**Device 0: SKZ8TKQZA**". Note the serial number obtained with the scan operation (e.g., "**SKZ8TKQZA**"), and designate this Siam Kitty board as the transmitter.
- 7) Connect the second Siam Kitty board to the same computer and wait at least 30 seconds. Type "*MAX7037host.exe -scan*" and hit enter. If both Siam Kitty boards are connected, you will see a screen that shows two lines containing the serial number of the first and second Siam Kitty boards, for example "**Device 0: SKZ8TKQZA**" and "**Device 1: SKZ8TN4TA**". Note the serial number of the **Device**

1 obtained with scan operation (e.g., "**SKZ8TN4TA**") and designate the second Siam Kitty board as the receiver.

Connections

- 1) Connect the first MAX7037 EV kit, X12 connector, to the first Siam Kitty board (i.e., SKZ8TKQZA) through a Mini-D Ribbon (MDR) cable and consider it to be the transmitter. The power for the EV kit is provided by the Siam Kitty board.
- 2) Connect the second MAX7037 EV kit to the second Siam Kitty Board (i.e., SKZ8TN4TA) and consider it as the receiver.
- 3) Connect an SMA Cable to the Ant SMA connector (X16) of the EV kit designated as the transmitter. Then connect 60dB of attenuation at the other end of the SMA Cable and connect it to the Ant SMA connector (X16) of the EV kit designated as the receiver.

Downloading Firmware

- 1) Download the MAX7037_FW_V1.0.hex firmware binary file from [Maxim](#) to the same folder the *MAX7037host.exe* file was downloaded.
- 2) To program *MAX7037_FW_V1.0.hex* to the MAX7037 IC of the transmitter EV kit, type the command "*MAX7037host.exe -sn SKZ8TKQZA -wprg MAX7037_FW_V1.0.hex*" into the command line interface, then hit "Enter". Note that this is an example. Replace the serial number with the one obtained with the scan operation.
- 3) To program *MAX7037_FW_V1.0.hex* to MAX7037 IC of the receiver EV kit, type the command "*MAX7037host.exe -sn SKZ8TN4TA -wprg MAX7037_FW_V1.0.hex*" into the command line interface, then hit "Enter". Note that this is an example. Replace the serial number with the one obtained with the scan operation.

Downloading TeraTerm Program

This program can be downloaded for free from the [TeraTerm Homepage](#). Since it is known that TeraTerm works well with no issues, it is recommended for use with the MAX7037 EV kit.

- 1) Start TeraTerm. A dialog box will be opened along with a terminal window. Click on the Serial button. Then, click on the pull down menu for Port. At this point, you have to select which COM port to use. Typically, the only way to find this out is by trial-and-error; that is, select each port in turn and see if it works. Once the port is known, it will not change, so it should just be noted. Then, on subsequent startups, you can just directly select the known COM port.

As an example, if COM1 is the first COM port indicated by the TeraTerm New Connection dialog box, select this, and click "OK". Then, in the terminal window, select Setup -> Serial Port... Click on Baud rate, and select 38400. All other serial port parameters should remain as default. The default settings are Data = 8 bit, Parity = none, Stop = 1 bit, Flow Control = none. Click on "OK".

Note: An important point is that the serial link only operates correctly at a baud rate of 38400 bits per second.

- 2) Press the RESET button on the transmitter EV kit and see if the following command prompt appears in the terminal window: **"Welcome to 7037 command line interface, type 'help' for available commands"**. If no text appears, then the correct COM port is not selected, and you have to repeat the procedure with the next COM port in the list. Select Setup -> Serial Port..., then select the next COM port in the Serial Port Setup window. Click OK, then press the EV kit's RESET button. Once you have found the correct COM port, the command prompt will appear.

Note: When starting up the terminal display, it is common to forget to configure the Baud rate (defaults to 9600bps). In this case, when you press the EV kit RESET button, some strange characters will be printed to the display.
- 3) Repeat the whole procedure to find and configure the COM port of the receiver EV kit. Open a second TeraTerm display, and find which COM port it is connected to.
- 4) In the typical usage case, where two EV kits are connected to the same PC, and where one EV kit is designated the transmitter and the other the receiver, it is recommended to put a label on the transmitter and receiver EV kits indicating which is the transmitter and which is the receiver. Make a note of which COM port number corresponds to the transmitter and which to the receiver. Position the two terminal windows on the PC display with transmitter on left and receiver on right just so as to be able to keep track of which is which. It is also possible to change the text at the top of the terminal window to indicate the transmitter or receiver. Select Setup -> Window and type the desired header text into the Title field.

Procedure

The EV kits are configured and controlled via the serial communication port of the MAX7037. The details of the commands are contained in the MAX7037 data sheet, *Communication* section. Refer to that document for detailed information.

- 1) Configure the transmitter EV kit to the desired mode, e.g., FSK, 315MHz, 31.25Kbps operation: On the transmitter terminal window, type the command:

```
>>config_tx_radio 3, for 315MHz, FSK, 31.25Kbps,
>>config_tx_radio 4, for 434MHz, FSK, 31.25Kbps,
>>config_tx_radio 6, for 868MHz, FSK, 31.25Kbps,
>>config_tx_radio 1, for 902MHz, FSK, 31.25Kbps,
>>config_tx_radio 2, for 915MHz, FSK, 125Kbps,
>>config_tx_radio 5, for 928MHz, FSK, 125Kbps,
```

 then press Enter.
- 2) Configure the receiver EV kit to the same mode as transmitter:

On the receiver terminal window, type the command:

```
>>config_rx_radio 3, for 315MHz, FSK, 31.25Kbps,
>>config_rx_radio 4, for 434MHz, FSK, 31.25Kbps,
>>config_rx_radio 6, for 868MHz, FSK, 31.25Kbps,
>>config_rx_radio 1, for 902MHz, FSK, 31.25Kbps,
>>config_rx_radio 2, for 915MHz, FSK, 125Kbps,
>>config_rx_radio 5, for 928MHz, FSK, 125Kbps,
```

 then press enter.
- 3) Load the packet to be used in the test to the transmitter EV kit:

On the transmitter terminal window, type the command: **>>write_tx_pkt 3**, then press Enter.
- 4) Load the packet to be used in the test to the receiver EV kit:

On the receiver terminal window, type the command: **>>write_rx_pkt 3**, then press Enter.
- 5) Reset the BER value of the receiver EV kit:

On the receiver terminal window, type the command: **>>reset_ber**, then press Enter.
- 6) Enable BER measurement at the receiver EV kit:

On the receiver terminal window, type the command: **>>ber_enable**, then press Enter.
- 7) Set the interval of the transmitter EV kit:

On the transmitter terminal window, type the command: **>>tx_interval 20**, then press Enter.
- 8) Configure transmitter EV kit to transmit the packet continuously:

On the transmitter terminal window, type the command: **>>send_pkt 0**, then hit enter. Once you press **Enter**, the **D0 LED** (located beside the S8 switch of the 8-switch DIP labelled S8–S15) on the transmitter EV kit will start blinking.

- 9) Configure receiver EV kit to receive packets:
On the receiver terminal window, type the command:
>>rx_pkt_start, then hit enter. Once you press Enter, the **D0 LED** on the receiver EV kit also will start blinking.
- 10) Run the test until at least 100,000 bits have been received. For this purpose, the test should be run for at least 42 seconds. You can monitor the current Bit Error Rate (BER) value, and how many bits have been transmitted, by issuing command **>>read_ber**, on the receiver terminal window. When you type the command, you may not see the command on the terminal window. In such a case, type the command and press Enter. If you mistype, you will receive the “not a valid cmd”, then, retype the command and press Enter.
- 11) After 100,000 bits have been received, stop transmission at transmitter EV kit:
On the transmitter terminal window, type the command:
>>q, then press Enter. Once you press Enter, the **D0 LEDs** on the transmitter and receiver EV kits will stop blinking.
- 12) Stop reception at receiver EV kit:
On the receiver terminal window, type the command:
>>rx_pkt_stop, then press Enter. The numerator of the BER value should be 0.

- 13) Reset both EV kits by pressing the RESET button on the EV kit.
- 14) Swap the role of transmit and receive EV kits by designating the transmitter terminal window as receiver and vice versa. Then repeat the above procedure from step 1.

Note that this procedure is testing two EV kits at a time. In the first pass, the transmit functionality of one EV kit and the receive functionality of the other EV kit is being tested. In the second pass, the roles of transmitter and receiver are reversed. This two-pass procedure provides test coverage of both transmit and receive functionality of both EV kits.

Changing EV Kit for Operation at Other Frequencies

In order to change the operating frequency of an EV kit, it is necessary to install the correct RF matching components between the IC and the antenna SMA connector. EV kits are shipped from Maxim with the components corresponding to the 315MHz, 434MHz, 868MHz, or 915MHz frequencies. Refer to [Table 1](#) to determine how to modify the RF front-end circuitry to allow operation at other frequencies.

Table 1. RF Matching Components

RF MATCHING COMPONENTS TO CONFIGURE AN EV KIT TO WORK AT ONE OF THE BELOW FREQUENCIES				
COMPONENT				
FREQUENCY (MHz)	315	434	868	902/915/928
SAW Filter/Balun Option	SAW Filter	SAW Filter	SAW Filter	Balun
R24/R29/R30	0Ω	0Ω	0Ω	OPEN
R22/R23/R31/R32	OPEN	OPEN	OPEN	0Ω
C30/C31	220pF	220pF	8.2pF	OPEN
L2/L3	33nH	27nH	8.2nH	OPEN
FL1	B3741	B3743	B3744	OPEN
L1	68nH	47nH	22nH	OPEN
L4	120nH	100nH	100nH	100nH
C33	OPEN	OPEN	2.7pF	OPEN
C34/C35	OPEN	OPEN	OPEN	1.8pF
L5/L6/L7/L8/L9	OPEN	OPEN	OPEN	18nH
C3	OPEN	OPEN	OPEN	1.5pF
C36	OPEN	OPEN	OPEN	220pF

Component Suppliers

SUPPLIER	WEBSITE
Murata	http://www.murata.com/
TDK	http://www.tdk.com/
Taiyo Yuden	http://www.t-yuden.com/
Vishay	http://www.vishay.com/
Lite-On Inc.	http://www.us.liteon.com/
Diodes Incorporated	http://www.diodes.com/
Broadcom Limited (Avago)	http://www.avagotech.com/
EPCOS (TDK)	http://en.tdk.eu/
Samtec Inc.	https://www.samtec.com/
Apem Inc.	http://www.apem.com/
C&K Component	http://www.ck-components.com/
3M	http://www.3m.com/
Johnson	http://www.cinch.com/
NDK (Nihon Dempa Kogyo Co)	http://www.ndk.com/
TXC Corporation	http://www.txccrystal.com/
KEMET	http://www.kemet.com/
Panasonic Electronic Components	https://na.industrial.panasonic.com/
Sullins Connector Solutions	http://www.sullinscorp.com/

MAX7037_315MHz EV Kit Bill of Materials

Item	Reference	Qty	Value	Tolerance	Description	Part Number	Manufacturer
1	C1, C19	2	10pF	±10%	0603 CERAMIC CAPACITOR, SMT	C0603C100K1GAC	KEMET
2	C2, C13	2	100pF	±5%	0603 CERAMIC CAPACITOR, SMT	C0603C101J5GAC/ GRM1885C1H101JA01	KEMET/ MURATA
3	C3, C9, C21, C28, C33-C35, C36	8	Do not install				
4	C4, C6, C10, C12, C15-C18, C20	9	0.1µF	±10%	0603 CERAMIC CAPACITOR, SMT	GRM188R72A104KA35/CO0603KRX7R0BB104	MURATA/TKD
9	C5, C22, C25, C27, C29, C30, C31, C32	10	220pF	±10%	0402 CERAMIC CAPACITOR, SMT	GRM15BR71H2Z1KA01	MURATA
5	C7, C8	2	10pF	±5%	0402 CERAMIC CAPACITOR, SMT	C0402C100J5GAC, GRM1555C1H100JA01	KEMET/ MURATA
6	C11	1	22µF	±10%	1206 CERAMIC CAPACITOR, SMT	GRM31CR70J226K	MURATA
7	C14	1	47µF	±20%	2220 CERAMIC CAPACITOR, SMT	C5750XTR1C476M230KB	TDK
8	C26	1	820pF	±10%	0603 CERAMIC CAPACITOR, SMT	GRM188R71H2Z1KA01	MURATA
10	D0-D7, D24-D27	12	L1TST-C190KRKT		DIODE, LED, ULTRA BRIGHT AlInGaP CHIP LED, RED, SMT, VF=2V, IF=0.025A	L1TST-C190KRKT	LITE-ON ELECTRONICS, INC.
11	D8, D11-D13	4	36V		DIODE, TVS, SMB (DO-21AAA), VRM=36V, IPP=10.3A	SMBJ36A-E3	VISHAY GENERAL SEMICONDUCTOR
12	D9, D10	2	BAS16-Z-F		DIODE, SMT, SMT (SOT23), PIV=75V, IF=0.3A	BAS16-Z-F	DIODES INCORPORATED
13	D15	1	HSMG-C190		DIODE, LED, SURFACE MOUNT CHIP LED, GREEN, SMT (0603), PIV=2.2V, IF=0.02A	HSMG-C190	AVAGO TECHNOLOGIES
14	FL1	1	315.0MHz		FILTER, SAW, B3741 SERIES, SMT, 315.0MHz	B38321B3741HT10	TDK
15	J1, J3, J5, J8, J9, X17	6	TSM-102-01-L-SV		CONNECTOR, MALE, SMT, SINGLE ROW, STRAIGHT THROUGH, 2PINS	TSM-102-01-L-SV	SAMTEC
16	J2, J10	2	TSM-103-01-T-SV		CONNECTOR, MALE, SMT, TSM SERIES, STRAIGHT, 3PINS	TSM-103-01-T-SV	SAMTEC
17	J4	1	TSM-103-01-T-DV		CONNECTOR, MALE, SMT, SMT, 025IN SQ POST HEADER, STRAIGHT, 6PINS	TSM-103-01-T-DV	SAMTEC
18	J6	1	TSM-102-01-T-DV		CONNECTOR, MALE, SMT, 025IN SQ POST HEADER, STRAIGHT, 4PINS	TSM-102-01-T-DV	SAMTEC
19	J7	1	TSM-104-01-L-DV		CONNECTOR, MALE, SMT, SMT, 025IN SQ POST HEADER, STRAIGHT, 8PINS	TSM-104-01-L-DV	SAMTEC
20	L1	1	68µH	±2%	0402 WIREWOUND INDUCTOR, SMT	LMV1EA68NG00	MURATA
21	L2, L3	2	33µH	±5%	0402 CERAMIC INDUCTOR, SMT	HK1005S3NJ	TAIYO YUDEN
22	L4	1	120µH	±5%	0402 CERAMIC INDUCTOR, SMT	HK1005R1ZJ	TAIYO YUDEN
23	L5-L9	5	Do not install				
24	Q1-Q4	4	ZXMS6006DGT		TRAN, 60V N-CANNEL SELF PROTECTED ENHANCEMENT MODE INTELLIFET MOSFET, NCH, SOT223-4, PD-(GW), L-(2.8A), V-(60V)	ZXMS6006DGT	DIODES INCORPORATED
25	R1, R7, R18	3	10K OHM	±1%	0603 THICK FILM RESISTOR, 0.10W	GRCW060310K0FK/ERJ-3EKF1002	VISHAY DALE/PANASONIC
26	R2	1	1M OHM	±1%	0603 THICK FILM RESISTOR, 0.10W	GRCW06031M00FK/MCRO3EZFHX1004	VISHAY DALE/ROHM
27	R3	1	10K OHM	±5%	1206 ARRAY RESISTOR, SMT, 0.063W	GRA06P08310K0J	VISHAY DALE
28	R4, R6, R10, R11, R15, R19, R20, R27	8	100K OHM	±5%	1206 ARRAY RESISTOR, SMT, 0.063W	GRA06P083100KJ	VISHAY DALE
29	R5	1	100 OHM	±1%	0603 THICK FILM RESISTOR, 0.10W	GRCW0603100RFK/ERJ-3EKF1000	VISHAY DALE/PANASONIC
30	R8	1	270 OHM	±1%	0603 THICK FILM RESISTOR, 0.10W	GRCW0603270RFK	VISHAY DALE
31	R9, R12, R21	3	330 OHM	±5%	1206 ARRAY RESISTOR, SMT, 0.063W	GRA06P083330FJ	VISHAY DALE
32	R13, R26	2	33K OHM	±1%	0603 THICK FILM RESISTOR, 0.10W	GRCW060333K0FK	VISHAY DALE
33	R14, R25	2	56K OHM	±1%	0603 THICK FILM RESISTOR, 0.10W	GRCW060356K0FK	VISHAY DALE
34	R16	1	0 OHM	0%	0603 THICK FILM RESISTOR, 0.25W	GRCW0603000Z0EAHP	VISHAY DRALORIC
35	R17, R22-R23, R31-R32	5	Do not install		JUMPER		
36	R24, R29, R30	3	0 OHM	0%	0402 THICK FILM RESISTOR, 0.10W	ERJ-2GE0R00X	PANASONIC
37	R28	1	1.8M OHM	±1%	0603 THICK FILM RESISTOR, 0.10W	GRCW06031M80FK	VISHAY DALE
38	P1	1	Do not install				
39	S0-S15, S17, S18, S22-S27	24	NK236		SWITCH, SPDT, THROUGH HOLE, 12V, 0.5A, NK SERIES, RCOIL=OHM, INSULATION=OHM, APEM	NK236	APEM
40	S19, S21	2	KSR211GLFS		SWITCH, SPST, 32V, 0.05A, SUBMINIATURE TACT SWITCH, RCOIL=10G OHM	KSR211GLFS	C&K COMPONENTS
41	S20	1	Do not install				
42	SH1-SH6	6	STC02SYAN		TEST POINT; JUMPER; STR; TOTAL LENGTH=0.256IN; BLACK; INSULATION=PBT CONTACT=PHOSPHOR BRONZE; COPPER PLATED TIN OVERALL	STC02SYAN	SULLINS ELECTRONICS CORP.
43	U1	1	Do not install				

MAX7037_315MHz EV Kit Bill of Materials (continued)

Item	Reference	Qty	Value	Tolerance	Description	Part Number	Manufacturer
44	U2	1	MAX7037EGL+		EVKIT PART-IC; TXRX; SUB-1GHz; ULTRA LOW POWER; RF ISM TRANSCEIVER FOR CUSTOMER/INDUSTRIAL APPLICATION; TOFN40-EP 6X6	MAX7037EGL+	MAXIM
45	VBI	1	Do not install				
46	XG-X11, X13-X15	15	Do not install				
47	X12	1	N10214-5212PC		CONNECTOR; FEMALE; THROUGH HOLE; MINI D RIBBON; RIGHT ANGLE; 14PINS	N10214-5212PC	3M ELECTRONIC SOLUTIONS DIVISION
48	X16	1	142-0701-201		CONNECTOR; FEMALE THREADED; THROUGH HOLE; SMA; STRAIGHT THROUGH; 5PINS	142-0701-201	JOHNSON COMPONENTS
49	Z1	1	16MHZ		CRYSTAL; SMT 2.5MMX2MM; 8PF; 16MHZ; +/-10PPM; +/-10PPM	NX2520SA-16MHZ-STD-6SX-1	NIHON DENPA KOGYO CO
50	Z2	1	32.768KHZ		CRYSTAL; SMT 3.2MMX1.5MM; 12.5PF; 32.768KHZ; +/-20PPM	9HT10-32.768KEZF-T	TXC CORPORATION
51	PCB	1	PCB		PCB:MAX7037315MHZ	MAX7037315MHZ	MAXIM
TOTAL		169					

MAX7037_434MHz EV Kit Bill of Materials

Item	Reference	Qty	Value	Tolerance	Description	Part Number	Manufacturer
1	C1, C19	2	10pF	±10%	0603 CERAMIC CAPACITOR, SMT	C0603C100K1GAC	KEMET
2	C2, C13	2	100pF	±5%	0603 CERAMIC CAPACITOR, SMT	C0603C101J5GAC7 GRM1885C1H101JA01	KEMET/ MURATA
3	C3, C9, C21, C28, C33, C35, C36	8	Do not install				
4	C4, C6, C10, C12, C15-C18, C20	9	0.1µF	±10%	0603 CERAMIC CAPACITOR, SMT	GRM188R72A104KA35/ CC0603KRX7R0BB104	MURATA/ TDK
9	C5, C22-C25, C27, C29, C30, C31, C32	10	220pF	±10%	0402 CERAMIC CAPACITOR, SMT	GRM155R71H2Z1KA01	MURATA
5	C7, C8	2	10pF	±5%	0402 CERAMIC CAPACITOR, SMT	C0402C100J5GAC;	KEMET/
6	C11	1	22µF	±10%	1206 CERAMIC CAPACITOR, SMT	GRM1555C1H100JA01	MURATA
7	C14	1	47µF	±20%	2220 CERAMIC CAPACITOR, SMT	GRM31GR70J226K	MURATA
8	C16	1	820pF	±10%	0603 CERAMIC CAPACITOR, SMT	C5750X7R1C476M230KB	TDK
10	D0-D7, D24-D27	12	LTST-C190KRKT		DIODE: LED; ULTRA BRIGHT AlInCap CHIP LED; RED; SMT; VF=2V; IF=0.025A	LTST-C190KRKT	LITE-ON ELECTRONICS; INC.
11	D8, D11-D13	4	36V		DIODE: TVS; SMB (DO-214AA); VRM=36V; IPP=10.3A	SMBJ36A-E3	VISHAY GENERAL SEMICONDUCTOR
12	D9, D10	2	BAS16-7-F		DIODE: SWT; SMT (SOT-23); PIV=75V; IF=0.3A	BAS16-7-F	DIODES INCORPORATED
13	D15	1	HSMG-C190		DIODE: LED; SURFACE MOUNT CHIP LED; GREEN; SMT (0603); PIV=2.2V; IF=0.02A	HSMG-C190	AVAGO TECHNOLOGIES
14	FL1	1	433.92MHZ		FILTER; SAW; B3743 SERIES; SMT; 433.92MHZ	B39431B3743H110	TDK
15	J1, J3, J5, J8, J9, X17	6	TSM-102-01-L-SV		CONNECTOR: MALE; SMT; SINGLE ROW; STRAIGHT THROUGH; 2PINS	TSM-102-01-L-SV	SAMTEC
16	J2, J10	2	TSM-103-01-T-SV		CONNECTOR: MALE; SMT; TSM SERIES; STRAIGHT; 3PINS	TSM-103-01-T-SV	SAMTEC
17	J4	1	TSM-103-01-T-DV		CONNECTOR: MALE; SMT; SMT .025IN SQ POST HEADER; STRAIGHT; 6PINS	TSM-103-01-T-DV	SAMTEC
18	J6	1	TSM-102-01-T-DV		CONNECTOR: MALE; SMT; .025IN SQ POST HEADER; STRAIGHT; 4PINS	TSM-102-01-T-DV	SAMTEC
19	J7	1	TSM-104-01-L-DV		CONNECTOR: MALE; SMT; SMT .025IN SQ POST HEADER; STRAIGHT; 8PINS	TSM-104-01-L-DV	SAMTEC
20	L1	1	47nH	±2%	0402 WIREWOUND INDUCTOR, SMT	LQW15AN47NG00	MURATA
21	L2, L3	2	27nH	±5%	0402 CERAMIC INDUCTOR, SMT	HK100527NJ	TAIYO YUDEN
22	L4	1	100nH	±5%	0402 CERAMIC INDUCTOR, SMT	HK1005R10J	TAIYO YUDEN
23	L5-L9	5	Do not install				
24	Q1-Q4	4	ZXMS6006DGTA		TRAN; 60V N-CHANNEL SELF PROTECTED ENHANCEMENT MODE INTELLIFET MOSFET; NCH; SOT223-4; PD-(3W); I-(2.8A); V-(60V)	ZXMS6006DGTA	DIODES INCORPORATED
25	R1, R7, R18	3	10K OHM	±1%	0603 THICK FILM RESISTOR, 0.10W	CRCW060310K0FK/ ERJ-3EKF1002	VISHAY DALE/ PANASONIC
26	R2	1	1M OHM	±1%	0603 THICK FILM RESISTOR, 0.10W	CRCW06031M00FK;	VISHAY DALE/ ROHM
27	R3	1	10K OHM	±5%	1206 ARRAY RESISTOR, SMT, 0.063W	MCR03EZPFX1004 CRA06P08310K0J	VISHAY DALE
28	R4, R6, R10, R11, R15, R19, R20, R27	8	100K OHM	±5%	1206 ARRAY RESISTOR, SMT, 0.063W	CRA06P083100KJ	VISHAY DALE
29	R5	1	100 OHM	±1%	0603 THICK FILM RESISTOR, 0.10W	CRCW0603100RFK/ ERJ-3EKF1000	VISHAY DALE/ PANASONIC

MAX7037_434MHz EV Kit Bill of Materials (continued)

Item	Reference	Qty	Value	Tolerance	Description	Part Number	Manufacturer
30	R8	1	270 OHM	±1%	0603 THICK FILM RESISTOR, 0.10W	CRCW06032700FK	VISHAY DALE
31	R9, R12, R21	3	330 OHM	±5%	1206 ARRAY RESISTOR, SMT, 0.063W	CRA06P083330RJ	VISHAY DALE
32	R13, R26	2	33K OHM	±1%	0603 THICK FILM RESISTOR, 0.10W	CRCW060333K0FK	VISHAY DALE
33	R14, R25	2	56K OHM	±1%	0603 THICK FILM RESISTOR, 0.10W	CRCW060356K0FK	VISHAY DALE
34	R16	1	0 OHM	0%	0603 THICK FILM RESISTOR, 0.25W	CRCW06030000Z0EAHP	VISHAY DRALORIC
35	R17, R22-R23, R31-R32	5	Do not install	JUMPER			
36	R24, R29, R30	3	0 OHM	0%	0402 THICK FILM RESISTOR, 0.10W	ERJ-2GE0R00X	PANASONIC
37	R28	1	1.8M OHM	±1%	0603 THICK FILM RESISTOR, 0.10W	CRCW06031M80FK	VISHAY DALE
38	P1	1	Do not install				
39	S0-S15, S17, S18, S22-S27	24	NK236		SWITCH, SPDT; THROUGH HOLE; 12V, 0.5A; NK SERIES; RCOIL= OHM; RINSULATION= OHM; APEM	NK236	APEM
40	S19, S21	2	KSR211GLFS		SWITCH, SPST, 32V, 0.05A, SUBMINIATURE TACT SWITCH, RCOIL=10G OHM	KSR211GLFS	C&K COMPONENTS
41	S20	1	Do not install				
42	SH1-SH6	6	STC02SYAN		TEST POINT; JUMPER; STR; TOTAL LENGTH=0.256IN; BLACK; INSULATION=PBT CONTACT=PHOSPHOR BRONZE; COPPER PLATED TIN OVERALL	STC02SYAN	SULLINS ELECTRONICS CORP.
43	U1	1	Do not install				
44	U2	1	MAX7037EGL+		EVKIT PART-IC; TXRX; SUB-1GHZ; ULTRA LOW POWER; RF ISM TRANSCIEVER FOR CUSTOMER/INDUSTRIAL APPLICATION; TQFN40-EP 6X6	MAX7037EGL+	MAXIM
45	VB1	1	Do not install				
46	X0-X11, X13-X15	15	Do not install				
47	X12	1	N10214-5212PC		CONNECTOR; FEMALE; THROUGH HOLE; MINI D RIBBON; RIGHT ANGLE; 14PINS	N10214-5212PC	3M ELECTRONIC SOLUTIONS DIVISION
48	X16	1	142-0701-201		CONNECTOR; FEMALE THREADED; THROUGH HOLE; SMA; STRAIGHT THROUGH; 5PINS	142-0701-201	JOHNSON COMPONENTS
49	Z1	1	16MHZ		CRYSTAL; SMT 2.5MMX2MM; 8PF; 16MHZ; +/-10PPM; +/-10PPM	NX2520SA-16MHZ-STD-CSX-1	NIHON DEMPYA KOGYO CO
50	Z2	1	32.768KHZ		CRYSTAL; SMT 3.2MMX1.5MM; 12.5PF; 32.768KHZ; +/-20PPM	9HT10-32.768KEZF-T	TXC CORPORATION
51	PCB	1	PCB		PCB:MAX7037434MHZ	MAX7037434MHZ	MAXIM
TOTAL		169					

MAX7037_868MHz EV Kit Bill of Materials

Item	Reference	Qty	Value	Tolerance	Description	Part Number	Manufacturer
1	C1, C19	2	10pF	±10%	0603 CERAMIC CAPACITOR, SMT	C0603C100K1GAC	KEMET
2	C2, C13	2	100pF	±5%	0603 CERAMIC CAPACITOR, SMT	C0603C101J5GAC/ GRM1885C1H101JA01	KEMET/ MURATA
3	C3, C9, C21, C28, C34-C35, C36	7	Do not install				
4	C4, C6, C10, C12, C15-C18, C20	9	0.1µF	±10%	0603 CERAMIC CAPACITOR, SMT	GRM188R72A104KA35/ C06003KRX7R0BB104	MURATA/ TDK
5	C5, C22-C25, C27, C29, C32	8	220pF	±10%	0402 CERAMIC CAPACITOR, SMT	GRM155R71H221KA01	MURATA
6	C7, C8	2	10pF	±5%	0402 CERAMIC CAPACITOR, SMT	C0402C100J5GAC/ GRM1555C1H100JA01	KEMET/ MURATA
7	C11	1	22µF	±10%	1206 CERAMIC CAPACITOR, SMT	GRM31GR70J226K	MURATA
8	C14	1	47µF	±20%	2220 CERAMIC CAPACITOR, SMT	C5750X7R1C476M230KB	TDK
9	C26	1	820pF	±10%	0603 CERAMIC CAPACITOR, SMT	GRM188R71H821KA01	MURATA
10	C30, C31	2	8.2pF	±0.25pF	0402 CERAMIC CAPACITOR, SMT	GRM1555C1H8R2CA01	MURATA
11	C33	1	2.7pF	±0.25pF	0402 CERAMIC CAPACITOR, SMT	GRM1555C1H2R7CA01	MURATA
12	D0-D7, D24-D27	12	LTST-C190KRKT		DIODE; LED; ULTRA BRIGHT AlnCap CHIP LED; RED; SMT; VF=2V; IF=0.025A	LTST-C190KRKT	LITE-ON ELECTRONICS; INC.
13	D8, D11-D13	4	36V		DIODE; TVS; SMB (DO-214AA); VRM=36V; IPP=10.3A	SMBJ36A-E3	VISHAY GENERAL SEMICONDUCTOR
14	D9, D10	2	BA516-7-F		DIODE; SMT; SMT (SOT-23); PIV=75V; IF=0.3A	BA516-7-F	DIODES INCORPORATED
15	D15	1	HSMG-C190		DIODE; LED; SURFACE MOUNT CHIP LED; GREEN; SMT (0603); PIV=2.2V; IF=0.02A	HSMG-C190	AVAGO TECHNOLOGIES
16	FL1	1	868.30MHZ		FILTER; SAW; B3744 SERIES; SMT; 868.30MHZ	B39871B3744H110	TDK
17	J1, J3, J5, J8, J9, X17	6	TSM-102-01-L-SV		CONNECTOR; MALE; SMT; SINGLE ROW; STRAIGHT THROUGH; 2PINS	TSM-102-01-L-SV	SAMTEC
18	J2, J10	2	TSM-103-01-T-SV		CONNECTOR; MALE; SMT; TSM SERIES; STRAIGHT; 3PINS	TSM-103-01-T-SV	SAMTEC
19	J4	1	TSM-103-01-T-DV		CONNECTOR; MALE; SMT; .025IN SQ POST HEADER; STRAIGHT; 6PINS	TSM-103-01-T-DV	SAMTEC
20	J6	1	TSM-102-01-T-DV		CONNECTOR; MALE; SMT; .025IN SQ POST HEADER; STRAIGHT; 4PINS	TSM-102-01-T-DV	SAMTEC
21	J7	1	TSM-104-01-L-DV		CONNECTOR; MALE; SMT; SMT; .025IN SQ POST HEADER; STRAIGHT; 8PINS	TSM-104-01-L-DV	SAMTEC
22	L1	1	22nH	±2%	0402 WIREWOUND INDUCTOR, SMT	LQW15AN22NG00	MURATA
23	L2, L3	2	8.2nH	±2%	0402 WIREWOUND INDUCTOR, SMT	LQW15AN82NG00	MURATA
24	L4	1	100nH	±5%	0402 CERAMIC INDUCTOR, SMT	HK1005R10J	TAIYO YUDEN
25	L5-L9	5	Do not install				
26	Q1-Q4	4	ZXMS6006DGTA		TRAN; 60V N-CHANNEL SELF PROTECTED ENHANCEMENT MODE INTELLIFET MOSFET; NCH; SOT223-4; PD-(3W); I-(2.8A); V-(60V)	ZXMS6006DGTA	DIODES INCORPORATED
27	R1, R7, R18	3	10K OHM	±1%	0603 THICK FILM RESISTOR, 0.10W	CRCW060310K0FFK/ ERJ-3EKF1002	VISHAY DALE/ PANASONIC
28	R2	1	1M OHM	±1%	0603 THICK FILM RESISTOR, 0.10W	CRCW06031M00FFK/ MCR03EZPPX1004	VISHAY DALE/ ROHM
29	R3	1	10K OHM	±5%	1206 ARRAY RESISTOR, SMT, 0.063W	CRA06P08310KJ	VISHAY DALE
30	R4, R6, R10, R11, R15, R19, R20, R27	8	100K OHM	±5%	1206 ARRAY RESISTOR, SMT, 0.063W	CRA06P083100KJ	VISHAY DALE
31	R5	1	100 OHM	±1%	0603 THICK FILM RESISTOR, 0.10W	CRCW0603100RFFK/ ERJ-3EKF1000	VISHAY DALE/ PANASONIC
32	R8	1	270 OHM	±1%	0603 THICK FILM RESISTOR, 0.10W	CRCW0603270RFFK	VISHAY DALE

MAX7037_868MHz EV Kit Bill of Materials (continued)

Item	Reference	Qty	Value	Tolerance	Description	Part Number	Manufacturer
33	R9, R12, R21	3	330 OHM	±5%	1206 ARRAY RESISTOR, SMT, 0.063W	CRA06P083330R0J	VISHAY DALE
34	R13, R26	2	33K OHM	±1%	0603 THICK FILM RESISTOR, 0.10W	CRCW060333K0FK	VISHAY DALE
35	R14, R25	2	56K OHM	±1%	0603 THICK FILM RESISTOR, 0.10W	CRCW060356K0FK	VISHAY DALE
36	R16	1	0 OHM	0%	0603 THICK FILM RESISTOR, 0.25W	CRCW060300020EAHP	VISHAY DRALORIC
37	R17, R22, R23, R31+R32	5	Do not install				
38	R24, R29, R30	3	0 OHM	0%	0402 THICK FILM RESISTOR, 0.10W	ERJ-2GE0R00X	PANASONIC
39	R28	1	1.8M OHM	±1%	0603 THICK FILM RESISTOR, 0.10W	CRCW06031M80FK	VISHAY DALE
40	P1	1	Do not install				
41	S0-S15, S17, S18, S22-S27	24	NK236		SWITCH; SPDT; THROUGH HOLE; 12V; 0.5A; NK SERIES; RCOIL= OHM; RINSULATION= OHM; APEM	NK236	APEM
42	S19, S21	2	KSR211GLFS		SWITCH, SPST, 32V, 0.05A, SUBMINIATURE TACT	KSR211GLFS	C&K COMPONENTS
43	S20	1	Do not install				
44	SH1-SH6	6	STC02SYAN		TEST POINT; JUMPER; STR; TOTAL LENGTH=0.256IN; BLACK; INSULATION=PBT CONTACT=PHOSPHOR BRONZE; COPPER PLATED TIN OVERALL	STC02SYAN	SULLINS ELECTRONICS CORP.
45	U1	1	Do not install				
46	U2	1	MAX7037EGL+		EVKIT PART-IC; TXRX; SUB-1GHZ; ULTRA LOW POWER; RF ISM TRANSCEIVER FOR CUSTOMER/INDUSTRIAL APPLICATION; TOFN40-EP 6X6	MAX7037EGL+	MAXIM
47	VB1	1	Do not install				
48	X0-X11, X13-X15	15	Do not install				
49	X12	1	N10214-5212PC		CONNECTOR; FEMALE; THROUGH HOLE; MINI D RIBBON; RIGHT ANGLE; 14PINS	N10214-5212PC	3M ELECTRONIC SOLUTIONS DIVISION
50	X16	1	142-0701-201		CONNECTOR; FEMALE THREADED; THROUGH HOLE; SMA; STRAIGHT THROUGH; 5PINS	142-0701-201	JOHNSON COMPONENTS
51	Z1	1	16MHZ		CRYSTAL; SMT 2.5MMX2MM; 8PF; 16MHZ; +/-10PPM	NX2520SA-16MHZ-STD-CSX-1	NIHON DENPA KOGYO CO
52	Z2	1	32.768KHZ		CRYSTAL; SMT 3.2MMX1.5MM; 12.5PF; 32.768KHZ; +/-20PPM	9HT10-32.768KHZF-T	TXC CORPORATION
53	PCB	1	PCB		PCB:MAX7037868MHZ	MAX7037868MHZ	MAXIM
TOTAL		169					

MAX7037_915MHz EV Kit Bill of Materials

Item	Reference	Qty	Value	Tolerance	Description	Part Number	Manufacturer
1	C1, C19	2	10pF	±10%	0603 CERAMIC CAPACITOR, SMT	C0603C100K1GAC	KEMET
2	C2, C13	2	100pF	±5%	0603 CERAMIC CAPACITOR, SMT	C0603C101J5GAC/ GRM1885C1H101JA01	KEMET/ MURATA
3	C3	1	1.5pF	±0.1pF	0402 CERAMIC CAPACITOR, SMT	GRM1555C1H1R5BA01	MURATA
4	C4, C6, C10, C12, C15-C18, C20	9	0.1µF	±10%	0603 CERAMIC CAPACITOR, SMT	GRM188R72A104KA35/ CC0603KRX7R0BB104	MURATA/ TDK
5	C5, C22-C25, C27, C29, C32, C36	9	220pF	±10%	0402 CERAMIC CAPACITOR, SMT	GRM155R71H221KA01	MURATA
6	C7, C8	2	10pF	±5%	0402 CERAMIC CAPACITOR, SMT	C0402C100J5GAC/ GRM1555C1H100JA01	KEMET/ MURATA
7	C9, C21, C28, C30-C31, C33	6	Do not install				
8	C11	1	22µF	±10%	1206 CERAMIC CAPACITOR, SMT	GRM31CR70J226K	MURATA
9	C14	1	47µF	±20%	2220 CERAMIC CAPACITOR, SMT	C5750X7R1C476M230XB	TDK
10	C26	1	820pF	±10%	0603 CERAMIC CAPACITOR, SMT	GRM188R71H821KA01	MURATA
11	C34, C35	2	1.8pF	±0.1pF	0402 CERAMIC CAPACITOR, SMT	GRM1555C1H1R8BA01	MURATA
12	D0-D7, D24-D27	12	LTST-C190KRKT		DIODE: LED; ULTRA BRIGHT AlInGaP CHIP LED; RED; SMT; VF=2V; IF=0.025A	LTST-C190KRKT	LITE-ON ELECTRONICS; INC.
13	D8, D11-D13	4	36V		DIODE; TVS; SMB (DO-214AA); VIRM=36V; IPP=10.3A	SMBJ36A-E3	VISHAY GENERAL SEMICONDUCTOR
14	D9, D10	2	BAS16-7-F		DIODE: SMT; SMT (SOT-23); PIV=75V; IF=0.3A	BAS16-7-F	DIODES INCORPORATED
15	D15	1	HSMG-C190		DIODE; LED; SURFACE MOUNT CHIP LED; GREEN; SMT (0603); PIV=2.2V; IF=0.02A	HSMG-C190	AVAGO TECHNOLOGIES
16	J1, J3, J5, J8, J9, X17	6	TSM-102-01-L-SV		CONNECTOR; MALE; SMT; SINGLE ROW; STRAIGHT THROUGH; 2PINS	TSM-102-01-L-SV	SAMTEC
17	J2, J10	2	TSM-103-01-T-SV		CONNECTOR; MALE; SMT; TSM SERIES; STRAIGHT; 3PINS	TSM-103-01-T-SV	SAMTEC
18	J4	1	TSM-103-01-T-DV		CONNECTOR; MALE; SMT; SMT .025IN SQ POST HEADER; STRAIGHT; 6PINS	TSM-103-01-T-DV	SAMTEC
19	J6	1	TSM-102-01-T-DV		CONNECTOR; MALE; SMT; .025IN SQ POST HEADER; STRAIGHT; 4PINS	TSM-102-01-T-DV	SAMTEC
20	J7	1	TSM-104-01-L-DV		CONNECTOR; MALE; SMT; SMT .025IN SQ POST HEADER; STRAIGHT; 8PINS	TSM-104-01-L-DV	SAMTEC
21	L1, L2-L3	3	Do not install				
22	L4	1	100nH	±5%	0402 CERAMIC INDUCTOR, SMT	HK1005R10J	TAIYO YUDEN
23	L5-L9	5	18nH	±5%	0402 CERAMIC INDUCTOR, SMT	HK100518NJ	TAIYO YUDEN
24	Q1-Q4	4	ZXMS6006DGTA		TRAN; 60V N-CHANNEL SELF PROTECTED ENHANCEMENT MODE INTELLIFET MOSFET; NCH; SOT223-4; PD-(3W); L-(2.8A); V-(60V)	ZXMS6006DGTA	DIODES INCORPORATED
25	R1, R7, R18	3	10K OHM	±1%	0603 THICK FILM RESISTOR; 0.10W	CRCW060310K0FK/ ERJ-3EKF1002	VISHAY DALE/ PANASONIC
26	R2	1	1M OHM	±1%	0603 THICK FILM RESISTOR; 0.10W	CRCW06031M00FK/ MCR03EZPFX1004	VISHAY DALE/ ROHM
27	R3	1	10K OHM	±5%	1206 ARRAY RESISTOR, SMT, 0.063W	CRA06P08310KJ	VISHAY DALE
28	R4, R6, R10, R11, R15, R19, R20, R27	8	100K OHM	±5%	1206 ARRAY RESISTOR, SMT, 0.063W	CRA06P083100KJ	VISHAY DALE
29	R5	1	100 OHM	±1%	0603 THICK FILM RESISTOR; 0.10W	CRCW0603100RFK/ ERJ-3EKF1000	VISHAY DALE/ PANASONIC
30	R8	1	270 OHM	±1%	0603 THICK FILM RESISTOR; 0.10W	CRCW0603270RFK	VISHAY DALE
31	R9, R12, R21	3	330 OHM	±5%	1206 ARRAY RESISTOR, SMT, 0.063W	CRA06P083330RJ	VISHAY DALE

MAX7037_915MHz EV Kit Bill of Materials (continued)

Item	Reference	Qty	Value	Tolerance	Description	Part Number	Manufacturer
32	R13, R26	2	33K OHM	±1%	0603 THICK FILM RESISTOR, 0.10W	GRCW060333K0FK	VISHAY DALE
33	R14, R25	2	56K OHM	±1%	0603 THICK FILM RESISTOR, 0.10W	GRCW060356K0FK	VISHAY DALE
34	R16	1	0 OHM	0%, JUMPER	0603 THICK FILM RESISTOR, 0.25W	GRCW06030000Z0EAHP	VISHAY DRALORIC
35	R17, R24, R29-R30	4	Do not install				
36	R22, R23, R31-R32	4	0 OHM	0%, JUMPER	0402 THICK FILM RESISTOR, 0.10W	ERJ-2GEOR00X	PANASONIC
37	R28	1	1.8M OHM	±1%	0603 THICK FILM RESISTOR, 0.10W	GRCW06031M80FK	VISHAY DALE
38	P1	1	Do not install				
39	S0-S15, S17, S18, S22-S27	24	NK236		SWITCH, SPDT; THROUGH HOLE; 12V; 0.5A; NK SERIES; RCOIL= OHM; RINSULATION= OHM; APEM	NK236	APEM
40	S19, S21	2	KSR211GLFS		SWITCH, SPST, 32V, 0.05A, SUBMINIATURE TACT SWITCH, RCOIL=10G OHM	KSR211GLFS	C&K COMPONENTS
41	S20	1	Do not install				
42	SH1-SH6	6	STC02SYAN		TEST POINT; JUMPER; STR; TOTAL LENGTH=0.256IN; BLACK; INSULATION=PBT CONTACT=PHOSPHOR BRONZE; COPPER PLATED TIN OVERALL	STC02SYAN	SULLINS ELECTRONICS CORP.
43	U1	1	Do not install				
44	U2	1	MAX7037EGL+		EVKIT PART-IC; TXRX; SUB-1GHZ; ULTRA LOW POWER; RF ISM TRANSCIVER FOR CUSTOMER/INDUSTRIAL APPLICATION; TQFN40-EP 6X6	MAX7037EGL+	MAXIM
45	VB1	1	Do not install				
46	X0-X11, X13-X15	15	Do not install				
47	X12	1	N10214-5212PC		CONNECTOR; FEMALE; THROUGH HOLE; MINI D RIBBON; RIGHT ANGLE; 14PINS	N10214-5212PC	3M ELECTRONIC SOLUTIONS DIVISION
48	X16	1	142-0701-201		CONNECTOR; FEMALE THREADED; THROUGH HOLE; SMA; STRAIGHT THROUGH; 5PINS	142-0701-201	JOHNSON COMPONENTS
49	Z1	1	16MHZ		CRYSTAL; SMT 2.5MMX2MM; 8PFS; 16MHZ; +/-10PPM	NX2520SA-16MHZ-STD-CSX-1	NIHON DEMPYA KOGYO CO
50	Z2	1	32.768KHZ		CRYSTAL; SMT 3.2MMX1.5MM; 12.5PFS; 32.768KHZ; +/-20PPM	9HT10-32.768KEZF-T	TXC CORPORATION
51	PCB	1	PCB		PCB:MAX7037915MHZ	MAX7037915MHZ	MAXIM
TOTAL		168					

MAX7037_315MHz EV Kit Schematics (2)

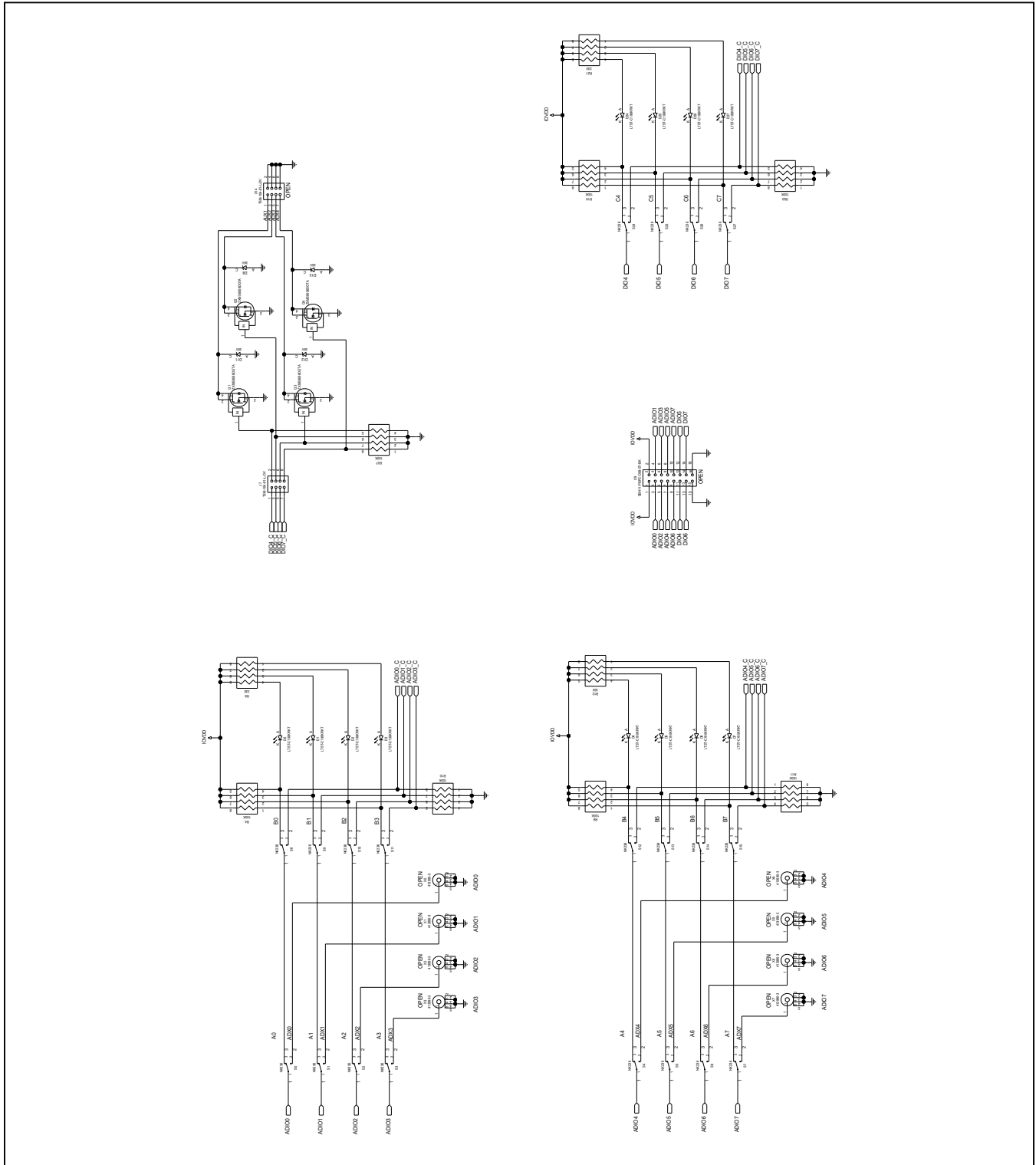

MAX7037_315MHz EV Kit Schematics (3)

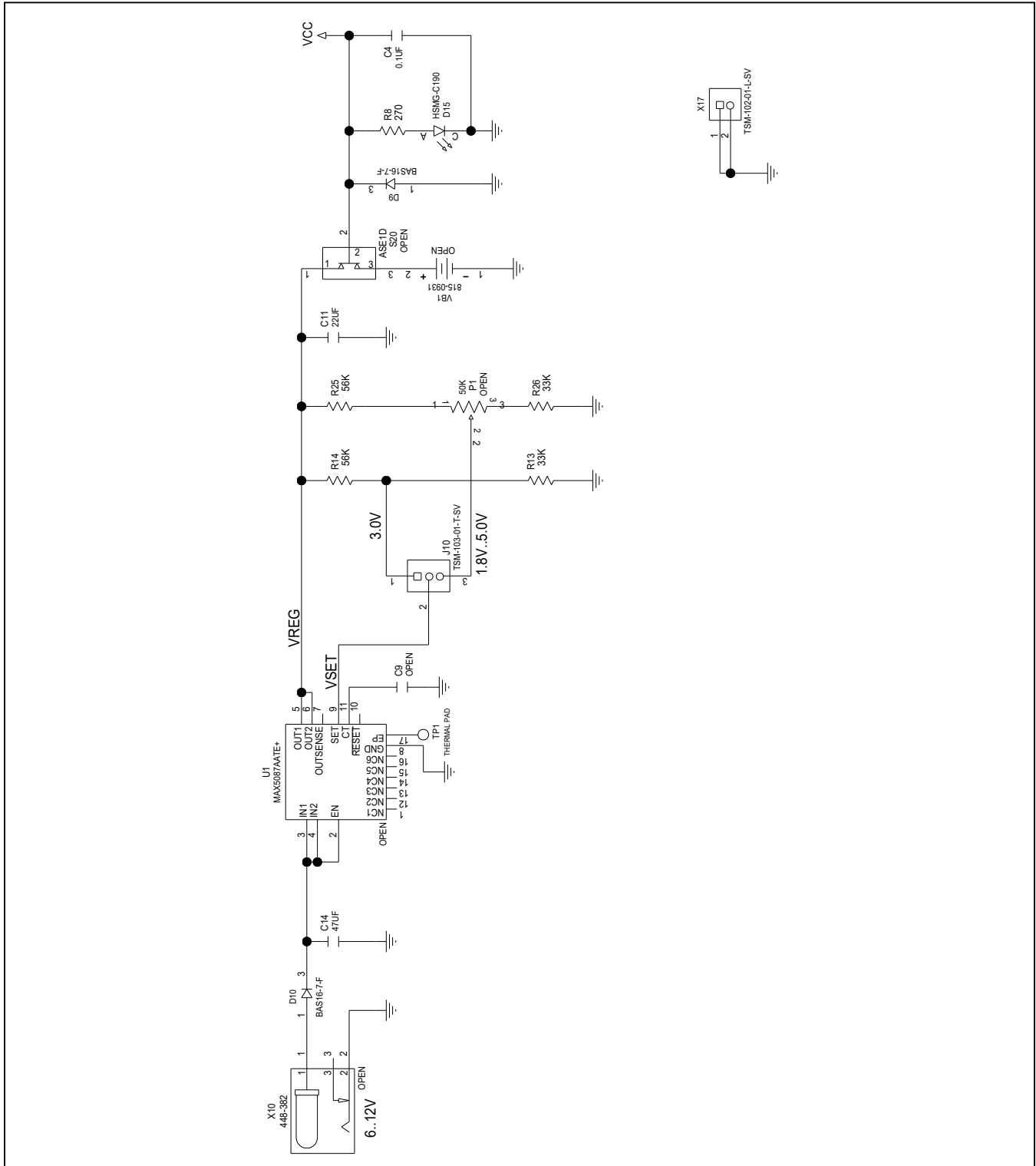

MAX7037_434MHz EV Kit Schematics (1)

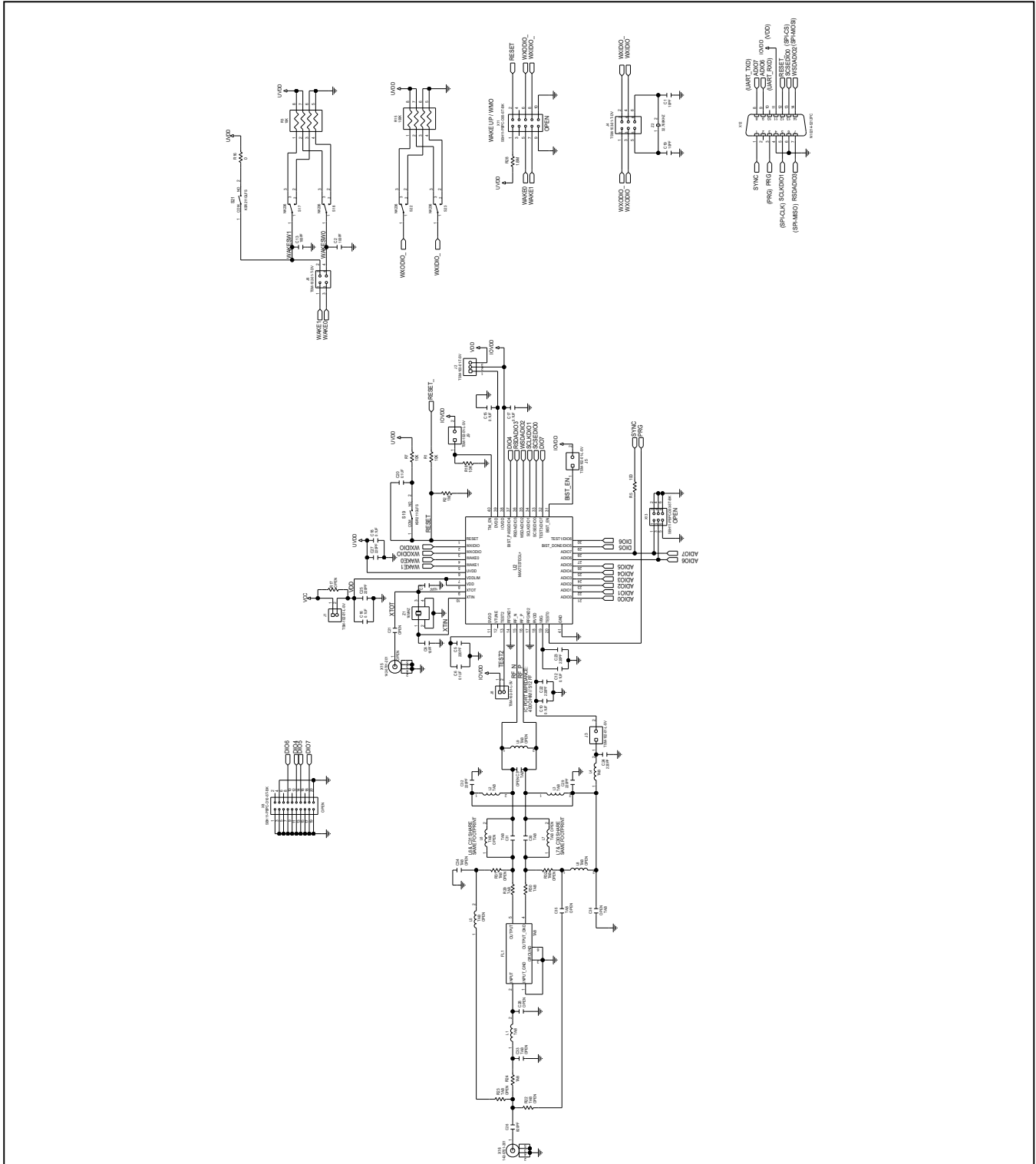

MAX7037_434MHz EV Kit Schematics (2)

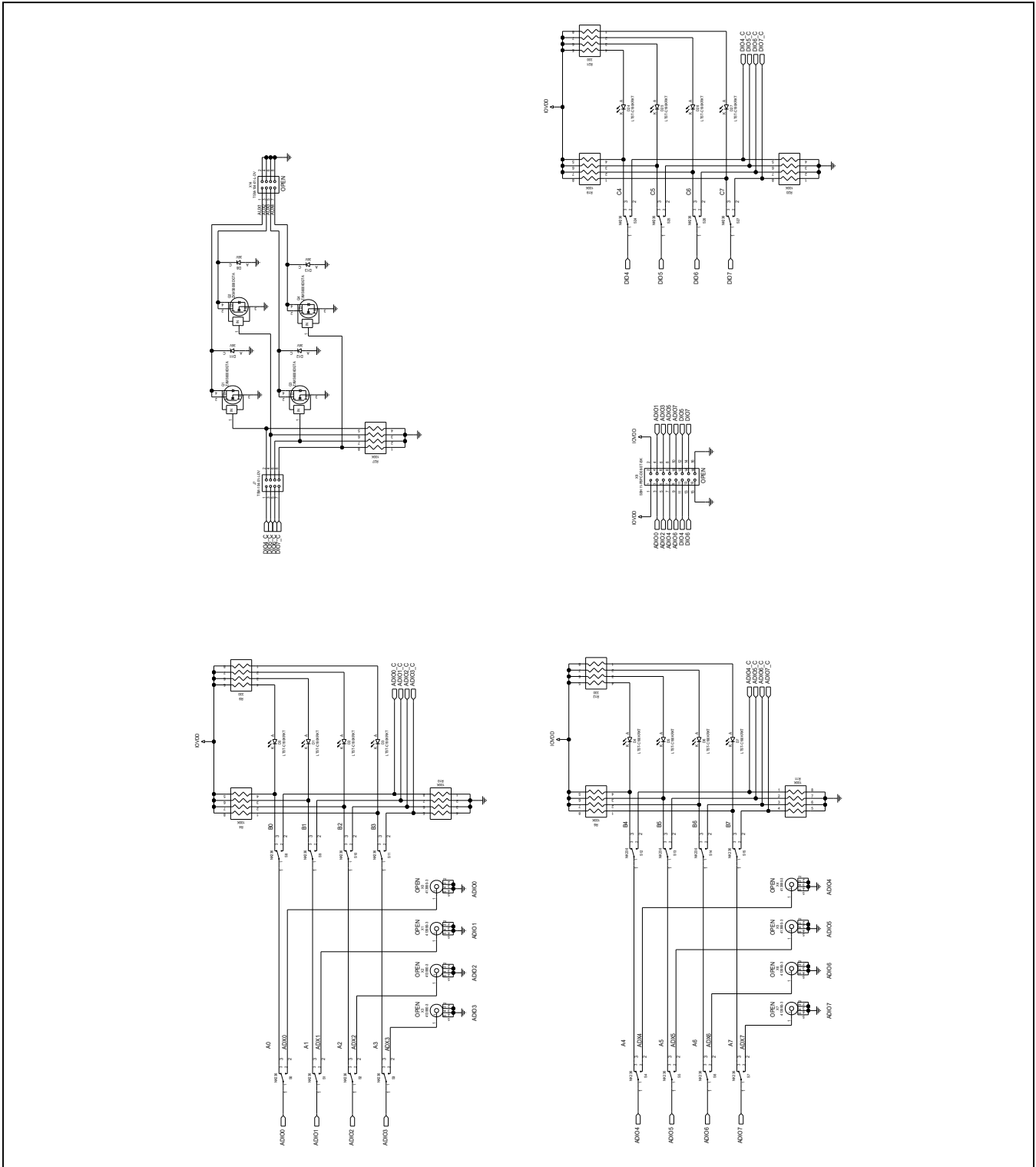

MAX7037_434MHz EV Kit Schematics (3)

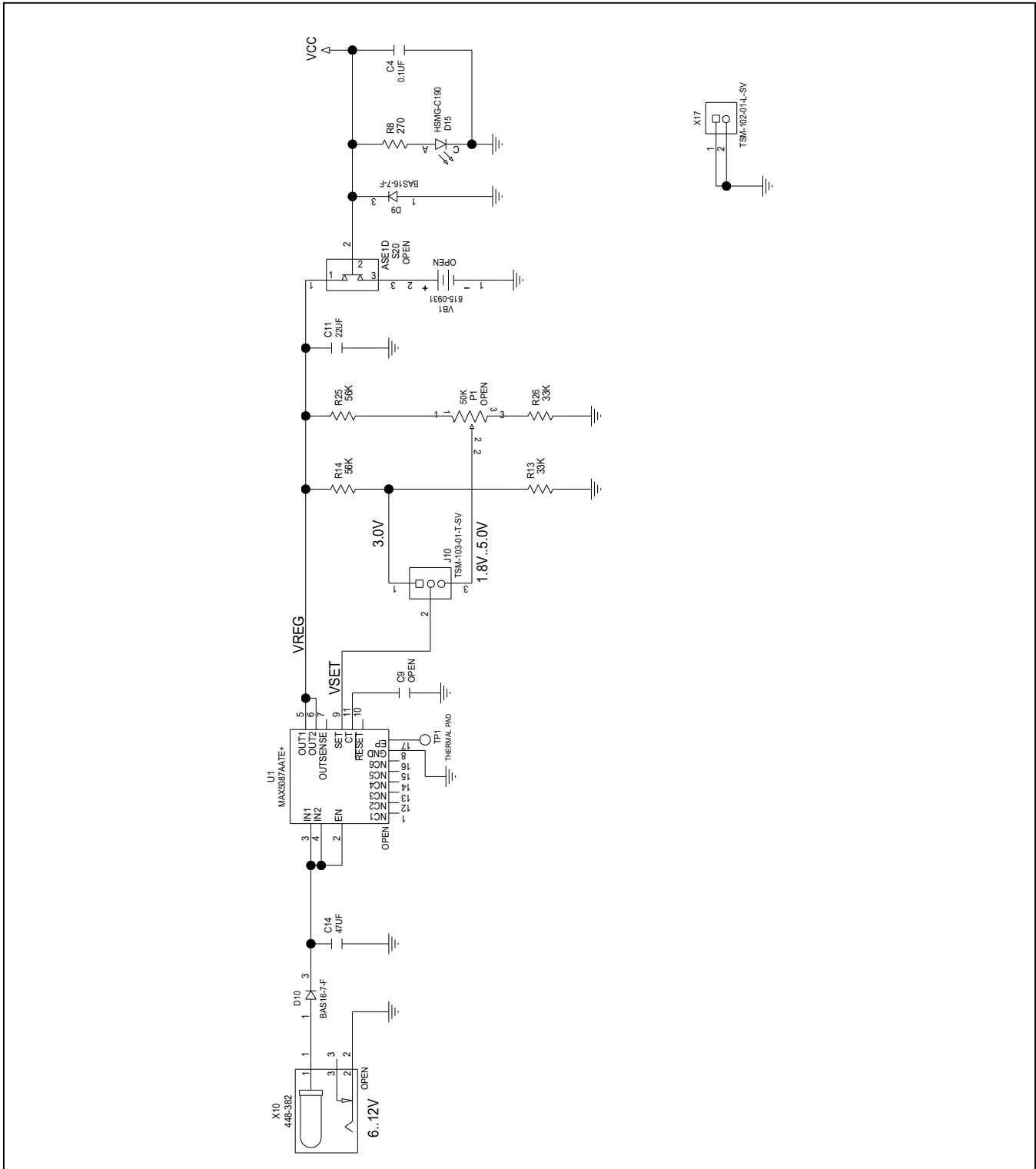

MAX7037_868MHz EV Kit Schematics (1)

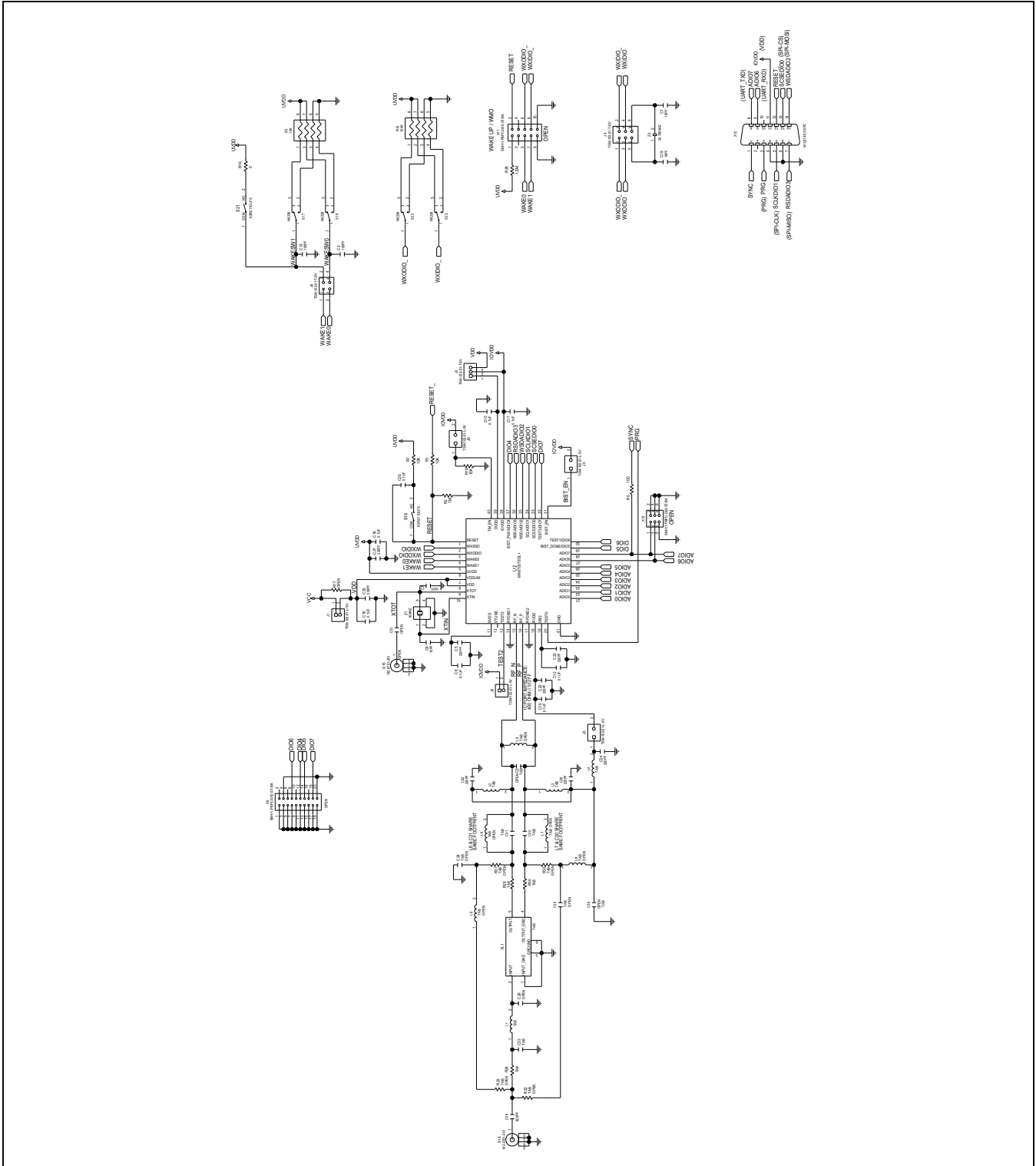

MAX7037_868MHz EV Kit Schematics (2)

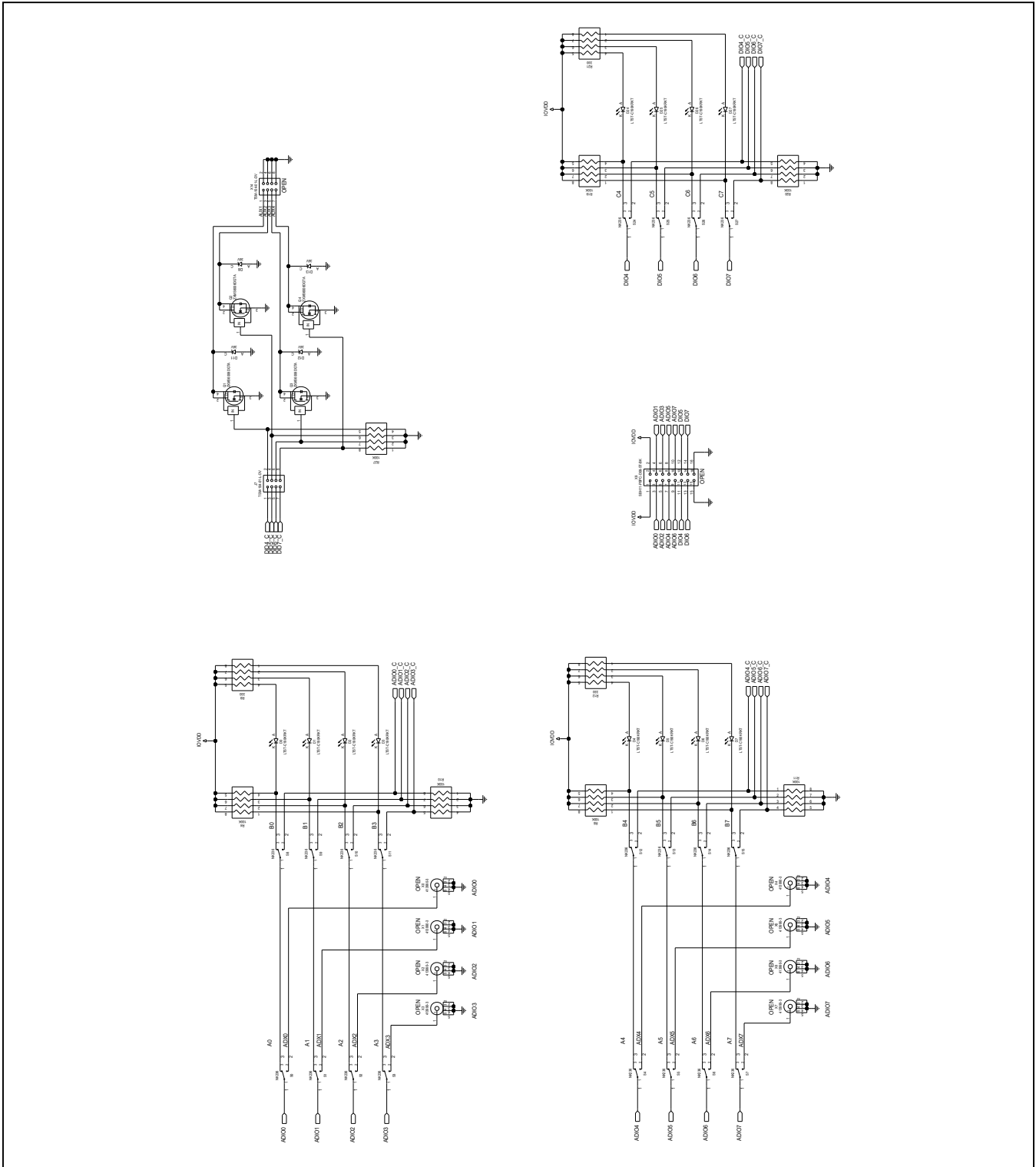

MAX7037_868MHz EV Kit Schematics (3)

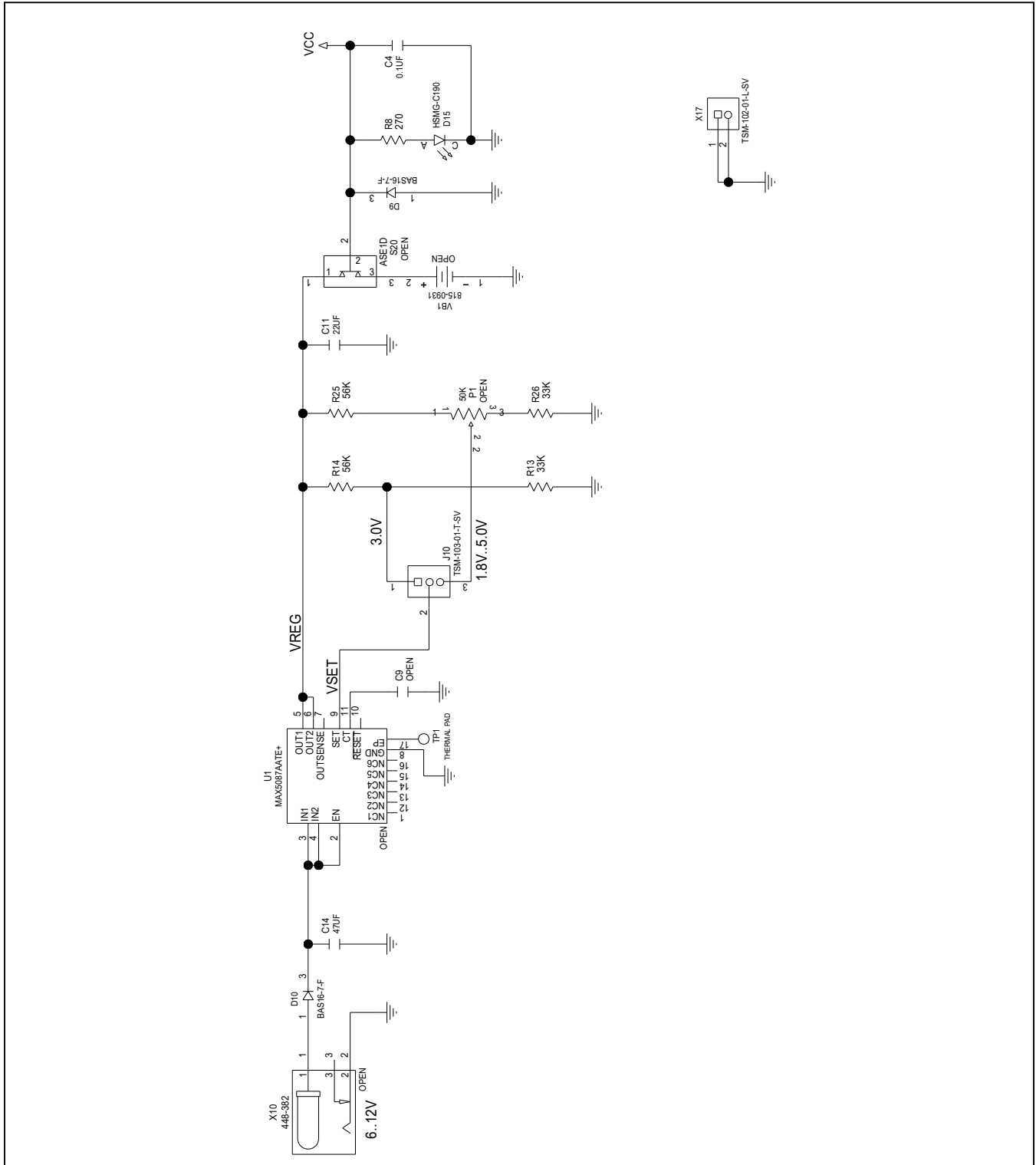

MAX7037_915MHz EV Kit Schematics (1)

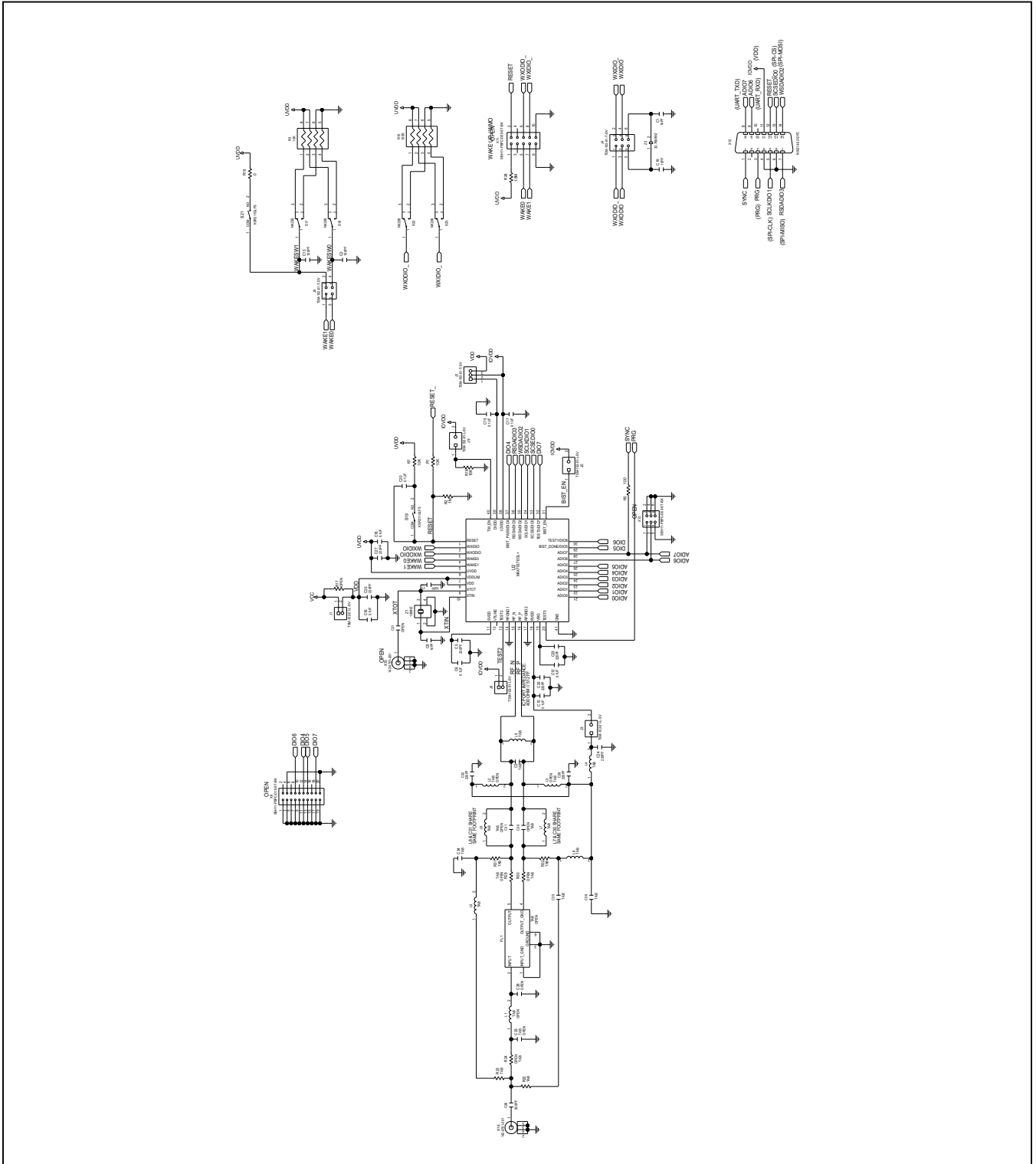

MAX7037_915MHz EV Kit Schematics (2)

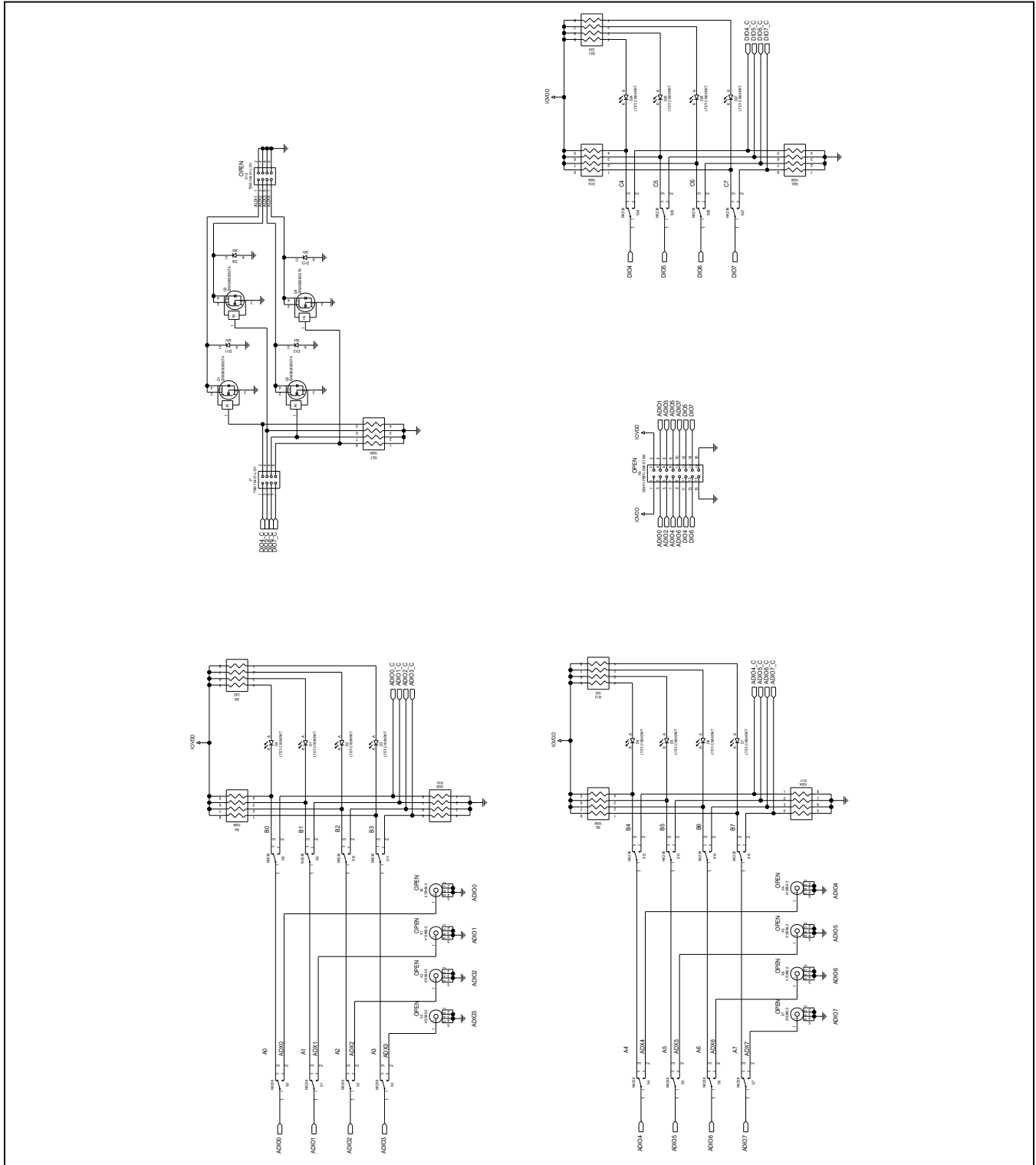

MAX7037_915MHz EV Kit Schematics (3)

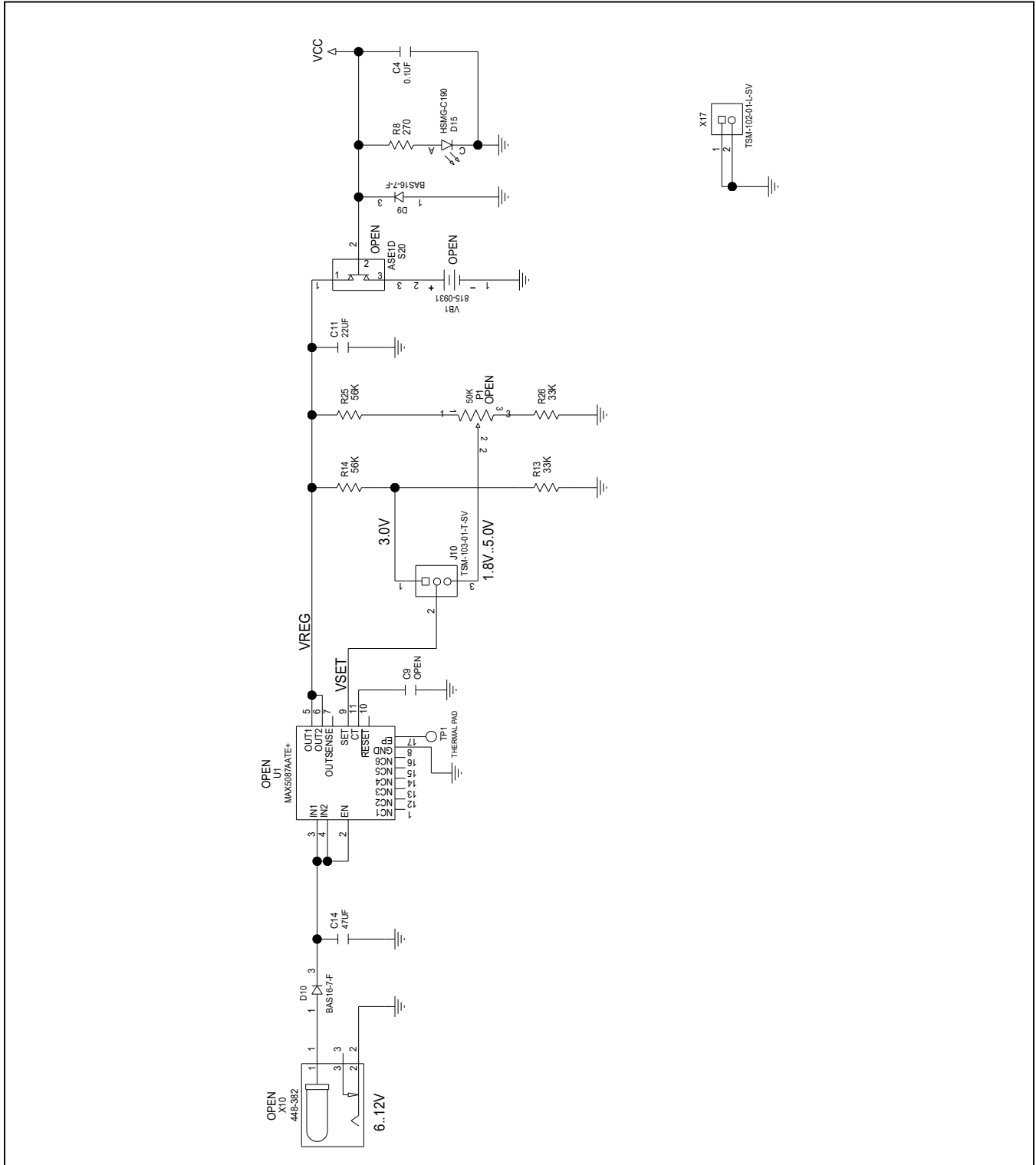

MAX7037_315MHz EV Kit PCB Layout Diagrams

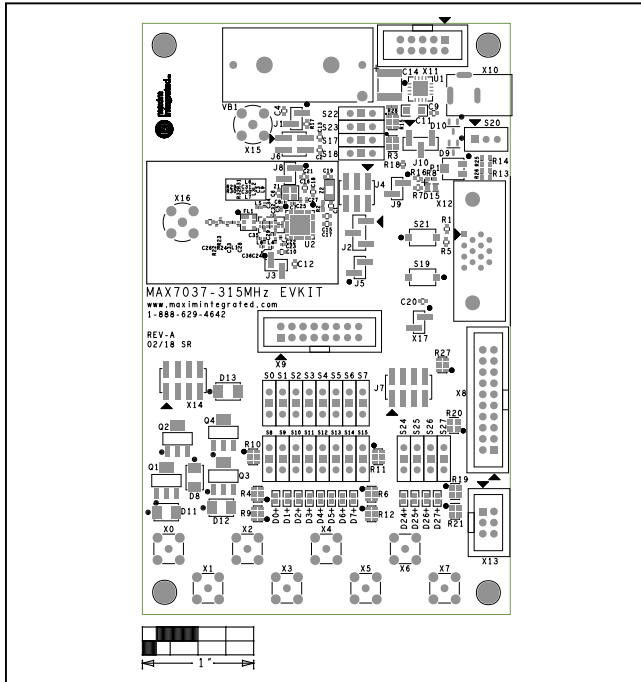

MAX7037 EV Kit—Top Silkscreen

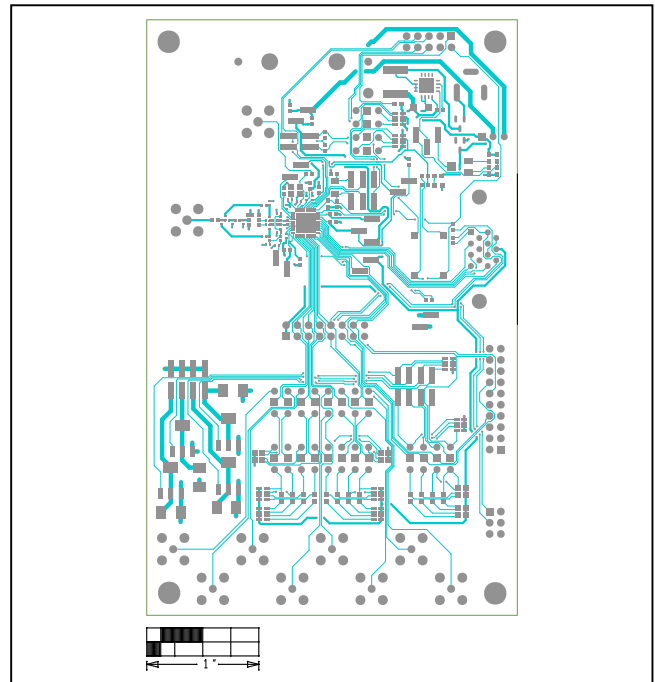

MAX7037 EV Kit—Top

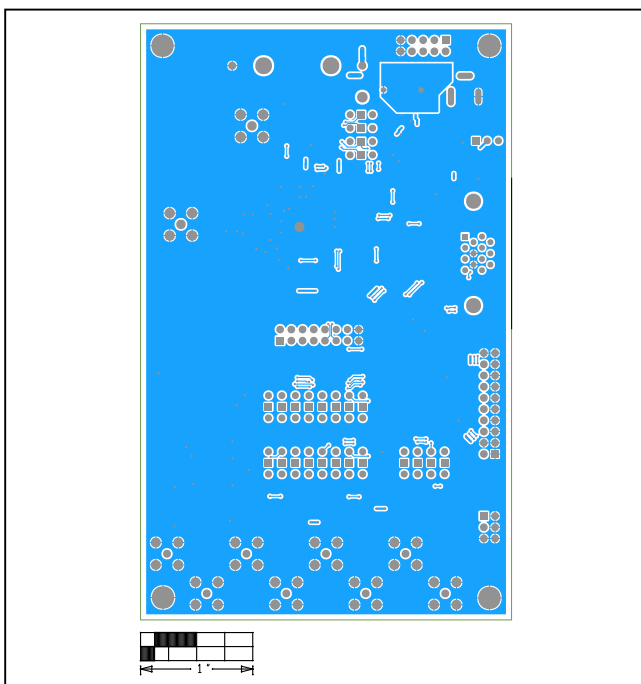

MAX7037 EV Kit—Bottom

MAX7037_434MHz EV Kit PCB Layout Diagrams

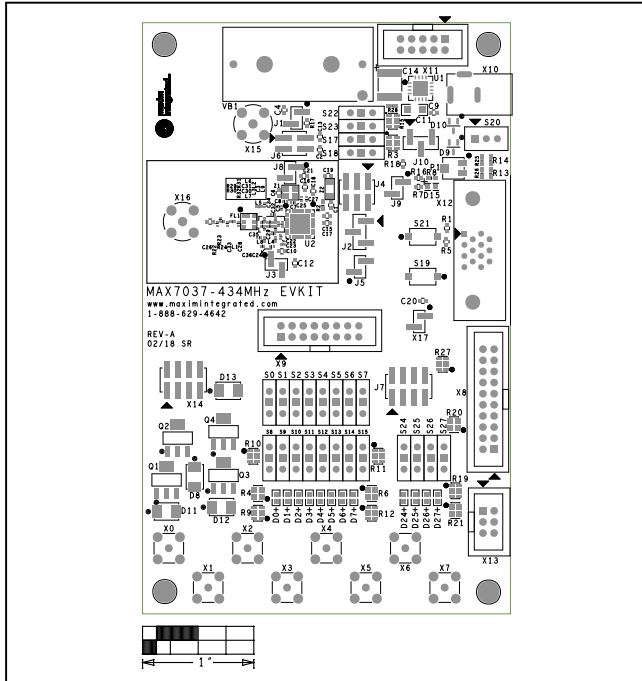

MAX7037 EV Kit—Top Silkscreen

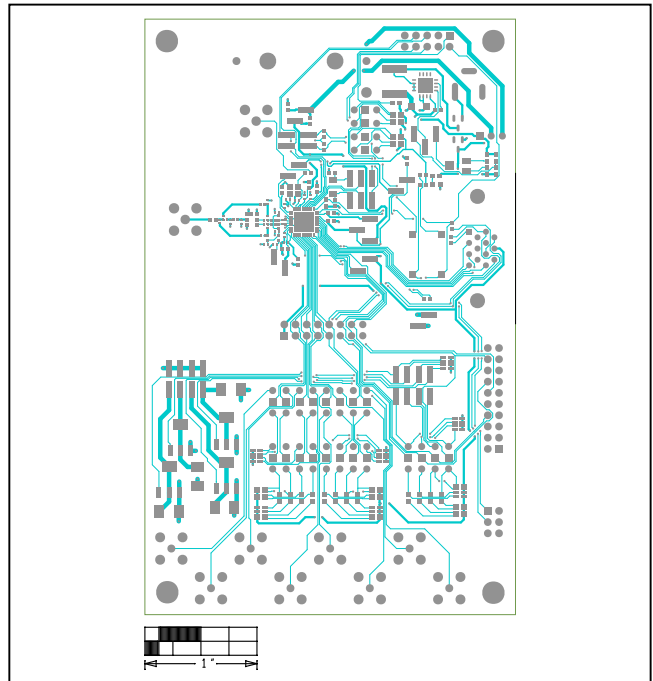

MAX7037 EV Kit—Top

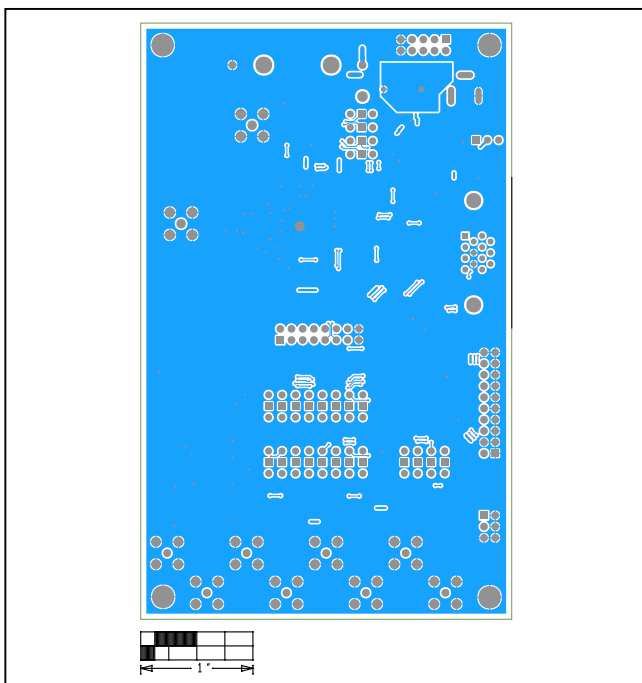

MAX7037 EV Kit—Bottom

MAX7037_868MHz EV Kit PCB Layout Diagrams

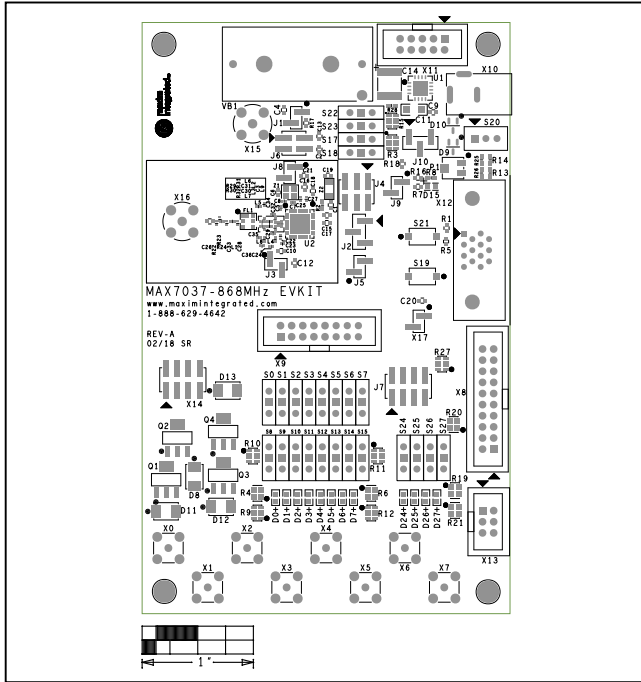

MAX7037 EV Kit—Top Silkscreen

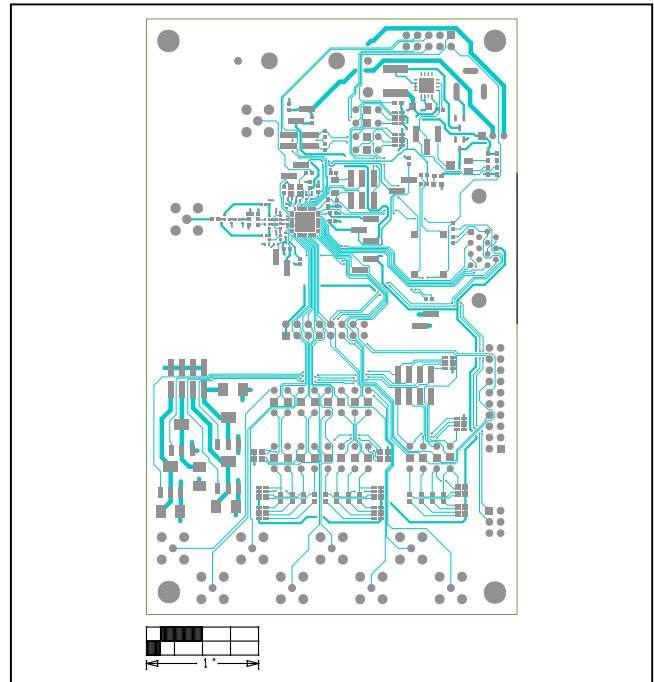

MAX7037 EV Kit—Top

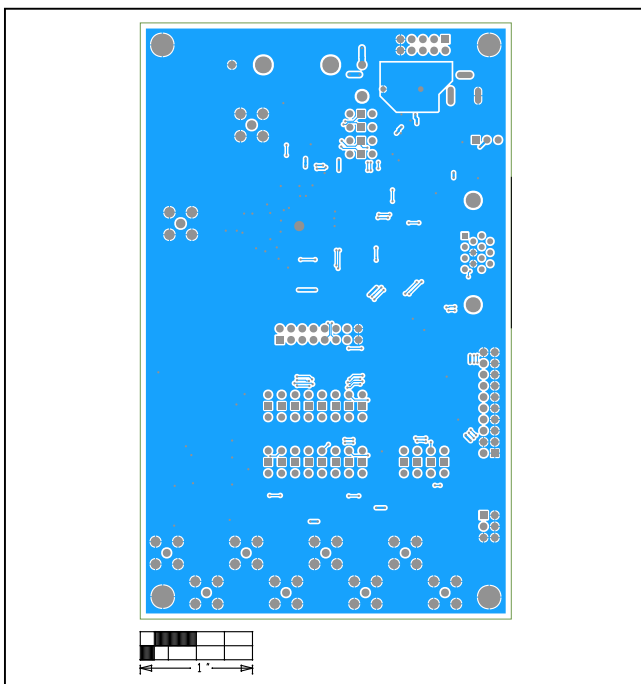

MAX7037 EV Kit—Bottom

MAX7037_915MHz EV Kit PCB Layout Diagrams

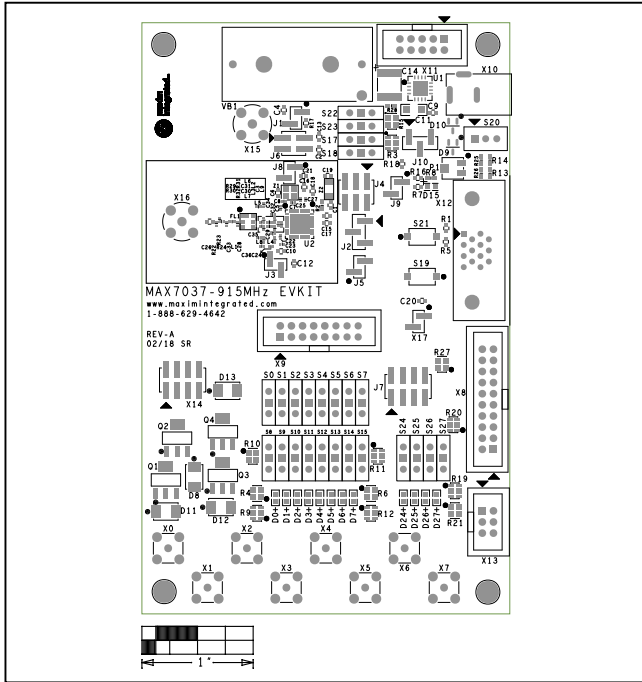

MAX7037 EV Kit—Top Silkscreen

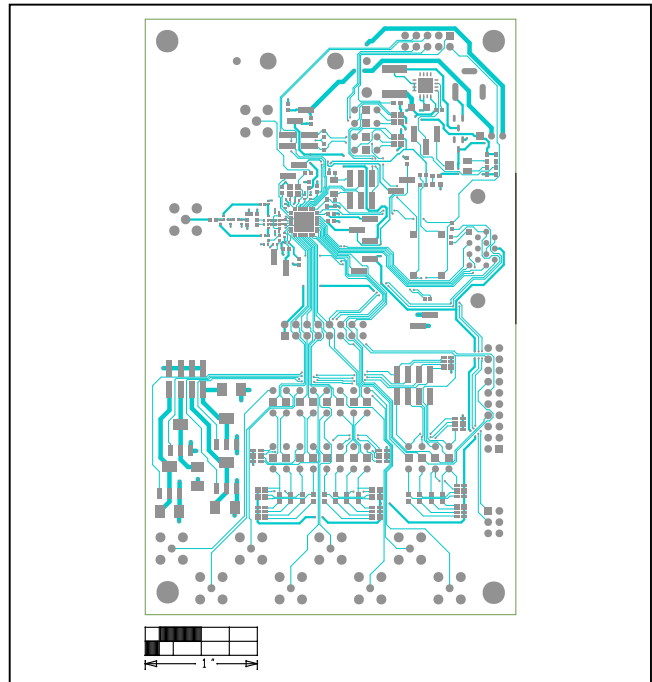

MAX7037 EV Kit—Top

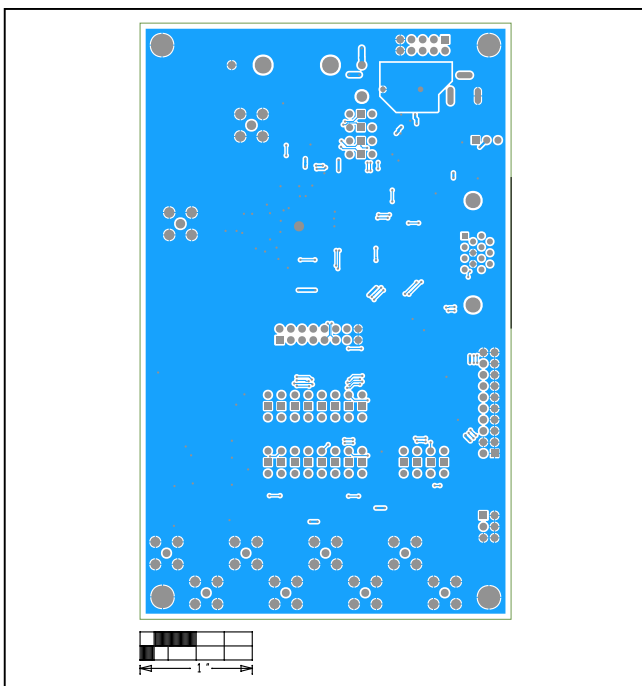

MAX7037 EV Kit—Bottom

Ordering Information

PART	TYPE
MAX7037EVKIT315#	EV Kit
MAX7037EVKIT434#	EV Kit
MAX7037EVKIT868#	EV Kit
MAX7037EVKIT915#	EV Kit
Siam Kitty Board	Interface

#Denotes RoHS compliant.