

MAX7300

2-Wire-Interfaced, 2.5V to 5.5V, 20-Port or 28-Port I/O Expander

General Description

The MAX7300 compact, serial-interfaced, I/O expansion peripheral provides microprocessors with up to 28 ports. Each port is individually user configurable to either a logic input or logic output.

Each port can be configured as either a push-pull logic output capable of sinking 10mA and sourcing 4.5mA, or a Schmitt logic input with optional internal pullup. Seven ports feature configurable transition detection logic, which generates an interrupt upon change of port logic level. The MAX7300 is controlled through an I²C-compatible 2-wire serial interface, and uses four-level logic to allow 16 I²C addresses from only two select pins.

The MAX7300AAX and MAX7300ATL have 28 ports and are available in 36-pin SSOP and 40-pin TQFN packages, respectively. The MAX7300AAI and MAX7300ATI have 20 ports and are available in 28-pin SSOP and TQFN packages. For an SPI-interfaced version, refer to the MAX7301 data sheet. For a pin-compatible port expander with additional 24mA constant-current LED drive capability, refer to the MAX6956 data sheet.

Application

- White Goods
- Industrial Controllers
- System Monitoring

Pin Configurations

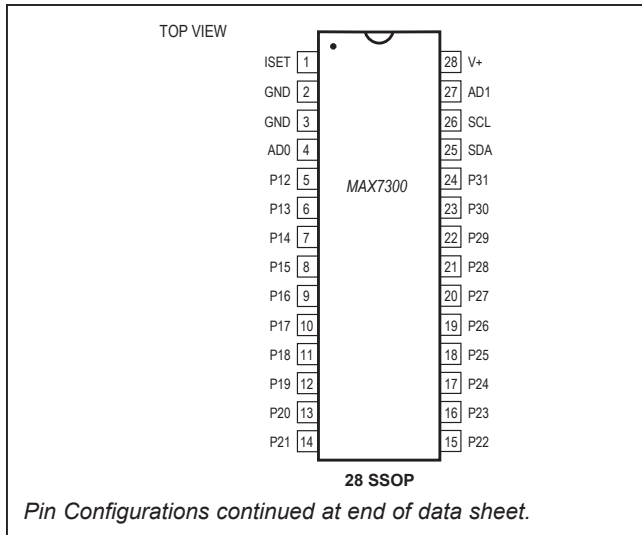

Features

- 400kbps I²C-Compatible Serial Interface
- 2.5V to 5.5V Operation
- -40°C to +125°C Temperature Range
- 20 or 28 I/O Ports, Each Configurable as Push-Pull Logic Output
Schmitt Logic Input
Schmitt Logic Input with Internal Pullup
- 11µA (max) Shutdown Current
- Logic Transition Detection for Seven I/O Ports

Ordering Information

| PART | TEMP RANGE | PIN-PACKAGE |
|------------|-----------------|-------------|
| MAX7300AAI | -40°C to +125°C | 28 SSOP |
| MAX7300ATI | -40°C to +125°C | 28 TQFN-EP* |
| MAX7300AAX | -40°C to +125°C | 36 SSOP |
| MAX7300ATL | -40°C to +125°C | 40 TQFN-EP* |

*EP = Exposed pad.

Devices are also available in a lead(Pb)-free/RoHS-compliant package. Specify lead-free by adding "+" to the part number when ordering. Devices are also available in tape-and-reel packaging. Specify tape and reel by adding "T" to the part number when ordering.

Typical Operating Circuit

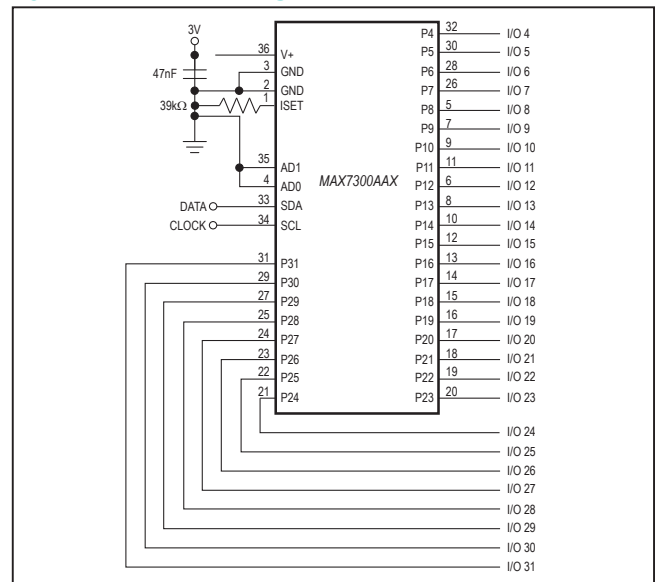

Absolute Maximum Ratings

| | | |
|-------------------------------------------------------|----------------------|-----------------------------------------------------------------------|
| Voltage (with respect to GND) | | 36-Pin SSOP (derate 11.8mW/°C above +70°C).....941mW |
| V+ | -0.3V to +6V | 40-Pin TQFN (derate 26.3mW/°C above T _A = +70°C)....2105mW |
| SCL, SDA, AD0, AD1 | -0.3V to +6V | Operating Temperature Range |
| All Other Pins | -0.3V to (V+ + 0.3V) | T _{MIN} to T _{MAX}) |
| P4–P31 Current | ±30mA | Junction Temperature..... |
| GND Current | 800mA | Storage Temperature Range |
| Continuous Power Dissipation (T _A = +70°C) | | Lead Temperature (soldering, 10s) |
| 28-Pin SSOP (derate 9.1mW/°C above +70°C)..... | 727mW | Soldering Temperature (reflow) |
| 28-Pin TQFN (derate 21.3mW/°C above +70°C)..... | 1702mW | Lead (Pb)-free packages |
| | | Packages containing lead (Pb)..... |

Stresses beyond those listed under “Absolute Maximum Ratings” may cause permanent damage to the device. These are stress ratings only, and functional operation of the device at these or any other conditions beyond those indicated in the operational sections of the specifications is not implied. Exposure to absolute maximum rating conditions for extended periods may affect device reliability.

Electrical Characteristics

(Typical Operating Circuit, V_{V+} = 2.5V to 5.5V, T_A = T_{MIN} to T_{MAX}, unless otherwise noted.) (Note 1)

| PARAMETER | SYMBOL | CONDITIONS | MIN | TYP | MAX | UNITS |
|--------------------------------------|-----------------------------------|-----------------------------------------------------------------------------------------|--------------------------------------|----------|------|-------|
| Operating Supply Voltage | V+ | | 2.5 | | 5.5 | V |
| Shutdown Supply Current | I _{SHDN} | All digital inputs at V+ or GND | T _A = +25°C | 5.5 | 8 | µA |
| | | | T _A = -40°C to +85°C | | 10 | |
| | | | T _{MIN} to T _{MAX} | | 11 | |
| Operating Supply Current | I _{GPOH} | All ports programmed as outputs high, no load, all other inputs at V+ or GND | T _A = +25°C | 180 | 240 | µA |
| | | | T _A = -40°C to +85°C | | 260 | |
| | | | T _{MIN} to T _{MAX} | | 280 | |
| Operating Supply Current | I _{GPOL} | All ports programmed as outputs low, no load, all other inputs at V+ or GND | T _A = +25°C | 170 | 210 | µA |
| | | | T _A = -40°C to +85°C | | 230 | |
| | | | T _{MIN} to T _{MAX} | | 240 | |
| Operating Supply Current | I _{GPI} | All ports programmed as inputs without pullup, ports, and all other inputs at V+ or GND | T _A = +25°C | 110 | 135 | µA |
| | | | T _A = -40°C to +85°C | | 140 | |
| | | | T _{MIN} to T _{MAX} | | 145 | |
| INPUTS AND OUTPUTS | | | | | | |
| Logic High Input Voltage Port Inputs | V _{IH} | | 0.7 x V+ | | | V |
| Logic Low Input Voltage Port Inputs | V _{IL} | | | 0.3 x V+ | | V |
| Input Leakage Current | I _{IH} , I _{IL} | GPIO inputs without pullup, V _{PORT} = V+ to GND | -100 | ±1 | +100 | nA |
| GPIO Input Internal Pullup to V+ | I _{PU} | V _{V+} = 2.5V | 12 | 19 | 30 | µA |
| | | V _{V+} = 5.5V | 80 | 120 | 180 | |
| Hysteresis Voltage GPIO Inputs | ΔV _I | | | 0.3 | | V |

Electrical Characteristics (continued)(Typical Operating Circuit, $V_{V+} = 2.5V$ to $5.5V$, $T_A = T_{MIN}$ to T_{MAX} , unless otherwise noted.) (Note 1)

| PARAMETER | SYMBOL | CONDITIONS | MIN | TYP | MAX | UNITS |
|------------------------------------------|------------------|------------------------------------------------------------------------------|--------------------------|-----|--------------------------|-------|
| Output High Voltage | V_{OH} | GPIO outputs, $I_{SOURCE} = 2mA$, $T_A = -40^{\circ}C$ to $+85^{\circ}C$ | $V_{V+} -$ 0.7 | | | V |
| | | GPIO outputs, $I_{SOURCE} = 1mA$, $T_A = T_{MIN}$ to T_{MAX} (Note 2) | $V_{V+} -$ 0.7 | | | |
| Port Sink Current | I_{OL} | $V_{PORT} = 0.6V$ | 2 | 10 | 18 | mA |
| Output Short-Circuit Current | I_{OLSC} | Port configured output low, shorted to V_{V+} | 2.75 | 11 | 20 | mA |
| Input High-Voltage SDA, SCL, AD0, AD1 | V_{IH} | | $0.7 \times$ V_{V+} | | | V |
| Input Low-Voltage SDA, SCL, AD0, AD1 | V_{IL} | | | | $0.3 \times$ V_{V+} | V |
| Input Leakage Current SDA, SCL | I_{IH}, I_{IL} | | -50 | | +50 | nA |
| Input Capacitance | | (Note 2) | | | 10 | pF |
| Output Low-Voltage SDA | V_{OL} | $I_{SINK} = 6mA$ | | | 0.4 | V |

Timing Characteristics (Figure 2)(V_{V+} = 2.5V to 5.5V, T_A = T_{MIN} to T_{MAX}, unless otherwise noted.) (Note 1)

| PARAMETER | SYMBOL | CONDITIONS | MIN | TYP | MAX | UNITS |
|-------------------------------------------------------|---------------|--------------|-----|------------------|-----|---------|
| Serial Clock Frequency | f_{SCL} | | | | 400 | kHz |
| Bus Free Time Between a STOP and a START Condition | t_{BUF} | | 1.3 | | | μs |
| Hold Time (Repeated) START Condition | $t_{HD, STA}$ | | 0.6 | | | μs |
| Repeated START Condition Setup Time | $t_{SU, STA}$ | | 0.6 | | | μs |
| STOP Condition Setup Time | $t_{SU, STO}$ | | 0.6 | | | μs |
| Data Hold Time | $t_{HD, DAT}$ | (Note 3) | 15 | | 900 | ns |
| Data Setup Time | $t_{SU, DAT}$ | | 100 | | | ns |
| SCL Clock Low Period | t_{LOW} | | 1.3 | | | μs |
| SCL Clock High Period | t_{HIGH} | | 0.7 | | | μs |
| Rise Time of Both SDA and SCL Signals, Receiving | t_R | (Notes 2, 4) | | 20 + $0.1C_b$ | 300 | ns |
| Fall Time of Both SDA and SCL Signals, Receiving | t_F | (Notes 2, 4) | | 20 + $0.1C_b$ | 300 | ns |
| Fall Time of SDA Transmitting | $t_{F, TX}$ | (Notes 2, 5) | | 20 + $0.1C_b$ | 250 | ns |
| Pulse Width of Spike Suppressed | t_{SP} | (Notes 2, 6) | 0 | | 50 | ns |
| Capacitive Load for Each Bus Line | C_b | (Note 2) | | | 400 | pF |

Timing Characteristics (Figure 2) (continued)

($V_{V+} = 2.5V$ to $5.5V$, $T_A = T_{MIN}$ to T_{MAX} , unless otherwise noted.) (Note 1)

- Note 1:** All parameters tested at $T_A = +25^\circ C$. Specifications over temperature are guaranteed by design.
- Note 2:** Guaranteed by design.
- Note 3:** A master device must provide a hold time of at least 300ns for the SDA signal (referred to VIL of the SCL signal) in order to bridge the undefined region of SCL's falling edge.
- Note 4:** C_b = total capacitance of one bus line in pF. t_R and t_F measured between 0.3V+ and 0.7V+.
- Note 5:** $I_{SINK} \leq 6mA$. C_b = total capacitance of one bus line in pF. t_R and t_F measured between 0.3V+ and 0.7V+.
- Note 6:** Input filters on the SDA and SCL inputs suppress noise spikes less than 50ns.

Typical Operating Characteristics

($R_{ISET} = 39k\Omega$, $T_A = +25^\circ C$, unless otherwise noted.)

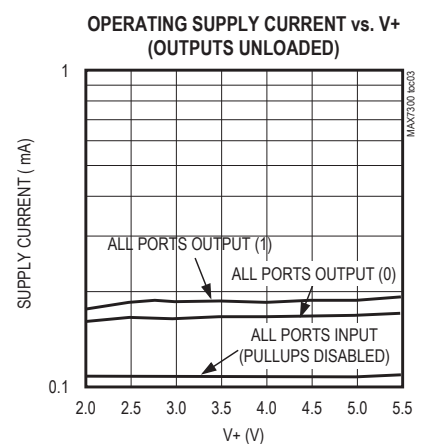
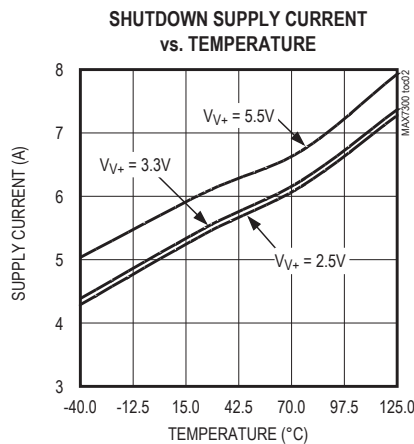
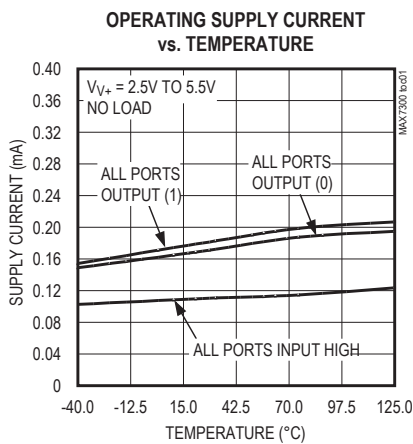

Typical Operating Characteristics (continued)

($R_{ISET} = 39k\Omega$, $T_A = +25^\circ C$, unless otherwise noted.)

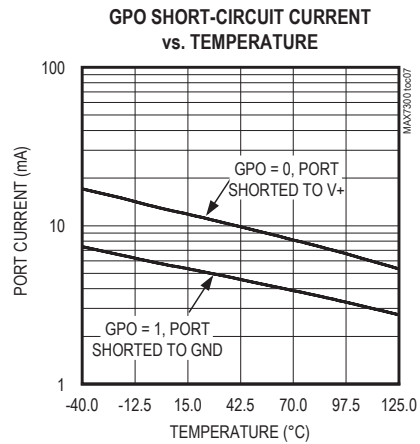
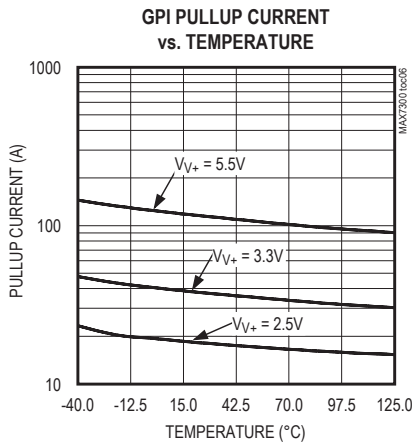
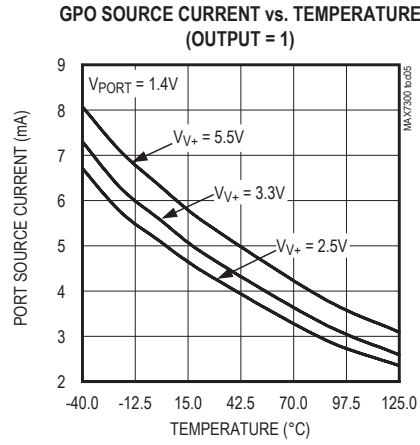
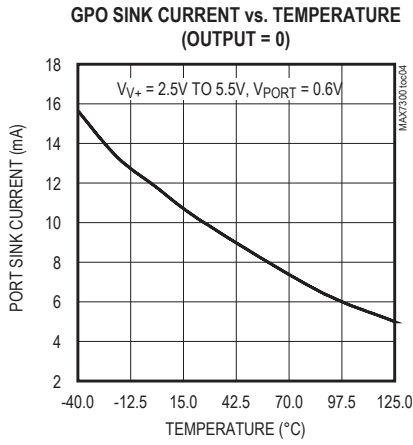

Pin Description

| PIN | | | | NAME | FUNCTION |
|---------|------------|---------|-----------------------|---------|------------------------------------------------------------------------------------------------------------------------------------------------------------------------------|
| 28 SSOP | 28 TQFN-EP | 36 SSOP | 40 TQFN-EP | | |
| 1 | 26 | 1 | 36 | ISET | Bias Current Setting. Connect ISET to GND through a resistor (R_{ISET}) value of 39k Ω to 120k Ω . |
| 2, 3 | 27, 28 | 2, 3 | 37, 38, 39 | GND | Ground |
| 4 | 1 | 4 | 40 | AD0 | Address Input 0. Sets device slave address. Connect to either GND, V+, SCL, SDA to give four logic combinations. See Table 3. |
| 5–24 | 2–21 | — | — | P12–P31 | I/O Ports. P12 to P31 can be configured as push-pull outputs, CMOS-logic inputs, or CMOS-logic inputs with weak pullup resistor. |
| — | — | 5–32 | 1–10, 12–19, 21–30 | P4–P31 | I/O Ports. P4 to P31 can be configured as push-pull outputs, CMOS-logic inputs, or CMOS-logic inputs with weak pullup resistor. |
| — | — | — | 11, 20, 31 | N.C. | No Connection. Not internally connected. |
| 25 | 22 | 33 | 32 | SDA | I ² C-Compatible Serial-Data I/O |
| 26 | 23 | 34 | 33 | SCL | I ² C-Compatible Serial-Clock Input |
| 27 | 24 | 35 | 34 | AD1 | Address Input 1. Sets device slave address. Connect to either GND, V+, SCL, SDA to give four logic combinations. See Table 3. |
| 28 | 25 | 36 | 35 | V+ | Positive Supply Voltage. Bypass V+ to GND with minimum 0.047 μ F capacitor. |
| — | — | — | — | EP | Exposed Pad (TQFN Only). EP is internally connected to GND. Connect to a large ground plane to maximize thermal performance. Not intended as an electrical connection point. |

Detailed Description

The MAX7300 general-purpose input/output (GPIO) peripheral provides up to 28 I/O ports, P4 to P31, controlled through an I²C-compatible serial interface. The ports can be configured to any combination of logic inputs and logic outputs, and default to logic inputs on power-up.

Figure 1 is the MAX7300 functional diagram. Any I/O port can be configured as a push-pull output (sinking 10mA, sourcing 4.5mA), or a Schmitt-trigger logic input. Each input has an individually selectable internal pullup resistor. Additionally, transition detection allows seven ports (P24 to P30) to be monitored in any maskable combination for changes in their logic status. A detected transition is flagged through a status register bit, as well as an interrupt pin (port P31), if desired.

The port configuration registers individually set the 28 ports, P4 to P31, as GPIO. A pair of bits in registers 0x09 through 0x0F sets each port's configuration (Tables 1 and 2).

The 36-pin MAX7300AAX and 40-pin MAX7300ATL have 28 ports, P4 to P31. The 28-pin MAX7300ANI, MAX7300AAI, and MAX7300ATI have only 20 ports available, P12 to P31. The eight unused ports should be configured as outputs on power-up by writing 0x55 to

registers 0x09 and 0x0A. If this is not done, the eight unused ports remain as unconnected inputs and quiescent supply current rises, although there is no damage to the part.

Register Control of I/O Ports Across Multiple Drivers

The MAX7300 offers 20 or 28 I/O ports, depending on package choice. Two addressing methods are available. Any single port (bit) can be written (set/cleared) at once; or, any sequence of eight ports can be written (set/cleared) in any combination at once. There are no boundaries; it is equally acceptable to write P0 to P7, P1 to P8, or P31 to P38 (P32 to P38 are nonexistent, so the instructions to these bits are ignored).

Shutdown

When the MAX7300 is in shutdown mode, all ports are forced to inputs, and the pullup current sources are turned off. Data in the port and control registers remain unaltered, so port configuration and output levels are restored when the MAX7300 is taken out of shutdown. The MAX7300 can still be programmed while in shutdown mode. For minimum supply current in shutdown mode, logic inputs should be at GND or V+ potential. Shutdown mode is exited by setting the S bit in the configuration register (Table 8).

Table 1. Port Configuration Map

| REGISTER | ADDRESS CODE (HEX) | REGISTER DATA | | | | | | | |
|-------------------------------------------|--------------------|---------------|-----|-----|-----|----|----|----|----|
| | | D7 | D6 | D5 | D4 | D3 | D2 | D1 | D0 |
| Port Configuration for P7, P6, P5, P4 | 0x09 | P7 | P6 | P5 | P4 | | | | |
| Port Configuration for P11, P10, P9, P8 | 0x0A | P11 | P10 | P9 | P8 | | | | |
| Port Configuration for P15, P14, P13, P12 | 0x0B | P15 | P14 | P13 | P12 | | | | |
| Port Configuration for P19, P18, P17, P16 | 0x0C | P19 | P18 | P17 | P16 | | | | |
| Port Configuration for P23, P22, P21, P20 | 0x0D | P23 | P22 | P21 | P20 | | | | |
| Port Configuration for P27, P26, P25, P24 | 0x0E | P27 | P26 | P25 | P24 | | | | |
| Port Configuration for P31, P30, P29, P28 | 0x0F | P31 | P30 | P29 | P28 | | | | |

Table 2. Port Configuration Matrix

| MODE | FUNCTION | PORT REGISTER (0x20–0x5F) | PIN BEHAVIOR | ADDRESS CODE (HEX) | PORT CONFIGURATION BIT PAIR | |
|-------------------------|---------------------------|----------------------------------|---------------------------------|--------------------|-----------------------------|-------|
| | | | | | UPPER | LOWER |
| DO NOT USE THIS SETTING | | | | 0x09 to 0x0F | 0 | 0 |
| Output | GPIO Output | Register bit = 0 | Active-low logic output | 0x09 to 0x0F | 0 | 1 |
| | | Register bit = 1 | Active-high logic output | | | |
| Input | GPIO Input without Pullup | Register bit = input logic level | Schmitt logic input | 0x09 to 0x0F | 1 | 0 |
| | | | Schmitt logic input with pullup | | | |

Serial Interface

Serial Addressing

The MAX7300 operates as a slave that sends and receives data through an I²C-compatible 2-wire interface. The interface uses a serial data line (SDA) and a serial clock line (SCL) to achieve bidirectional communication between master(s) and slave(s). A master (typically a microcontroller) initiates all data transfers to and from the MAX7300, and generates the SCL clock that synchronizes the data transfer (Figure 2).

The MAX7300 SDA line operates as both an input and an open-drain output. A pullup resistor, typically 4.7kΩ, is required on SDA. The MAX7300 SCL line operates only as an input. A pullup resistor, typically 4.7kΩ, is required on SCL if there are multiple masters on the 2-wire interface, or if the master in a single-master system has an open-drain SCL output.

Each transmission consists of a START condition (Figure 3) sent by a master, followed by the MAX7300 7-bit slave address plus R/W bit (Figure 6), a register address byte, one or more data bytes, and finally a STOP condition (Figure 3).

START and STOP Conditions

Both SCL and SDA remain high when the interface is not busy. A master signals the beginning of a transmission with a START (S) condition by transitioning SDA from high to low while SCL is high. When the master has finished communicating with the slave, it issues a STOP (P) condition by transitioning SDA from low to high while SCL is high. The bus is then free for another transmission (Figure 3).

Bit Transfer

One data bit is transferred during each clock pulse. The data on SDA must remain stable while SCL is high (Figure 4).

Acknowledge

The acknowledge bit is a clocked 9th bit, which the recipient uses to handshake receipt of each byte of data (Figure 5). Thus, each byte transferred effectively requires 9 bits. The master generates the 9th clock pulse, and the recipient pulls down SDA during the acknowledge clock pulse, such that the SDA line is stable low during the high period of the clock pulse. When the master is transmitting to the MAX7300, the MAX7300 generates the acknowledge bit since the

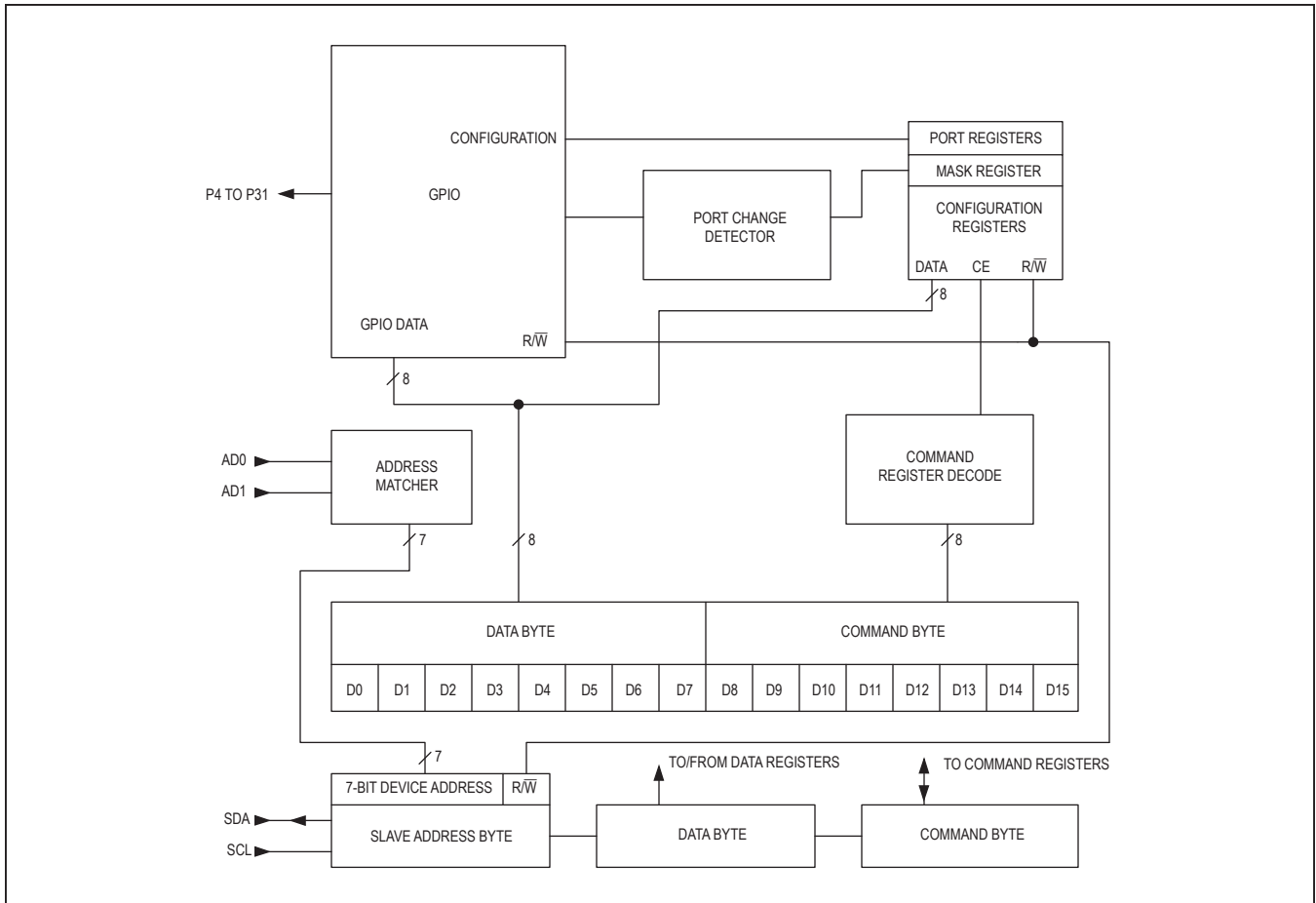

Figure 1. MAX7300 Functional Diagram

MAX7300 is the recipient. When the MAX7300 is transmitting to the master, the master generates the acknowledge bit since the master is the recipient.

Slave Address

The MAX7300 has a 7-bit-long slave address (Figure 6). The eighth bit following the 7-bit slave address is the $\overline{R/W}$ bit. It is low for a write command and high for a read command.

The first 3 bits (MSBs) of the MAX7300 slave address are always 100. Slave address bits A3, A2, A1, and A0 are selected by the address inputs, AD1 and AD0. These two input pins can be connected to GND, V+, SDA, or SCL. The MAX7300 has 16 possible slave

addresses (Table 3), and therefore a maximum of 16 MAX7300 devices can share the same interface.

Message Format for Writing the MAX7300

A write to the MAX7300 comprises the transmission of the MAX7300's slave address with the $\overline{R/W}$ bit set to zero, followed by at least 1 byte of information. The first byte of information is the command byte. The command byte determines which register of the MAX7300 is to be written by the next byte, if received. If a STOP condition is detected after the command byte is received, then the MAX7300 takes no further action (Figure 7) beyond storing the command byte.

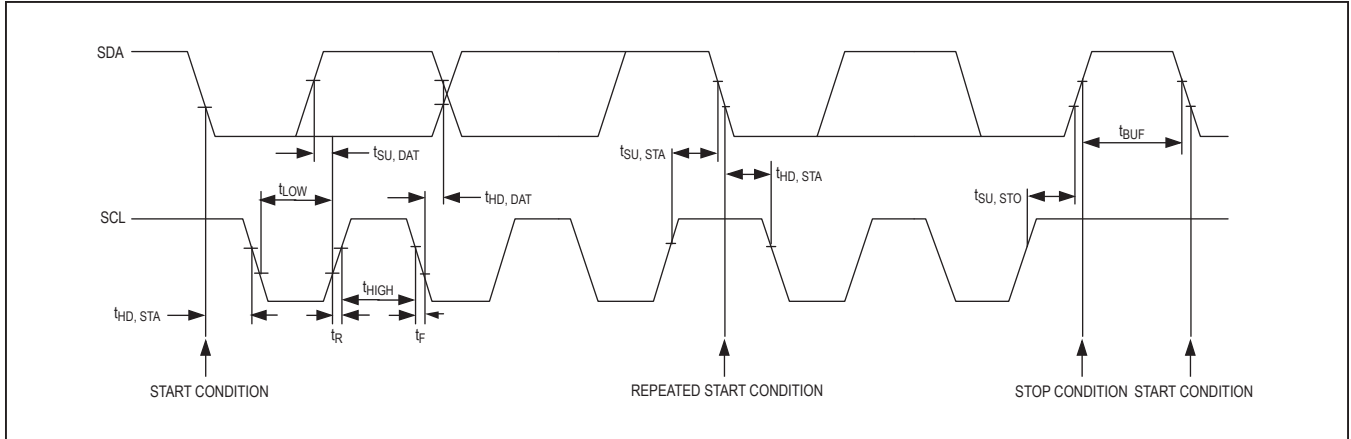

Figure 2. 2-Wire Serial Interface Timing Details

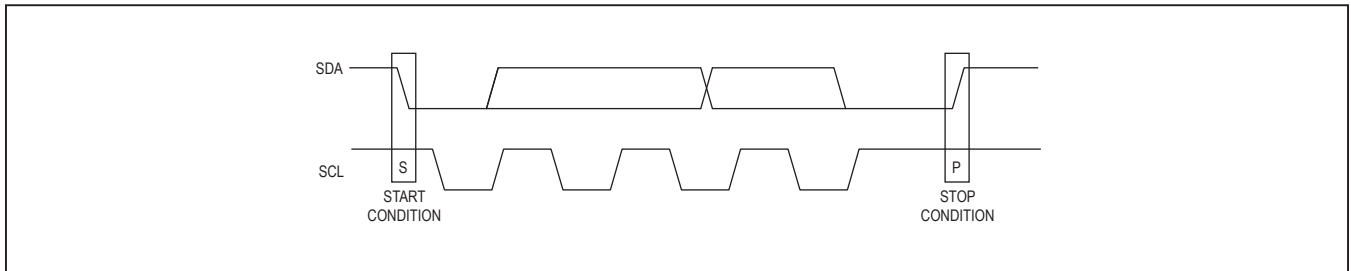

Figure 3. Start and Stop Conditions

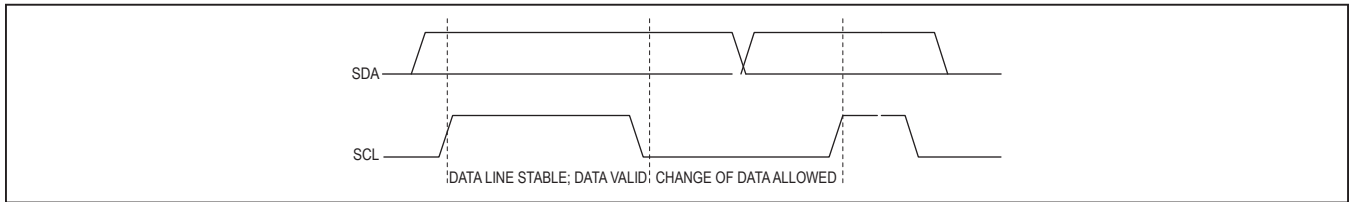

Figure 4. Bit Transfer

Any bytes received after the command byte are considered data bytes. The first data byte goes into the internal register of the MAX7300 selected by the command byte (Figure 8). If multiple data bytes are transmitted before a STOP condition is detected, these bytes are generally stored in subsequent MAX7300 internal registers because the command byte address generally autoincrements (Table 4).

Message Format for Reading

The MAX7300 is read using the MAX7300's internally stored command byte as address pointer, the same way the stored command byte is used as address pointer for

a write. The pointer generally autoincrements after each data byte is read using the same rules as for a write (Table 4). Thus, a read is initiated by first configuring the MAX7300's command byte by performing a write (Figure 7). The master can now read 'n' consecutive bytes from the MAX7300, with the first data byte being read from the register addressed by the initialized command byte (Figure 9). When performing read-after-write verification, remember to reset the command byte's address because the stored control byte address generally has been autoincremented after the write (Table 4). Table 5 is the register address map.

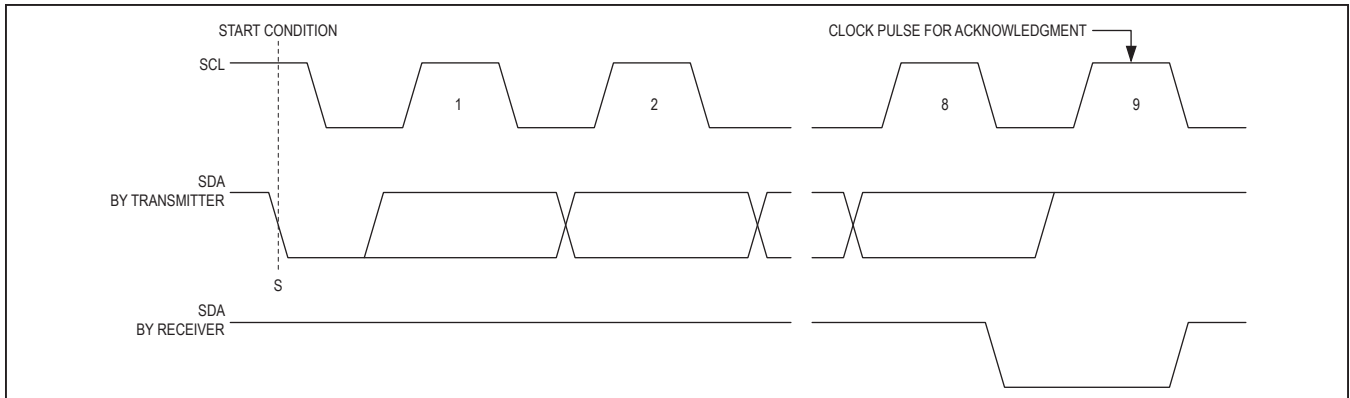

Figure 5. Acknowledge

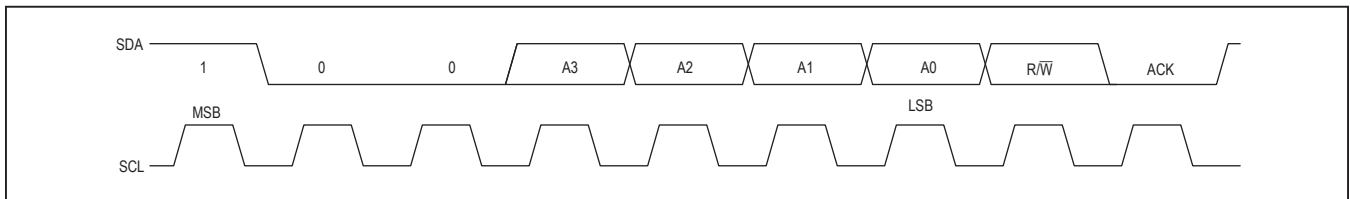

Figure 6. Slave Address

Operation with Multiple Masters

If the MAX7300 is operated on a 2-wire interface with multiple masters, a master reading the MAX7300 should use a repeated start between the write, which sets the MAX7300’s address pointer, and the read(s) that takes the data from the location(s). This is because it is possible for master 2 to take over the bus after master 1 has set up the MAX7300’s address pointer, but before master 1 has read the data. If master 2 subsequently changes, the MAX7300’s address pointer, then master 1’s delayed read can be from an unexpected location.

Command Address Autoincrementing

Address autoincrementing allows the MAX7300 to be configured with the shortest number of transmissions by minimizing the number of times the command address needs to be sent. The command address stored in the MAX7300 generally increments after each data byte is written or read (Table 4).

Initial Power-Up

On initial power-up, all control registers are reset and the MAX7300 enters shutdown mode (Table 6).

Transition (Port Data Change) Detection

Port transition detection allows any combination of the seven ports P24–P30 to be continuously monitored for changes in their logic status (Figure 10). A detected change is flagged on the transition detection mask register INT status bit, D7 (Table 10). If port P31 is configured as an output (Tables 1 and 2), then P31 also automatically becomes an active-high interrupt output (INT), which follows the condition of the INT status bit. Port P31 is set as output by writing bit D7 = 0 and bit D6 = 1 to the port configuration register (Table 1). Note that the MAX7300 does not identify which specific port(s) caused the interrupt, but provides an alert that one or more port levels have changed.

The mask register contains 7 mask bits that select which of the seven ports P24–P30 are to be monitored (Table 10). Set the appropriate mask bit to enable that port for transition detect. Clear the mask bit if transi-

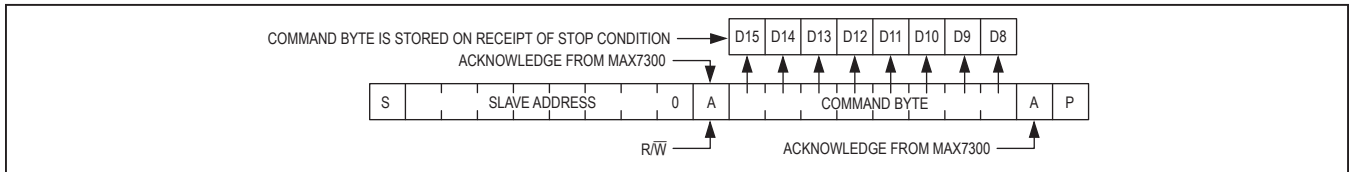

Figure 7. Command Byte Received

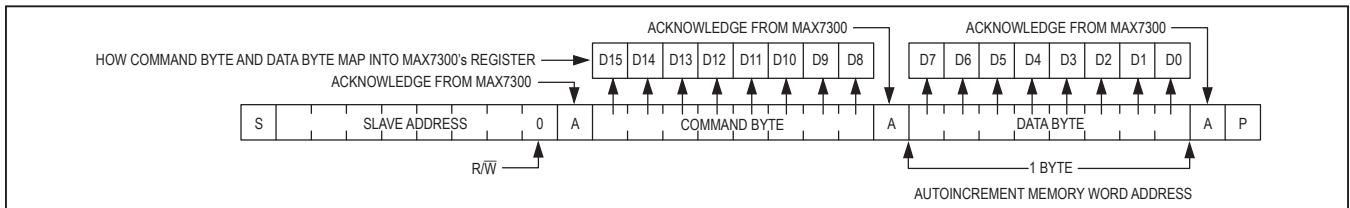

Figure 8. Command and Single Data Byte Received

tions on that port are to be ignored. Transition detection works regardless of whether the port being monitored is set to input or output, but generally, it is not particularly useful to enable transition detection for outputs.

To use transition detection, first set up the mask register and configure port P31 as an output, as described above. Then enable transition detection by setting the M bit in the configuration register (Table 9). Whenever the configuration register is written with the M bit set, the MAX7300 updates an internal 7-bit snapshot register, which holds the comparison copy of the logic states of ports P24 through P30. The update action occurs regardless of the previous state of the M bit, so that it is not necessary to clear the M bit and then set it again to update the snapshot register.

When the configuration register is written with the M bit set, transition detection is enabled and remains enabled until either the configuration register is written with the M bit clear, or a transition is detected. The INT status bit (transition detection mask register bit D7) goes low. Port P31 (if enabled as INT output) also goes low, if it was not already low.

Once transition detection is enabled, the MAX7300 continuously compares the snapshot register against the changing states of P24 through P31. If a change on any of the monitored ports is detected, even for a short time (like a pulse), the INT status bit (transition detection mask register bit D7) is set. Port P31 (if enabled as INT output) also goes high. The INT output and INT status bit are not cleared if more changes occur or if the data pattern returns to its original snapshot condition.

The only way to clear INT is to access (read or write) the transition detection mask register (Table 10). So if the transition detection mask register is read twice in succession after a transition event, the first time reads with bit D7 set (identifying the event), and the second time reads with bit D7 clear.

Transition detection is a one-shot event. When INT has been cleared after responding to a transition event, transition detection is automatically disabled, even though the M bit in the configuration register remains set (unless cleared by the user). Reenable transition detection by writing the configuration register with the M bit set to take a new snapshot of the seven ports P24 to P30.

External Component R_{ISET}

The MAX7300 uses an external resistor, R_{ISET}, to set internal biasing. Use a resistor value of 39kΩ.

Applications Information

Low-Voltage Operation

The MAX7300 operates down to 2V supply voltage (although the sourcing and sinking currents are not guaranteed), providing that the MAX7300 is powered up initially to at least 2.5V to trigger the device's internal reset.

Serial Interface Latency

When a MAX7300 register is written through the I²C interface, the register is updated on the rising edge of SCL during the data byte's acknowledge bit (Figure 5). The delay from the rising edge of SCL to the internal register being updated can range from 50ns to 350ns.

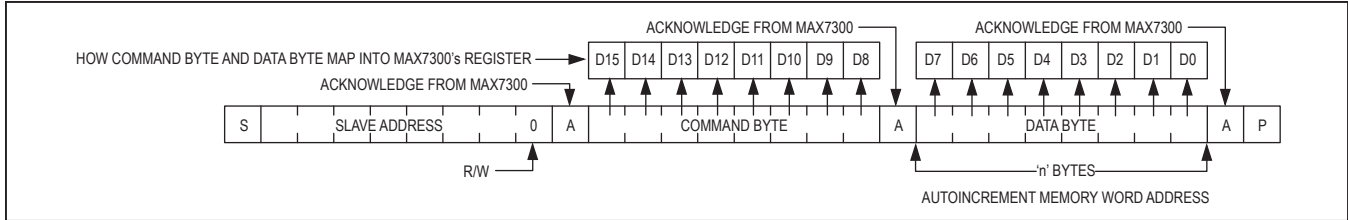

Figure 9. 'n' Data Bytes Received

Table 3. MAX7300 Address Map

| PIN CONNECTION | | DEVICE ADDRESS | | | | | | |
|----------------|-----|----------------|----|----|----|----|----|----|
| AD1 | AD0 | A6 | A5 | A4 | A3 | A2 | A1 | A0 |
| GND | GND | 1 | 0 | 0 | 0 | 0 | 0 | 0 |
| GND | V+ | 1 | 0 | 0 | 0 | 0 | 0 | 1 |
| GND | SDA | 1 | 0 | 0 | 0 | 0 | 1 | 0 |
| GND | SCL | 1 | 0 | 0 | 0 | 0 | 1 | 1 |
| V+ | GND | 1 | 0 | 0 | 0 | 1 | 0 | 0 |
| V+ | V+ | 1 | 0 | 0 | 0 | 1 | 0 | 1 |
| V+ | SDA | 1 | 0 | 0 | 0 | 1 | 1 | 0 |
| V+ | SCL | 1 | 0 | 0 | 0 | 1 | 1 | 1 |
| SDA | GND | 1 | 0 | 0 | 1 | 0 | 0 | 0 |
| SDA | V+ | 1 | 0 | 0 | 1 | 0 | 0 | 1 |
| SDA | SDA | 1 | 0 | 0 | 1 | 0 | 1 | 0 |
| SDA | SCL | 1 | 0 | 0 | 1 | 0 | 1 | 1 |
| SCL | GND | 1 | 0 | 0 | 1 | 1 | 0 | 0 |
| SCL | V+ | 1 | 0 | 0 | 1 | 1 | 0 | 1 |
| SCL | SDA | 1 | 0 | 0 | 1 | 1 | 1 | 0 |
| SCL | SCL | 1 | 0 | 0 | 1 | 1 | 1 | 1 |

Table 4. Autoincrement Rules

| COMMAND BYTE ADDRESS RANGE | AUTOINCREMENT BEHAVIOR |
|----------------------------|----------------------------------------------------------------|
| x0000000 to x1111110 | Command address autoincrements after byte read or written |
| x1111111 | Command address remains at x1111111 after byte written or read |

PC Board Layout Considerations

Ensure that all the MAX7300 GND connections are used. For TQFN versions, connect the underside exposed pad to GND. A ground plane is not necessary, but may be useful to reduce supply impedance if the MAX7300 outputs are to be heavily loaded. Keep the track length from the ISET pin to the R_{ISET} resistor as short as possible, and take the GND end of the register either to the ground plane or directly to the GND pins.

Power-Supply Considerations

The MAX7300 operates with power-supply voltages of 2.5V to 5.5V. Bypass the power supply to GND with a 0.047µF capacitor as close to the device as possible. Add a 1µF capacitor if the MAX7300 is far away from the board's input bulk decoupling capacitor.

Table 5. Register Address Map

| REGISTER | COMMAND ADDRESS | | | | | | | | HEX CODE |
|---------------------------------------------|-----------------|-----|-----|-----|-----|-----|----|----|----------|
| | D15 | D14 | D13 | D12 | D11 | D10 | D9 | D8 | |
| No-Op | X | 0 | 0 | 0 | 0 | 0 | 0 | 0 | 0x00 |
| Configuration | X | 0 | 0 | 0 | 0 | 1 | 0 | 0 | 0x04 |
| Transition Detect Mask | X | 0 | 0 | 0 | 0 | 1 | 1 | 0 | 0x06 |
| Factory Reserved; do not write to this port | X | 0 | 0 | 0 | 0 | 1 | 1 | 1 | 0x07 |
| Port Configuration P7, P6, P5, P4 | X | 0 | 0 | 0 | 1 | 0 | 0 | 1 | 0x09 |
| Port Configuration P11, P10, P9, P8 | X | 0 | 0 | 0 | 1 | 0 | 1 | 0 | 0x0A |
| Port Configuration P15, P14, P13, P12 | X | 0 | 0 | 0 | 1 | 0 | 1 | 1 | 0x0B |
| Port Configuration P19, P18, P17, P16 | X | 0 | 0 | 0 | 1 | 1 | 0 | 0 | 0x0C |
| Port Configuration P23, P22, P21, P20 | X | 0 | 0 | 0 | 1 | 1 | 0 | 1 | 0x0D |
| Port Configuration P27, P26, P25, P24 | X | 0 | 0 | 0 | 1 | 1 | 1 | 0 | 0x0E |
| Port Configuration P31, P30, P29, P28 | X | 0 | 0 | 0 | 1 | 1 | 1 | 1 | 0x0F |
| Port 0 only (virtual port, no action) | X | 0 | 1 | 0 | 0 | 0 | 0 | 0 | 0x20 |
| Port 1 only (virtual port, no action) | X | 0 | 1 | 0 | 0 | 0 | 0 | 1 | 0x21 |
| Port 2 only (virtual port, no action) | X | 0 | 1 | 0 | 0 | 0 | 1 | 0 | 0x22 |
| Port 3 only (virtual port, no action) | X | 0 | 1 | 0 | 0 | 0 | 1 | 1 | 0x23 |
| Port 4 only (data bit D0. D7-D1 read as 0) | X | 0 | 1 | 0 | 0 | 1 | 0 | 0 | 0x24 |
| Port 5 only (data bit D0. D7-D1 read as 0) | X | 0 | 1 | 0 | 0 | 1 | 0 | 1 | 0x25 |
| Port 6 only (data bit D0. D7-D1 read as 0) | X | 0 | 1 | 0 | 0 | 1 | 1 | 0 | 0x26 |
| Port 7 only (data bit D0. D7-D1 read as 0) | X | 0 | 1 | 0 | 0 | 1 | 1 | 1 | 0x27 |
| Port 8 only (data bit D0. D7-D1 read as 0) | X | 0 | 1 | 0 | 1 | 0 | 0 | 0 | 0x28 |
| Port 9 only (data bit D0. D7-D1 read as 0) | X | 0 | 1 | 0 | 1 | 0 | 0 | 1 | 0x29 |
| Port 10 only (data bit D0. D7-D1 read as 0) | X | 0 | 1 | 0 | 1 | 0 | 1 | 0 | 0x2A |
| Port 11 only (data bit D0. D7-D1 read as 0) | X | 0 | 1 | 0 | 1 | 0 | 1 | 1 | 0x2B |
| Port 12 only (data bit D0. D7-D1 read as 0) | X | 0 | 1 | 0 | 1 | 1 | 0 | 0 | 0x2C |
| Port 13 only (data bit D0. D7-D1 read as 0) | X | 0 | 1 | 0 | 1 | 1 | 0 | 1 | 0x2D |
| Port 14 only (data bit D0. D7-D1 read as 0) | X | 0 | 1 | 0 | 1 | 1 | 1 | 0 | 0x2E |
| Port 15 only (data bit D0. D7-D1 read as 0) | X | 0 | 1 | 0 | 1 | 1 | 1 | 1 | 0x2F |
| Port 16 only (data bit D0. D7-D1 read as 0) | X | 0 | 1 | 1 | 0 | 0 | 0 | 0 | 0x30 |
| Port 17 only (data bit D0. D7-D1 read as 0) | X | 0 | 1 | 1 | 0 | 0 | 0 | 1 | 0x31 |
| Port 18 only (data bit D0. D7-D1 read as 0) | X | 0 | 1 | 1 | 0 | 0 | 1 | 0 | 0x32 |
| Port 19 only (data bit D0. D7-D1 read as 0) | X | 0 | 1 | 1 | 0 | 0 | 1 | 1 | 0x33 |
| Port 20 only (data bit D0. D7-D1 read as 0) | X | 0 | 1 | 1 | 0 | 1 | 0 | 0 | 0x34 |
| Port 21 only (data bit D0. D7-D1 read as 0) | X | 0 | 1 | 1 | 0 | 1 | 0 | 1 | 0x35 |
| Port 22 only (data bit D0. D7-D1 read as 0) | X | 0 | 1 | 1 | 0 | 1 | 1 | 0 | 0x36 |
| Port 23 only (data bit D0. D7-D1 read as 0) | X | 0 | 1 | 1 | 0 | 1 | 1 | 1 | 0x37 |
| Port 24 only (data bit D0. D7-D1 read as 0) | X | 0 | 1 | 1 | 1 | 0 | 0 | 0 | 0x38 |
| Port 25 only (data bit D0. D7-D1 read as 0) | X | 0 | 1 | 1 | 1 | 0 | 0 | 1 | 0x39 |

Table 5. Register Address Map (continued)

| REGISTER | COMMAND ADDRESS | | | | | | | | HEX CODE |
|--------------------------------------------------|-----------------|-----|-----|-----|-----|-----|----|----|----------|
| | D15 | D14 | D13 | D12 | D11 | D10 | D9 | D8 | |
| Port 26 only (data bit D0. D7-D1 read as 0) | X | 0 | 1 | 1 | 1 | 0 | 1 | 0 | 0x3A |
| Port 27 only (data bit D0. D7-D1 read as 0) | X | 0 | 1 | 1 | 1 | 0 | 1 | 1 | 0x3B |
| Port 28 only (data bit D0. D7-D1 read as 0) | X | 0 | 1 | 1 | 1 | 1 | 0 | 0 | 0x3C |
| Port 29 only (data bit D0. D7-D1 read as 0) | X | 0 | 1 | 1 | 1 | 1 | 0 | 1 | 0x3D |
| Port 30 only (data bit D0. D7-D1 read as 0) | X | 0 | 1 | 1 | 1 | 1 | 1 | 0 | 0x3E |
| Port 31 only (data bit D0. D7-D1 read as 0) | X | 0 | 1 | 1 | 1 | 1 | 1 | 1 | 0x3F |
| 4 ports 4–7 (data bits D0–D3. D4–D7 read as 0) | X | 1 | 0 | 0 | 0 | 0 | 0 | 0 | 0x40 |
| 5 ports 4–8 (data bits D0–D4. D5–D7 read as 0) | X | 1 | 0 | 0 | 0 | 0 | 0 | 1 | 0x41 |
| 6 ports 4–9 (data bits D0–D5. D6–D7 read as 0) | X | 1 | 0 | 0 | 0 | 0 | 1 | 0 | 0x42 |
| 7 ports 4–10 (data bits D0–D6. D7 reads as 0) | X | 1 | 0 | 0 | 0 | 0 | 1 | 1 | 0x43 |
| 8 ports 4–11 (data bits D0–D7) | X | 1 | 0 | 0 | 0 | 1 | 0 | 0 | 0x44 |
| 8 ports 5–12 (data bits D0–D7) | X | 1 | 0 | 0 | 0 | 1 | 0 | 1 | 0x45 |
| 8 ports 6–13 (data bits D0–D7) | X | 1 | 0 | 0 | 0 | 1 | 1 | 0 | 0x46 |
| 8 ports 7–14 (data bits D0–D7) | X | 1 | 0 | 0 | 0 | 1 | 1 | 1 | 0x47 |
| 8 ports 8–15 (data bits D0–D7) | X | 1 | 0 | 0 | 1 | 0 | 0 | 0 | 0x48 |
| 8 ports 9–16 (data bits D0–D7) | X | 1 | 0 | 0 | 1 | 0 | 0 | 1 | 0x49 |
| 8 ports 10–17 (data bits D0–D7) | X | 1 | 0 | 0 | 1 | 0 | 1 | 0 | 0x4A |
| 8 ports 11–18 (data bits D0–D7) | X | 1 | 0 | 0 | 1 | 0 | 1 | 1 | 0x4B |
| 8 ports 12–19 (data bits D0–D7) | X | 1 | 0 | 0 | 1 | 1 | 0 | 0 | 0x4C |
| 8 ports 13–20 (data bits D0–D7) | X | 1 | 0 | 0 | 1 | 1 | 0 | 1 | 0x4D |
| 8 ports 14–21 (data bits D0–D7) | X | 1 | 0 | 0 | 1 | 1 | 1 | 0 | 0x4E |
| 8 ports 15–22 (data bits D0–D7) | X | 1 | 0 | 0 | 1 | 1 | 1 | 1 | 0x4F |
| 8 ports 16–23 (data bits D0–D7) | X | 1 | 0 | 1 | 0 | 0 | 0 | 0 | 0x50 |
| 8 ports 17–24 (data bits D0–D7) | X | 1 | 0 | 1 | 0 | 0 | 0 | 1 | 0x51 |
| 8 ports 18–25 (data bits D0–D7) | X | 1 | 0 | 1 | 0 | 0 | 1 | 0 | 0x52 |
| 8 ports 19–26 (data bits D0–D7) | X | 1 | 0 | 1 | 0 | 0 | 1 | 1 | 0x53 |
| 8 ports 20–27 (data bits D0–D7) | X | 1 | 0 | 1 | 0 | 1 | 0 | 0 | 0x54 |
| 8 ports 21–28 (data bits D0–D7) | X | 1 | 0 | 1 | 0 | 1 | 0 | 1 | 0x55 |
| 8 ports 22–29 (data bits D0–D7) | X | 1 | 0 | 1 | 0 | 1 | 1 | 0 | 0x56 |
| 8 ports 23–30 (data bits D0–D7) | X | 1 | 0 | 1 | 0 | 1 | 1 | 1 | 0x57 |
| 8 ports 24–31 (data bits D0–D7) | X | 1 | 0 | 1 | 1 | 0 | 0 | 0 | 0x58 |
| 7 ports 25–31 (data bits D0–D6. D7 reads as 0) | X | 1 | 0 | 1 | 1 | 0 | 0 | 1 | 0x59 |
| 6 ports 26–31 (data bits D0–D5. D6–D7 read as 0) | X | 1 | 0 | 1 | 1 | 0 | 1 | 0 | 0x5A |
| 5 ports 27–31 (data bits D0–D4. D5–D7 read as 0) | X | 1 | 0 | 1 | 1 | 0 | 1 | 1 | 0x5B |
| 4 ports 28–31 (data bits D0–D3. D4–D7 read as 0) | X | 1 | 0 | 1 | 1 | 1 | 0 | 0 | 0x5C |
| 3 ports 29–31 (data bits D0–D2. D3–D7 read as 0) | X | 1 | 0 | 1 | 1 | 1 | 0 | 1 | 0x5D |
| 2 ports 30–31 (data bits D0–D1. D2–D7 read as 0) | X | 1 | 0 | 1 | 1 | 1 | 1 | 0 | 0x5E |
| 1 port 31 only (data bits D0. D1–D7 read as 0) | X | 1 | 0 | 1 | 1 | 1 | 1 | 1 | 0x5F |

Note: Unused bits read as zero.

Table 6. Power-Up Configuration

| REGISTER FUNCTION | POWER-UP CONDITION | ADDRESS CODE (HEX) | REGISTER DATA | | | | | | | |
|----------------------------|---------------------------------------------------|--------------------|---------------|----|----|----|----|----|----|----|
| | | | D7 | D6 | D5 | D4 | D3 | D2 | D1 | D0 |
| Port Register Bits 4 to 31 | GPIO Output Low | 0x24 to 0x3F | X | X | X | X | X | X | X | 0 |
| Configuration Register | Shutdown Enabled Transition Detection Disabled | 0x04 | 0 | 0 | X | X | X | X | X | 0 |
| Input Mask Register | All Clear (Masked Off) | 0x06 | X | 0 | 0 | 0 | 0 | 0 | 0 | 0 |
| Port Configuration | P7, P6, P5, P4: GPIO Inputs without Pullup | 0x09 | 1 | 0 | 1 | 0 | 1 | 0 | 1 | 0 |
| Port Configuration | P11, P10, P9, P8: GPIO Inputs without Pullup | 0x0A | 1 | 0 | 1 | 0 | 1 | 0 | 1 | 0 |
| Port Configuration | P15, P14, P13, P12: GPIO Inputs without Pullup | 0x0B | 1 | 0 | 1 | 0 | 1 | 0 | 1 | 0 |
| Port Configuration | P19, P18, P17, P16: GPIO Inputs without Pullup | 0x0C | 1 | 0 | 1 | 0 | 1 | 0 | 1 | 0 |
| Port Configuration | P23, P22, P21, P20: GPIO Inputs without Pullup | 0x0D | 1 | 0 | 1 | 0 | 1 | 0 | 1 | 0 |
| Port Configuration | P27, P26, P25, P24: GPIO Inputs without Pullup | 0x0E | 1 | 0 | 1 | 0 | 1 | 0 | 1 | 0 |
| Port Configuration | P31, P30, P29, P28: GPIO Inputs without Pullup | 0x0F | 1 | 0 | 1 | 0 | 1 | 0 | 1 | 0 |

X = unused bits; if read, zero results.

Table 7. Configuration Register Format

| FUNCTION | ADDRESS CODE (HEX) | REGISTER DATA | | | | | | | |
|------------------------|-----------------------|---------------|----|----|----|----|----|----|----|
| | | D7 | D6 | D5 | D4 | D3 | D2 | D1 | D0 |
| Configuration Register | 0x04 | M | 0 | X | X | X | X | X | S |

Table 8. Shutdown Control (S Data Bit D0) Format

| FUNCTION | ADDRESS CODE (HEX) | REGISTER DATA | | | | | | | |
|------------------|-----------------------|---------------|----|----|----|----|----|----|----|
| | | D7 | D6 | D5 | D4 | D3 | D2 | D1 | D0 |
| Shutdown | 0x04 | M | 0 | X | X | X | X | X | 0 |
| Normal Operation | 0x04 | M | 0 | X | X | X | X | X | 1 |

Table 9. Transition Detection Control (M Data Bit D7) Format

| FUNCTION | ADDRESS CODE (HEX) | REGISTER DATA | | | | | | | |
|----------|-----------------------|---------------|----|----|----|----|----|----|----|
| | | D7 | D6 | D5 | D4 | D3 | D2 | D1 | D0 |
| Disabled | 0x04 | 0 | 0 | X | X | X | X | X | S |
| Enabled | 0x04 | 1 | 0 | X | X | X | X | X | S |

Table 10. Transition Detection Mask Register

| FUNCTION | REGISTER ADDRESS (HEX) | READ/ WRITE | REGISTER DATA | | | | | | | |
|------------------|------------------------------|----------------|---------------|------------|------------|------------|------------|------------|------------|------------|
| | | | D7 | D6 | D5 | D4 | D3 | D2 | D1 | D0 |
| Mask Register | 0x06 | Read | INT Status* | Port 30 | Port 29 | Port 28 | Port 27 | Port 26 | Port 25 | Port 24 |
| | | Write | Unchanged | mask | mask | mask | mask | mask | mask | mask |

*INT is automatically cleared after it is read.

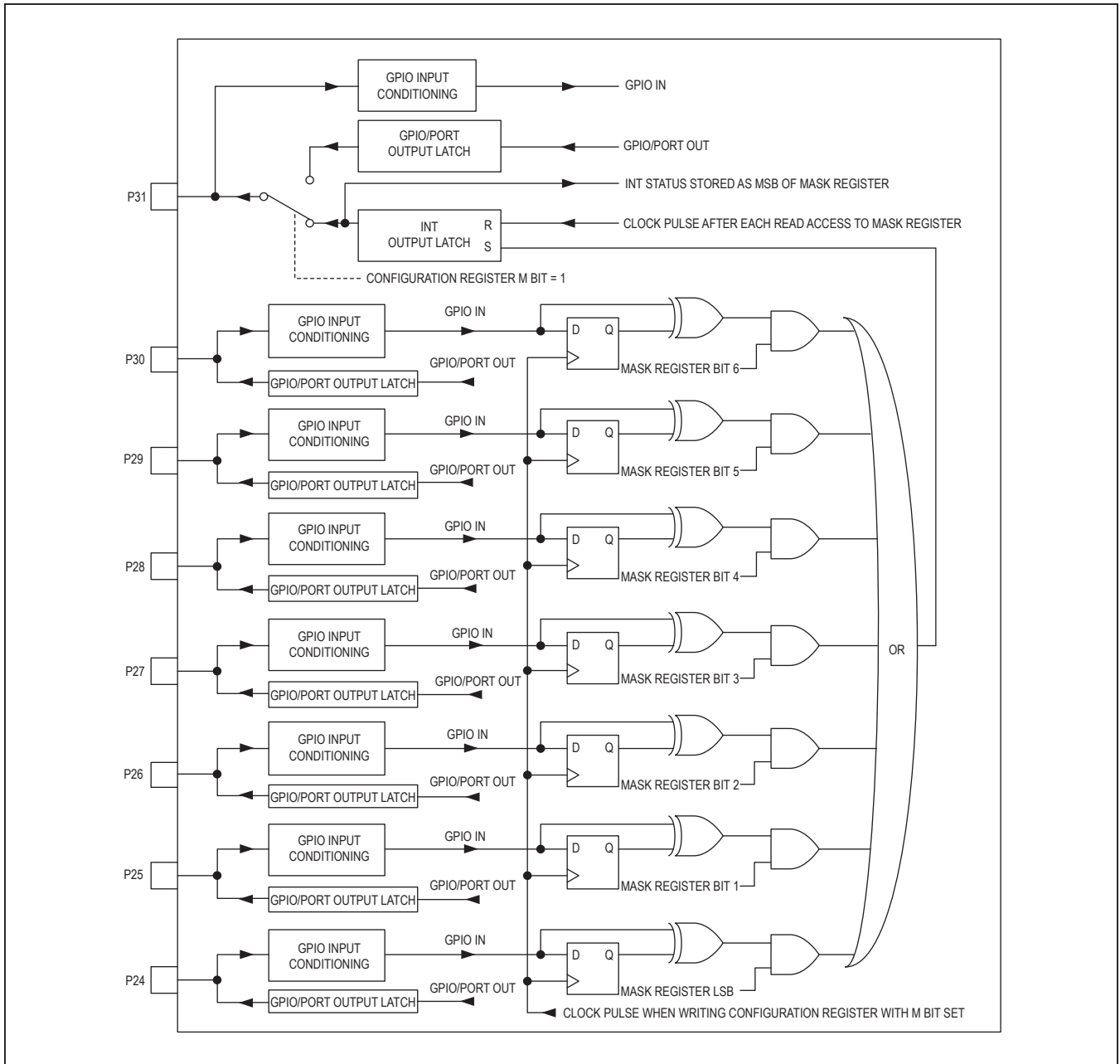
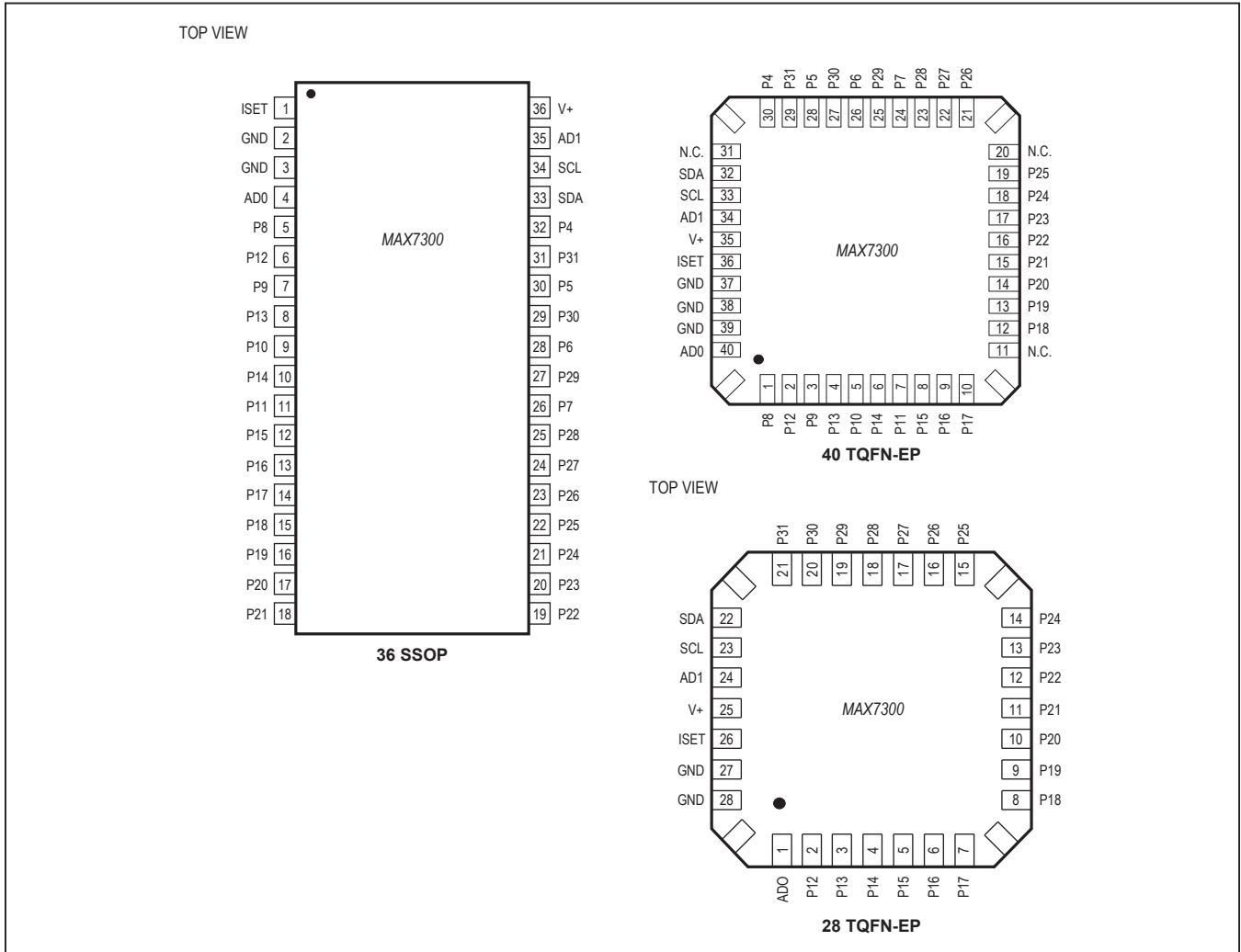

Figure 10. Maskable GPIO Ports P24 to P31

Pin Configurations (continued)



Chip Information

PROCESS: CMOS

Package Information

For the latest package outline information and land patterns (footprints), go to www.maximintegrated.com/packages. Note that a "+", "#", or "-" in the package code indicates RoHS status only. Package drawings may show a different suffix character, but the drawing pertains to the package regardless of RoHS status.

| PACKAGE TYPE | PACKAGE CODE | OUTLINE NO. | LAND PATTERN NO. |
|--------------|--------------|-------------------------|-------------------------|
| 28 SSOP | A28+1 | 21-0056 | 90-0095 |
| 28 TQFN-EP | T2855+6 | 21-0140 | 90-0026 |
| 36 SSOP | A36+4 | 21-0040 | 90-0098 |
| 40 TQFN-EP | T4066+5 | 21-0141 | 90-0055 |