



MAX7314 Evaluation Kit

Evaluates: MAX7314

General Description

The MAX7314 evaluation kit (EV kit) is a fully assembled and tested surface-mount, 16-output LED driver printed-circuit board (PCB.) The circuit uses the MAX7314 IC, an 18-port GPIO with LED intensity control, interrupt, and hot-insertion protection. The EV kit includes four RGB LEDs and four white LEDs (WLEDs) that can be controlled simultaneously by the MAX7314. The EV kit demonstrates the MAX7314 IC's 8-bit PWM LED intensity control, two-phase LED blinking, reset, interrupt output, and unique single-pin, one-of-four I²C or 2-wire address features.

The MAX7314 EV kit also demonstrates the BLINK feature and includes a configurable oscillator circuit. The EV kit can also be reconfigured for evaluating a relay.

The MAX7314 EV kit provides PCB pads for the MAX7314 2-wire serial interface signals. A Windows 2000/XP/Vista®-compatible software is provided to access the MAX7314 IC. The MAX7314 EV kit can also be directly interfaced to a user-provided 2-wire system.

Features

- ◆ Evaluates Four RGB and Four White LEDs
- ◆ Independent Output Control of Each LED
- ◆ Demonstrates Unique Single-Pin, One-of-Four 2-Wire Addressing
- ◆ Relay Driving Capable
- ◆ PC Interface or User 2-Wire System Interface
- ◆ Windows 2000/XP/Vista (32-Bit)-Compatible Software
- ◆ USB Powered
- ◆ Surface-Mount Components
- ◆ Fully Assembled and Tested

Ordering Information

| PART | TYPE |
|---------------|---------|
| MAX7314EVKIT+ | EV Kit* |

+Denotes lead-free and RoHS-compliant.

*A high-speed A-to-B USB cable is provided with the EV kit.

Component List

| DESIGNATION | QTY | DESCRIPTION |
|------------------|-----|--|
| C1, C12, C14, | 3 | 10µF ±10%, 16V X5R ceramic capacitors (0805) Murata GRM21BR61C106K KEMET C0805C106K4PACTU |
| C2, C3 | 2 | 22pF ±5%, 50V C0G ceramic capacitors (0603) Murata GRM1885C1H220J TDK C1608C0G1H220J |
| C4 | 1 | 0.033µF ±10%, 16V X7R ceramic capacitor (0603) Murata GRM188R71C333K Taiyo Yuden EMK107BJ333KA (X5R) |
| C5–C10, C17, C18 | 8 | 0.1µF ±10%, 16V X7R ceramic capacitors (0603) Murata GRM188R71C104K TDK C1608X7R1C104K |
| C11, C13 | 2 | 1µF ±10%, 16V X5R ceramic capacitors (0603) Murata GRM188R61C105K TDK C1608X5R1C105K |

| DESIGNATION | QTY | DESCRIPTION |
|-------------|-----|--|
| C15, C16 | 2 | 10pF ±5%, 50V C0G ceramic capacitors (0603) Murata GRM1885C1H100J TDK C1608C0G1H100J |
| C19 | 1 | 47µF, 10V, low-ESR POSCAP (C) SANYO 10TPB47MC |
| C20 | 1 | 1µF ±10%, 6.3V X5R ceramic capacitor (0603) Murata GRM188R60J105KA AVX 06036D105KA Taiyo Yuden JMK107BJ105KA |
| C21 | 1 | 4.7µF ±10%, 6.3V X5R ceramic capacitor (0805) Murata GRM21BR60J475KA AVX 08056D475KA or Taiyo Yuden JMK212BJ475KG |
| C22, C24 | 2 | 0.1µF ±10%, 16V X7R ceramic capacitors (0603) Murata GRM188R71C104K |

Windows Vista is a registered trademark of Microsoft Corp.



Maxim Integrated Products 1

For pricing, delivery, and ordering information, please contact Maxim Direct 1-888-629-4642, or visit Maxim's website at www.maxim-ic.com.

MAX7314 Evaluation Kit

Component List (continued)

| DESIGNATION | QTY | DESCRIPTION |
|-----------------------------|-----|--|
| C23 | 1 | 10 μ F \pm 20%, 6.3V X5R ceramic capacitor (0603) Murata GRM188R60J106M TDK C1608X5R0J106M |
| D1–D4 | 4 | RGB LEDs (2.8mm x 3.2mm) |
| D5–D8 | 4 | White LEDs (PLCC-2) |
| D9 | 1 | Green LED (0603) |
| FB1 | 1 | Ferrite bead (0603) TDK MMZ1608R301A |
| H1 | 0 | Not installed, 2 x 5-pin JTAG header |
| JU1, JU3, JU8, JU9, JU10 | 0 | Not installed, 3-pin headers |
| JU2 | 1 | 5-pin header, 0.100in center |
| JU4, JU5 | 2 | 2-pin headers, 0.100in centers |
| JU6, JU7 | 0 | Not installed, 2-pin headers |
| JU11 | 1 | 3-pin header, 0.100in center |
| P1 | 1 | USB series B right-angle PC mount receptacle |
| R1, R2 | 2 | 27 Ω \pm 5% resistors (0603) |
| R3, R35, R36, R37 | 4 | 1.5k Ω \pm 5% resistors (0603) |
| R4 | 1 | 470 Ω \pm 5% resistor (0603) |
| R5 | 1 | 2.2k Ω \pm 5% resistor (0603) |
| R6, R34 | 2 | 10k Ω \pm 5% resistors (0603) |
| R7 | 1 | 169k Ω \pm 1% resistor (0603) |
| R8 | 1 | 100k Ω \pm 1% resistor (0603) |
| R9–R13 | 0 | Not installed, resistors shorted by PCB trace (0402) |
| R14 | 1 | 220 Ω \pm 5% resistor (0603) |
| R15–R18 | 4 | 56 Ω \pm 5% resistors (0603) |
| R19, R22, R25, R28 | 4 | 68 Ω \pm 5% resistors (0603) |

| DESIGNATION | QTY | DESCRIPTION |
|-----------------------|-----|---|
| R20, R23, R26, R29 | 4 | 120 Ω \pm 5% resistors (0603) |
| R21, R24, R27, R30 | 4 | 130 Ω \pm 5% resistors (0603) |
| R31, R32 | 2 | 165k Ω \pm 1% resistors (0603) |
| R33 | 1 | 82.5k Ω \pm 1% resistor (0603) |
| SW1 | 1 | SPST momentary-contact switch |
| TP12–TP15 | 4 | Multipurpose test points |
| U1 | 1 | 18-port GPIO with LED intensity control (24 QSOP) Maxim MAX7314AEG+ |
| U2, U3 | 2 | TinyLogic HS inverters with Schmitt trigger inputs (5 SC70) Fairchild NC7S14P5X (Top Mark: S14) |
| U4 | 1 | Microcontroller (68 QFN-EP*) Maxim MAXQ2000-RAX+ |
| U5 | 1 | LDO regulator (5 SC70) Maxim MAX8511EXK25+ |
| U6 | 1 | Adjustable-output LDO regulator (5 SC70) Maxim MAX8512EXK+ |
| U7 | 1 | UART-to-USB converter (32 TQFP) FTDI FT232BL |
| U8 | 1 | 93C46 type 3-wire EEPROM (8 SO) Atmel AT93C46A-10SU-2.7 |
| Y1 | 1 | 16MHz crystal |
| Y2 | 1 | 6MHz crystal |
| — | 3 | Shunts |
| — | 1 | PCB: MAX7314 Evaluation Kit+ |

*EP = Exposed pad.

Component Suppliers

| SUPPLIER | PHONE | WEBSITE |
|--|--------------|-----------------------------|
| AVX Corp. | 843-946-0238 | www.avxcorp.com |
| Fairchild Semiconductor | 888-522-5372 | www.fairchildsemi.com |
| Murata Electronics North America, Inc. | 770-436-1300 | www.murata-northamerica.com |
| SANYO Electric Co., Ltd. | 619-661-6835 | www.sanyodevice.com |
| Taiyo Yuden | 800-348-2496 | www.t-yuden.com |
| TDK Corp. | 847-803-6100 | www.component.tdk.com |

Note: Indicate that you are using the MAX7314 when contacting these component suppliers.

MAX7314 Evaluation Kit

Evaluates: MAX7314

Quick Start

Required Equipment

Before beginning, the following equipment is needed:

- MAX7314EVKIT+ (USB cable included)
- Windows 2000/XP/Vista PC with a spare USB port

Note: In the following sections, software-related items are identified by bolding. Text in **bold** refers to items directly from the EV kit software. Text in **bold and underlined** refers to items from the Windows operating system.

Procedure

The MAX7314 EV kit is fully assembled and tested. Follow the steps below to verify board operation:

- 1) Visit www.maxim-ic.com/evkitsoftware to download the latest version of the MAX7314 EV kit software. Save the EV kit software to a temporary folder and uncompress the ZIP file, 7314Rxx.ZIP.
- 2) Install the EV kit software on your computer by running the INSTALL.EXE program inside the temporary folder. The program files are copied and icons are created in the Windows **Start | Programs** menu.
- 3) Verify that a shunt is installed on pins 1-3 of jumper JU2 (0x40 address).
- 4) Verify that a shunt is installed on jumpers JU4 and JU5 (3Hz blink rate).
- 5) Connect the USB cable from the PC to the EV kit board. A **Building Driver Database** window pops up in addition to a **New Hardware Found** message when installing the USB driver for the first time. If you do not see a window that is similar to the one described above after 30s, remove the USB cable from the board and reconnect it. Administrator privileges are required to install the USB device driver on Windows 2000/XP/Vista.
- 6) Follow the directions of the **Add New Hardware Wizard** to install the USB device driver. Choose the **Search for the best driver for your device** option. Specify the location of the device driver to be **C:\Program Files\MAX7314** (default installation directory) using the **Browse** button. During device driver installation, Windows might show a warning message indicating that the device driver Maxim uses does not contain a digital signature. This is not an error condition and it is safe to proceed with installation. Refer to the document USB_Driver_Help.PDF for additional information.
- 7) Start the EV kit software by opening its icon in the **Start | Programs** menu. The EV kit software main window should appear as shown in Figure 1.

See the *Detailed Description of Software* section for more information on the MAX7314 EV kit software operation.

Detailed Description of Hardware

The MAX7314 EV kit demonstrates the MAX7314 18-port GPIO with LED intensity control. The EV kit utilizes the device's 16 GPIO ports to drive four RGB LEDs and four WLEDs. The device's output-only pin ($\overline{INT}/16$) is used as an interrupt output and the input-only pin (BLINK) is used for blink control. In addition, the EV kit provides a relay interface (JU7), a configurable BLINK oscillator, and the ability to evaluate four of the 16 GPIO ports as inputs (P12–P15). The LEDs can be controlled independently and their intensity varied using the appropriate MAX7314 8-bit PWM control register. The device's two-phase LED blink control feature and unique single-pin, one-of-four 2-wire address feature can also be evaluated. The device requires 3.3V for operation and is powered by the EV kit circuit's V+ rail.

The blink feature is demonstrated using a configurable oscillator circuit. The oscillator circuit comprises two logic inverters (U2, U3), one capacitor (C23), and three resistors (R31, R32, and R33). By configuring jumpers JU4 and JU5, blink frequencies of 0.7Hz to 3.0Hz can be evaluated. A BLINK_IN PCB pad is provided for connecting to an external square-wave generator. Jumper JU6 is used to disable and power down both inverters, disabling the on-board oscillator.

The MAX7314 EV kit provides SCL and SDA PCB pads for the 2-wire serial interface signals. These pads can be connected directly to a user-provided 2-wire system that has pullup resistors for the SCL and SDA signals. Jumper JU2 is used to configure the MAX7314 IC's 2-wire address and demonstrates the IC's unique single-pin, one-of-four 2-wire address feature. A PCB pad is also provided for the MAX7314 AD0 pin. See Table 2 for additional information.

Jumper and Switch Functions

Several jumper selections and a reset switch function provided by the MAX7314 EV kit are presented in Tables 1–8.

EV Kit Circuit V+ Source

The MAX7314 EV kit provides jumper JU1 to select the source for the V+ rail of the EV kit circuit. By default, the V+ rail is set to 3.3V, which is supplied by the interface circuit. Alternatively, the EV kit's VDD pad can be used to supply 3.3V to the circuit's V+ rail. The interface circuit is powered through a PC's USB port. Table 1 lists the various jumper options for powering the circuit's V+ rail.

MAX7314 Evaluation Kit

Table 1. JU1 Configuration

| SHUNT POSITION | MAX7314 V+ PIN | EV KIT 3.3V SUPPLY SOURCE |
|----------------|--|---------------------------|
| 1-2* | Connected to 3.3V | Interface circuit |
| 2-3 | Connected to the VDD pad (cut the trace between pins 1-2 before shorting pins 1-2) | External supply |

*Default position.

MAX7314 2-Wire Serial Address

The MAX7314 EV kit provides a jumper (JU2) for configuring the 2-wire serial address of the MAX7314. The SCL, SDA, and AD0 PCB pads are provided for interfacing to the 2-wire serial address bus and configuring the address, respectively. Table 2 lists the various jumper options for configuring the 2-wire address.

Table 2. JU2 Configuration

| SHUNT POSITION | MAX7314 AD0 PIN | MAX7314 2-WIRE ADDRESS |
|----------------|----------------------|------------------------|
| 1-3* | Connected to GND | 0x40 |
| 1-2 | Connected to V+ | 0x48 |
| 1-4 | Connected to SCL | 0xC0 |
| 1-5 | Connected to SDA | 0xC8 |
| Not installed | Connected to AD0 pad | Externally set |

*Default position.

BLINK Signal Source

The MAX7314 EV kit provides a jumper (JU3) to select the BLINK pin's signal source: the EV kit's oscillator (U2, U3), or a user-provided CMOS square-wave signal. The square-wave signal is applied across the EV kit's BLINK_IN and GND board pads. Table 3 lists the various jumper JU3 options for the BLINK signal source.

Table 3. JU3 Configuration

| SHUNT POSITION | MAX7314 BLINK PIN | MAX7314 BLINK SOURCE |
|----------------|---|--------------------------------------|
| 1-2* | Connected to OSC | EV kit oscillator** |
| 2-3 | Connected to the BLINK_IN pad (cut the trace between pins 1-2 before shorting pins 1-2) | External CMOS square-wave oscillator |

*Default position.

**See Table 4 for configuring the oscillator frequency.

Oscillator Frequency Selection and Enable

The MAX7314 EV kit features jumpers JU4 and JU5 to set the EV kit's oscillator frequency (from 0.7Hz to 3.0Hz). Additionally, jumper JU6 is provided to disable the EV kit's oscillator. Table 4 lists the various frequency selection options using jumpers JU4 and JU5. Table 5 lists jumper JU6 enable/disable options for inverters U2 and U3.

Table 4. JU4, JU5 Configuration

| SHUNT POSITION (JU4) | SHUNT POSITION (JU5) | OSCILLATOR FREQUENCY (Hz) |
|----------------------|----------------------|---------------------------|
| Not installed | Not installed | 0.70 |
| Installed | Not installed | 1.50 |
| Not installed | Installed | 2.23 |
| Installed | Installed | 3.00* |

*Default position.

Table 5. JU6 Configuration

| SHUNT POSITION | U2/U3 VCC PIN | OSCILLATOR OPERATION |
|------------------------------|-----------------|-----------------------|
| Installed* (pc short) | Connected to V+ | Enabled |
| Not installed (cut pc short) | Floating | Disabled, not powered |

*Default position.

Reset Control Methods

The EV kit provides a switch (SW1) to reset the MAX7314 IC. Additionally, the EV kit provides a \overline{RST} PCB pad for using an external controller to reset the device. Refer to the MAX7314 IC data sheet for additional functions of the \overline{RST} pin.

Table 6. SW1 Functions

| SWITCH STATE | MAX7314 \overline{RST} PIN | MAX7314 STATE |
|--------------|------------------------------|--------------------|
| Not pressed | Connected to V+ through R34 | Normal operation |
| Pressed | Connected to GND through SW1 | Reset to POR state |

MAX7314 Evaluation Kit

Evaluates: MAX7314

I²C Interface

The EV kit allows for evaluating the MAX7314 with the on-board I²C interface or a user-supplied I²C interface. This is accomplished by configuring jumpers JU1, JU8, JU9, and JU10 accordingly.

On-board interface:

- 1) Configure jumpers JU8, JU9, and JU10 according to Table 7.
- 2) Configure jumper JU1 with a shunt on pins 1-2 (see Table 1.).
- 3) Configure jumper JU11 according to Table 8.

User-supplied interface:

- 1) Configure jumpers JU8, JU9, and JU10 according to Table 7.
- 2) Cut trace between pins 1-2 of jumper JU1 and place a shunt on pins 2-3 of JU1.
- 3) Cut trace between pins 1-2 of jumper JU11 and place a shunt on pins 2-3 of JU11.
- 4) Connect the $\overline{\text{INT}}$ pad to an interrupt handling pin on the user-supplied interface.
- 5) Connect the SDA and SCL lines from the user-supplied interface to the SDA and SCL pads.
- 6) Connect the I/O supply voltage of the user-supplied interface across the VDD and GND pads.

When evaluating the EV kit with a user-supplied interface, ensure that the SCL, SDA, and $\overline{\text{INT}}$ lines are pulled up to the I/O supply voltage through appropriate pullup resistors. When using the on-board I²C interface, 1.5k Ω pullup resistors (R35, R36, R37) are provided on each of the SCL, SDA, and $\overline{\text{INT}}$ lines.

Table 7. JU8, JU9, and JU10 Configuration

| SHUNT POSITION (JU8) | SHUNT POSITION (JU9) | SHUNT POSITION (JU10) | I ² C INTERFACE |
|----------------------|----------------------|-----------------------|---|
| 1-2* | 1-2* | 1-2* | On board |
| 2-3 | 2-3 | 2-3 | User-supplied (cut the trace between pins 1-2 of JU8, JU9, JU10 before shorting pins 2-3 of JU8, JU9, JU10) |

*Default position.

LED Supply

The EV kit provides two options for powering the on-board LEDs. Jumper JU11 connects the LEDs to the 5V (typ) supply from the PC's USB port or to an external supply voltage connected to the VLED pad. When evaluating the EV kit with a user-supplied I²C interface, an external supply must be used to power the on-board LEDs. Table 8 lists the LED supply voltage options.

Table 8. JU11 Configuration

| SHUNT POSITION | LED SUPPLY VOLTAGE |
|----------------|---|
| 1-2* | PC's USB port |
| 2-3 | External supply (cut the trace between pins 1-2 before shorting pins 2-3) |

*Default position.

Evaluating Device Inputs

The EV kit provides test points TP12–TP15 to allow for the use of the P12–P15 pins as input ports. The P0–P11 pins can be configured as inputs, but are only utilized as outputs on the MAX7314 EV kit. To utilize the P12–P15 pins as inputs, configure the EV kit as follows:

- 1) Uninstall the pin's associated WLED.
- 2) Uninstall the pin's associated resistor and replace with a short or 0 Ω resistor.
- 3) Connect the input signal to the pin's associated test point.
- 4) See the *Port Configuration* section for details on configuring the P12–P15 pins as input ports.

Table 9. P12–P15 Pin Components

| PIN | WLED | RESISTOR | TEST POINT |
|-----|------|----------|------------|
| P12 | D5 | R18 | TP12 |
| P13 | D6 | R17 | TP13 |
| P14 | D7 | R16 | TP14 |
| P15 | D8 | R15 | TP15 |

Relay Evaluation

The EV kit circuit can also be reconfigured for evaluating a 5V-rated relay by using jumper JU7. White LED D5 and resistor R5 must be removed and a short placed across resistor R5 pads. The MAX7314 can sink up to 50mA on the output.

MAX7314 Evaluation Kit

___ Detailed Description of Software

Note: Words in **boldface** are user-selectable features in the MAX7314 EV kit software. A mouse or the keyboard's tab key is used to navigate various items on the main window.

The MAX7314 EV kit software features four window tabs: **Global and White LED Config/Status**, **RGB LED Config/Status**, **Port Configuration**, and **Port Status**. Each tab provides a mixture of controls and labels to facilitate the evaluation of the MAX7314 EV kit. Additional controls are also provided on the software's main window and in the menu bar.

The MAX7314 EV kit software configures the 2-wire communication speed to 400kHz by default. The speed can be reduced to 100kHz if required, by selecting **View | 2-Wire Speed | 100kHz** from the menu bar. This configuration might be required if slower 2-wire devices are connected to the EV kit's SCL and SDA pads. Once the EV kit has been detected, the software continues to poll the interface, reverifying device connectivity. To disable device polling, deselect the **Options | Poll U1** menu item.

The main window's status bar provides connection and communication information. The left section of the status bar provides the current connection status between the PC and EV kit. The right section of the status bar provides communication status in regards to sending and receiving data to and from the MAX7314 IC.

The software has a demo mode that is accessible by selecting the **Options | Demo Mode** menu item. When in demo mode, all software communication with the EV kit hardware is disabled. This feature enables a user to evaluate the software without hardware connectivity.

Software Startup

Upon starting the program, the MAX7314 EV kit software establishes a connection with the EV kit's on-board interface and automatically detects the U1 serial address. Once a connection has been made, the software initializes the MAX7314 IC and starts up with the **Global and White LED Config/Status** tab sheet selected (see Figure 1). When initialized, the IC is configured to operate with ports P0–P15 as outputs and port $\overline{\text{INT}}$ /O16 as an interrupt output. Table 10 lists the initialized state of the device registers.

Table 10. Initial Configuration

| REGISTER | INITIALIZE CONDITION | REGISTER DATA |
|---|---|---------------|
| Blink Phase 0 Outputs P7–P0 | Outputs low | 0x00 |
| Blink Phase 0 Outputs P15–P8 | Outputs low | 0x00 |
| Ports Configuration P7–P0 | Outputs | 0x00 |
| Ports Configuration P15–P8 | Outputs | 0x00 |
| Blink Phase 1 Outputs P7–P0 | High-impedance outputs | 0xFF |
| Blink Phase 1 Outputs P15–P8 | High-impedance outputs | 0xFF |
| Master, O16 Intensity | PWM oscillator is enabled; master intensity is 1/15; O16 intensity is 8/16* | 0x17 |
| Configuration | $\overline{\text{INT}}$ /O16 is an interrupt output; blink is disabled; global intensity is enabled | 0x0C |
| Outputs Intensity P1, P0 . . . Outputs Intensity P15, P14 | PWM outputs (intensity duty cycle is 8/16) | 0x77 |

*See the *Global Configuration/Status* section.

MAX7314 Evaluation Kit

Evaluates: MAX7314

Software Reset

The MAX7314 can be returned to its power-on-reset (POR) state by selecting **File | Reset** from the menu bar. After a reset has been performed, ports P0–P11 are configured as inputs. This is reflected on the software's **Port Configuration** and **Port Status** tab sheets. Although the P0–P11 ports are configured as inputs on reset, the EV kit is designed to operate with P0–P11 as output-only ports. Pressing the **Configure** button on the **Port Configuration** tab configures the P0–P11 ports as outputs. Refer to the MAX7314 IC data sheet for details on the device's power-up configuration.

Global and White LED Config/Status

The **Global and White LED Config/Status** tab sheet contains two group boxes. The **Global Configuration/Status** group box is used to enable/disable various MAX7314 global functions. The **White LED/Flash Configuration** group box is used to configure the

WLED output ports, as well as provide flash capability. See the *Global Configuration/Status* and *White LED/Flash Configuration* sections for details on each group box's controls.

Global Configuration/Status

The **Global Configuration/Status** group box provides controls to configure global device settings: blink enable, blink flip, and LED intensity control. The **Static Outputs** and **Global Intensity Control** checkboxes are used to set the desired LED intensity control scheme. The **Master Intensity** and **Global Intensity** track bars are used to configure the desired LED intensity. See Table 11 for details on configuring the device for one of the three intensity control schemes. When configured for static and PWM outputs, see the *White LED/Flash Configuration* and *RGB LED Config/Status* sections for more details. Refer to the MAX7314 IC data sheet for additional LED intensity control details.

Table 11. Intensity Control Scheme

| CONFIGURATION | STATIC OUTPUTS CHECKBOX | MASTER INTENSITY TRACK BAR | GLOBAL INTENSITY CONTROL CHECKBOX | GLOBAL INTENSITY TRACK BAR |
|------------------------|-------------------------------------|----------------------------------|-------------------------------------|----------------------------------|
| Static Outputs | <input checked="" type="checkbox"/> | Disabled. Set at 0/15. | X | X |
| PWM Outputs | <input type="checkbox"/> | Enabled. Set from 1/15 to 15/15. | <input checked="" type="checkbox"/> | Enabled. Set from 1/16 to 16/16. |
| Static and PWM Outputs | <input type="checkbox"/> | Enabled. Set from 1/15 to 15/15. | <input type="checkbox"/> | Disabled. |

X = Don't care.

MAX7314 Evaluation Kit

White LED/Flash Configuration

The **White LED/Flash Configuration** group box is used to turn the EV kit's WLEDs (D5–D8) on and off, adjust WLED intensity, and provide control of all four WLEDs as a single flash unit. The **Phase 0** and **Phase 1** checkboxes are used to set or clear the respective bit in that Blink Phase register. When checked, the associated output port is set low, turning the respective WLED on. When unchecked, the associated output port is high impedance. The **WLED Intensity** track bar inde-

pendently controls the intensity of all WLEDs (D5–D8). Refer to the MAX7314 IC data sheet for additional intensity setting details.

Flash features such as **Single Flash**, **Repeat Flash**, and time delays from **0.5s to 8s** duration can be selected. To utilize the flash feature, the **Enable Flash Timer** checkbox must be checked. Pressing the **Run Flash** button initiates the flash sequence. The **Single Flash**, **Repeat Flash**, and flash timer settings can be changed on the fly. When running the flash, all global **BLINK**

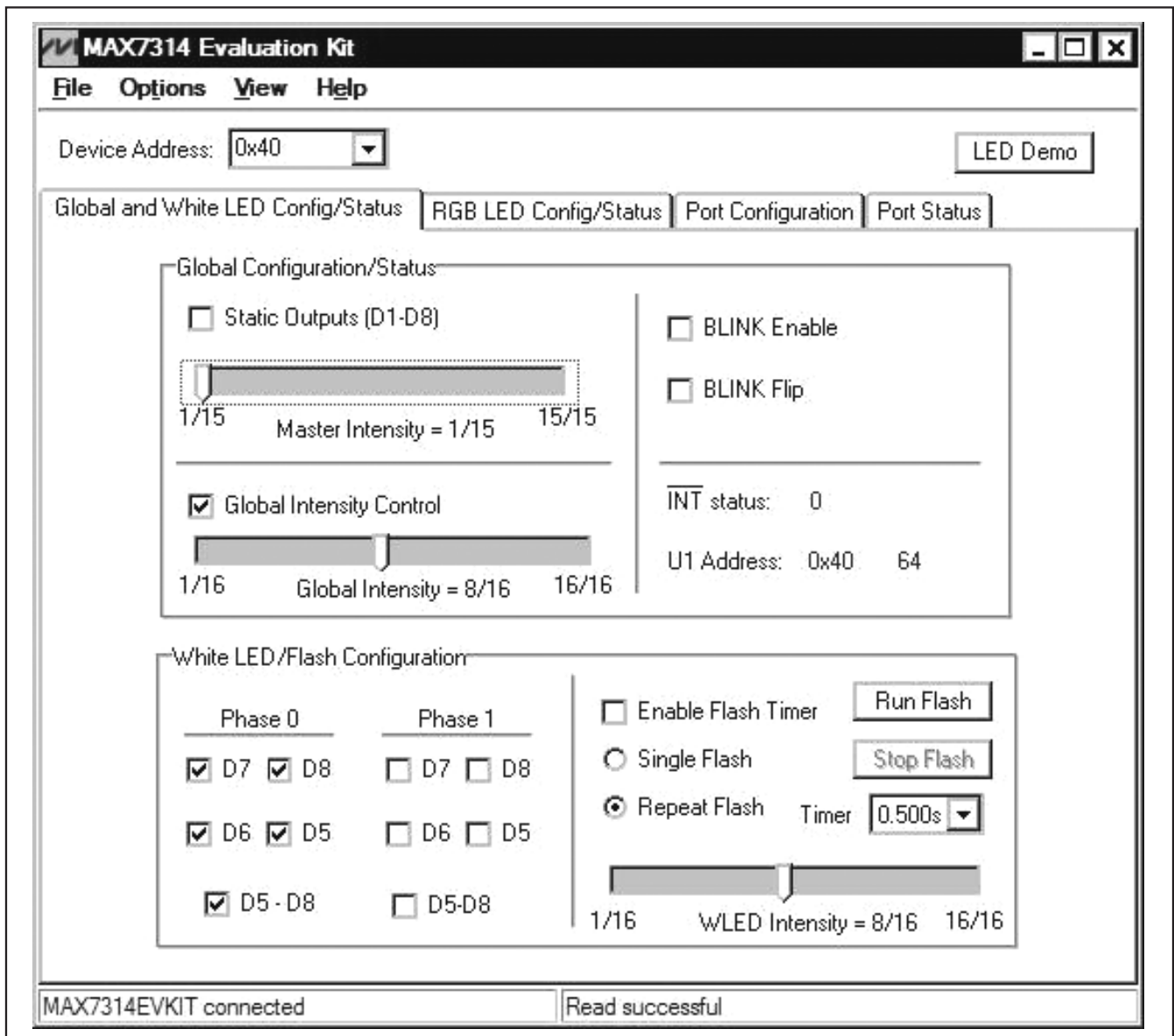

Figure 1. MAX7314 Evaluation Software Main Window (Global and White LED Config/Status Tab)

MAX7314 Evaluation Kit

Evaluates: MAX7314

checkboxes are unchecked and all white LED checkboxes are disabled. To stop the flash sequence, press the **Stop Flash** button, and to disable the flash feature, uncheck the **Enable Flash Timer** checkbox.

Warning: Do not continuously stare at LEDs.

RGB LED Config/Status

The **RGB LED Config/Status** tab sheet (see Figure 2) provides full control of the EV kit's RGB LEDs, D1–D4. Select the respective **D_ Phase 0 Enable** checkbox to

enable or disable the respective RGB LED. Select the Phase 0 **Red, Green, or Blue** checkboxes to enable the respective LED color during Phase 0. When **Enable PWM Outputs** is checked (enabled), the RGB LED's track bar independently controls the respective LED's color intensity. When disabled, the track bars are set to full scale, reflecting the state of the MAX7314 IC intensity register.

Select the Phase 1 **Red, Green, or Blue** checkboxes to enable the respective LED during Phase 1. Phase 1

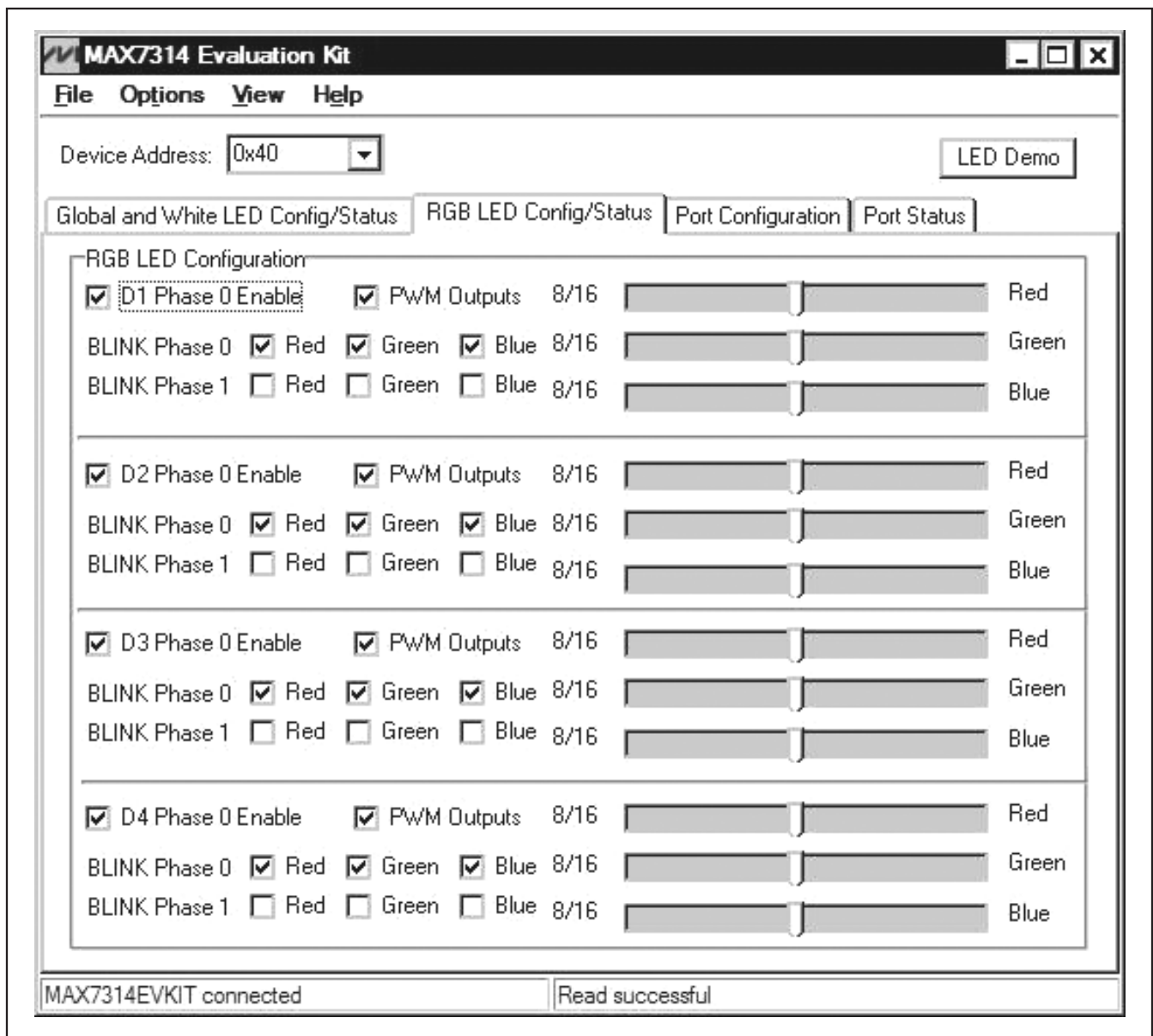

Figure 2. MAX7314 Evaluation Software (RGB LED Config/Status Tab for Configuring the RGB LEDs, D1–D4)

MAX7314 Evaluation Kit

settings are used to demonstrate blink mode operation. The global **BLINK Enable** must be selected on the **Global and White LED Config/Status** tab sheet for the blink function to work.

Port Configuration

As configured, the EV kit allows for the evaluation of the P12–P15 GPIO ports as inputs or outputs by selecting the port's Output or Input radio button. The P0–P11

ports are hardware configured for output-only operation. See the *Software Reset* section for details on the state of the P0–P11 ports after a reset condition.

The **Quick Settings** group box provides two settings that, when selected, automatically configure the P12–P15 ports as all outputs or all inputs. When making individual changes to the P12–P15 ports' configuration, the **Configure** button must be pressed for the setting to

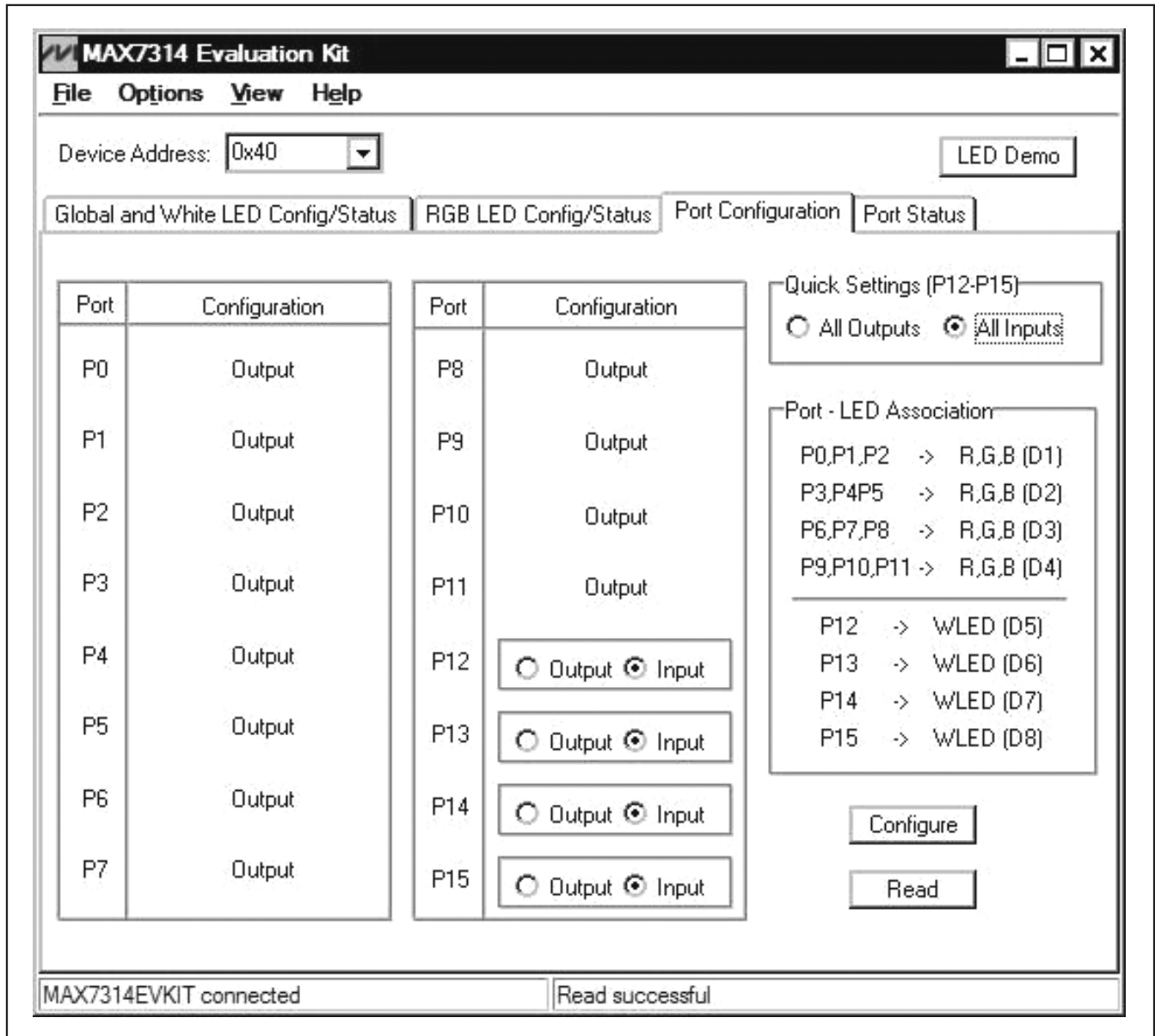

Figure 3. MAX7314 Evaluation Software Main Window (Port Configuration Tab)

MAX7314 Evaluation Kit

Evaluates: MAX7314

take affect. For reference, a group box containing port and LED labels is provided, listing the associations between the P0–P15 ports and the on-board LEDs.

Port Status

The state of the P0–P15 ports can be monitored on the **Port Status** tab sheet. By pressing the **Refresh** button, the State labels are updated to reflect the current status

of each port. When configured as an output, the port's associated label shows Output. When configured as an input, the port's associated label shows a 1 if the port is pulled high or a 0 if the port is pulled low. To have the **Port Status** tab automatically refreshed, check the **Polling Enabled** checkbox.

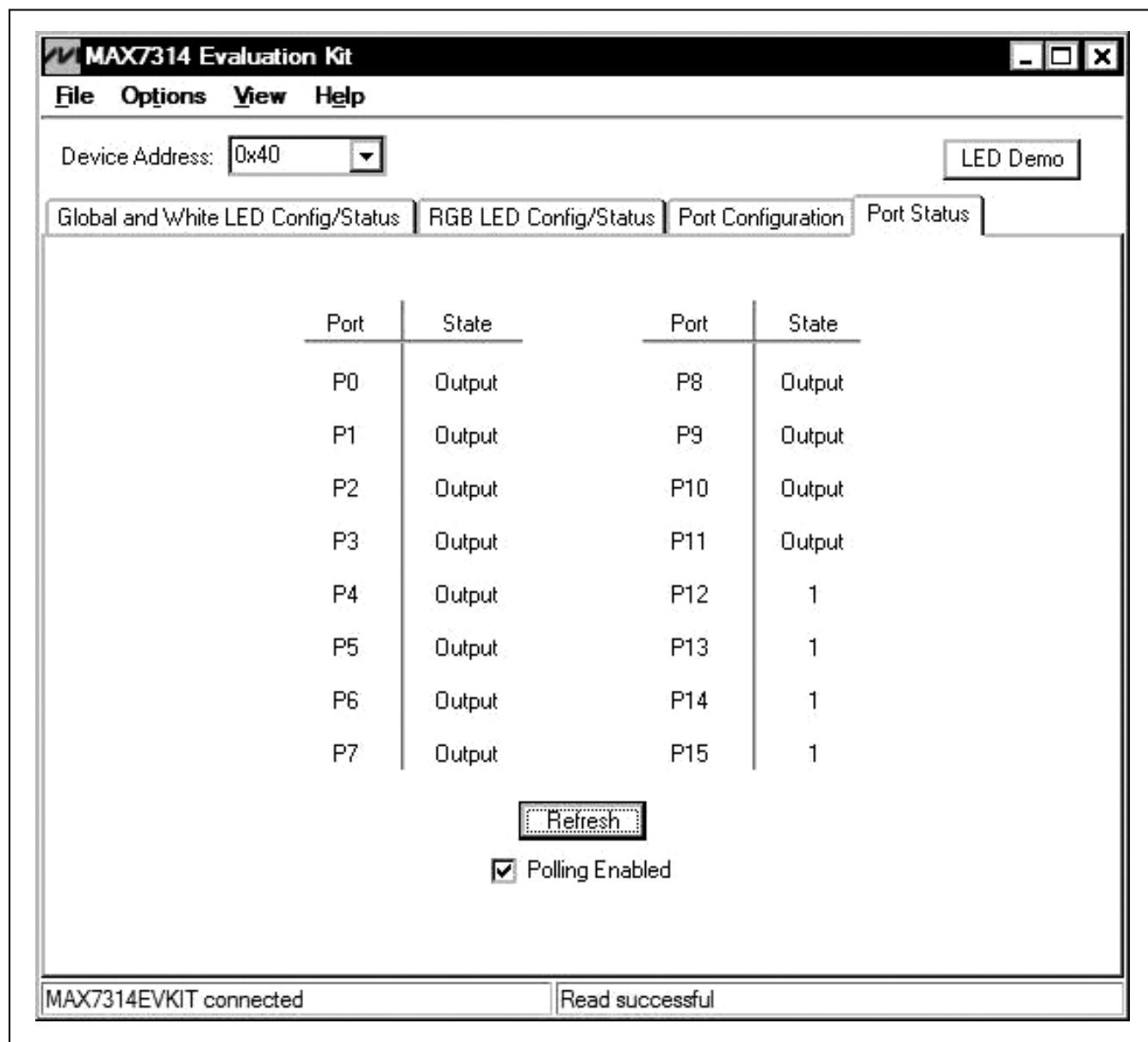

Figure 4. MAX7314 Evaluation Software Main Window (Port Status Tab)

MAX7314 Evaluation Kit

Register View

The contents of the Port Configuration Registers; Output Intensity Registers; Blink Phase Registers; Master, O16; and Configuration Registers can be monitored by opening the **Register View** window (Figure 5), which is accessible by selecting the **View | Register View** menu item. Refer to the MAX7314 IC data sheet for additional register information.

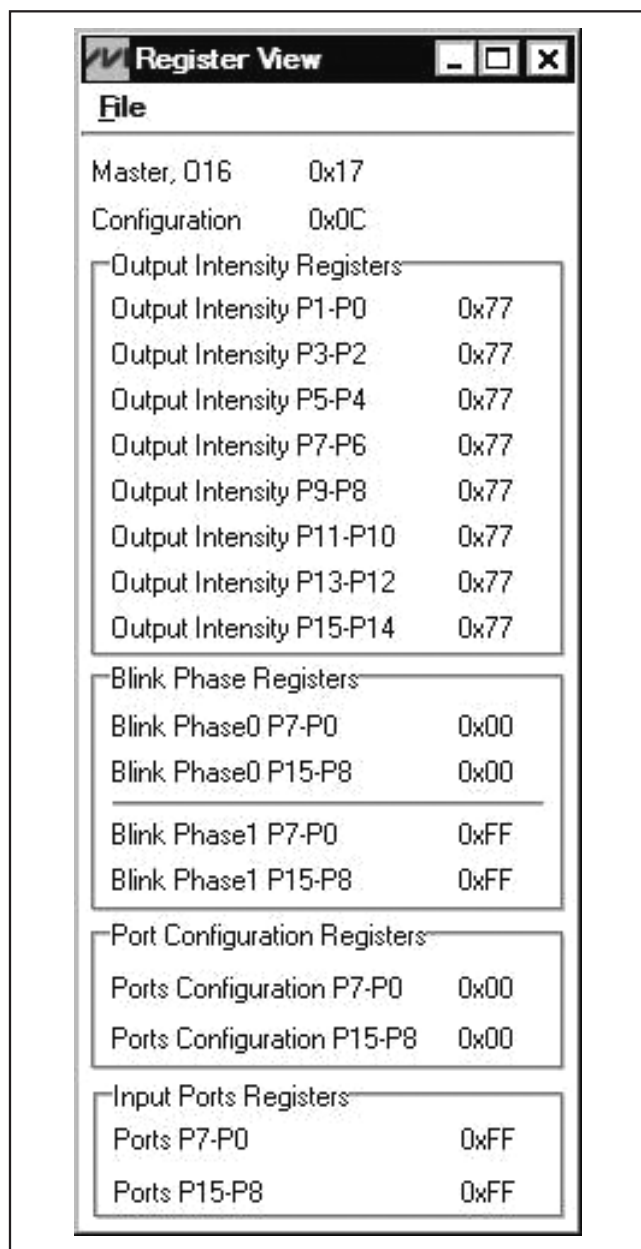

Figure 5. MAX7314 Evaluation Software Register View Window

LED Demo

The **LED Demo** button provided on the software's main window provides a demonstration of the EV kit's operation. Pressing the **LED Demo** button results in the WLEDs and RGBs performing a sequence of blinks, demonstrating the LED control capabilities of the MAX7314 device. Upon completion of the LED demo, the device is initialized (see Table 10).

General-Purpose 2-Wire Interface Utility

The general-purpose **2-wire interface** utility can also be used to communicate with the MAX7314. Use the **View | Interface** menu item to access the utility. The utility configures the 2-wire serial interface parameters, such as start and stop bits, acknowledgments, and clock timing. The 2-wire interface screen allows general-purpose 2-wire commands to be sent using the **SMBusWriteByte** and **SMBusReadByte** options. The interface utility only accepts and outputs hexadecimal number format.

The **Hunt for active listeners** button scans the entire 2-wire address space, reporting each address that is acknowledged. The **SMBusWriteByte** transmits the device address, command, and 1 byte of data. The **SMBusReadByte** transmits the device address, a command, and then retransmits the device address and reads 1 byte of data.

For information on the differences between an I²C and a SMBus™ interface, read Application Note 476: *Comparing the I2C Bus to the SMBus* at www.maxim-ic.com.

General Troubleshooting

Problem: Software reports it cannot find the on-board interface.

- Is the Power Indicator LED (D9) on?
- Is the USB communications cable connected?
- Has Windows plug-and-play detected the board? Bring up Control Panel>System>Device Manager, and look at what device nodes are indicated for USB. If there is an unknown device node attached to the USB, delete it. This process forces plug-and-play to try again.

SMBus is a trademark of Intel Corp.

MAX7314 Evaluation Kit

Evaluates: MAX7314

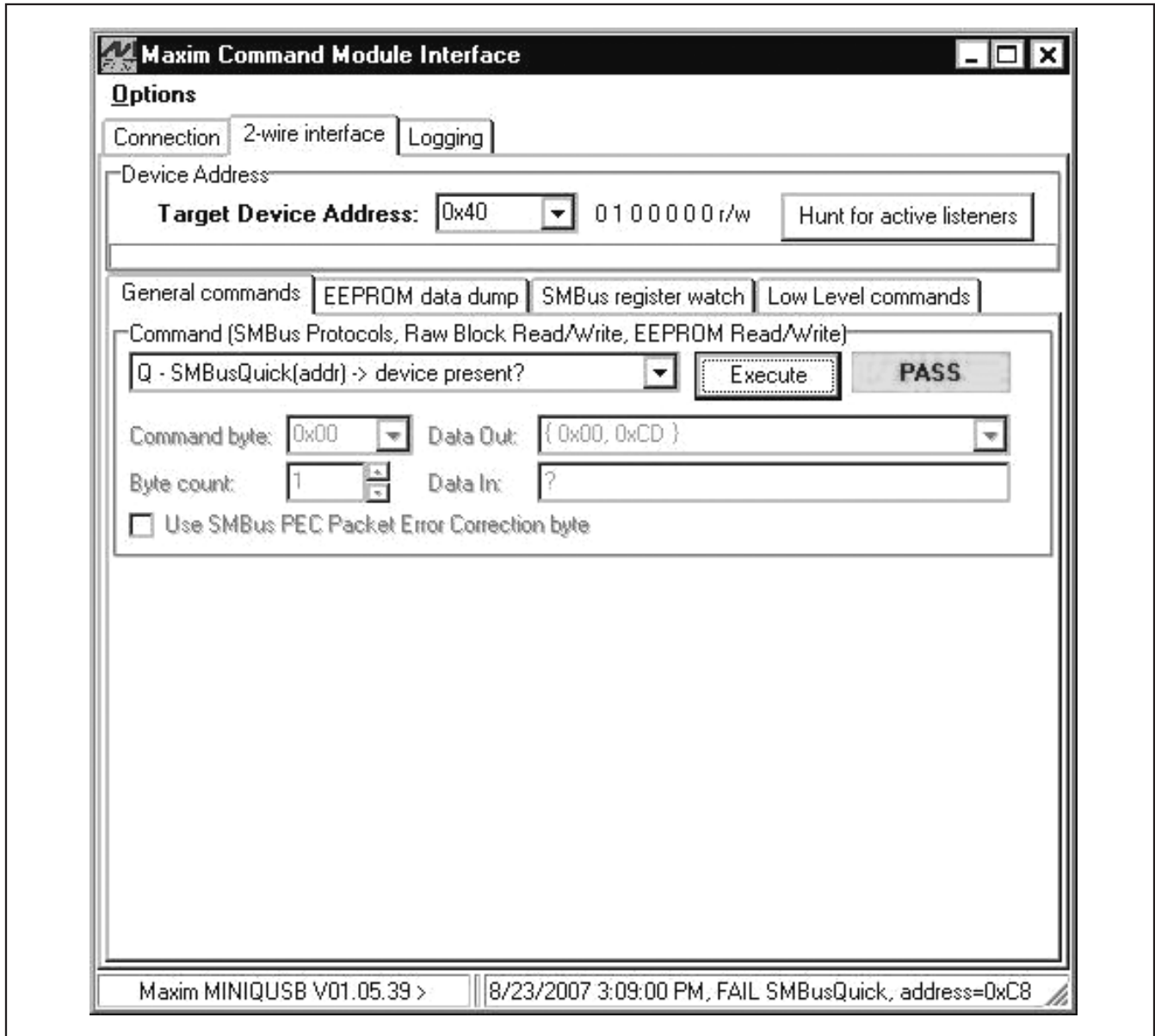

Figure 6. The 2-Wire Interface Window Provides Direct, Low-Level Access to the MAX7314 and 2-Wire Serial Interface

Problem: Unable to find U1.

- Is power applied to the MAX7314 EV kit V+ PC pad or is jumper JU1 configured to pins 2 and 3 to receive power from the USB interface? This is required for powering U1.
- If using the EV kit's on-board interface, are the SCL and SDA signals pulled up to +3.3V? If using a user-supplied interface, are the SCL and SDA signals pulled up to the appropriate voltage level? There must be pullup resistors for the 2-wire SCL and SDA signals.
- If using jumper wires to connect, are the SCL and SDA signals swapped? Is the ground return missing?

MAX7314 Evaluation Kit

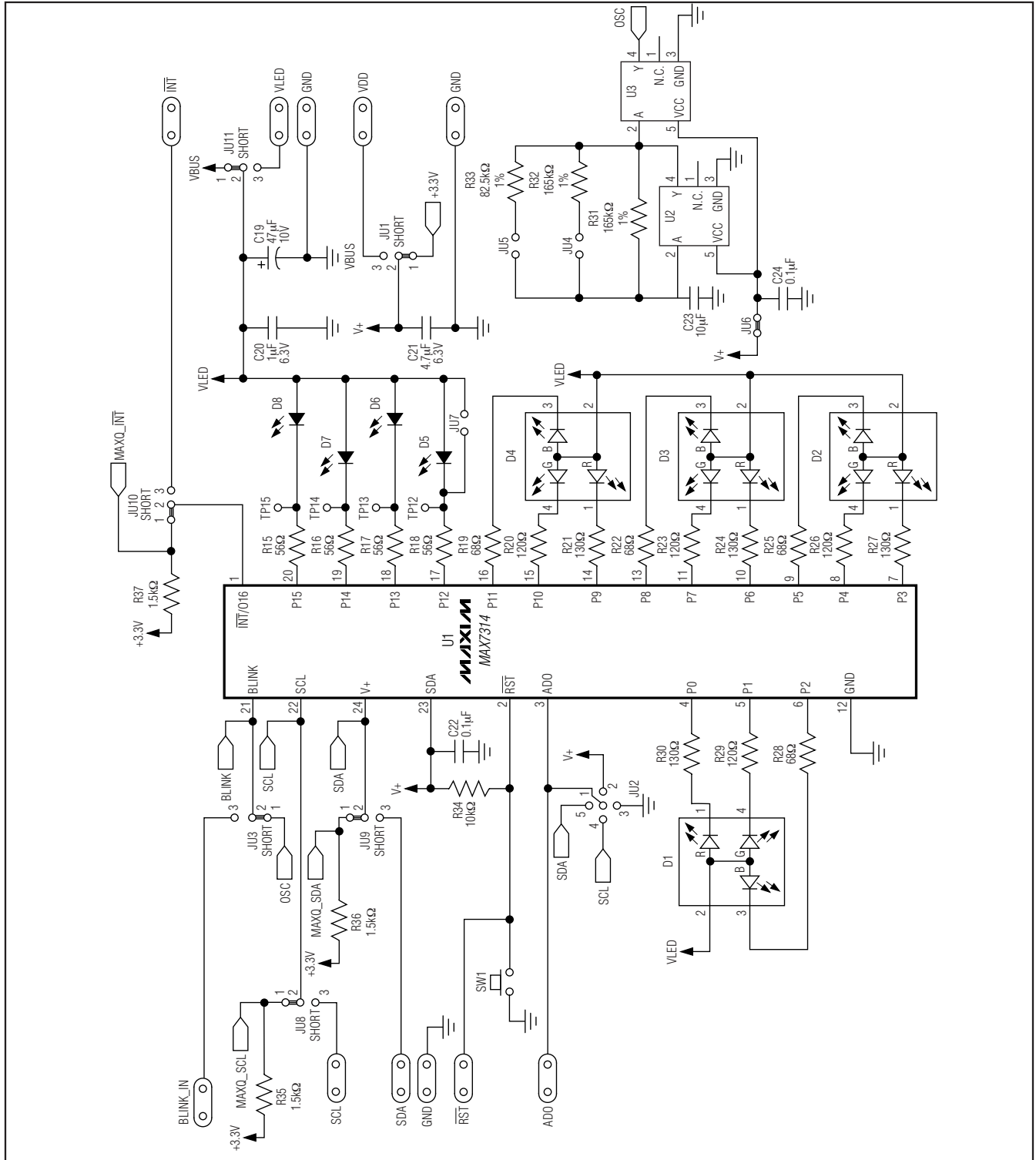

Figure 7a. MAX7314 EV Kit Schematic (Sheet 1 of 2)

MAX7314 Evaluation Kit

Evaluates: MAX7314

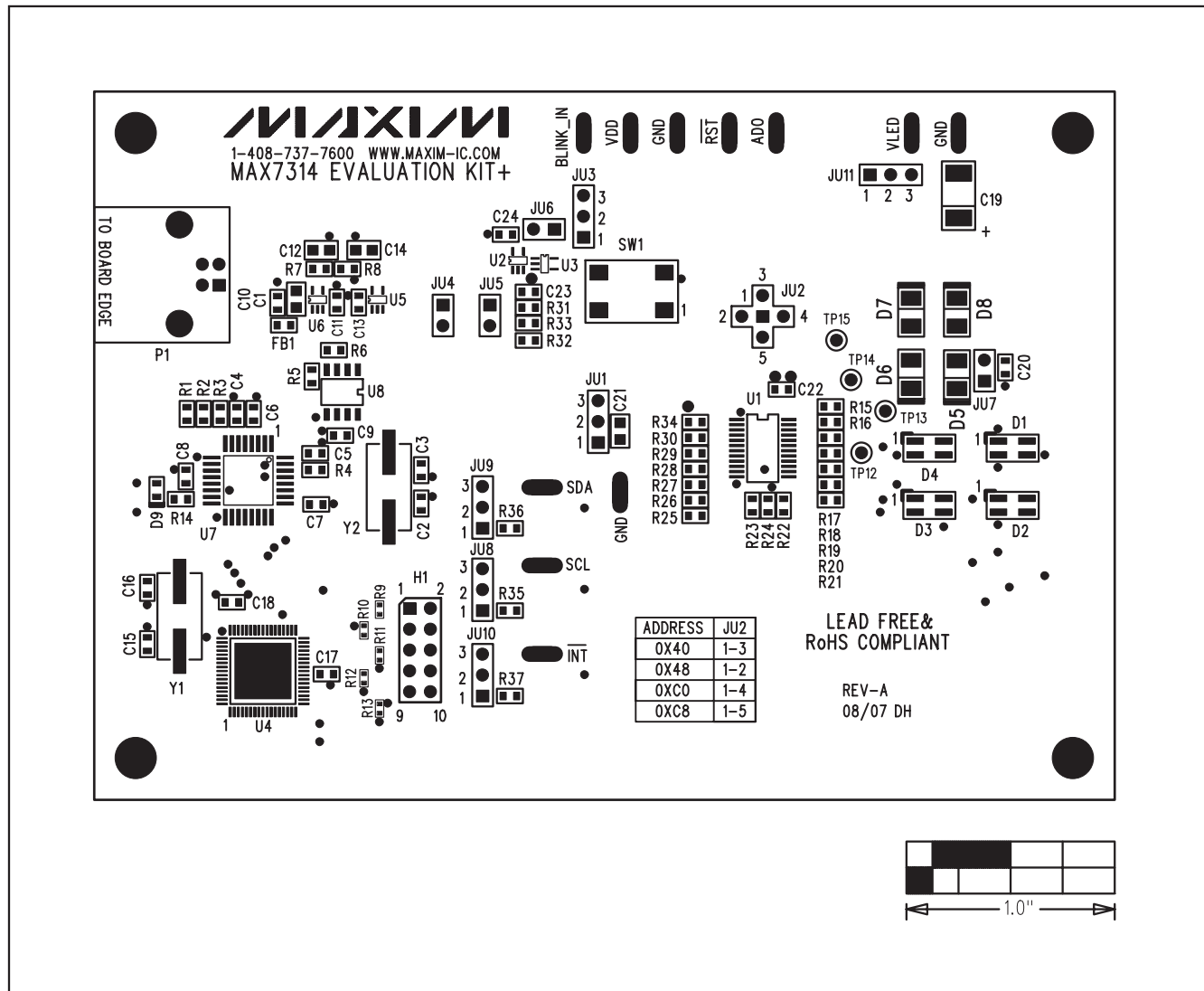

Figure 8. MAX7314 EV Kit Component Placement Guide—Component Side

MAX7314 Evaluation Kit

Evaluates: MAX7314

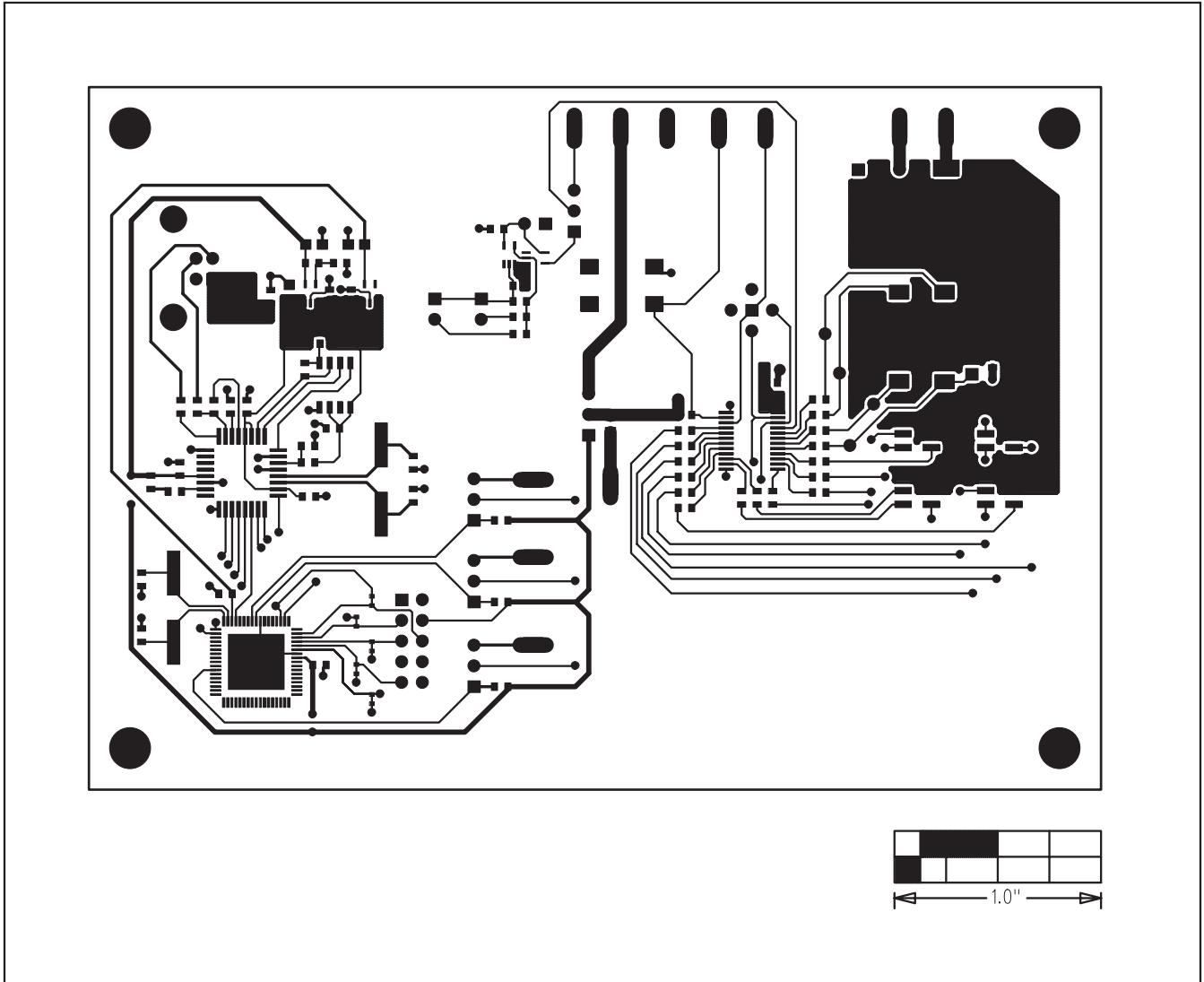

Figure 9. MAX7314 EV Kit PCB Layout—Component Side

MAX7314 Evaluation Kit

Evaluates: MAX7314

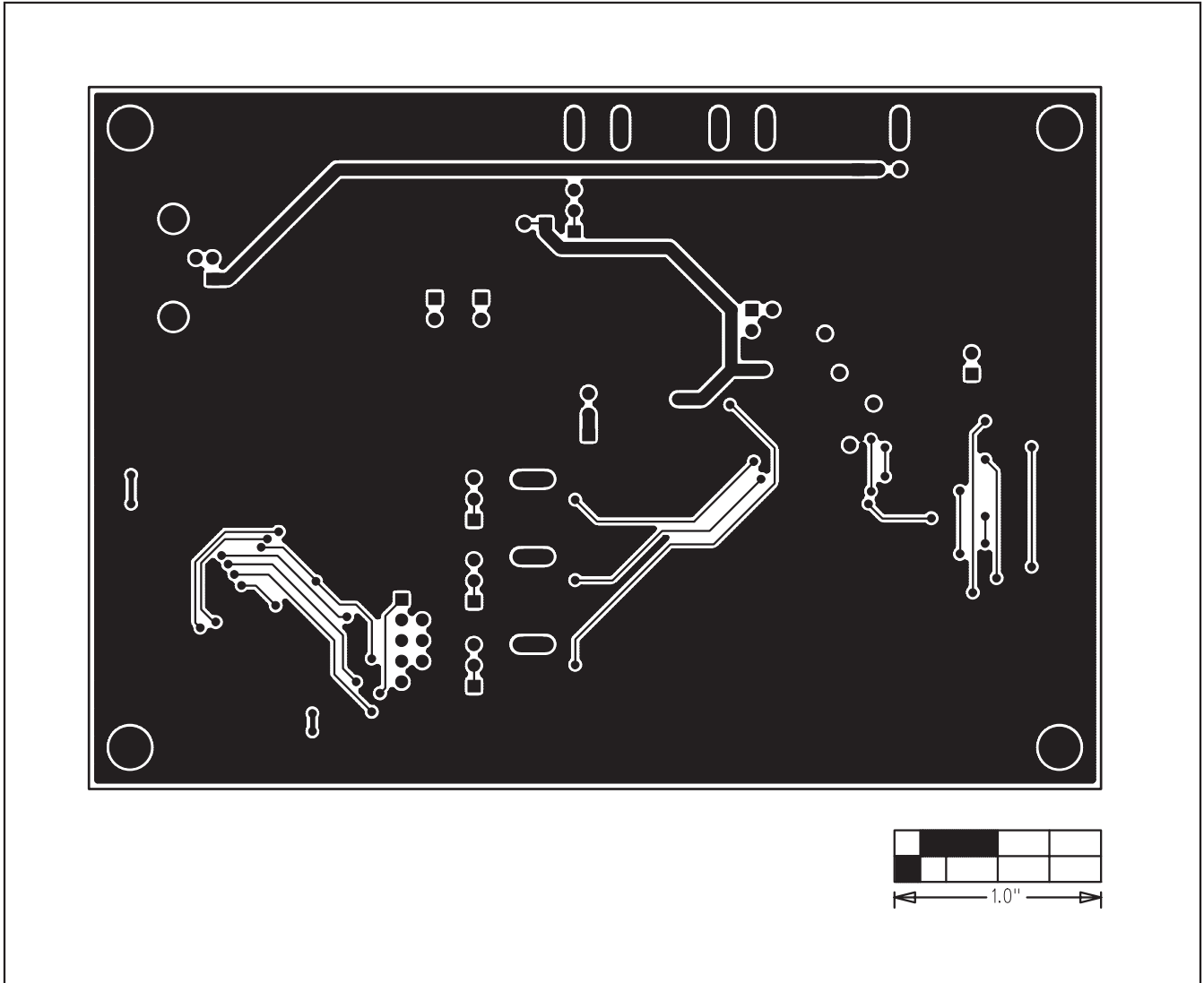

Figure 10. MAX7314 EV Kit PCB Layout—Solder Side