



8th-Order, Lowpass, Butterworth, Switched-Capacitor Filter

MAX7480

General Description

The MAX7480 8th-order, lowpass, Butterworth, switched-capacitor filter (SCF) operates from a single +5V supply. The device draws only 2.9mA of supply current and allows corner frequencies from 1Hz to 2kHz, making it ideal for low-power post-DAC filtering and anti-aliasing applications. The MAX7480 features a shutdown mode, which reduces the supply current to 0.2µA.

Two clocking options are available: self-clocking (through the use of an external capacitor) or external clocking for tighter corner-frequency control. An offset adjust pin allows for adjustment of the DC output level.

The MAX7480 Butterworth filter provides a maximally flat passband response. The fixed response simplifies the design task to selecting a clock frequency.

Features

- ◆ **8th-Order, Lowpass Butterworth Filter**
- ◆ **Low Noise and Distortion: -73dB THD + Noise**
- ◆ **Clock-Tunable Corner Frequency (1Hz to 2kHz)**
- ◆ **100:1 Clock-to-Corner Ratio**
- ◆ **+5V Single-Supply Operation**
- ◆ **Low Power**
 - 2.9mA (Operating Mode)**
 - 0.2µA (Shutdown Mode)**
- ◆ **Available in 8-Pin SO/DIP Package**
- ◆ **Low Output Offset: ±5mV**

Applications

ADC Anti-Aliasing
Post-DAC Filtering

Ordering Information

PART	TEMP. RANGE	PIN-PACKAGE
MAX7480ESA	-40°C to +85°C	8 SO
MAX7480EPA	-40°C to +85°C	8 Plastic DIP

Pin Configuration

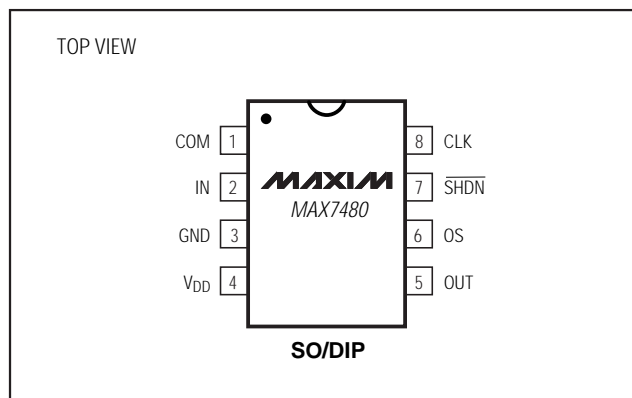

Typical Operating Circuit

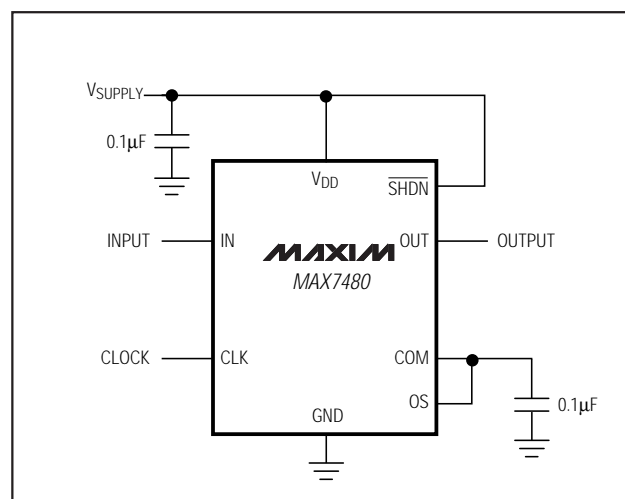

8th-Order, Lowpass, Butterworth, Switched-Capacitor Filter

ABSOLUTE MAXIMUM RATINGS

V _{DD} to GND	-0.3V to +6V
IN, OUT, COM, OS, CLK	-0.3V to (V _{DD} + 0.3V)
SHDN	-0.3V to +6V
OUT Short-Circuit Duration	1sec
Continuous Power Dissipation (T _A = +70°C)	
8-Pin SO (derate 5.88mW/°C above +70°C)	471mW
8-Pin DIP (derate 9.09mW/°C above +70°C)	727mW

Operating Temperature Range	-40°C to +85°C
Storage Temperature Range	-65°C to +150°C
Lead Temperature (soldering, 10sec)	+300°C

Stresses beyond those listed under "Absolute Maximum Ratings" may cause permanent damage to the device. These are stress ratings only, and functional operation of the device at these or any other conditions beyond those indicated in the operational sections of the specifications is not implied. Exposure to absolute maximum rating conditions for extended periods may affect device reliability.

ELECTRICAL CHARACTERISTICS

(V_{DD} = +5V, filter output measured at OUT, 10k Ω || 50pF load to GND at OUT, OS = COM, 0.1 μ F from COM to GND, $\overline{\text{SHDN}}$ = V_{DD}, f_{CLK} = 100kHz, T_A = T_{MIN} to T_{MAX}, unless otherwise noted. Typical values are at T_A = +25°C.)

PARAMETER	SYMBOL	CONDITIONS	MIN	TYP	MAX	UNITS
FILTER CHARACTERISTICS						
Corner Frequency	f _C	(Note 1)	0.001 to 2			kHz
Clock-to-Corner Ratio	f _{CLK} / f _C		100:1			
Clock-to-Corner Tempco			10			ppm/°C
Output Voltage Range			0.25	V _{DD} - 0.25		V
Output Offset Voltage	V _{OFFSET}	V _{IN} = V _{COM} = V _{DD} / 2		±5	±25	mV
DC Insertion Gain with Output Offset Removed		V _{COM} = V _{DD} / 2 (Note 2)	-0.1	0.15	0.3	dB
Total Harmonic Distortion plus Noise	THD+N	f _{IN} = 200Hz, V _{IN} = 4Vp-p, measurement bandwidth = 22kHz	-73			dB
OS Voltage Gain to OUT	A _{OS}		1			V/V
Input Voltage Range at OS	V _{OS}		V _{COM} ±0.1			V
COM Voltage Range	V _{COM}	Input, COM externally driven	V _{DD} / 2 - 0.5	V _{DD} / 2	V _{DD} / 2 + 0.5	V
		Output, COM internally biased	V _{DD} / 2 - 0.2	V _{DD} / 2	V _{DD} / 2 + 0.2	
Input Resistance at COM	R _{COM}		75	125		k Ω
Clock Feedthrough			10			mVp-p
Resistive Output Load Drive	R _L		10	1		k Ω
Maximum Capacitive Load at OUT	C _L		50	500		pF
Input Leakage Current at COM		$\overline{\text{SHDN}}$ = GND, V _{COM} = 0 to V _{DD}		±0.1	±10	μ A
Input Leakage Current at OS		V _{OS} = 0 to (V _{DD} - 1V) (Note 3)		±0.1	±10	μ A
CLOCK						
Internal Oscillator Frequency	f _{OSC}	C _{OSC} = 1000pF (Note 4)	40	53	67	kHz
Clock Input Current	I _{CLK}	V _{CLK} = 0 or 5V		±24	±40	μ A
Clock Input High	V _{IH}		V _{DD} - 0.5			V
Clock Input Low	V _{IL}				0.5	V

8th-Order, Lowpass, Butterworth, Switched-Capacitor Filter

MAX7480

ELECTRICAL CHARACTERISTICS (continued)

($V_{DD} = +5V$, filter output measured at OUT, $10k\Omega \parallel 50pF$ load to GND at OUT, OS = COM, $0.1\mu F$ from COM to GND, $\overline{SHDN} = V_{DD}$, $f_{CLK} = 100kHz$, $T_A = T_{MIN}$ to T_{MAX} , unless otherwise noted. Typical values are at $T_A = +25^\circ C$.)

PARAMETER	SYMBOL	CONDITIONS	MIN	TYP	MAX	UNITS
POWER REQUIREMENTS						
Supply Voltage	V_{DD}		4.5		5.5	V
Supply Current	I_{DD}	Operating mode, no load, IN = OS = COM		2.9	3.5	mA
Shutdown Current	$I_{\overline{SHDN}}$	$\overline{SHDN} = GND$, CLK driven from 0 to V_{DD}		0.2	1	μA
Power-Supply Rejection Ratio	PSRR	Measured at DC		60		dB
SHUTDOWN						
\overline{SHDN} Input High	V_{SDH}		$V_{DD} - 0.5$			V
\overline{SHDN} Input Low	V_{SDL}				0.5	V
\overline{SHDN} Input Leakage Current		$V_{\overline{SHDN}} = 0$ to V_{DD}		± 0.1	± 10	μA

FILTER CHARACTERISTICS

($V_{DD} = +5V$, filter output measured at OUT, $10k\Omega \parallel 50pF$ load to GND at OUT, $\overline{SHDN} = V_{DD}$, $V_{COM} = V_{OS} = V_{DD}/2$, $f_{CLK} = 100kHz$, $T_A = T_{MIN}$ to T_{MAX} , unless otherwise noted. Typical values are at $T_A = +25^\circ C$.)

PARAMETER	CONDITIONS	MIN	TYP	MAX	UNITS
Insertion Gain Relative to DC Gain	$f_{IN} = 0.5f_C$	-0.1	0.0		dB
	$f_{IN} = f_C$	-3.5	-3.0	-2.5	
	$f_{IN} = 2f_C$		-48	-43	
	$f_{IN} = 3f_C$		-76	-70	

Note 1: The maximum f_C is defined as the clock frequency $f_{CLK} = 100 \cdot f_C$ at which the peak SINAD drops to 68dB with a sinusoidal input at $0.2f_C$.

Note 2: DC insertion gain is defined as $\Delta V_{OUT} / \Delta V_{IN}$.

Note 3: OS voltages above $V_{DD} - 1V$ saturate the input and result in a $75\mu A$ typical input leakage current.

Note 4: $f_{OSC} (kHz) \approx 53 \cdot 10^3 / C_{OSC} (pF)$.

8th-Order, Lowpass, Butterworth, Switched-Capacitor Filter

Typical Operating Characteristics

($V_{DD} = +5V$, $f_{CLK} = 100kHz$, $\overline{SHDN} = V_{DD}$, $V_{COM} = V_{OS} = V_{DD} / 2$, $T_A = +25^{\circ}C$, unless otherwise noted.)

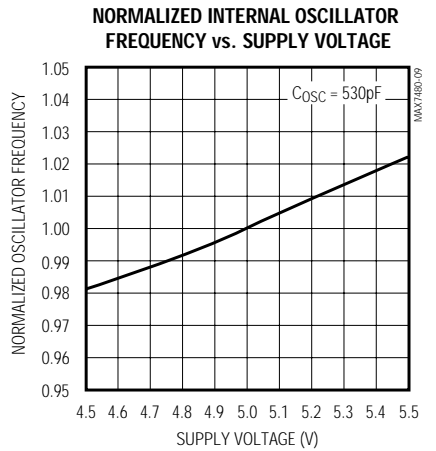
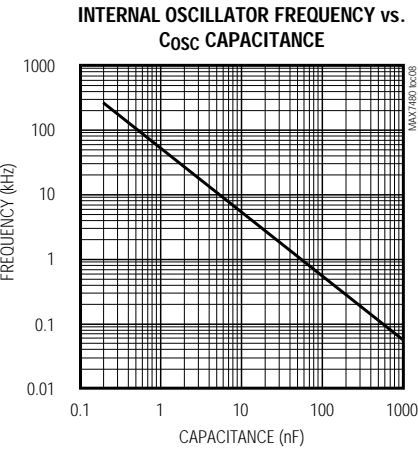
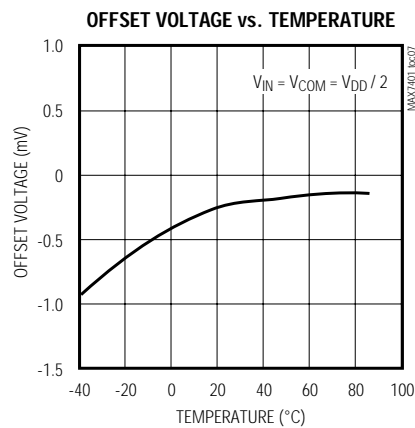
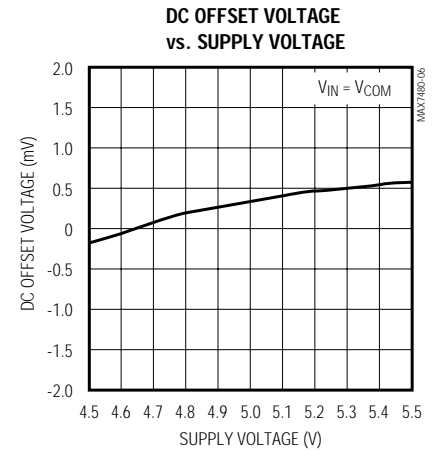
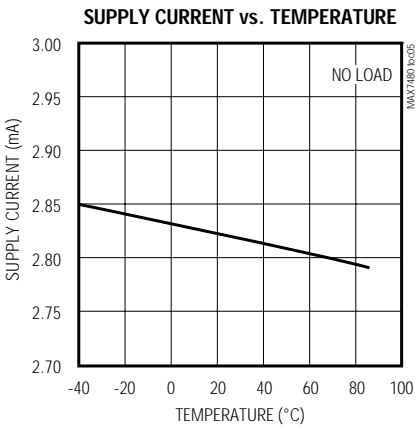
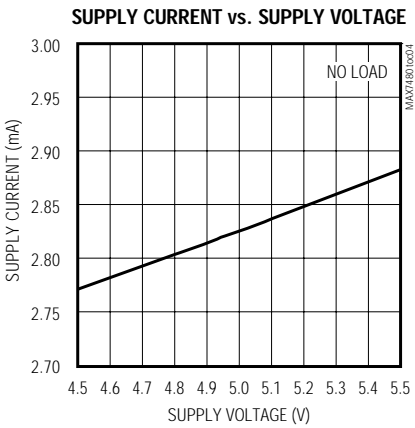
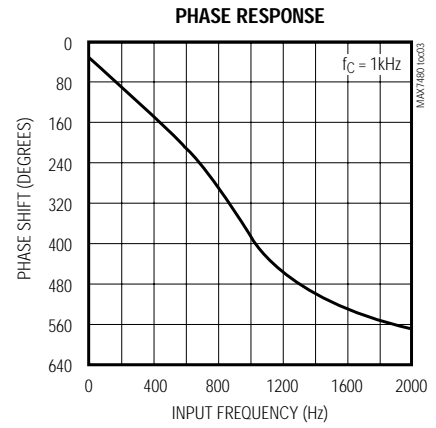
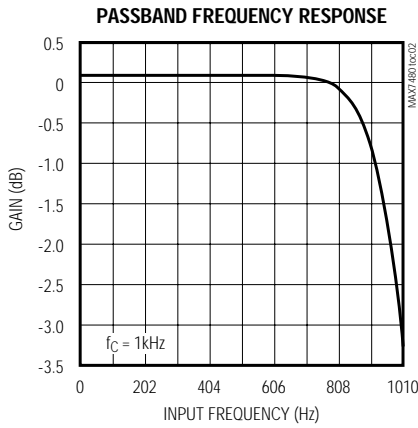
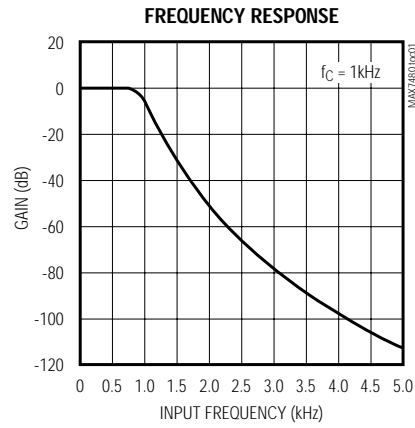

8th-Order, Lowpass, Butterworth, Switched-Capacitor Filter

MAX7480

Typical Operating Characteristics (continued)

($V_{DD} = +5V$, $f_{CLK} = 100kHz$, $\overline{SHDN} = V_{DD}$, $V_{COM} = V_{OS} = V_{DD} / 2$, $T_A = +25^{\circ}C$, unless otherwise noted.)

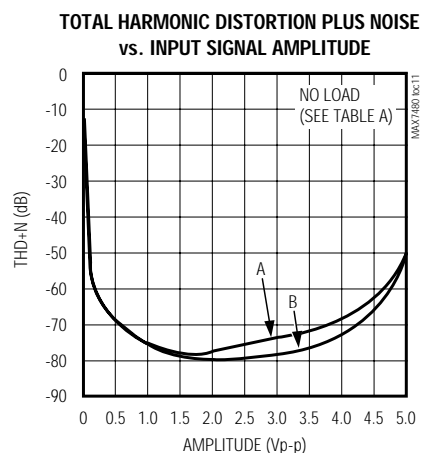
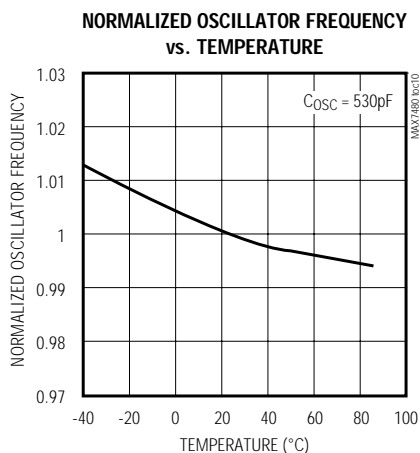

Table A. THD+N vs. Input Signal Amplitude Test Conditions

TRACE	f_{IN} (Hz)	f_C (kHz)	f_{CLK} (kHz)	MEASUREMENT BANDWIDTH (kHz)
A	400	2	200	22
B	200	1	100	22

8th-Order, Lowpass, Butterworth, Switched-Capacitor Filter

Pin Description

PIN	NAME	FUNCTION
1	COM	Common Input Pin. Biased internally at mid-supply. Bypass externally to GND with a 0.1 μ F capacitor. To override internal biasing, drive with an external supply.
2	IN	Filter Input
3	GND	Ground
4	V _{DD}	+5V Supply Input
5	OUT	Filter Output
6	OS	Offset Adjust Input. To adjust output offset, bias OS externally. Connect OS to COM if no offset adjustment is needed. Refer to <i>Offset and Common-Mode Input Adjustment</i> section.
7	$\overline{\text{SHDN}}$	Shutdown Input. Drive low to enable shutdown mode; drive high or connect to V _{DD} for normal operation.
8	CLK	Clock Input. To override the internal oscillator, connect to an external clock; otherwise, connect an external capacitor (C _{OSC}) from CLK to GND to set the internal oscillator frequency.

Detailed Description

The MAX7480 Butterworth filter operates with a 100:1 clock-to-corner frequency ratio and a 2kHz maximum corner frequency.

Lowpass Butterworth filters provide a maximally flat passband response, making them ideal for instrumentation applications that require minimum deviation from the DC gain throughout the passband.

Figure 1 shows the difference between Bessel and Butterworth filter frequency responses. With the filter cutoff frequencies set at 1kHz, trace A shows the Bessel filter response and trace B shows the Butterworth filter response.

Background Information

Most switched-capacitor filters (SCFs) are designed with biquadratic sections. Each section implements two filtering poles, and the sections are cascaded to produce higher-order filters. The advantage to this approach is ease of design. However, this type of design is highly sensitive to component variations if any section's Q is high. An alternative approach is to emulate a passive network using switched-capacitor integrators with summing and scaling. Figure 2 shows a basic 8th-order ladder filter structure.

A switched-capacitor filter such as the MAX7480 emulates a passive ladder filter. The filter's component sensitivity is low when compared to a cascaded biquad design, because each component affects the entire filter shape, not just one pole-zero pair. In other words, a mismatched component in a biquad design will have a concentrated error on its respective poles, while the same mismatch in a ladder filter design results in an error distributed over all poles.

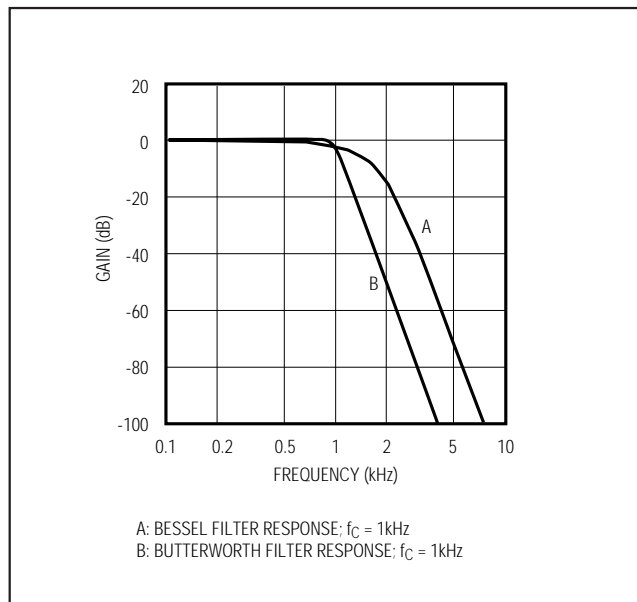

Figure 1. Bessel vs. Butterworth Filter Frequency Response

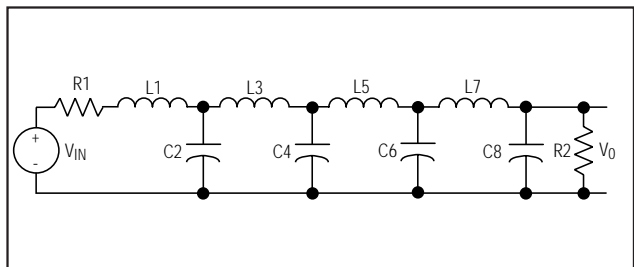

Figure 2. 8th-Order Ladder Filter Network

8th-Order, Lowpass, Butterworth, Switched-Capacitor Filter

Clock Signal

External Clock

The MAX7480 SCF is designed for use with external clocks that have a 40% to 60% duty cycle. When using an external clock with these devices, drive CLK with a CMOS gate powered from 0 to V_{DD}. Varying the rate of the external clock adjusts the corner frequency of the filter as follows:

$$f_C = f_{CLK} / 100$$

Internal Clock

When using the internal oscillator, connect a capacitor (C_{OSC}) between CLK and ground. The value of the capacitor determines the oscillator frequency as follows:

$$f_{OSC}(\text{kHz}) = \frac{53 \cdot 10^3}{C_{OSC}}; C_{OSC} \text{ in pF}$$

Minimize the stray capacitance at CLK so that it does not affect the internal oscillator frequency. Vary the rate of the internal oscillator to adjust the filter's corner frequency by a 100:1 clock to corner-frequency ratio. For example, an internal oscillator frequency of 100kHz produces a nominal corner frequency of 1kHz.

Input Impedance vs. Clock Frequencies

The MAX7480's input impedance is effectively that of a switched-capacitor resistor, and is inversely proportional to frequency. The input impedance values determined below represent the average input impedance, since the input current is not continuous. As a rule, use a driver with an output impedance less than 10% of the filter's input impedance. Estimate the input impedance of the filter using the following formula:

$$Z_{IN} = \frac{1}{(f_{CLK} \cdot C_{IN})}$$

where f_{CLK} = clock frequency and C_{IN} = 2.31pF.

Low-Power Shutdown Mode

This device features a shutdown mode that is activated by driving SHDN low. In shutdown mode, the filter's supply current reduces to 0.2μA (typ) and its output becomes high impedance. For normal operation, drive SHDN high or connect to V_{DD}.

Applications Information

Offset and Common-Mode Input Adjustment

The voltage at COM sets the common-mode input voltage and is biased at mid-supply with an internal resistor-divider. Bypass COM with a 0.1μF capacitor and

connect OS to COM. For applications requiring offset adjustment or DC level shifting, apply an external bias voltage through a resistor-divider network to OS, as shown in Figure 3. (Note: Do not leave OS unconnected.) The output voltage is represented by this equation:

$$V_{OUT} = (V_{IN} - V_{COM}) + V_{OS}$$

with V_{COM} = V_{DD} / 2 (typical), where (V_{IN} - V_{COM}) is lowpass-filtered by the SCF and V_{OS} is added at the output stage. See the *Electrical Characteristics* for the voltage range of COM and OS. Changing the voltage on COM or OS significantly from mid-supply reduces the filter's dynamic range.

Power Supplies

The MAX7480 operates from a single +5V supply. Bypass V_{DD} to GND with a 0.1μF capacitor. If dual supplies (±2.5V) are required, connect COM to system ground and connect GND to the negative supply. Figure 4 shows an example of dual-supply operation. Single- and dual-supply performances are equivalent. For either single- or dual-supply operation, drive CLK and SHDN from GND (V₋ in dual-supply operation) to V_{DD}. For ±5V dual-supply applications, use the MAX291–MAX297.

Input Signal Amplitude Range

The optimal input signal range is determined by observing the voltage level at which the total harmonic distortion plus noise (THD+N) is minimized for a given corner frequency. The *Typical Operating Characteristics* shows a graph of the device's THD+N response as the input signal's peak-to-peak amplitude is varied. This measurement is made with OS and COM biased at mid-supply.

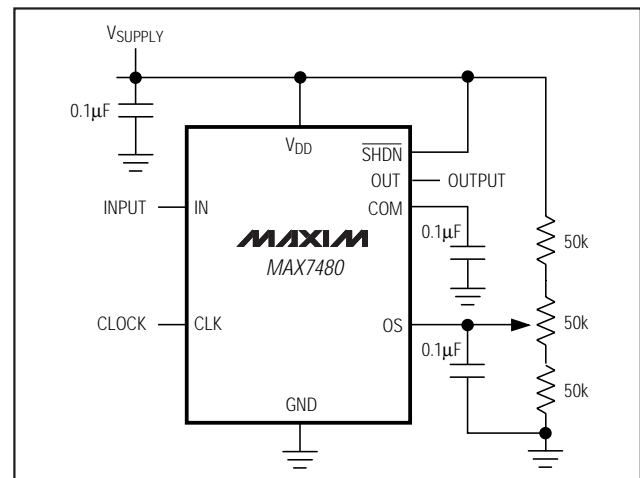

Figure 3. Offset Adjustment Circuit