



# 200mA Step-Up Converters in 6-Pin SOT23 and TDFN

MAX8569A/MAX8569B

## General Description

The MAX8569A/MAX8569B low-quiescent-current boost regulators provide up to 200mA at output voltages up to 5.5V from a 1.5V to 5.5V input source. The built-in synchronous rectifier allows for over 90% efficiency while achieving small size and low cost by eliminating the need for an external Schottky diode.

The MAX8569A provides an adjustable output while the MAX8569B is fixed at 3.0V or 3.3V. The MAX8569B features a power-on reset output (RST) to signal that the output has reached regulation. All devices connect the battery input to the output during shutdown, allowing the input battery to be used as a backup or real-time clock supply when the converter is off.

## Applications

- |                              |                         |
|------------------------------|-------------------------|
| Medical Diagnostic Equipment | Cordless Phones         |
| Digital Cameras              | Battery Backup          |
| PDAs and Smartphones         | PC Cards                |
|                              | Local 3.3V or 5V Supply |

## Typical Operating Circuit

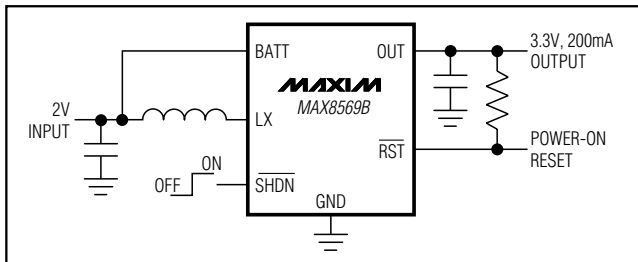

Selector Guide appears at end of data sheet.

## Features

- ◆ Over 200mA Available Output Current
- ◆ 1.5V to 5.5V Input Voltage Range
- ◆ BATT Connected to OUT in Shutdown for Backup Power
- ◆ Up to 95% Efficiency
- ◆ 7µA Typical Quiescent Current
- ◆ <1µA Shutdown Supply Current
- ◆ Internal Synchronous Rectifier
- ◆ 750mA Switch Current Limit
- ◆ RST Output (MAX8569B)
- ◆ Adjustable Output Voltage (MAX8569A)
- ◆ Fixed 3.0V or 3.3V Output Voltage (MAX8569B)

## Ordering Information

PART	TEMP RANGE	PIN-PACKAGE
MAX8569AEUT-T*	-40°C to +85°C	6 SOT23-6 (U6FH-6)
MAX8569AETT+	-40°C to +85°C	6 TDFN 3mm x 3mm (T633-1)
MAX8569BEUT-T*	-40°C to +85°C	6 SOT23-6 (U6FH-6)
MAX8569BETT+	-40°C to +85°C	6 TDFN 3mm x 3mm (T633-1)
MAX8569BETT30+	-40°C to +85°C	6 TDFN 3mm x 3mm (T633-1)

\*Future product—contact factory for availability.

+Denotes lead-free packaging.

## Pin Configurations

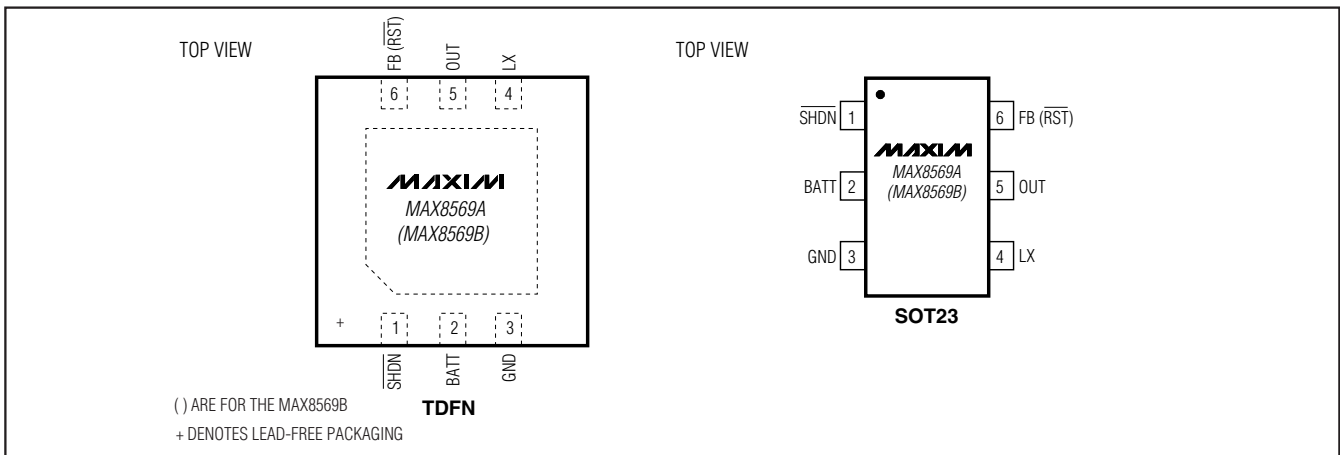

For pricing, delivery, and ordering information, please contact Maxim/Dallas Direct! at 1-888-629-4642, or visit Maxim's website at [www.maxim-ic.com](http://www.maxim-ic.com).

# 200mA Step-Up Converters in 6-Pin SOT23 and TDFN

## ABSOLUTE MAXIMUM RATINGS

BATT, LX, OUT, FB, $\overline{\text{RST}}$ to GND .....	-0.3V to +6V
$\overline{\text{SHDN}}$ to GND .....	-0.3V to ( $V_{\text{OUT}} + 0.3\text{V}$ )
LX Current .....	1.5A Peak
Continuous Power Dissipation ( $T_A = +70^\circ\text{C}$ )	
6-Pin SOT23 (derate 9.1mW/ $^\circ\text{C}$ above $+70^\circ\text{C}$ ) .....	727mW
6-Pin TDFN 3mm x 3mm	
(derate 18.2mW/ $^\circ\text{C}$ above $+70^\circ\text{C}$ ) .....	1454mW

Operating Temperature Range .....	-40 $^\circ\text{C}$ to +85 $^\circ\text{C}$
Junction Temperature .....	+150 $^\circ\text{C}$
Storage Temperature Range .....	-65 $^\circ\text{C}$ to +150 $^\circ\text{C}$
Lead Temperature (soldering, 10s) .....	+300 $^\circ\text{C}$

Stresses beyond those listed under "Absolute Maximum Ratings" may cause permanent damage to the device. These are stress ratings only, and functional operation of the device at these or any other conditions beyond those indicated in the operational sections of the specifications is not implied. Exposure to absolute maximum rating conditions for extended periods may affect device reliability.

## ELECTRICAL CHARACTERISTICS

( $\overline{\text{VSHDN}} = V_{\text{OUT}} = 3.3\text{V}$ ,  $V_{\text{BATT}} = 2.0\text{V}$ ,  $T_A = -40^\circ\text{C}$  to  $+85^\circ\text{C}$ . Typical values are at  $T_A = +25^\circ\text{C}$ , unless otherwise noted.) (Note 1)

PARAMETER	CONDITIONS	MIN	TYP	MAX	UNITS	
Battery Input Range		1.5		5.5	V	
Startup Voltage	$R_{\text{LOAD}} = 2.6\text{k}\Omega$	$T_A = +25^\circ\text{C}$	1.22	1.5	V	
		$T_A = -40^\circ\text{C}$ to $+85^\circ\text{C}$	1.24			
Output Voltage	MAX8569A		2.0	5.5	V	
	MAX8569BETT30	$T_A = +25^\circ\text{C}$	2.94	3.0		3.06
		$T_A = -40^\circ\text{C}$ to $+85^\circ\text{C}$	2.925			3.075
	MAX8569B	$T_A = +25^\circ\text{C}$	3.233	3.300		3.366
$T_A = -40^\circ\text{C}$ to $+85^\circ\text{C}$		3.217		3.373		
Feedback Threshold	MAX8569A	$T_A = +25^\circ\text{C}$	1.208	1.228	1.248	V
		$T_A = -40^\circ\text{C}$ to $+85^\circ\text{C}$	1.203		1.253	
Feedback Bias Current	MAX8569A, $V_{\text{FB}} = 1.27\text{V}$	$T_A = +25^\circ\text{C}$		3.5	20	nA
		$T_A = -40^\circ\text{C}$ to $+85^\circ\text{C}$		4		
n-Channel On-Resistance	$I_{\text{LX}} = 100\text{mA}$		0.3	0.7	$\Omega$	
p-Channel On-Resistance	$I_{\text{LX}} = 100\text{mA}$		0.3	0.9	$\Omega$	
n-Channel Switch Current Limit	$T_A = +25^\circ\text{C}$	650	750	920	mA	
	$T_A = -40^\circ\text{C}$ to $+85^\circ\text{C}$	600		975		
Switch Maximum On-Time	$V_{\text{OUT}} = 2.8\text{V}$	3.5	5	6.5	$\mu\text{s}$	
Synchronous Rectifier Zero-Crossing Current	$T_A = +25^\circ\text{C}$	3	25	50	mA	
	$T_A = -40^\circ\text{C}$ to $+85^\circ\text{C}$	0		60		
OUT Quiescent Current	$V_{\text{OUT}} = 3.5\text{V}$ , $V_{\text{FB}} = 1.3\text{V}$ (Note 2)		4	10	$\mu\text{A}$	
OUT Shutdown Current	$V_{\text{OUT}} = 3.5\text{V}$ , $\overline{\text{VSHDN}} = V_{\text{FB}} = 0\text{V}$		0.05	1	$\mu\text{A}$	
BATT Quiescent Current	$V_{\text{OUT}} = 3.5\text{V}$ , $V_{\text{FB}} = 1.3\text{V}$ (Note 3)		3	10	$\mu\text{A}$	
BATT Shutdown Current	$V_{\text{OUT}} = 3.5\text{V}$ , $\overline{\text{VSHDN}} = 0\text{V}$		0.01	1	$\mu\text{A}$	
$\overline{\text{SHDN}}$ Logic-Low				0.3	V	

# 200mA Step-Up Converters in 6-Pin SOT23 and TDFN

MAX8569A/MAX8569B

## ELECTRICAL CHARACTERISTICS (continued)

( $V_{SHDN} = V_{OUT} = 3.3V$ ,  $V_{BATT} = 2.0V$ ,  $T_A = -40^{\circ}C$  to  $+85^{\circ}C$ . Typical values are at  $T_A = +25^{\circ}C$ , unless otherwise noted.) (Note 1)

PARAMETER	CONDITIONS		MIN	TYP	MAX	UNITS
$\overline{SHDN}$ Threshold	Rising edge, 100mV hysteresis (typ), $V_{OUT} = 2.8V$	$T_A = +25^{\circ}C$	1.185	1.228	1.271	V
		$T_A = -40^{\circ}C$ to $+85^{\circ}C$	1.170		1.286	
$\overline{SHDN}$ Input Bias Current	$V_{OUT} = 5.5V$	$T_A = +25^{\circ}C$		13	100	nA
		$T_A = -40^{\circ}C$ to $+85^{\circ}C$		13		
$\overline{RST}$ Low Voltage	$I_{RST} = 1mA$ , $V_{OUT} = 2.5V$				0.2	V
$\overline{RST}$ Leakage Current	$V_{RST} = 5.5V$	$T_A = +25^{\circ}C$		0.1	100	nA
		$T_A = -40^{\circ}C$ to $+85^{\circ}C$		1		
$\overline{RST}$ Threshold	Relative to OUT, 3.3V for MAX8569B, 3.0V for MAX8569BETT30	$T_A = +25^{\circ}C$	85	90	95	%
		$T_A = -40^{\circ}C$ to $+85^{\circ}C$	85	90	97	
LX Leakage Current	$V_{OUT} = 5.5V$	$T_A = +25^{\circ}C$		1	150	nA
		$T_A = -40^{\circ}C$ to $+85^{\circ}C$		150		
Maximum Load Current	$V_{BATT} = 2V$ , $V_{OUT} = 3.3V$			200		mA
Efficiency	$V_{BATT} = 2V$ , $V_{OUT} = 3.3V$ , Figures 1 or 2, $I_{LOAD} = 40mA$			88		%

**Note 1:** Specifications to  $-40^{\circ}C$  are guaranteed by design and not production tested.

**Note 2:** Supply current into OUT. This current is drawn from the source battery, but is reduced in value according to the step-up ratio and efficiency.

**Note 3:** Does not include switching losses and output quiescent current. See the Input Current and Output Voltage vs. Input Voltage (On, 330 $\Omega$ ) graph in the *Typical Operating Characteristics* for operating quiescent current.

# 200mA Step-Up Converters in 6-Pin SOT23 and TDFN

## Typical Operating Characteristics

(Circuit of Figure 2,  $V_{OUT} = 3.3V$ ,  $V_{BATT} = +2V$ ,  $T_A = +25^\circ C$ , circuit of Figure 1,  $T_A = +25^\circ C$ , unless otherwise noted.)

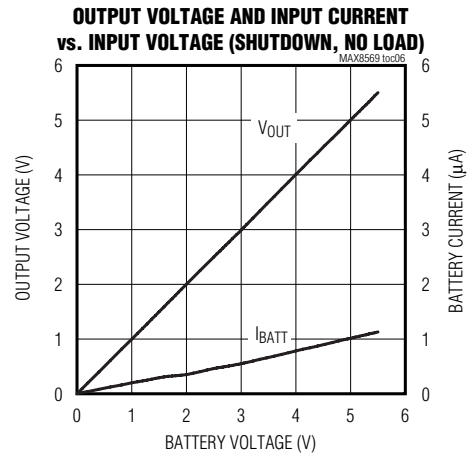
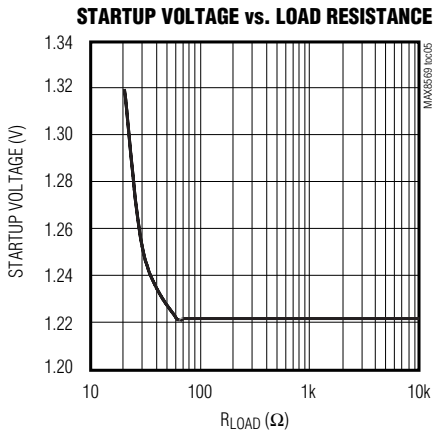
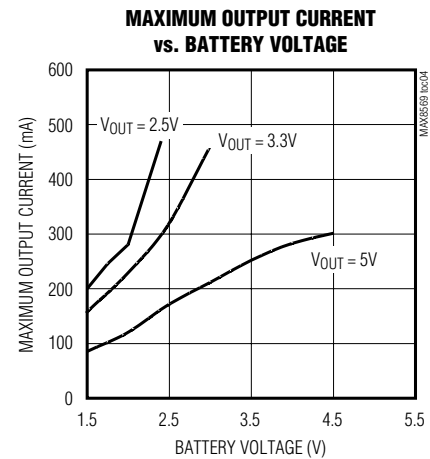
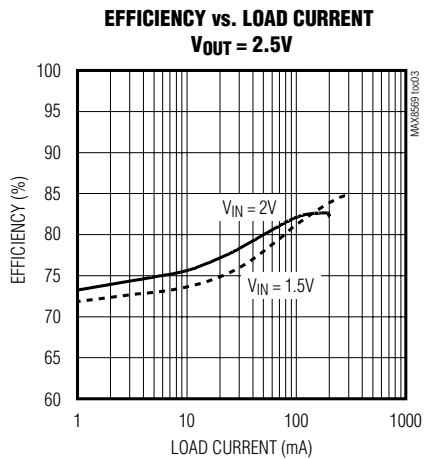
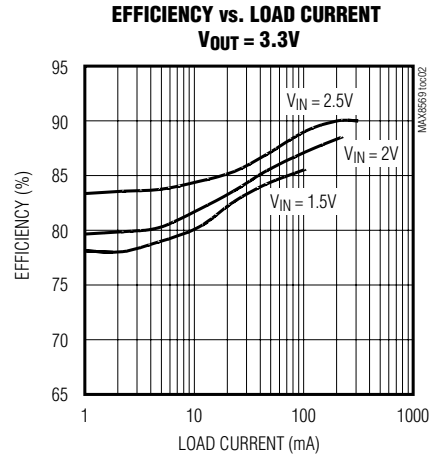
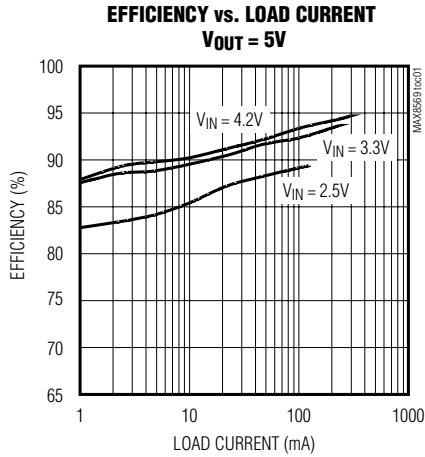

# 200mA Step-Up Converters in 6-Pin SOT23 and TDFN

## Typical Operating Characteristics (continued)

(Circuit of Figure 2,  $V_{OUT} = 3.3V$ ,  $V_{BATT} = +2V$ ,  $T_A = +25^\circ C$ , circuit of Figure 1,  $T_A = +25^\circ C$ , unless otherwise noted.)

**OUTPUT VOLTAGE AND INPUT CURRENT vs. INPUT VOLTAGE (SHUTDOWN, 200mA LOAD)**

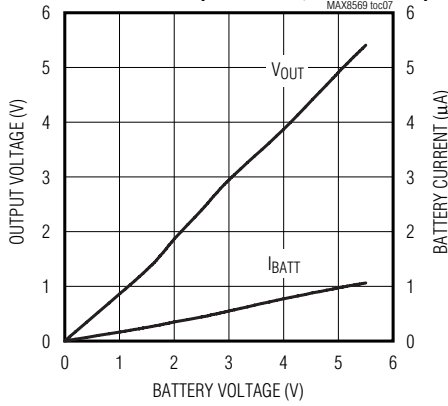

**OUTPUT VOLTAGE AND INPUT CURRENT vs. INPUT VOLTAGE (ON, 330Ω)**

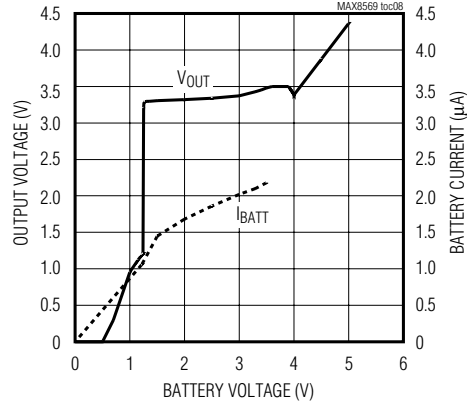

**OUTPUT VOLTAGE AND INPUT CURRENT vs. INPUT VOLTAGE (ON, 16Ω LOAD)**

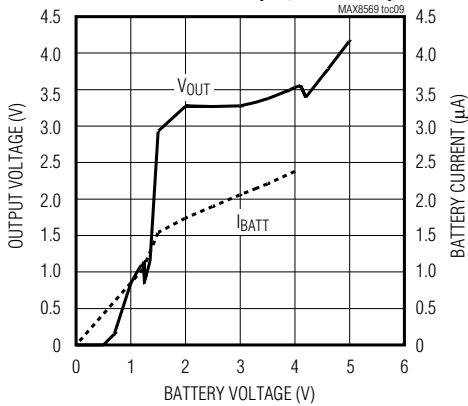

**ON/OFF RESPONSE (R<sub>LOAD</sub> = 33Ω)**

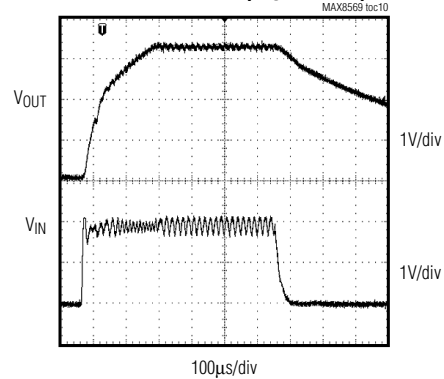

**LOAD TRANSIENT**

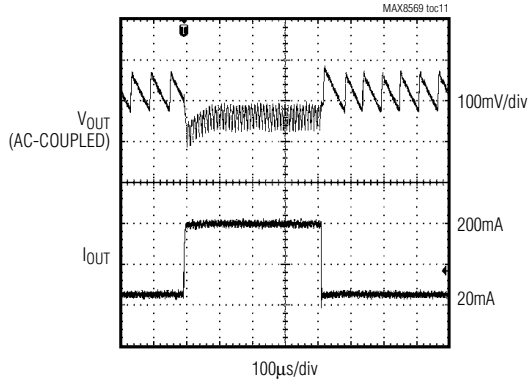

**LINE TRANSIENT**

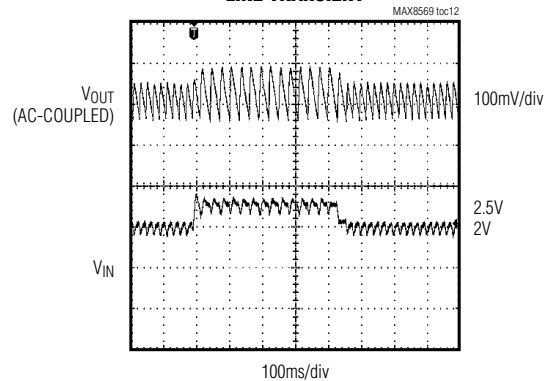

# 200mA Step-Up Converters in 6-Pin SOT23 and TDFN

## Typical Operating Characteristics (continued)

(Circuit of Figure 2,  $V_{OUT} = 3.3V$ ,  $V_{BATT} = +2V$ ,  $T_A = +25^\circ C$ , circuit of Figure 1,  $T_A = +25^\circ C$ , unless otherwise noted.)

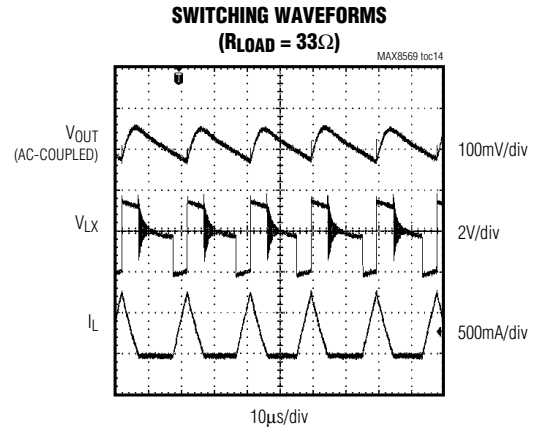
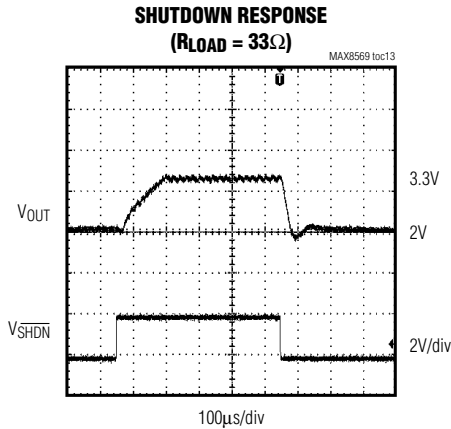

## Pin Description

PIN		NAME	FUNCTION
MAX8569A	MAX8569B		
1	1	$\overline{SHDN}$	Shutdown Input. Drive $\overline{SHDN}$ low to place the MAX8569 in shutdown mode. $\overline{SHDN}$ can be used for a low-battery cutoff (1.228V threshold). See the <i>Low-Battery Cutoff</i> section for details. Drive $\overline{SHDN}$ high for normal operation.
2	2	BATT	Battery Voltage Connection. Connect BATT to a 1.5V to 5.5V supply. Bypass BATT to GND with a 10μF or larger ceramic capacitor.
3	3	GND	Ground
4	4	LX	Inductor Connection. Connect the switched side of the inductor to LX. During shutdown, LX is connected to OUT.
5	5	OUT	Output Voltage. Bypass OUT to GND with a 10μF or larger ceramic capacitor. During shutdown, OUT is connected to LX. OUT is also the bootstrapped supply input for the IC.
6	—	FB	Feedback Input. Connect FB to the center tap of an external resistor-divider from OUT to GND to set the output voltage. $V_{FB}$ regulates to 1.228V.
—	6	$\overline{RST}$	Reset Output. $\overline{RST}$ is an open-drain output that goes high impedance when the output voltage rises above 90% of the nominal regulation voltage. $\overline{RST}$ pulls low when the output is below 90% of the nominal regulation voltage. $\overline{RST}$ is high impedance during shutdown.
—	—	EP	Exposed Paddle (TDFN Package Only). Connect to the PC board ground plane for increased thermal performance.

# 200mA Step-Up Converters in 6-Pin SOT23 and TDFN

MAX8569A/MAX8569B

## Detailed Description

The MAX8569A and MAX8569B compact high-efficiency step-up converters feature low-quiescent supply current to ensure the highest possible efficiency over a wide load range. With a minimum 1.5V input voltage, these devices are well suited for applications with two alkaline cells, two nickel-metal-hydrate (NiMH) cells, or one lithium-ion (Li+) cell. When SHDN is low, the output is connected to the battery through the inductor and an internal p-channel MOSFET. This allows the input battery to be used as a backup or real-time clock supply when the converter is off by eliminating the voltage drop across the MOSFET body diode. These devices are ideal for low-power applications where a small footprint is critical. The internal synchronous rectifier improves efficiency significantly and reduces size and cost by eliminating the need for an external Schottky diode.

## Control Scheme

The MAX8569A/MAX8569B feature a current-limited control scheme that provides ultra-low quiescent current and high efficiency over a wide output current range. The switching cycles are not controlled by an oscillator.

Instead, switch on-time is terminated when the inductor current reaches the 780mA (typ) n-channel current limit, or when the 5 $\mu$ s maximum n-channel switch on-time is reached. Following each on-cycle, the synchronous rectifier turns on, shunts the MOSFET body diode, and the inductor current ramps to zero before another cycle begins. The next cycle occurs when the error comparator senses that the output has fallen below the regulation threshold.

## Applications Information

### Shutdown

Drive  $\overline{\text{SHDN}}$  low to shut down the MAX8569A/MAX8569B and reduce the input current to less than 1 $\mu$ A. During shutdown, the battery input is connected to the output through the inductor and the internal synchronous rectifier. This allows the input battery (rather than a separate backup battery) to provide backup power for devices such as an idled microcontroller, SRAM, or real-time clock, without the usual diode forward drop. Drive SHDN to  $V_{\text{OUT}}$  (logic-high) to enable the IC for normal operation.

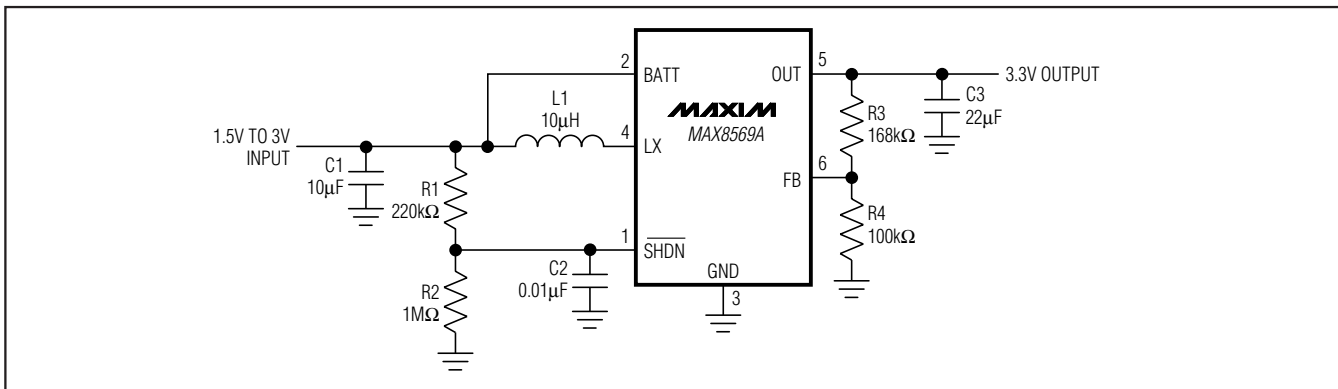

Figure 1. Typical Application Circuit for MAX8569A

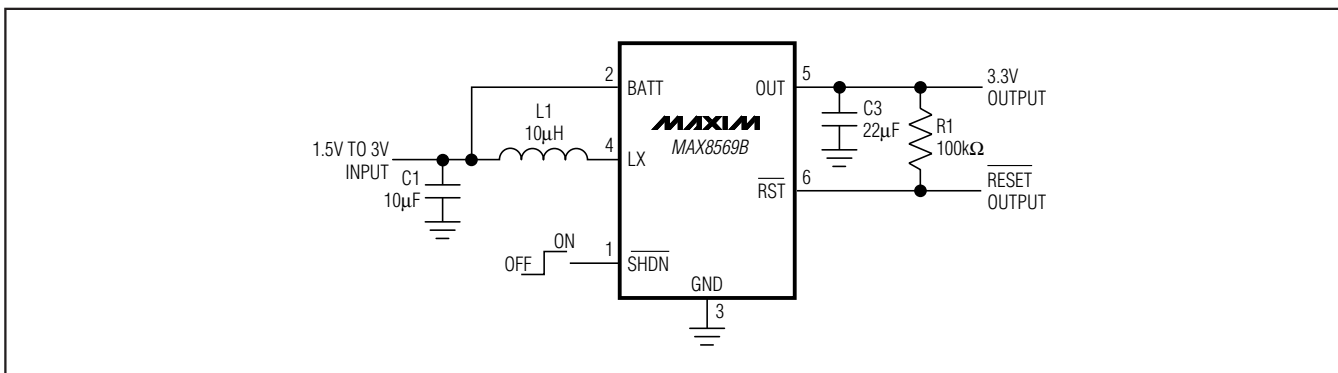

Figure 2. Typical Application Circuit for MAX8569B

## 200mA Step-Up Converters in 6-Pin SOT23 and TDFN

### Low-Battery Cutoff

The  $\overline{\text{SHDN}}$  trip threshold of the MAX8569A/MAX8569B can be used as an input voltage detector that disables the IC when the battery voltage falls to a set level. The  $\overline{\text{SHDN}}$  trip threshold is 1.228V. Use a resistor-divider to set the battery-detection voltage (R1 and R2 in Figure 1). Select R2 between 100k $\Omega$  and 1M $\Omega$  to minimize battery drain. Calculate R1 as follows:

$$R1 = R2 \times ((V_{\text{OFF}} / V_{\overline{\text{SHDN}}} - 1))$$

where  $V_{\text{OFF}}$  is the battery voltage at which the part shuts down and  $V_{\overline{\text{SHDN}}} = 1.228\text{V}$ . Note that input ripple can sometimes cause false shutdowns. To minimize the effect of ripple, connect a low-value capacitor (C2) from  $\overline{\text{SHDN}}$  to GND to filter out input noise. Select a C2 value so the R1, C2 time constant is above 2ms.

### Power-On Reset ( $\overline{\text{RST}}$ , MAX8569B)

The MAX8569B provides a power-on reset output ( $\overline{\text{RST}}$ ) that goes high impedance when the output reaches 90% of its regulation point.  $\overline{\text{RST}}$  pulls low when the output is below 90% of the regulation point. Connect a 100k $\Omega$  to 1M $\Omega$  pullup resistor from  $\overline{\text{RST}}$  to OUT to provide a logic control signal for a microprocessor. Connect  $\overline{\text{RST}}$  to GND when the reset function is not used.

### Setting the Output Voltage (MAX8569A)

The output of the MAX8569A is adjustable from 2V to 5.5V. Connect a resistor-divider from the output to ground with FB connected to the center tap to set the desired output voltage (R3 and R4, Figure 1). Select R4 between 100k $\Omega$  and 1M $\Omega$ . R3 is then calculated as follows:

$$R3 = R4 \times ((V_{\text{OUT}} / V_{\text{FB}}) - 1)$$

where  $V_{\text{OUT}}$  is the desired output voltage and  $V_{\text{FB}}$  is 1.228V.

### Inductor Selection

The control scheme of the MAX8569A/MAX8569B permits flexibility in choosing an inductor. A 10 $\mu\text{H}$  inductor performs well for most applications, but values from 4.7 $\mu\text{H}$  to 100 $\mu\text{H}$  can be used as well. Small inductance values typically offer smaller physical size. Output power is reduced when the inductance is large enough to prevent the maximum current limit (780mA) from being reached before the maximum on-time (5 $\mu\text{s}$ ) expires. For maximum output current, choose L so that:

$$\frac{V_{\text{BATT(MAX)}} \times 1\mu\text{s}}{0.78\text{A}} < L < \frac{V_{\text{BATT(MIN)}} \times 5\mu\text{s}}{0.78\text{A}}$$

$$I_{\text{OUT(MAX)}} = \frac{0.78\text{A}}{2} \times \left( V_{\text{BATT(MIN)}} - \frac{0.78\text{A}}{2} \times (R_{\text{NCH}} + R_{\text{L}}) \right) / V_{\text{OUT}}$$

where  $R_{\text{L}}$  is the inductor series resistance and  $R_{\text{NCH}}$  is the  $R_{\text{DS(ON)}}$  of the internal n-channel MOSFET (0.3 $\Omega$  typ).

### Capacitor Selection

Choose an output capacitor to achieve the desired output ripple percentage.

$$C_{\text{OUT}} > (0.5 \times L \times 0.780\text{A}^2) / (r\% \times V_{\text{OUT}}^2)$$

where L is the inductor value and r is the desired output ripple in %. A 22 $\mu\text{F}$  ceramic capacitor is a good starting value.

The input capacitor reduces the peak current drawn from the battery and can be the same value as the output capacitor. A larger input capacitor can be used to further reduce the input ripple and improve efficiency.

### PC Board Layout and Grounding

Careful printed circuit layout is important for minimizing ground bounce and noise. Keep the IC's GND pin and the ground leads of the input- and output-filter capacitors less than 0.2in (5mm) apart. In addition, keep all connections to the FB and LX pins as short as possible. In particular, when using external feedback resistors, locate them as close to FB as possible. To maximize output power and efficiency and minimize output ripple voltage, use a ground plane and solder the IC's GND directly to the ground plane. A sample layout is available in the MAX8569A/MAX8569B evaluation kit to speed designs.

## Chip Information

PROCESS: BiCMOS

## Selector Guide

PART	OUTPUT VOLTAGE	PIN-PACKAGE	TOP MARK
MAX8569AEUT	Adjustable	SOT23-6	ABWK
MAX8569BEUT	Fixed 3.3V	SOT23-6	ABWL
MAX8569AETT	Adjustable	TDFN	AJN
MAX8569BETT	Fixed 3.3V	TDFN	AJO
MAX8569BETT30	Fixed 3.0V	TDFN	AJP



# 200mA Step-Up Converters in 6-Pin SOT23 and TDFN

## Package Information

(The package drawing(s) in this data sheet may not reflect the most current specifications. For the latest package outline information go to [www.maxim-ic.com/packages](http://www.maxim-ic.com/packages).)

**MAX8569A/MAX8569B**

6, 8, & 10L; DFN THINLEPS

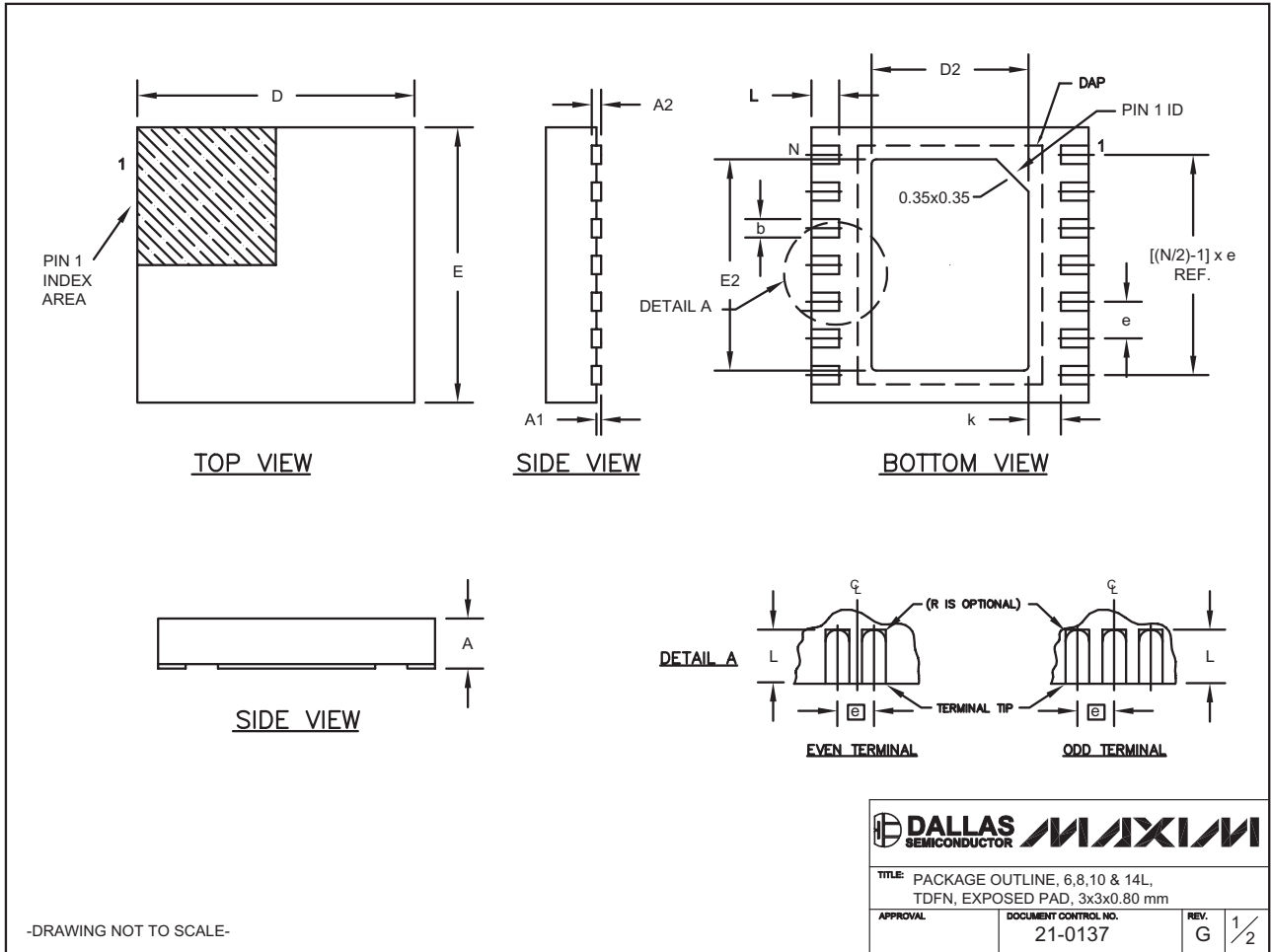

# 200mA Step-Up Converters in 6-Pin SOT23 and TDFN

## Package Information (continued)

(The package drawing(s) in this data sheet may not reflect the most current specifications. For the latest package outline information go to [www.maxim-ic.com/packages](http://www.maxim-ic.com/packages).)

COMMON DIMENSIONS		
SYMBOL	MIN.	MAX.
A	0.70	0.80
D	2.90	3.10
E	2.90	3.10
A1	0.00	0.05
L	0.20	0.40
k	0.25 MIN.	
A2	0.20 REF.	

PACKAGE VARIATIONS								
PKG. CODE	N	D2	E2	e	JEDEC SPEC	b	[(N/2)-1] x e	DOWNBONDS ALLOWED
T633-1	6	1.50-0.10	2.30-0.10	0.95 BSC	MO229 / WEEA	0.40-0.05	1.90 REF	NO
T633-2	6	1.50-0.10	2.30-0.10	0.95 BSC	MO229 / WEEA	0.40-0.05	1.90 REF	NO
T833-1	8	1.50-0.10	2.30-0.10	0.65 BSC	MO229 / WEEC	0.30-0.05	1.95 REF	NO
T833-2	8	1.50-0.10	2.30-0.10	0.65 BSC	MO229 / WEEC	0.30-0.05	1.95 REF	NO
T833-3	8	1.50-0.10	2.30-0.10	0.65 BSC	MO229 / WEEC	0.30-0.05	1.95 REF	YES
T1033-1	10	1.50-0.10	2.30-0.10	0.50 BSC	MO229 / WEED-3	0.25-0.05	2.00 REF	NO
T1433-1	14	1.70-0.10	2.30-0.10	0.40 BSC	----	0.20-0.05	2.40 REF	YES
T1433-2	14	1.70-0.10	2.30-0.10	0.40 BSC	----	0.20-0.05	2.40 REF	NO

**NOTES:**

1. ALL DIMENSIONS ARE IN mm. ANGLES IN DEGREES.
2. COPLANARITY SHALL NOT EXCEED 0.08 mm.
3. WARPAGE SHALL NOT EXCEED 0.10 mm.
4. PACKAGE LENGTH/PACKAGE WIDTH ARE CONSIDERED AS SPECIAL CHARACTERISTIC(S).
5. DRAWING CONFORMS TO JEDEC MO229, EXCEPT DIMENSIONS "D2" AND "E2", AND T1433-1 & T1433-2.
6. "N" IS THE TOTAL NUMBER OF LEADS.
7. NUMBER OF LEADS SHOWN ARE FOR REFERENCE ONLY.

-DRAWING NOT TO SCALE-

	
TITLE: PACKAGE OUTLINE, 6,8,10 & 14L, TDFN, EXPOSED PAD, 3x3x0.80 mm	
APPROVAL	DOCUMENT CONTROL NO. 21-0137
REV. G	2/2