



MAX8654 Evaluation Kit

General Description

The MAX8654 evaluation kit (EV kit) is a fully assembled and tested PCB that demonstrates the capabilities of the MAX8654 integrated 8A step-down regulator. The EV kit generates a 3.3V output voltage at load currents up to 8A from a 4.5V to 14V input voltage range. The MAX8654 switches at 500kHz and provides over 93.4% efficiency with the supplied components.

Component Suppliers

SUPPLIER	PHONE	WEBSITE
Murata Electronics North America, Inc.	770-436-1300	www.murata-northamerica.com
Taiyo Yuden	800-348-2496	www.t-yuden.com
TDK Corp.	847-803-6000	www.component.tdk.com
TOKO America, Inc.	847-297-0070	www.tokoam.com

Note: Indicate that you are using the MAX8654 when contacting these component suppliers.

Features

- ◆ Internal 26mΩ R_{DS(ON)} MOSFETs
- ◆ Guaranteed 8A Output Current
- ◆ Adjustable Over-Current Protection, 6A to 12A
- ◆ ±1% Output Accuracy Over Load, Line, and Temperature
- ◆ Operates from 4.5V to 14V Supply
- ◆ Adjustable Output from 0.6V to 0.85 x V_{IN}
- ◆ Soft-Start Reduces Inrush Supply Current
- ◆ 250kHz to 1.2MHz Adjustable Switching or SYNC Input
- ◆ Compatible with Ceramic, Polymer, and Electrolytic Output Capacitors
- ◆ SYNCOUT Synchronizes 2nd Regulator 180° Out-of-Phase
- ◆ 36-Pin 6mm x 6mm TQFN Package

Ordering Information

PART	TEMP RANGE	IC PACKAGE
MAX8654EVKIT+	0°C to +70°C	36 TQFN (6mm x 6mm)

+Denotes a lead-free and RoHS-compliant EV kit.

Component Lists

MAX8654 Circuit

DESIGNATION	QTY	DESCRIPTION
C1A, C1B, C1C	3	10µF ±20%, 16V X5R ceramic capacitors (1206) Taiyo Yuden EMK316BJ106M
C2	1	1µF ±10%, 6.3V X5R ceramic capacitor (0402) Murata GRM155R60J105K
C3, C11	2	0.01µF ±10%, 50V X7R ceramic capacitors (0402) Murata GRM155R71H103K
C4	1	0.22µF ±20%, 16V X7R ceramic capacitor (0603) TDK C1608X7R1C224M
C5A, C5B, C5C	3	22µF ±20%, 6.3V X5R ceramic capacitors (1206) TDK C3216X5R0J226M
C6	1	6800pF ±10%, 50V X7R ceramic capacitor (0402) Murata GRM155R71H682KA88
C7	1	0.022µF, 10V X7R ceramic capacitor (0402) Murata GRM155R71C223CKA01

DESIGNATION	QTY	DESCRIPTION
C8	1	1000pF, 50V C0G ceramic capacitor (0402) Murata GRM1555C1H1D2TADI
C9	1	4.7µF ±10%, 16V X5R ceramic capacitor (0603) Murata GRM21BR61C475K
C10	1	0.22µF, 16V Y5R ceramic capacitor (0402) Taiyo Yuden EMK105BJ224MV-F
C12	1	470pF ±10%, 50V X7R ceramic capacitor (0402) Murata GRM155R71H471K
C13	1	0.1µF ±10%, 10V X7R ceramic capacitor (0402) Murata GRM155R61A104K
C14, C15	2	0.22µF ±20%, 50V X5R ceramic capacitors (0805) Taiyo Yuden UMK212BJ224M
C16	0	Not installed, 0.01µF ±10%, 25V X7R ceramic capacitor (0402) Murata GRM155R71E103K



MAX8654 Evaluation Kit

Component Lists (continued)

MAX8654 Circuit

DESIGNATION	QTY	DESCRIPTION
JP1–JP7, JP9–JP13	0	Not installed
JU1, JU2, JU4	3	2-pin headers
JU3	1	3-pin header
L1	1	1 μ H, 7.9m Ω , 12A inductor (7.4mm x 6.7mm x 3mm) TOKO FDV0630-1R0M
R1, R2, R10	3	100k Ω \pm 1% resistors (0402), lead free
R3	1	1.5k Ω \pm 1% resistor (0402), lead free
R4	1	332 Ω \pm 1% resistor (0402), lead free
R5	1	15 Ω \pm 5% resistor (0402), lead free
R6	1	475 Ω \pm 1% resistor (0402), lead free
R7	1	75k Ω \pm 1% resistor (0402), lead free
R8	1	2.2 Ω \pm 1% resistor (1206), lead free
R9, R11	2	1k Ω \pm 1% resistors (0402), lead free
R12	1	10 Ω \pm 1% resistor (0402), lead free
U1	1	8A step-down regulator Maxim MAX8654ETX+
—	3	Shunts
—	1	PCB: MAX8654 Evaluation Kit+

MAX8688 Circuit—Not Installed

DESIGNATION	QTY	DESCRIPTION
C201, C202, C203, C205, C206, C207	0	100nF \pm 10%, 50V X7R ceramic capacitors (0603), open Murata GRM188R71H104K
C204	0	1 μ F \pm 10%, 10V X5R ceramic capacitor (0603), open Murata GRM188R61A105K
C208	0	2.2 μ F \pm 10%, 10V X5R ceramic capacitor (0603), open Taiyo Yuden LMK107BJ225K
C209	0	Ceramic capacitor, open
C210	0	0.47 μ F \pm 10%, 10V X5R ceramic capacitor (0603), open Murata GRM188R61A474K
D1	0	3.3V 350mW zener diode (SOT23), open Central Semiconductor CMPZ4620
JP201	0	4-pin header, open
JP202, JP203, JP204	0	3-pin header, open
R19	0	100k Ω resistor, open

MAX8688 Circuit—Not Installed

DESIGNATION	QTY	DESCRIPTION
R201, R204, R206, R208, R209, R214	0	Resistors, open
R202	0	0 Ω resistor (0402)
R203	0	1k Ω \pm 1% resistor (0402), open
R205, R207, R210	0	33k Ω \pm 1% resistors (0402), open
R211	0	909 Ω \pm 5% resistor (0603), open
R213	0	100k Ω \pm 1% resistor (0402), open
R215	0	10k Ω \pm 1% resistor (0402), open
R216, R217	0	100 Ω \pm 1% resistors (0402), open
U201	0	MAX8688+, open
U202	0	AT24C01A-10TSU-1.8, open

Quick Start

Recommended Equipment

Before beginning, the following equipment is needed:

- Up to 12V at +3A DC power supply or battery
- Digital multimeter (DMM)
- Up to 8A load
- Ammeter (optional)

Procedure

The MAX8654 EV kit is fully assembled and tested. Follow the steps below to verify board operation. **Caution:** Do not turn on the power supply until all connections are made.

- 1) Preset the DC power supply to 12V. Turn off the power supply.
- 2) Ensure that there is a shunt on JU1 and JU2.
- 3) Ensure that there is a shunt on pins 1-2 of JU3.
- 4) Connect the positive lead of the power supply to the VIN pad and connect the negative lead of the power supply to the GND pad on the EV kit.
- 5) Connect the positive lead of the DMM to the VOUT pad and connect the negative lead of the DMM to the GND pad on the EV kit.
- 6) Turn on the power supply.
- 7) Verify that the voltage at VOUT is approximately 3.3V.
- 8) Connect the load between VOUT and GND.
- 9) Verify that the voltage at VOUT is approximately 3.3V.

MAX8654 Evaluation Kit

Evaluates: MAX8654/MAX8688

Detailed Description of Hardware

Evaluating Other Switching Frequencies (FREQ)

The switching frequency in fixed-frequency PWM operation is resistor-programmable from 250kHz to 1.2MHz. Set the switching frequency of the IC with a resistor (RFREQ) from FREQ to GND. RFREQ is calculated as:

$$R_{FREQ} = 52.36 \times \left(\frac{1}{f_s} - 0.05\mu\text{s} \right) \text{ k}\Omega$$

where f_s is the desired switching frequency in megahertz.

Undervoltage Lockout (UVLO)

The UVLO circuitry inhibits switching when V_{IN} or V_{VDL} is below 4.4V (V_{IN} , V_{VDL} rising) or V_{VL} is below 3.1V (V_{VL} rising). Once these voltages are above the thresholds, UVLO clears and the soft-start function activates. A 100mV hysteresis is built in for glitch immunity.

Power Good (PWRGD)

PWRGD is an open-drain output that goes high impedance once the soft-start ramp has concluded, provided V_{FB} and V_{REFIN} are above 0.54V. PWRGD pulls low when V_{FB} falls below 0.54V for at least 50 μs or V_{REFIN} is less than 0.54V. PWRGD is low during shutdown.

SYNC and SYNCOUT

The MAX8654 features a SYNC function that allows the switching frequency to be synchronized to any external clock frequency that is higher than the internal clock frequency. Drive SYNC with a square wave at the desired synchronization frequency. A rising edge on SYNC triggers the internal SYNC circuitry. Connect SYNC to GND to disable the function and operate with the internal oscillator. The SYNCOUT output generates a clock signal that is 180° out-of-phase with its internal oscillator, or the signal applied to SYNC. This allows for another MAX8654 to be synchronized 180° out-of-phase to reduce the input ripple current.

Soft-Start and REFIN

The MAX8654 utilizes an adjustable soft-start function to limit inrush current during startup. An 8 μA (typ) current source charges an external capacitor (C3) connected to SS to increase the capacitor voltage in a controlled manner. The soft-start time is adjusted by the value of the external capacitor from SS to GND. The required capacitance value is determined as:

$$C = \frac{8\mu\text{A} \times t_{SS}}{0.6\text{V}}$$

where t_{SS} is the required soft-start time in seconds.

The MAX8654 also features an external reference input (REFIN). The IC regulates FB to the voltage applied to REFIN. The internal soft-start is not available when using an external reference. A method of soft-start when using an external reference is shown in the MAX8654 data sheet. Connect REFIN to SS to use the internal 0.6V reference (jumper JU3).

Jumper Settings

Jumper JU1 Function

Drive EN high by placing a shunt on JU1 to turn on the IC. To shut down the IC and reduce quiescent current to 10 μA (typ), remove the shunt on JU1. During shutdown, the outputs of the MAX8654 are high impedance.

Jumper JU2 Function

Place a shunt on jumper JU2 to connect SYNC to GND.

Jumper JU3 Function

Place a shunt on pins 1-2 of JU3 to connect the REFIN pin to the SS pin. When using an external reference, place a shunt on pins 2-3 of jumper JU3.

Evaluating the MAX8688

The MAX8688 is a fully digital power-supply manager that can be tested in conjunction with the MAX8654. Samples of the MAX8688 IC can be ordered from Maxim. To test the MAX8688, populate it with its circuitry, as shown by the schematic or in the component list. Also, place a shunt on pins 2-3 of JU3. For further information, refer to the MAX8688 IC data sheet.

MAX8654 Evaluation Kit

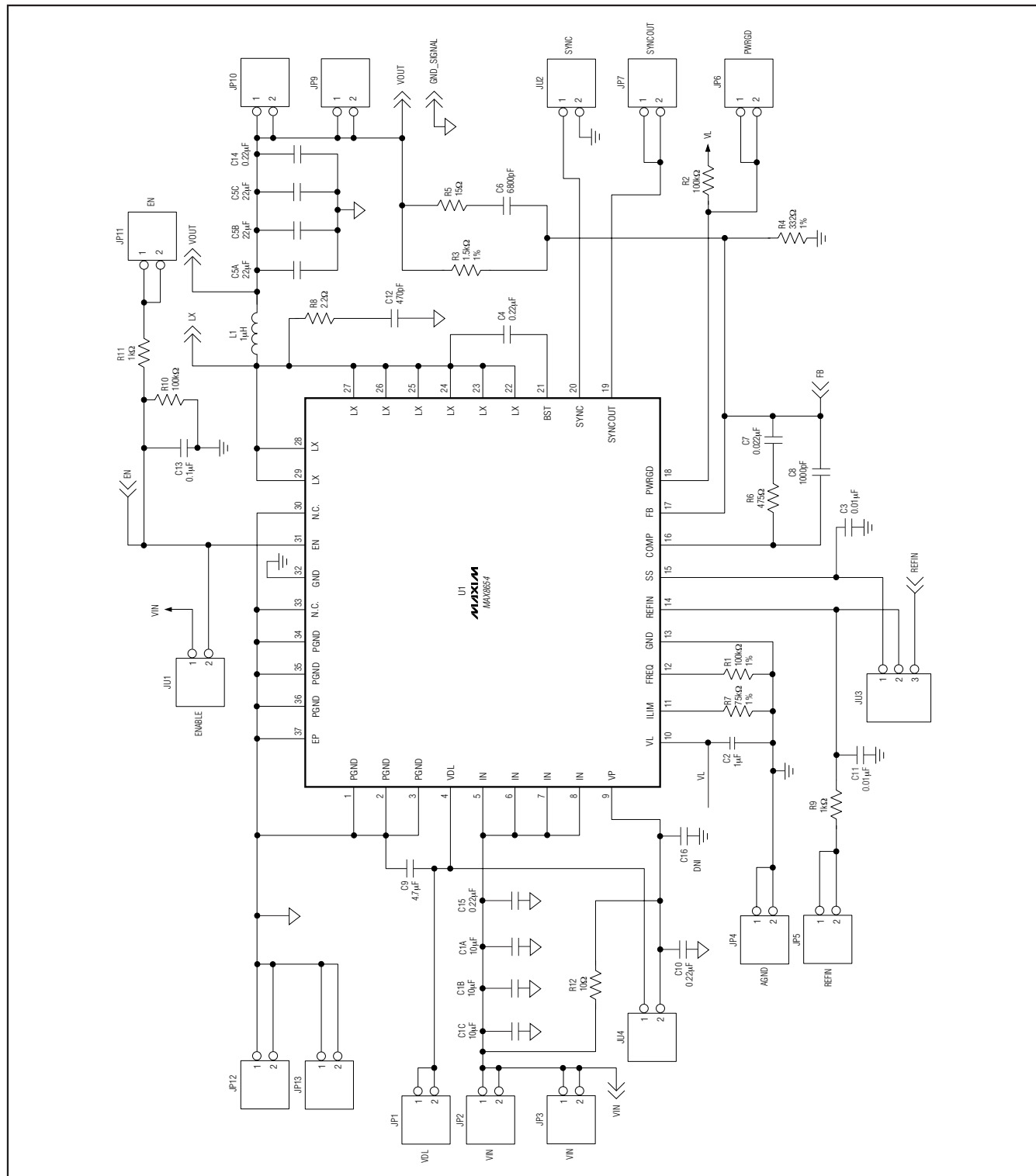

Figure 1a. MAX8654 EV Kit Schematic (Sheet 1 of 2)

MAX8654 Evaluation Kit

Evaluates: MAX8654/MAX8688

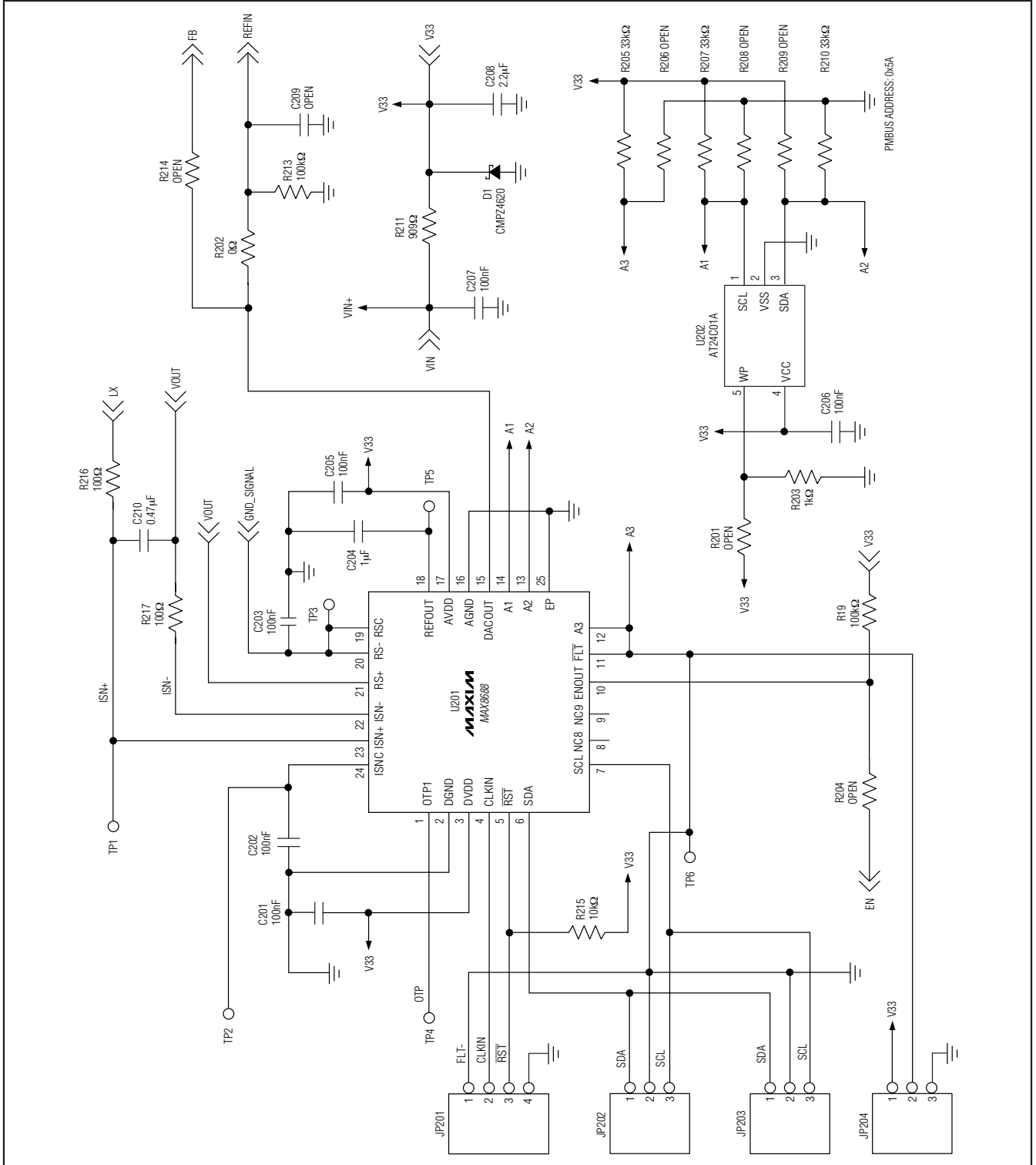

Figure 1b. MAX8654 EV Kit Schematic (Sheet 2 of 2)

MAX8654 Evaluation Kit

Evaluates: MAX8654/MAX8688

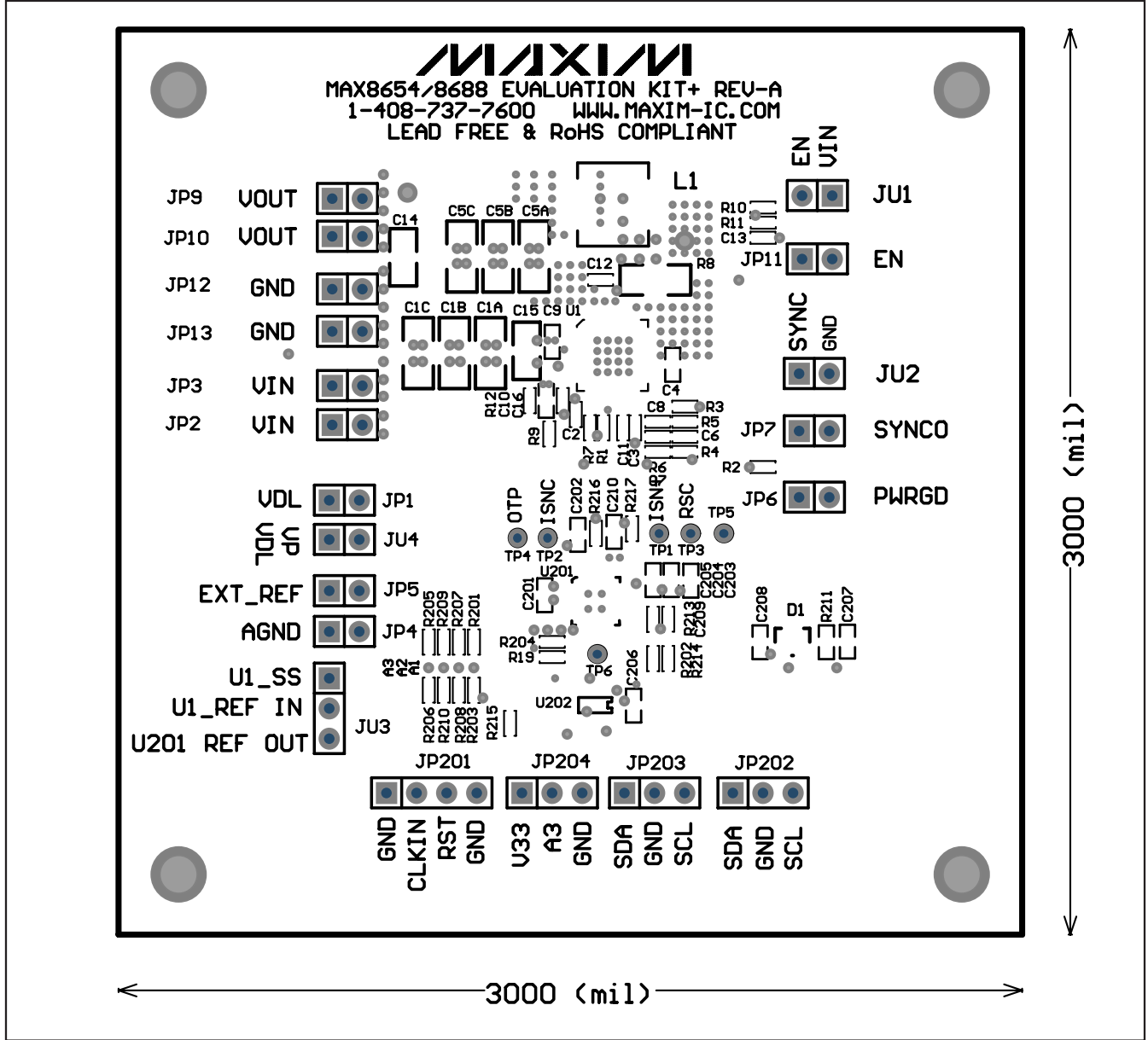

Figure 2. MAX8654 EV Kit Component Placement Guide—Component Side

MAX8654 Evaluation Kit

Evaluates: MAX8654/MAX8688

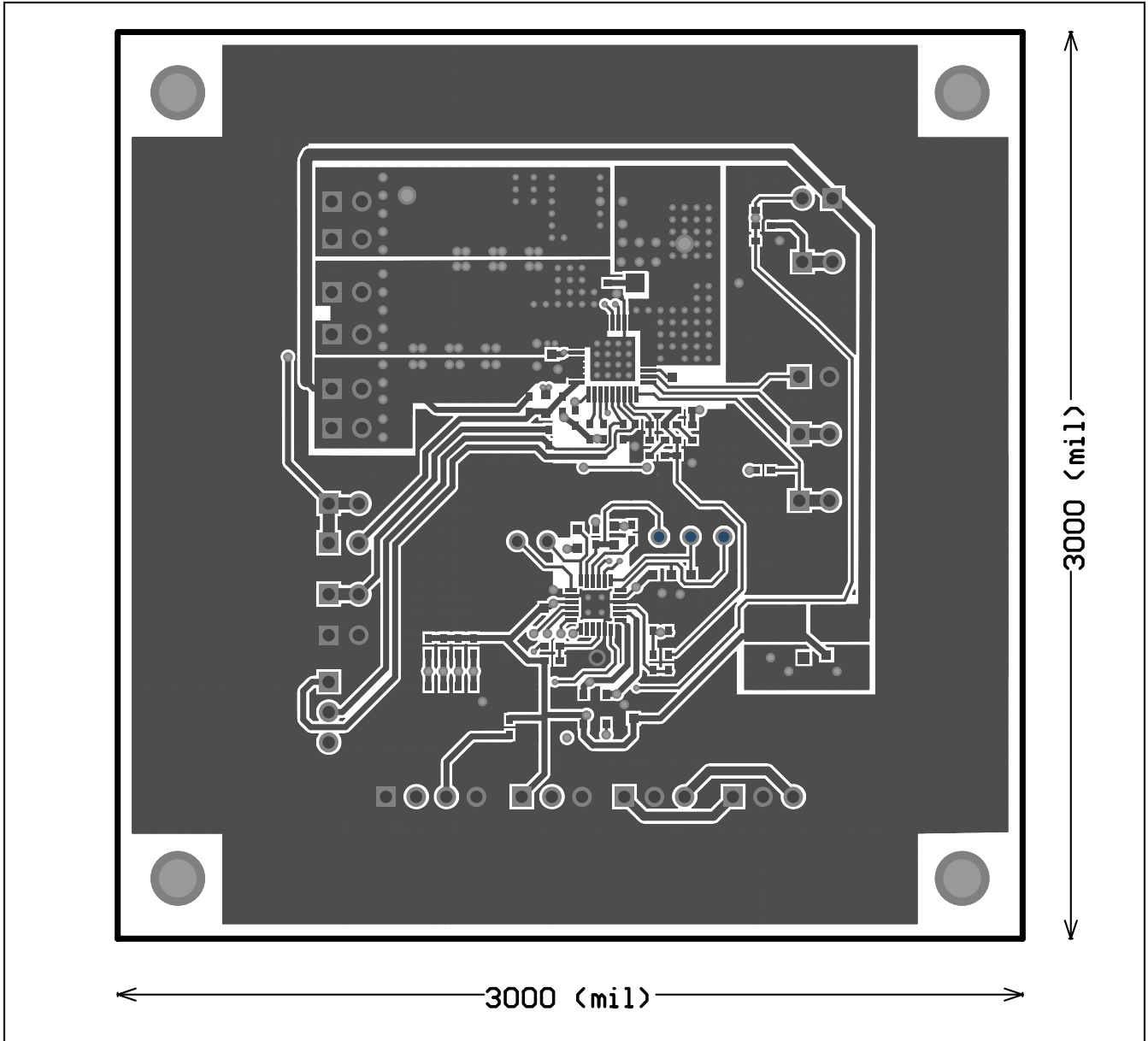

Figure 3. MAX8654 EV Kit PCB Layout—Component Side

MAX8654 Evaluation Kit

Evaluates: MAX8654/MAX8688

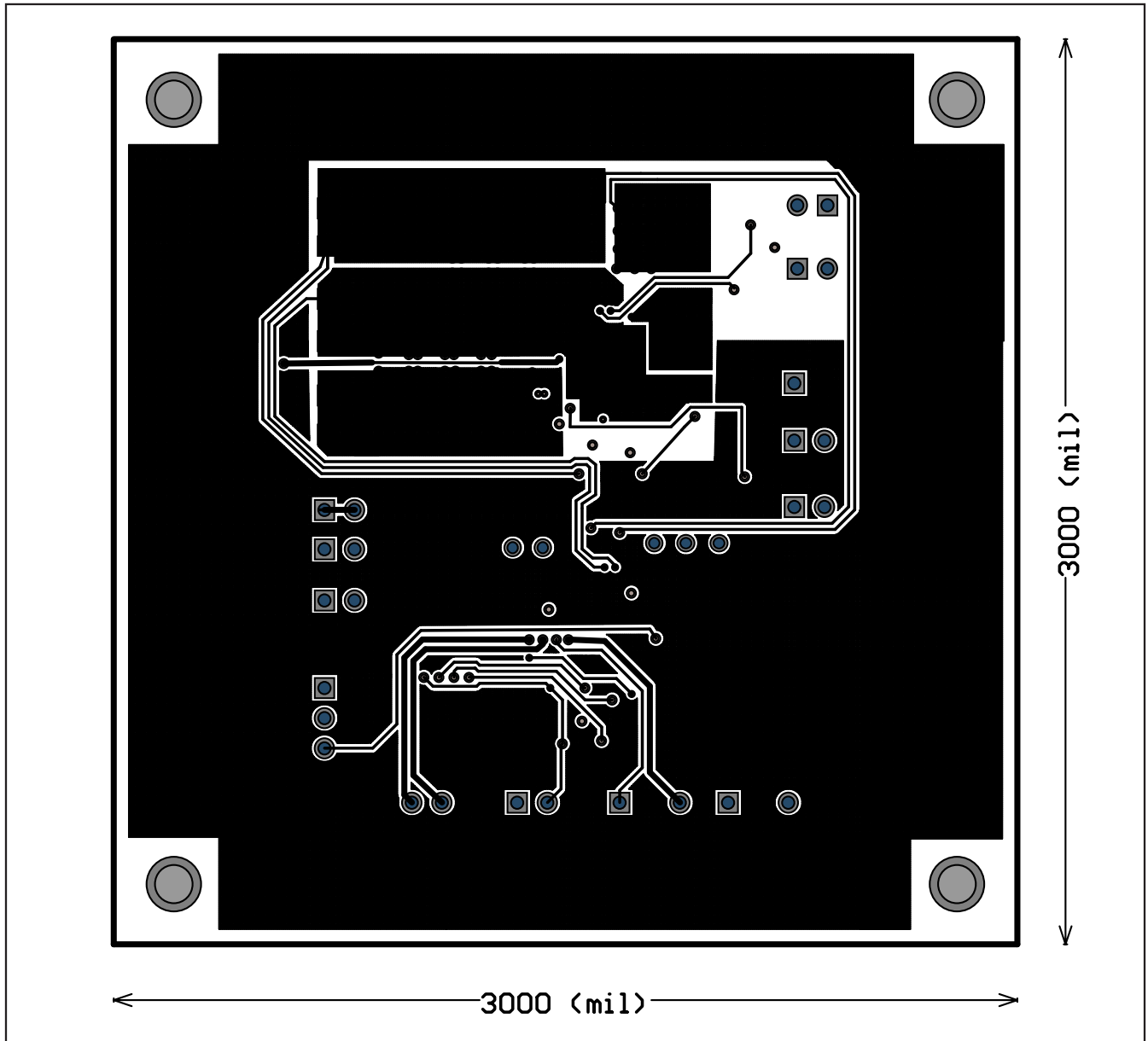

Figure 4. MAX8654 EV Kit PCB Layout—Inner Layer 1

MAX8654 Evaluation Kit

Evaluates: MAX8654/MAX8688

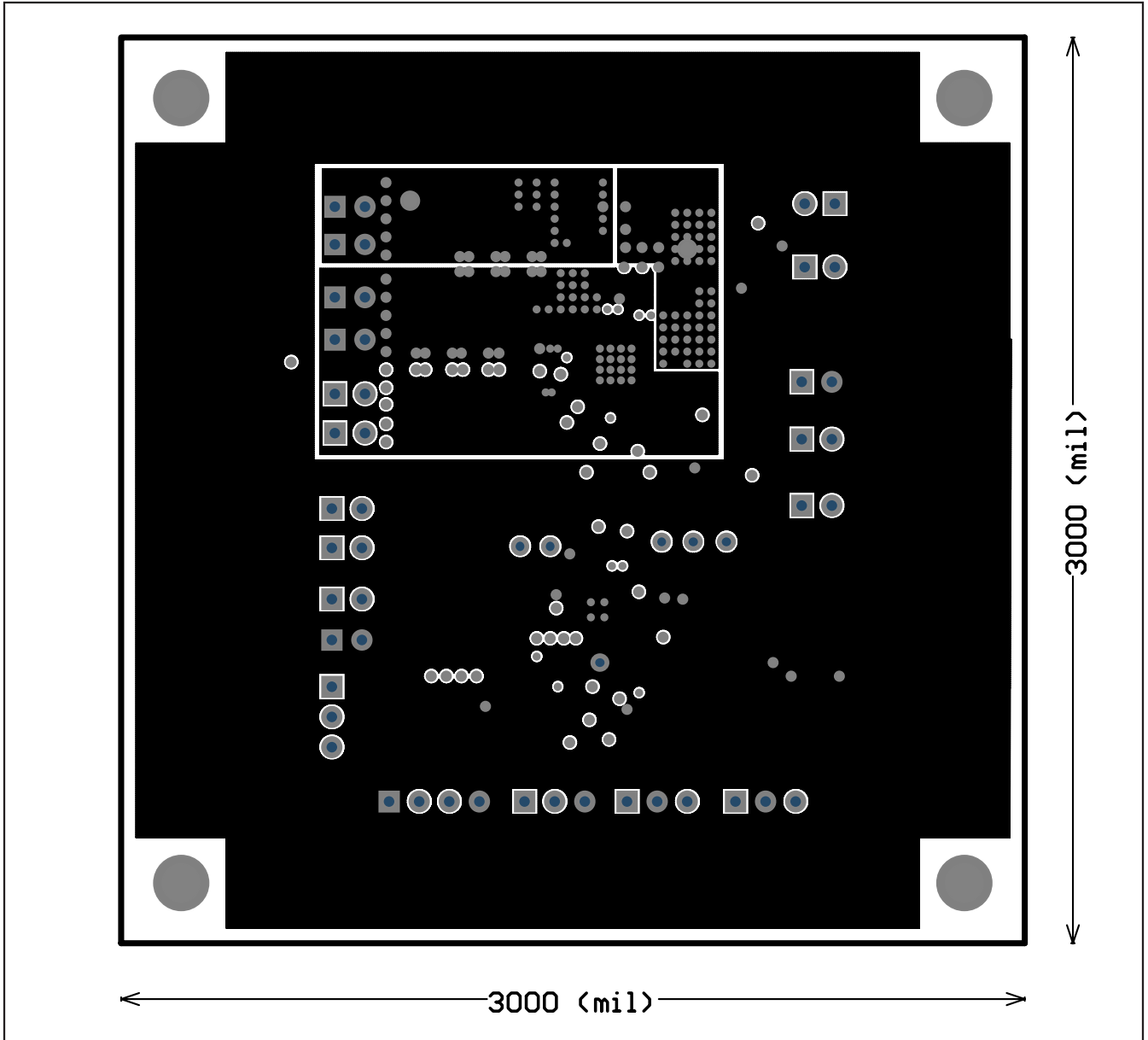

Figure 5. MAX8654 EV Kit PCB Layout—Inner Layer 2

MAX8654 Evaluation Kit

Evaluates: MAX8654/MAX8688

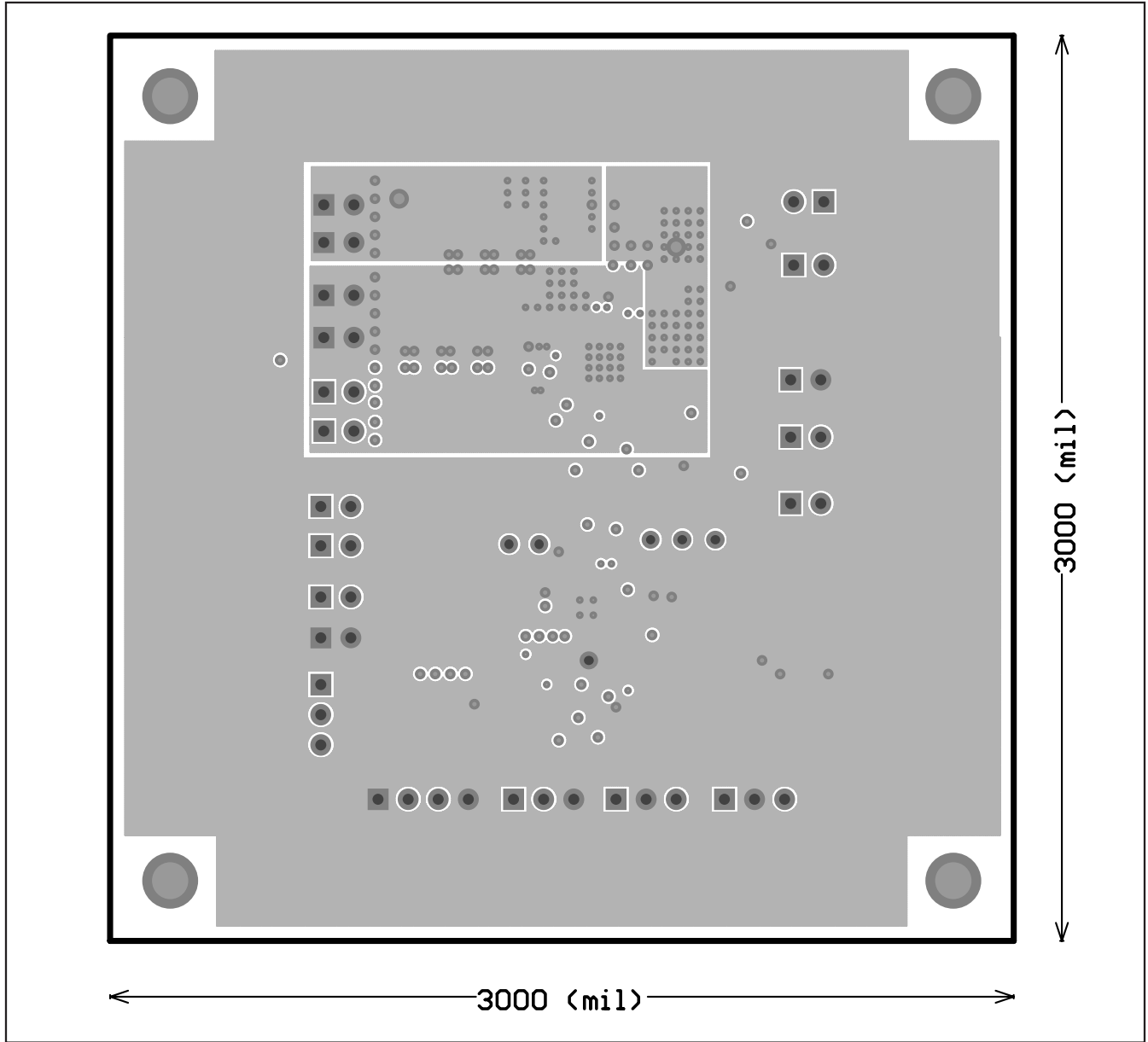

Figure 6. MAX8654 EV Kit PCB Layout—Inner Layer 3

MAX8654 Evaluation Kit

Evaluates: MAX8654/MAX8688

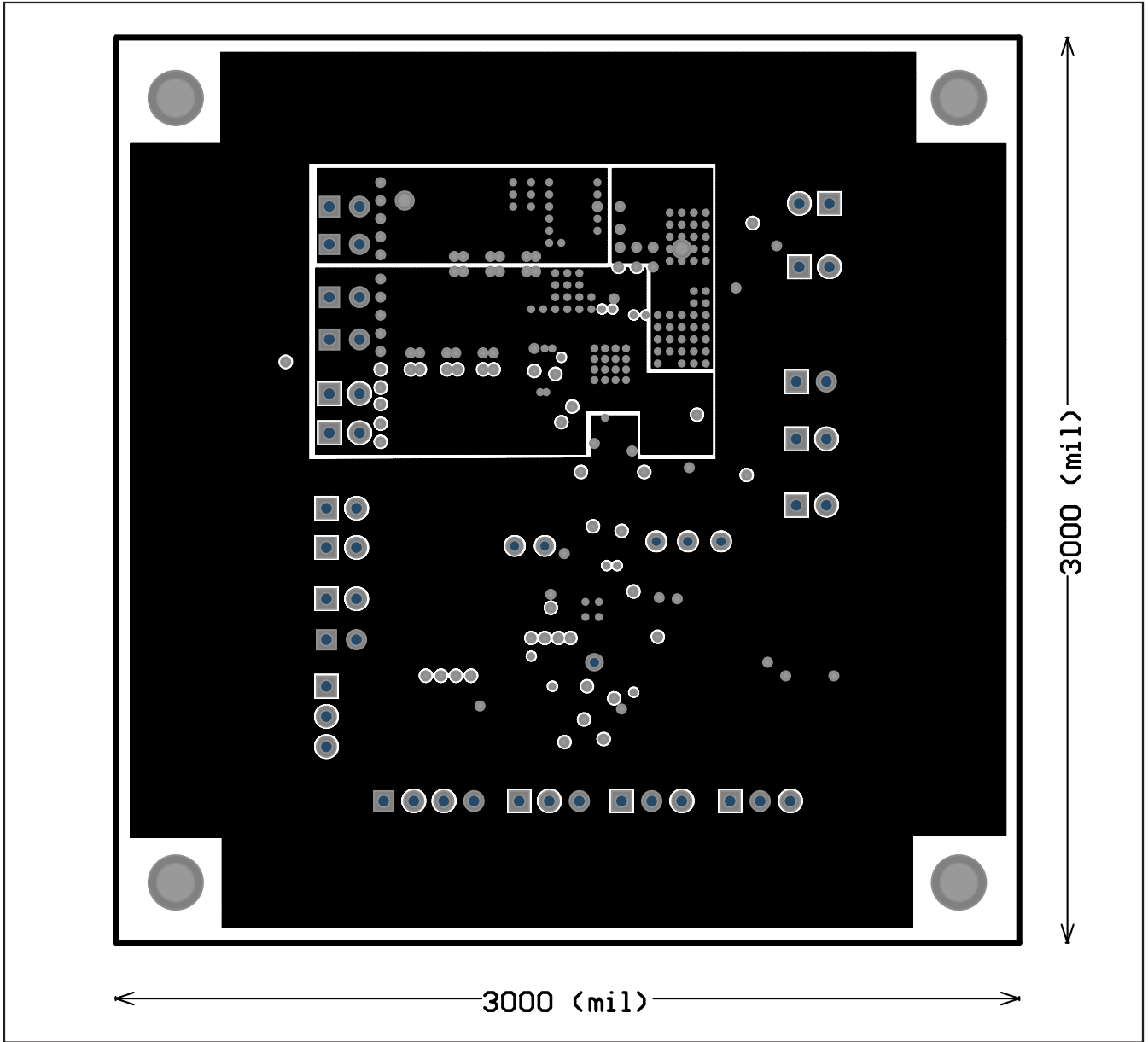

Figure 7. MAX8654 EV Kit PCB Layout—Inner Layer 4

MAX8654 Evaluation Kit

Evaluates: MAX8654/MAX8688

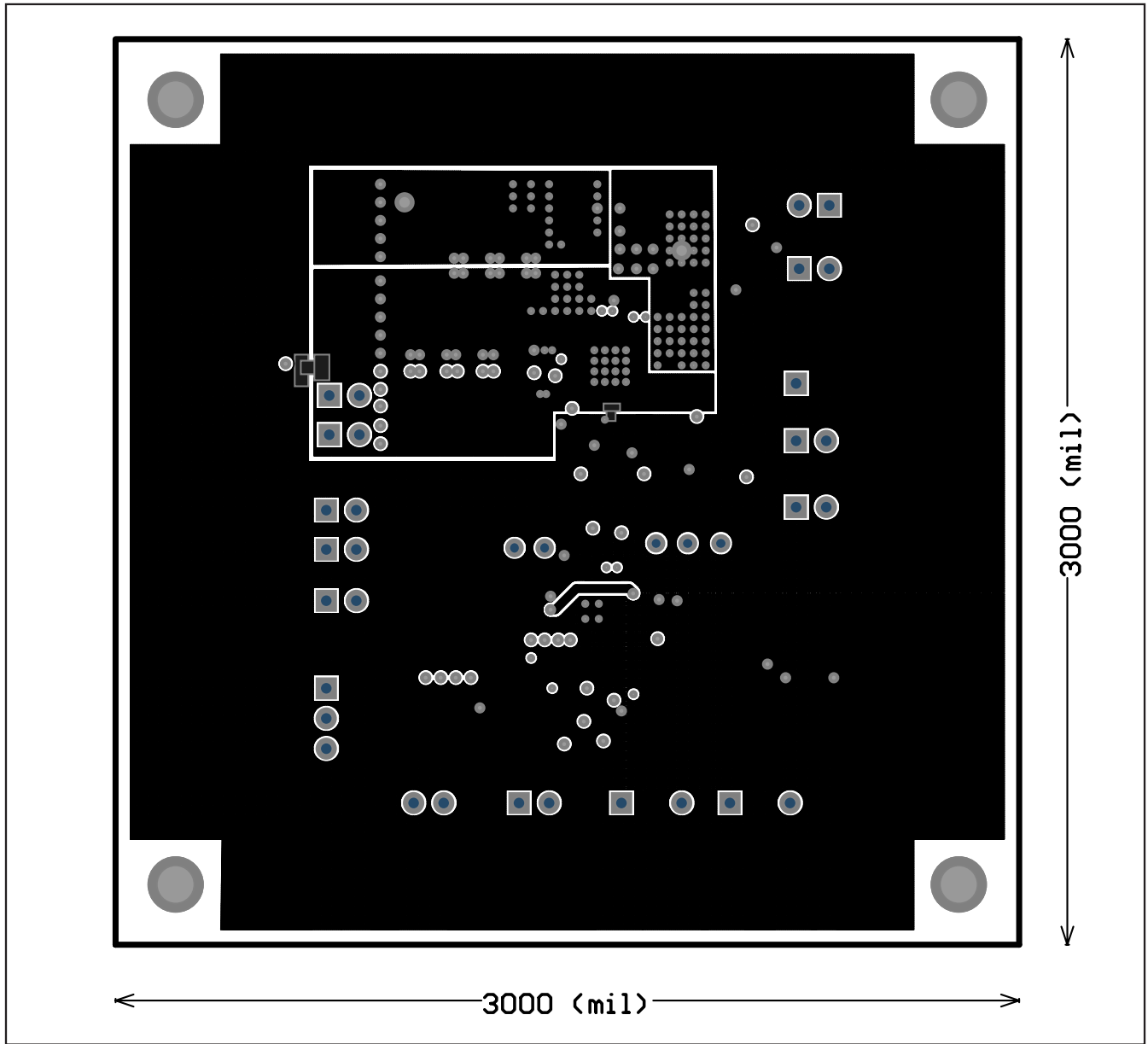

Figure 8. MAX8654 EV Kit PCB Layout—Solder Side