



# MAX8713 Evaluation Kit/Evaluation System

## General Description

The MAX8713 evaluation kit (EV kit) is an efficient, multichemistry battery charger. It uses the Intel system management bus (SMBus™) to control the battery regulation voltage and charger current output.

The MAX8713 EV kit can charge one, two, three, or four series Li+ cells with a current up to 2A.

The MAX8713 evaluation system (EV system) consists of a MAX8713 EV kit and the Maxim SMBUSMON2 board. The MAX8713 EV kit includes Windows® 95-/98-/2000-/XP-compatible software to provide a user-friendly interface.

## Features

- ◆ 0.6% Battery Voltage Accuracy
- ◆ 5% Battery Charge-Current Accuracy
- ◆ Up to 2A Battery Charge Current
- ◆ +8V to +25V Input Voltage Range
- ◆ Charge Li+, NiCd, and NiMH Battery Chemistries
- ◆ Cycle-by-Cycle Current Limiting
- ◆ SMBus-Compatible 2-Wire Serial Interface
- ◆ Includes Windows 95-/98-/2000-/XP-Compatible Software and Demo PC Board
- ◆ Fully Assembled and Tested

## Ordering Information

PART	TEMP RANGE	IC PACKAGE	SMBus INTERFACE TYPE
MAX8713EVKIT	0°C to +70°C	24 Thin QFN, 4mm x 4mm	Not included
MAX8713EVSYS	0°C to +70°C	24 Thin QFN, 4mm x 4mm	SMBUSMON2

**Note:** The MAX8713 EV kit software is provided with the MAX8713EVKIT. However, to use the software, the SMBUSMON2 board is required to interface the EV kit to the computer.

## Component List

DESIGNATION	QTY	DESCRIPTION
C1	1	0.1µF ±10%, 50V X7R (1206) ceramic capacitor Murata GRM319R71H104K TDK C3216X7R1H104K
C2, C6, C8	3	1µF ±10%, 10V X5R (0603) ceramic capacitors Murata GRM188R61A105K TDK C1608X5R1A105K
C3, C4, C10	3	0.01µF ±10%, 50V X7R (0603) ceramic capacitors Murata GRM188R71H103K TDK C1608X7R1H103K
C5, C11	2	22µF ±20%, 25V X5R (1812) ceramic capacitors TDK C4532X5R1E226M

DESIGNATION	QTY	DESCRIPTION
C7, C9	2	0.1µF ±10%, 25V X7R (0603) ceramic capacitors Murata GRM188R71E104K TDK C1608X7R1E104K
C12, C13, C14	0	Not installed, 0603
D1	1	Schottky diode, 3A, 40V SMA Central Semiconductor CMSH3-40MA Diodes Inc. B340A
D2, D3	2	Diodes, 1N4148-type, SOD-123 Diodes Inc. 1N4148W Fairchild Semiconductor MMSD4148
J1	1	2 x 10 right-angle female receptacle
J2	1	Smart-battery header assembly, right angle, keyless, 5 position TYCO Electronics (AMP) 787441-1

SMBus is a trademark of Intel Corp.

Windows is a registered trademark of Microsoft Corp.



**For pricing, delivery, and ordering information, please contact Maxim/Dallas Direct! at 1-888-629-4642, or visit Maxim's website at [www.maxim-ic.com](http://www.maxim-ic.com).**

# MAX8713 Evaluation Kit/Evaluation System

## Component List (continued)

DESIGNATION	QTY	DESCRIPTION
L1	1	22 $\mu$ H, 2.6A, 75m $\Omega$ inductor Sumida CDRH8D43-220NC
N1A, N1B	2	MOSFETs, dual n-channel, 7.5A, 30V, 8-pin SO Fairchild Semiconductor FDS6990A
R1	1	10k $\Omega$ $\pm$ 5% (0603) resistor
R2	1	33 $\Omega$ $\pm$ 5% (0603) resistor
R3	1	100k $\Omega$ $\pm$ 5% (0603) resistor
R4	1	0.04 $\Omega$ $\pm$ 1%, 0.5W (2010) sense resistor Vishay Dale WSL2010 0.040 1.0% IRC LRC-LR2010-01-R040-F
R5–R8	0	Not installed, 0603
U1	1	MAX8713ETG, 24-pin, 4mm x 4mm, thin QFN
None	1	PC board MAX8713 EV kit

## Quick Start

### Recommended Equipment

- DC source to supply the input current to the charger—this source must be capable of supplying a voltage greater than the battery-voltage set point and have sufficient current rating
- Voltmeter
- Smart battery
- Computer running Windows 95, 98, 2000, or XP
- 9-pin serial extension cable
- SMBUSMON2 board

### Procedure

The MAX8713 EV kit is a fully assembled and tested board. Follow the steps below to verify board operation.

**Do not turn on the power supply until all connections are completed. Observe all precautions on the battery manufacturer's data sheet.**

- 1) Set the VPP jumper on the SMBUSMON2 board to VCC5.
- 2) Carefully connect the boards by aligning the 20-pin connector of the MAX8713 EV kit with the 20-pin header of the SMBUSMON2 board. Gently press them together.
- 3) Connect a cable from the computer's serial port to the SMBUSMON2 interface board. Use a straight-through 9-pin female-to-male cable.

- 4) Install the software by running the INSTALL.EXE program. The install program copies the files and creates icons for them in the Windows 95/98/2000/XP Start menu. An uninstall program is included with the software. Click on the UNINSTALL icon to remove the EV kit software from the hard drive.
- 5) Connect power to the SMBUSMON2 board.
- 6) Connect the input-current supply across the ADAPTER\_IN and PGND pads.
- 7) Connect a smart battery to connector J2.
- 8) Turn on the power supply.
- 9) Start the MAX8713 EV kit software.
- 10) Verify current is being delivered to the battery.

## Detailed Description of Software

The MAX8713 program provides easy access to the MAX8713 registers. It is also capable of reading the registers of a smart battery and monitoring SMBus traffic.

Upon execution of the program, the software enables the MAX8713 smart-charger command panel (Figure 1), after which any of the allowed SMBus commands can be sent to the MAX8713. Refer to the MAX8713 data sheet for more information regarding the allowed SMBus commands.

### Smart Charger Command Panel

#### ChargeVoltage()

To issue the ChargeVoltage() command to the MAX8713, enter the desired voltage, in millivolts, into the Charging Voltage edit field and select the adjacent **Write** button.

#### ChargeCurrent()

To issue the ChargeCurrent() command to the MAX8713, enter the desired current, in milliamps, into the Charging Current edit field and select the adjacent **Write** button.

#### ManufacturerID()

ManufacturerID() returns the manufacturer ID (0x004D) from the MAX8713. This command is available through the Other Bitmapped Charger Registers... panel (Figure 2). Select manufacturer ID by picking it from the pull-down list located directly under the Other Bitmapped Charger Registers... label. Issue a ManufacturerID() command by selecting the **Read** button. The returned hexadecimal value is shown at the bottom of the panel.

# MAX8713 Evaluation Kit/Evaluation System

Evaluate: MAX8713

## DeviceID()

DeviceID() returns the device ID (0x0007) from the MAX8713. This command is available through the Other Bitmapped Charger Registers... panel (Figure 2). Select device ID by picking it from the pulldown list located directly under the Other Bitmapped Charger Registers... label. Issue a DeviceID() command by selecting the **Read** button. The returned hexadecimal value is shown at the bottom of the panel.

## Smart-Battery Command Panel

The software is capable of reading the registers of a smart battery. The smart-battery page of the software is shown in Figure 3. The software only reads the registers selected with checkmarks. By default, the registers are automatically read once every 2s. Disable this feature by unselecting the Active Read: Battery checkbox located on the Timer panel. Change the refresh time by entering a new value into the Timer Interval edit box and select the **Set Interval** button. When autorefresh is disabled, read the battery by selecting the **Refresh** button.

## Detailed Description of Hardware

The MAX8713 includes all of the functions necessary to charge a smart battery. The EV kit is capable of charging with a maximum 2.016A current and a maximum 19.2V voltage. For more information on the operation of the MAX8713, refer to the *Detailed Description* section of the MAX8713 data sheet.

## Connecting a Smart Battery

The MAX8713 EV kit includes a five-pin smart-battery connector. To connect a smart battery to the EV kit, turn off power to the EV kit and connect the battery, making sure to correctly orient the connectors.

## Evaluating the MAX8713 Above 25V

To evaluate the MAX8713 with an input voltage greater than 25V (up to 28V), capacitor C5 must be replaced with a higher-voltage-rating part.

## Component Suppliers

SUPPLIER	PHONE	FAX	WEBSITE
Central Semiconductor	631-435-1110	631-435-1824	www.centralsemi.com
Diodes Inc.	805-446-4800	805-446-4850	www.diodes.com
Fairchild Semiconductor	888-522-5372	—	www.fairchildsemi.com
International Resistive Co. (IRC)	361-992-7900	361-992-3377	www.irctt.com
Murata	770-436-1300	770-436-3030	www.murata.com
Sumida	847-545-6700	847-545-6720	www.sumida.com
TDK	847-803-6100	847-390-4405	www.component.tdk.com
Vishay Dale	402-564-3131	402-563-6296	www.vishay.com

**Note:** Indicate you are using the MAX8713 when contacting these manufacturers.

# MAX8713 Evaluation Kit/Evaluation System

Evaluate: MAX8713

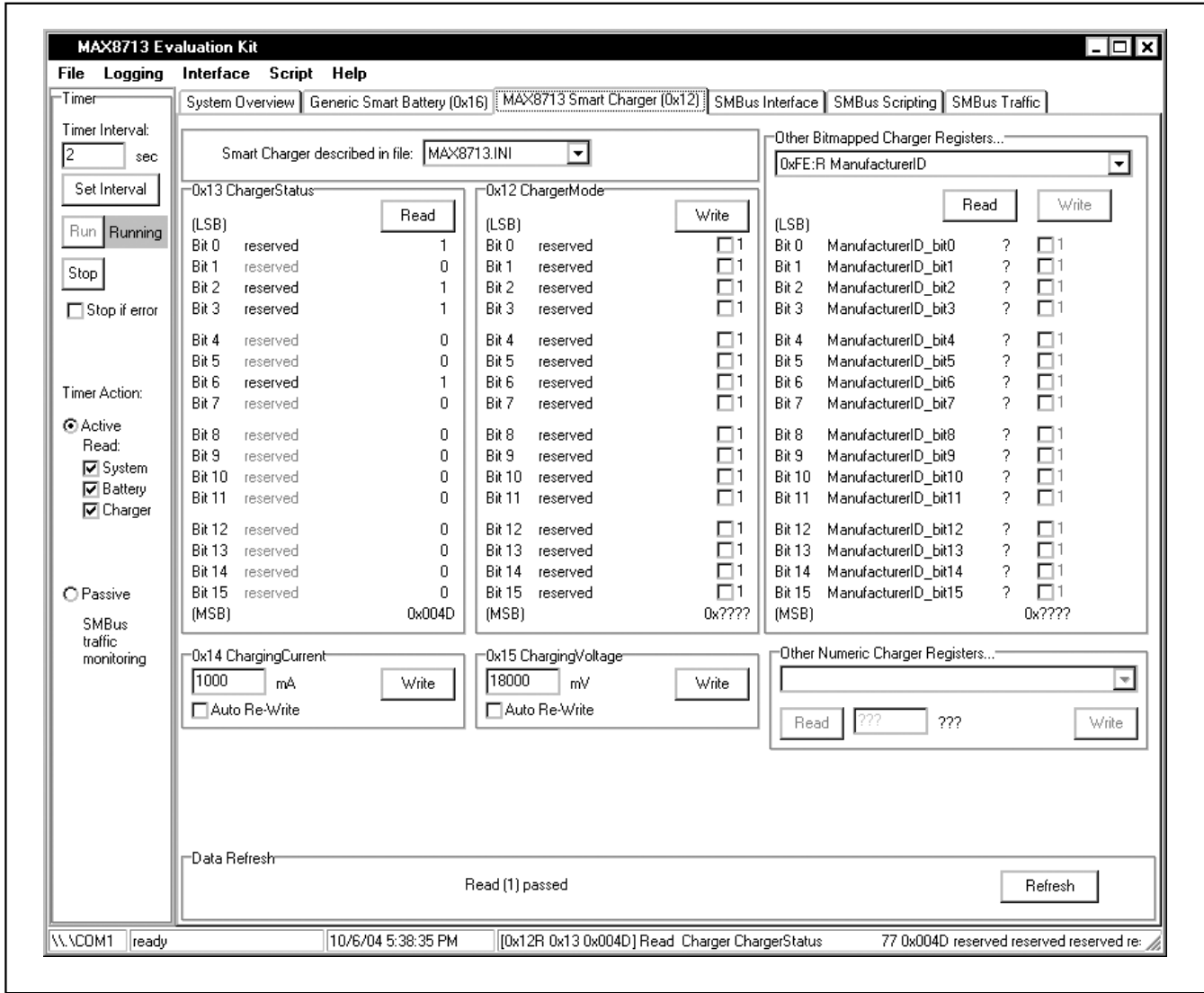

Figure 1. MAX8713 Smart-Charger Command Panel

# MAX8713 Evaluation Kit/Evaluation System

Evaluate: MAX8713

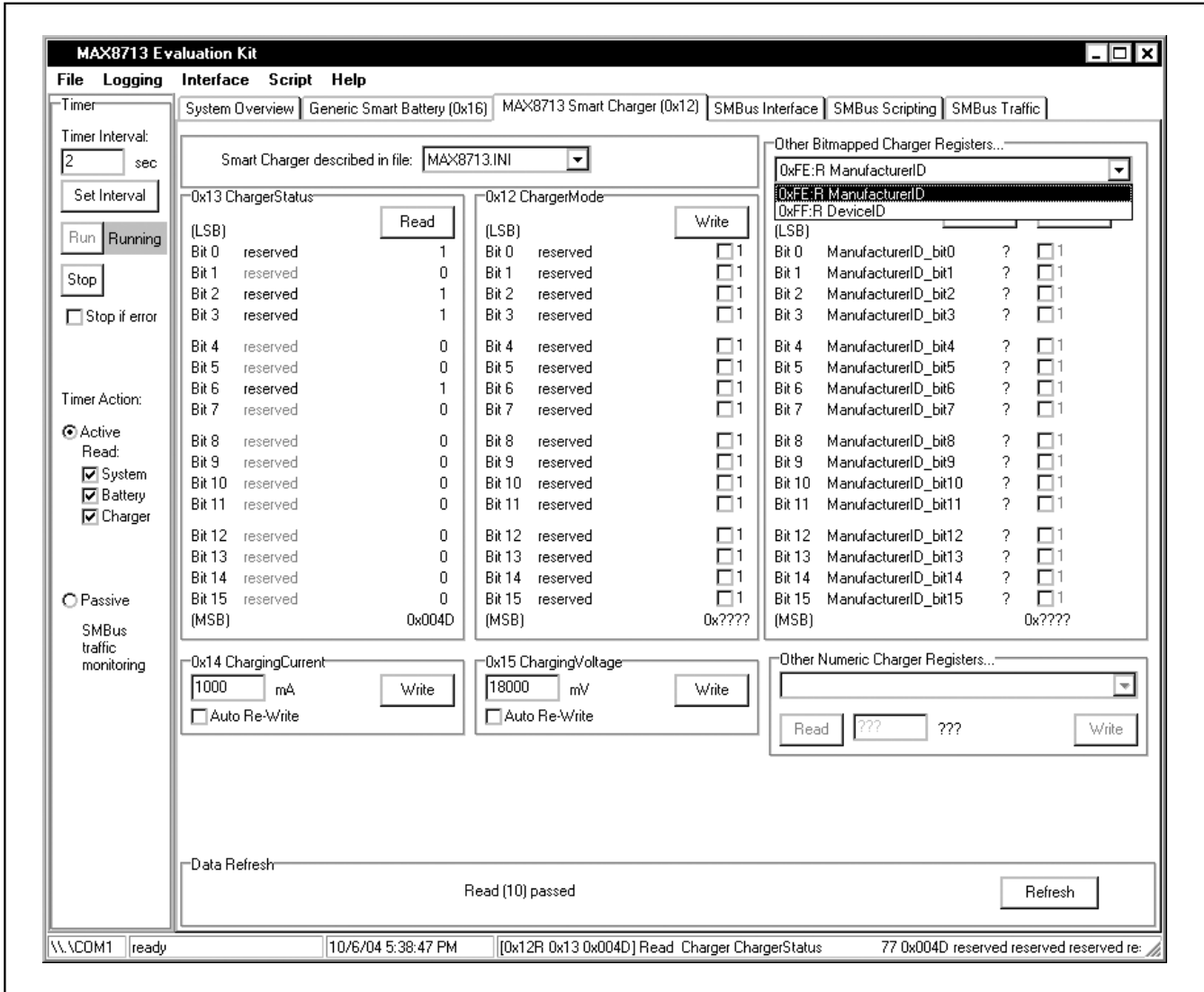

Figure 2. MAX8713 Smart-Charger Command Panel Showing the Pulldown List for Manufacturer ID and Device ID

# MAX8713 Evaluation Kit/Evaluation System

Evaluate: MAX8713

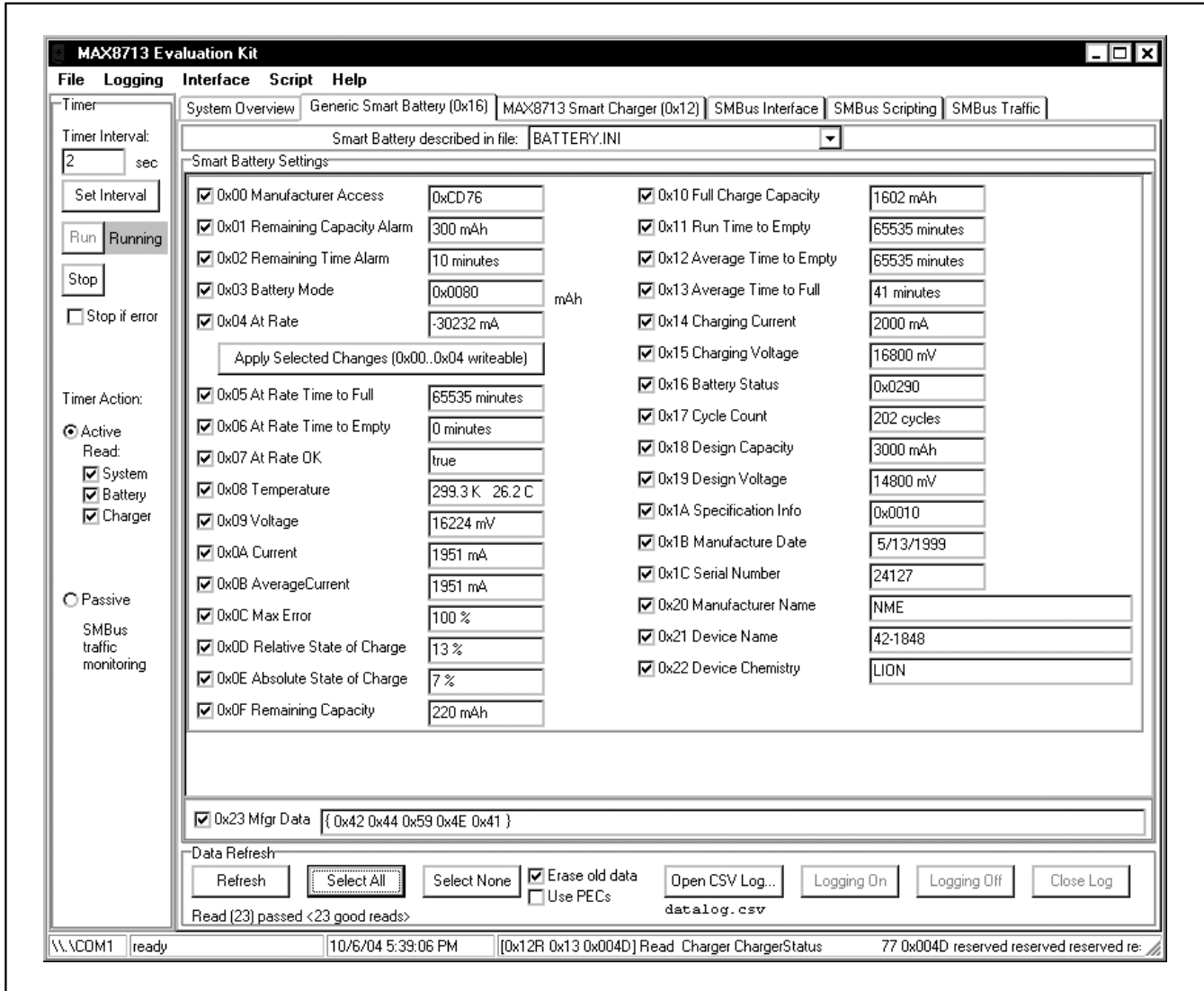

Figure 3. Smart-Battery Command Panel



# MAX8713 Evaluation Kit/Evaluation System

Evaluate: MAX8713

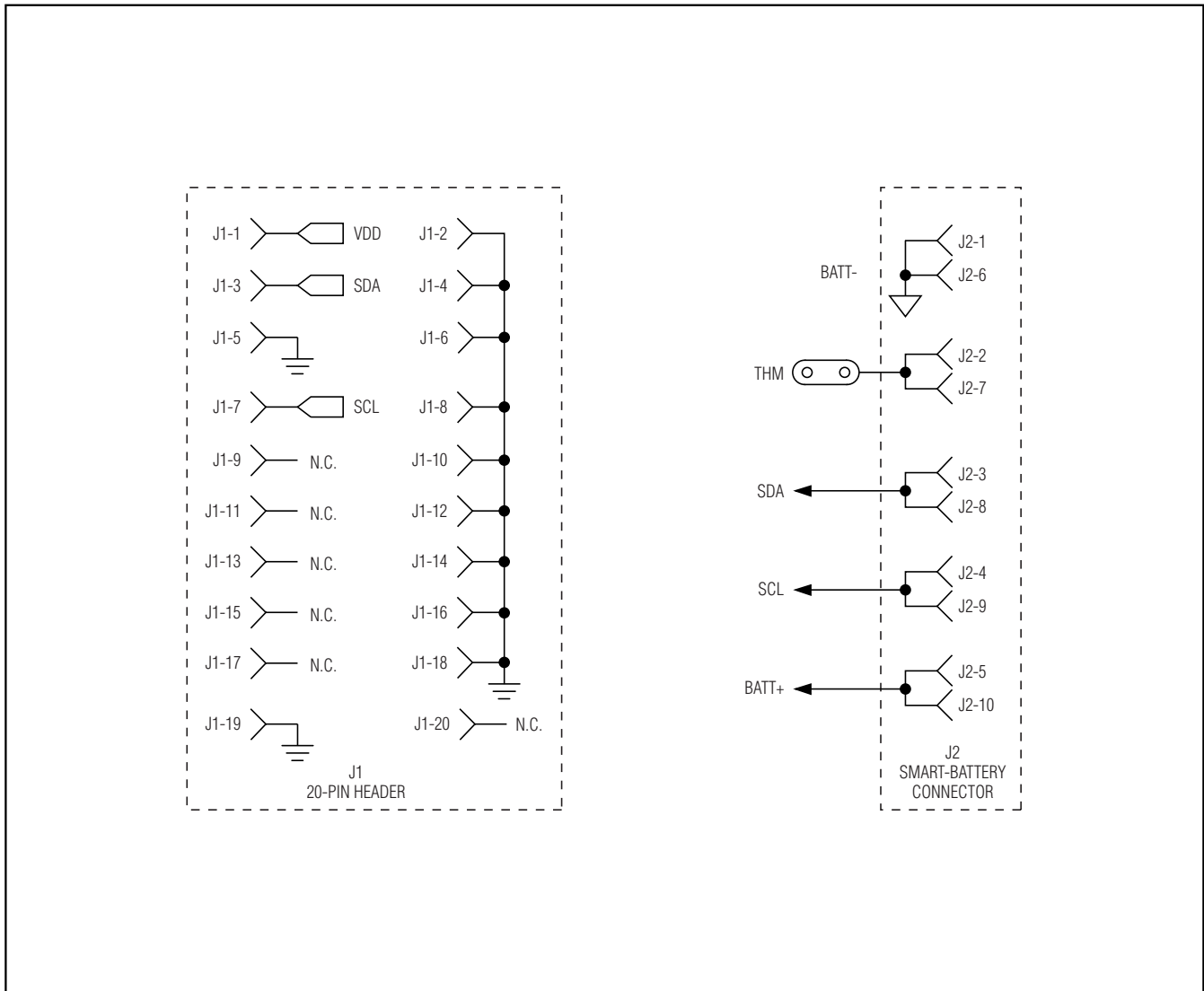

Figure 5. MAX8713 EV Kit Schematic—Smart-Battery Connector



# MAX8713 Evaluation Kit/Evaluation System

Evaluate: MAX8713

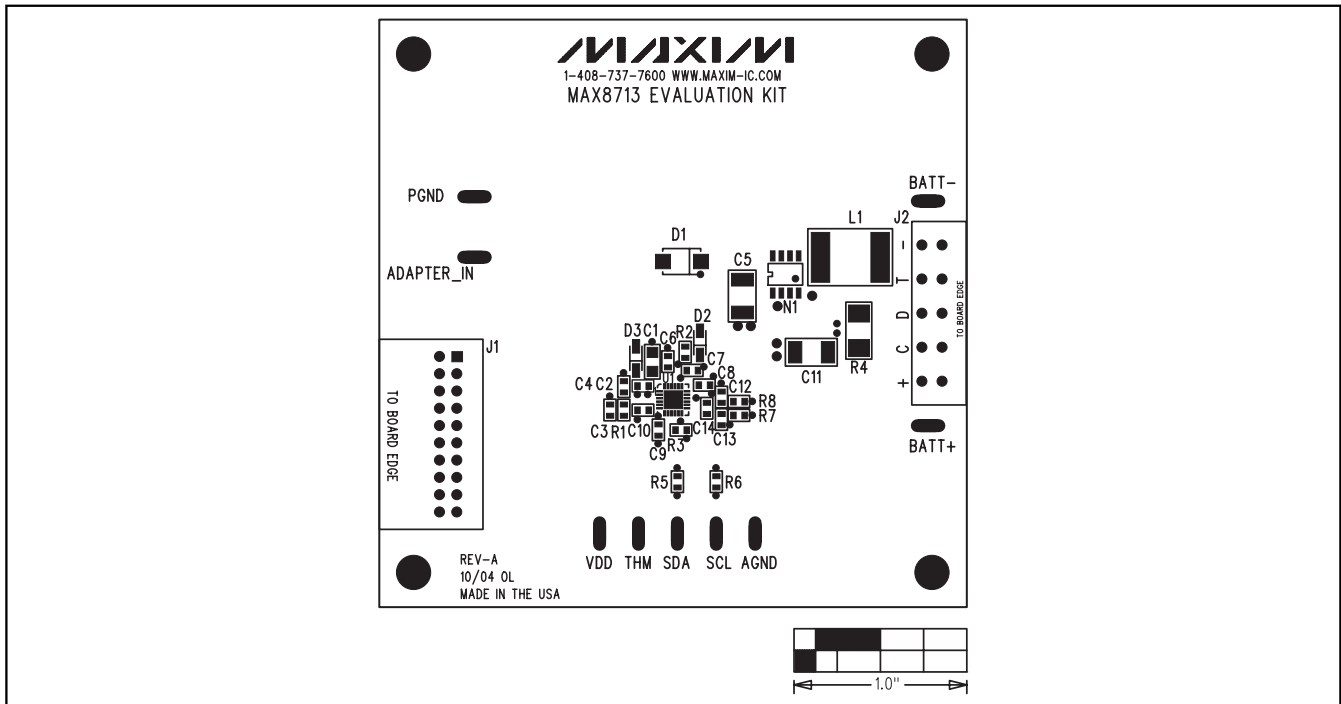

Figure 6. MAX8713 EV Kit Component Placement Guide—Component Side

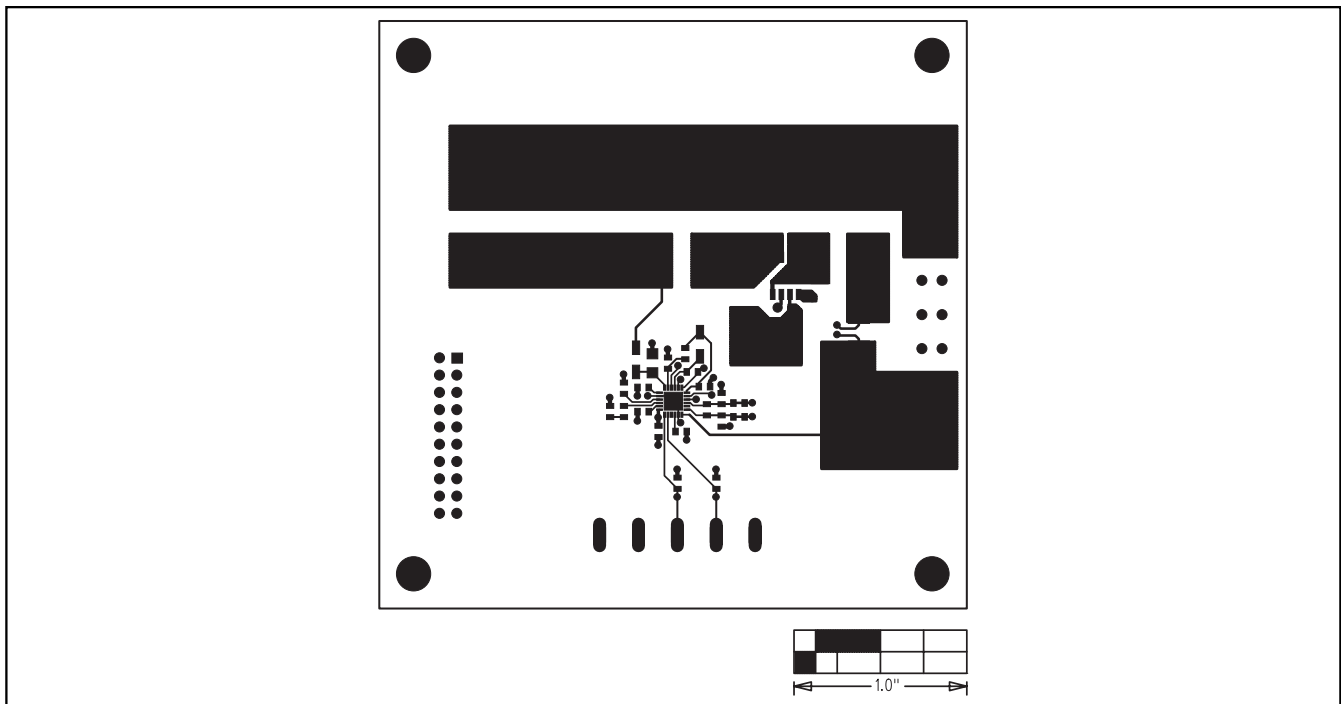

Figure 7. MAX8713 EV Kit PC Board Layout—Component Side

# MAX8713 Evaluation Kit/Evaluation System

Evaluate: MAX8713

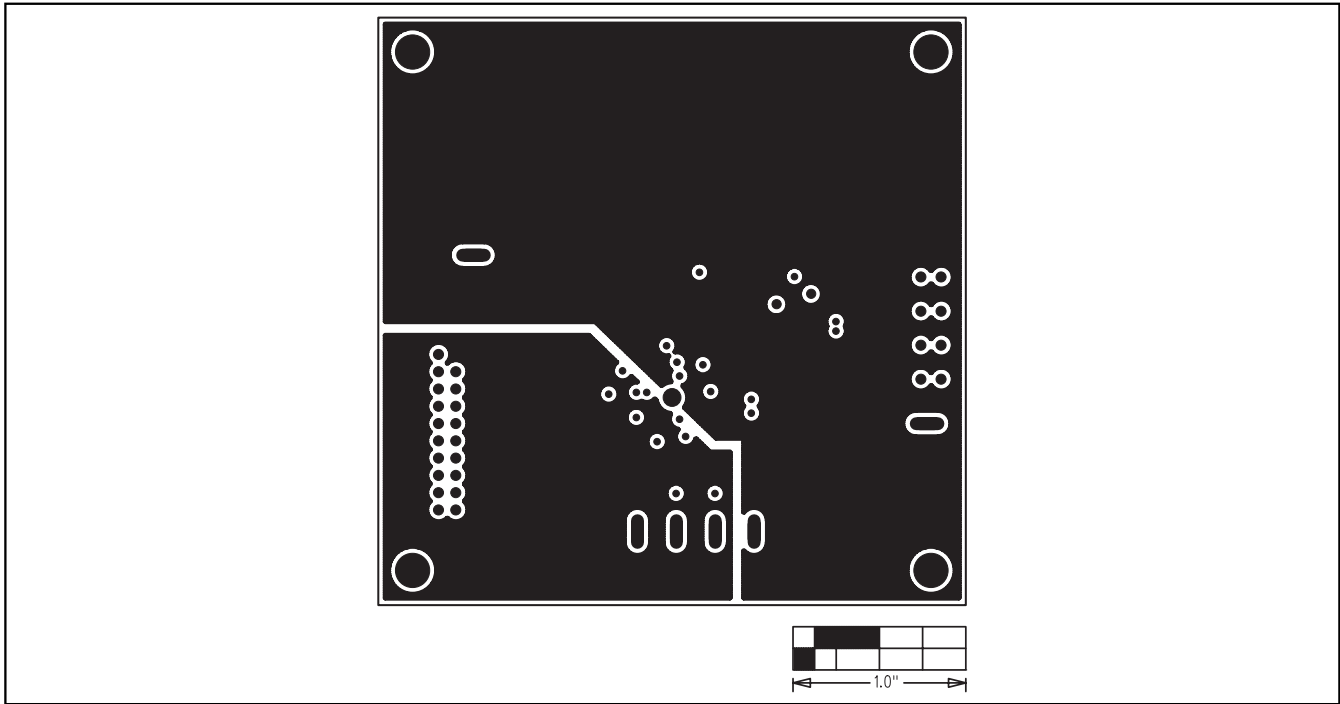

Figure 8. MAX8713 EV Kit PC Board Layout—VDD and Power Ground Plane

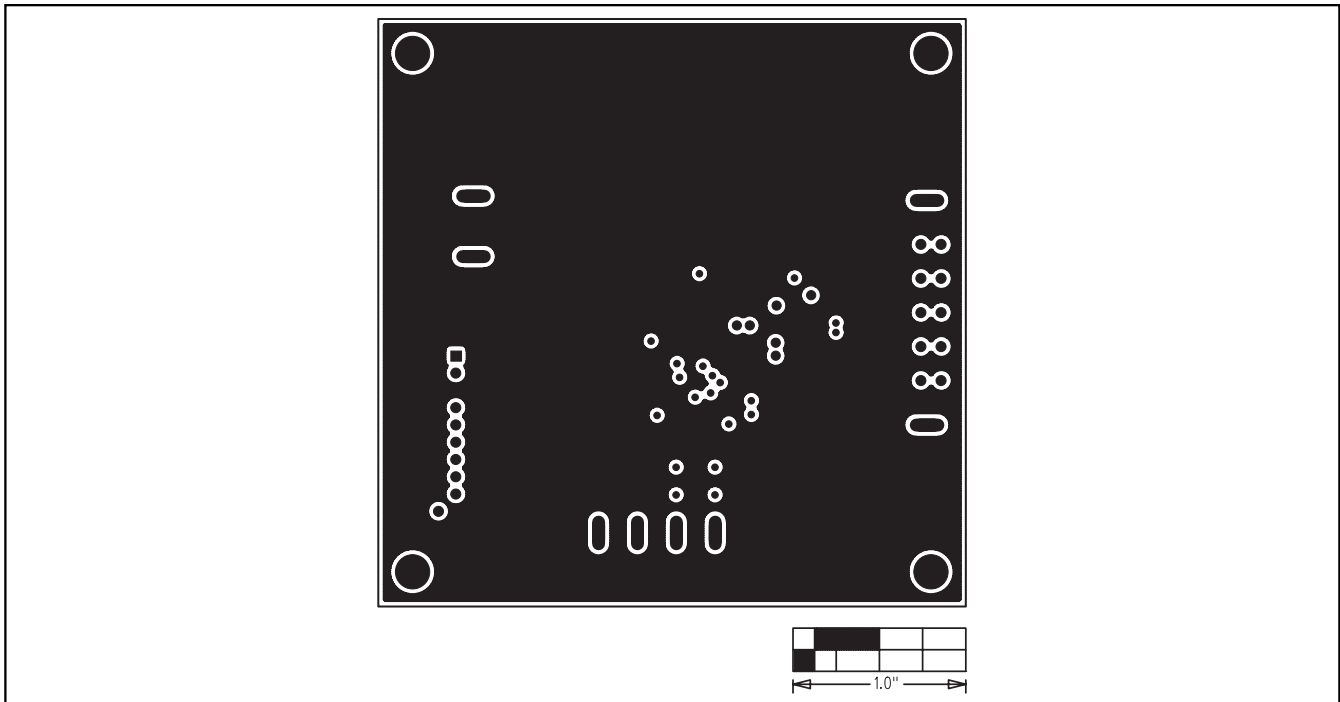

Figure 9. MAX8713 EV Kit PC Board Layout—Ground Plane