



# SC70, 5ns, Low-Power, Single-Supply, Precision TTL Comparators

## General Description

The MAX9010/MAX9011/MAX9013 single and MAX9012 dual, high-speed comparators operate from a single 4.5V to 5.5V power supply and feature low-current consumption. They have precision differential inputs and TTL outputs. They feature short propagation delay (5ns, typ), low-supply current, and a wide common-mode input range that includes ground. They are ideal for low-power, high-speed, single-supply applications.

The comparator outputs remain stable through the linear region when driven with slow-moving or low input-over-drive signals, eliminating the output instability common to other high-speed comparators. The input voltage range extends to 200mV below ground with no output phase reversal. The MAX9013 features complementary outputs and both the MAX9011/MAX9013 have a latch enable input (LE). The MAX9013 is an improved plug-in replacement for the industry-standard MAX913 and LT1016/LT1116, offering lower power and higher speed when used in a single 5V supply application.

For space-critical designs, the single MAX9010 is available in the tiny 6-pin SC70 package. The single MAX9011 is available in a space-saving 6-pin SOT23 package. The dual MAX9012 and the single MAX9013 are available in 8-pin  $\mu$ MAX and 8-pin SO packages. All products in the family are guaranteed over the extended temperature range of -40°C to +85°C.

## Applications

- High-Speed Signal Squaring
- Zero-Crossing Detectors
- High-Speed Line Receivers
- High-Speed Sampling Circuits
- High-Speed Triggers
- Fast Pulse-Width/Height Discriminators

## Features

- ◆ Ultra-Fast, 5ns Propagation Delay
- ◆ Low Quiescent Current:
  - 900 $\mu$ A (MAX9010/MAX9011)
  - 1.3mA (MAX9013)
  - 2.4mA (MAX9012)
- ◆ Single-Supply 4.5V to 5.5V Applications
- ◆ Input Range Extends Below Ground
- ◆ No Minimum Input Signal Slew-Rate Requirement
- ◆ No Supply-Current Spikes During Switching
- ◆ Stable when Driven with Slow-Moving Inputs
- ◆ No Output Phase Reversal for Overdriven Inputs
- ◆ TTL-Compatible Outputs (Complementary for MAX9013)
- ◆ Latch Function Included (MAX9011/MAX9013)
- ◆ High-Precision Comparators
  - 0.7mV Input Offset Voltage
  - 3.0V/mV Voltage Gain
- ◆ Available in Tiny 6-Pin SC70 and SOT23 Packages

## Ordering Information

PART	TEMP RANGE	PIN-PACKAGE	TOP MARK
MAX9010EXT-T	-40°C to +85°C	6 SC70-6	AAA
MAX9011EUT-T	-40°C to +85°C	6 SOT23-6	AADD
MAX9012EUA	-40°C to +85°C	8 $\mu$ MAX	—
MAX9012ESA	-40°C to +85°C	8 SO	—
MAX9013EUA	-40°C to +85°C	8 $\mu$ MAX	—
MAX9013ESA	-40°C to +85°C	8 SO	—

Selector Guide appears at end of data sheet.

## Pin Configurations

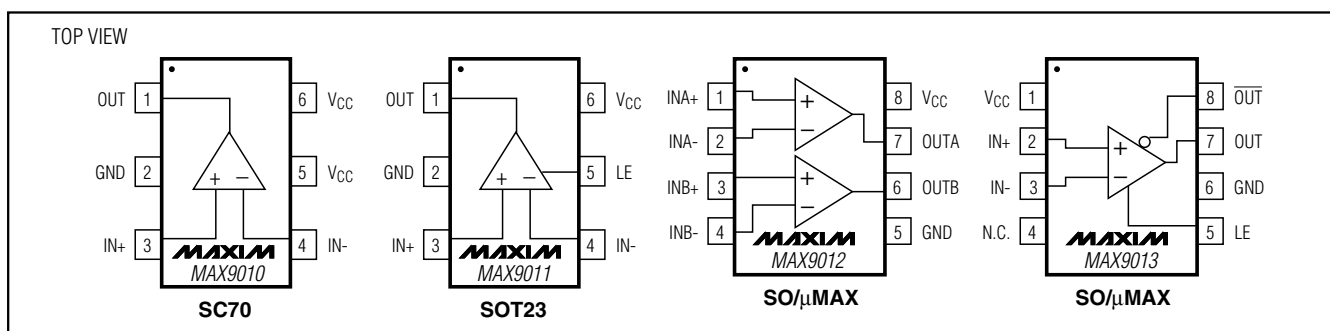

# SC70, 5ns, Low-Power, Single-Supply, Precision TTL Comparators

## ABSOLUTE MAXIMUM RATINGS

Power Supply ( $V_{CC}$ to GND) .....	-0.3V to +6V	8-Pin SO (derate 5.9mW/°C above +70°C).....	471mW
Analog Input (IN+ or IN-) to GND.....	-0.3V to ( $V_{CC} + 0.3V$ )	Operating Temperature Range .....	-40°C to +85°C
Input Current (IN+ or IN-) .....	$\pm 30mA$	Junction Temperature .....	+150°C
LE to GND .....	-0.3V to ( $V_{CC} + 0.3V$ )	Storage Temperature Range .....	-65°C to +150°C
Continuous Output Current.....	$\pm 40mA$	Lead Temperature (soldering, 10s) .....	+300°C
Continuous Power Dissipation ( $T_A = +70^\circ C$ )			
6-Pin SC70 (derate 3.1mW/°C above +70°C).....	245mW		
6-Pin SOT23 (derate 8.7mW/°C above +70°C).....	696mW		
8-Pin $\mu$ MAX (derate 4.5mW/°C above +70°C).....	362mW		

Stresses beyond those listed under "Absolute Maximum Ratings" may cause permanent damage to the device. These are stress ratings only, and functional operation of the device at these or any other conditions beyond those indicated in the operational sections of the specifications is not implied. Exposure to absolute maximum rating conditions for extended periods may affect device reliability.

## ELECTRICAL CHARACTERISTICS (MAX9010/MAX9011)

( $V_{CC} = 5V$ ,  $V_{LE} = 0$  (MAX9011 only),  $V_{CM} = 0$ ,  $T_A = T_{MIN}$  to  $T_{MAX}$ , unless otherwise noted. Typical values are at  $T_A = +25^\circ C$ .) (Note 1)

PARAMETER	SYMBOL	CONDITIONS	MIN	TYP	MAX	UNITS
Supply Voltage Range	$V_{CC}$	Inferred from $V_{OS}$ tests	4.5		5.5	V
Power-Supply Current (Note 2)	$I_{CC}$			0.90	2.1	mA
Input Offset Voltage (Note 3)	$V_{OS}$	$T_A = +25^\circ C$		$\pm 1$	$\pm 5$	mV
		$T_A = T_{MIN}$ to $T_{MAX}$			$\pm 7$	
Input Offset-Voltage Drift	$\Delta V_{OS}/\Delta T$			$\pm 2$		$\mu V/^\circ C$
Input Bias Current	$I_B$			$\pm 0.5$	$\pm 2$	$\mu A$
Input Offset Current	$I_{OS}$			$\pm 40$	$\pm 200$	nA
Differential Input Resistance (Note 4)	$R_{IN(DIFF)}$	$V_{IN(DIFF)} = \pm 10mV$		250		k $\Omega$
Common-Mode Input Resistance (Note 4)	$R_{IN(CM)}$	$-0.2V \leq V_{CM} \leq (V_{CC} - 1.9V)$		1		M $\Omega$
Common-Mode Input Voltage Range (Note 4)	$V_{CM}$	Inferred from $V_{OS}$ tests	-0.2	$V_{CC} - 1.9$		V
Common-Mode Rejection Ratio	CMRR	$-0.2V \leq V_{CM} \leq (V_{CC} - 1.9V)$		95		dB
Power-Supply Rejection Ratio	PSRR	$V_{CC} = 4.5V$ to $5.5V$		82		dB
Small-Signal Voltage Gain	$A_V$	$1V \leq V_{OUT} \leq 2V$		3000		V/V
Output Low Voltage	$V_{OL}$	$V_{IN} \geq 100mV$	$I_{SINK} = 0$	0.3	0.5	V
			$I_{SINK} = 4mA$	0.5	0.6	
Output High Voltage	$V_{OH}$	$V_{IN} \geq 100mV$ , $V_{CC} = 4.5V$	$I_{SOURCE} = 0$	2.7	3.3	V
			$I_{SOURCE} = 4mA$	2.4	2.9	
Output Short-Circuit Current	$I_{OUT}$	Sinking		20		mA
		Sourcing		30		
Latch Enable Pin High Input Voltage	$V_{IH}$	MAX9011 only	2			V
Latch Enable Pin Low Input Voltage	$V_{IL}$	MAX9011 only			0.8	V
Latch Enable Pin Bias Current	$I_{IH}$ , $I_{IL}$	MAX9011 only, $V_{LE} = 0$ and $V_{LE} = 5V$			$\pm 25$	$\mu A$

# SC70, 5ns, Low-Power, Single-Supply, Precision TTL Comparators

MAX9010-MAX9013

## ELECTRICAL CHARACTERISTICS (MAX9010/MAX9011) (continued)

( $V_{CC} = 5V$ ,  $V_{LE} = 0$  (MAX9011 only),  $V_{CM} = 0$ ,  $T_A = T_{MIN}$  to  $T_{MAX}$ , unless otherwise noted. Typical values are at  $T_A = +25^\circ C$ .) (Note 1)

PARAMETER	SYMBOL	CONDITIONS	MIN	TYP	MAX	UNITS
Latch Setup Time (Note 8)	$t_{SU}$	MAX9011 only	2	0		ns
Latch Hold Time (Note 8)	$t_H$	MAX9011 only	2	0.5		ns
Latch Propagation Delay (Note 8)	$t_{LPD}$	MAX9011 only		5		ns
Input Noise-Voltage Density	$e_n$	$f = 100kHz$		6		$nV/\sqrt{Hz}$
Propagation Delay (Note 6)	$t_{PD+}$ , $t_{PD-}$	$C_{LOAD} = 5pF$ , $T_A = +25^\circ C$	$V_{OVERDRIVE} = 100mV$	5	8	ns
			$V_{OVERDRIVE} = 5mV$	5.5	9	
		$C_{LOAD} = 5pF$ , $T_A = T_{MIN}$ to $T_{MAX}$	$V_{OVERDRIVE} = 100mV$		9	
			$V_{OVERDRIVE} = 5mV$		10	
Output Rise Time	$t_R$	$0.5V \leq V_{OUT} \leq 2.5V$		3		ns
Output Fall Time	$t_F$	$2.5V \geq V_{OUT} \geq 0.5V$		2		ns
Input Capacitance	$C_{IN}$	MAX9010EXT		0.8		pF
		MAX9011EUT		1.2		
Power-Up Time	$t_{ON}$			1		$\mu s$

## ELECTRICAL CHARACTERISTICS (MAX9012/MAX9013)

( $V_{CC} = 5V$ ,  $V_{LE} = 0$  (MAX9013 only),  $V_{CM} = 0$ ,  $T_A = T_{MIN}$  to  $T_{MAX}$ , unless otherwise noted. Typical values are at  $T_A = +25^\circ C$ .) (Note 1)

PARAMETER	SYMBOL	CONDITIONS	MIN	TYP	MAX	UNITS
Supply Voltage Range	$V_{CC}$	Inferred from PSRR test	4.5		5.5	V
Power-Supply Current (Note 2)	$I_{CC}$	MAX9012		2.4	4.2	mA
		MAX9013		1.3	2.3	
Input Offset Voltage (Note 5)	$V_{OS}$	$T_A = +25^\circ C$		$\pm 0.7$	$\pm 3$	mV
		$T_A = T_{MIN}$ to $T_{MAX}$			$\pm 5.5$	
Input Offset-Voltage Drift	$\Delta V_{OS}/\Delta T$			$\pm 2$		$\mu V/^\circ C$
Input Bias Current	$I_B$			$\pm 0.5$	$\pm 2$	$\mu A$
Input Offset Current	$I_{OS}$			$\pm 40$	$\pm 200$	nA
Differential Input Resistance (Note 4)	$R_{IN(DIFF)}$	$V_{IN(DIFF)} = \pm 10mV$		250		$k\Omega$
Common-Mode Input Resistance (Note 4)	$R_{IN(CM)}$	$-0.2V \leq V_{CM} \leq (V_{CC} - 1.9V)$		1		$M\Omega$
Common-Mode Input Voltage Range (Note 4)	$V_{CM}$	Inferred from CMRR test	-0.2	$V_{CC} - 1.9$		V
Common-Mode Rejection Ratio	CMRR	$-0.2V \leq V_{CM} \leq (V_{CC} - 1.9V)$	75	95		dB
Power-Supply Rejection Ratio	PSRR	$V_{CC} = 4.5V$ to $5.5V$	63	82		dB

# SC70, 5ns, Low-Power, Single-Supply, Precision TTL Comparators

## ELECTRICAL CHARACTERISTICS (MAX9012/MAX9013) (continued)

( $V_{CC} = 5V$ ,  $V_{LE} = 0$  (MAX9013 only),  $V_{CM} = 0$ ,  $T_A = T_{MIN}$  to  $T_{MAX}$ , unless otherwise noted. Typical values are at  $T_A = +25^\circ C$ .) (Note 1)

PARAMETER	SYMBOL	CONDITIONS		MIN	TYP	MAX	UNITS	
Small-Signal Voltage Gain	$A_V$	$1V \leq V_{OUT} \leq 2V$		1000	3000		V/V	
Output Low Voltage	$V_{OL}$	$V_{IN} \geq 100mV$	$I_{SINK} = 0$		0.3	0.5	V	
			$I_{SINK} = 4mA$		0.5	0.6		
Output High Voltage	$V_{OH}$	$V_{IN} \geq 100mV$ , $V_{CC} = 4.5V$	$I_{SOURCE} = 0$		2.7	3.3	V	
			$I_{SOURCE} = 4mA$		2.4	2.9		
Output Short-Circuit Current	$I_{OUT}$	Sinking			20		mA	
		Sourcing			30			
Latch Enable Pin High Input Voltage	$V_{IH}$	MAX9013 only		2			V	
Latch Enable Pin Low Input Voltage	$V_{IL}$	MAX9013 only				0.8	V	
Latch Enable Pin Bias Current	$I_{IH}$ , $I_{IL}$	MAX9013 only $V_{LE} = 0$ and $V_{LE} = 5V$				$\pm 25$	$\mu A$	
Input Noise-Voltage Density	$e_n$	$f = 100kHz$			6		$nV/\sqrt{Hz}$	
Propagation Delay (Note 6)	$t_{PD+}$ , $t_{PD-}$	$C_{LOAD} = 5pF$ , $T_A = +25^\circ C$	$V_{OVERDRIVE} = 100mV$		5	8	ns	
			$V_{OVERDRIVE} = 5mV$		5.5	9		
		$C_{LOAD} = 5pF$ , $T_A = T_{MIN}$ to $T_{MAX}$	$V_{OVERDRIVE} = 100mV$					9
			$V_{OVERDRIVE} = 5mV$					10
Differential Propagation Delay (Notes 6, 7)	$\Delta t_{PD\pm}$	$V_{IN} = 100mV$ step, $C_{LOAD} = 5pF$ , $V_{OD} = 5mV$			2	3	ns	
Channel-to-Channel Propagation Delay (Note 6)	$\Delta t_{PD(ch-ch)}$	MAX9012 only, $V_{IN} = 100mV$ step, $C_{LOAD} = 5pF$ , $V_{OD} = 5mV$			500		ps	
Output Rise Time	$t_R$	$0.5V \leq V_{OUT} \leq 2.5V$			3		ns	
Output Fall Time	$t_F$	$2.5V \geq V_{OUT} \geq 0.5V$			2		ns	
Latch Setup Time (Note 8)	$t_{SU}$	MAX9013 only		2	0		ns	
Latch Hold Time (Note 8)	$t_H$	MAX9013 only		2	0.5		ns	
Latch Propagation Delay (Note 8)	$t_{LPD}$	MAX9013 only			5		ns	
Input Capacitance	$C_{IN}$	MAX9012EUA/MAX9013EUA			1.5		pF	
		MAX9012ESA/MAX9013ESA			2			
Power-Up Time	$t_{ON}$				1		$\mu s$	

**Note 1:** All specifications are 100% tested at  $T_A = +25^\circ C$ ; temperature limits are guaranteed by design.

**Note 2:** Quiescent Power-Supply Current is slightly higher with the comparator output at  $V_{OL}$ . This parameter is specified with the worst-case condition of  $V_{OUT} = V_{OL}$  for the MAX9010/MAX9011 and both outputs at  $V_{OL}$  for the MAX9012. For the MAX9013, which has complementary outputs, the power-supply current is specified with either  $OUT = V_{OL}$ ,  $OUT = V_{OH}$  or  $OUT = V_{OH}$ ,  $OUT = V_{OL}$  (power-supply current is equal in either case).

**Note 3:** Input Offset Voltage is tested and specified with the Input Common-Mode Voltage set to either extreme of the Input Common-Mode Voltage Range ( $-0.2V$  to  $(V_{CC} - 1.9V)$ ) and with the Power-Supply Voltage set to either extreme of the Power-Supply Voltage Range ( $4.5V$  to  $5.5V$ ).

# SC70, 5ns, Low-Power, Single-Supply, Precision TTL Comparators

MAX9010-MAX9013

- Note 4:** Although Common-Mode Input Voltage Range is restricted to  $-0.2V \leq V_{CM} \leq (V_{CC} - 1.9V)$ , either or both inputs can go to either absolute maximum voltage limit, i.e., from  $-0.3V$  to  $(V_{CC} + 0.3V)$ , without damage. The comparator will make a correct (and fast) logic decision provided that at least one of the two inputs is within the specified common-mode range. If both inputs are outside the common-mode range, the comparator output state is indeterminate.
- Note 5:** For the MAX9012, Input Offset Voltage is defined as the input voltage(s) required to make the OUT output voltage(s) remain stable at 1.4V. For the MAX9013, it is defined as the average of two input offset voltages, measured by forcing first the OUT output, then the  $\overline{OUT}$  output to 1.4V.
- Note 6:** Propagation delay for these high-speed comparators is guaranteed by design because it cannot be accurately measured with low levels of input overdrive voltage using automatic test equipment in production. Note that for low overdrive conditions,  $V_{OS}$  is added to the overdrive.
- Note 7:** Differential Propagation Delay, measured either on a single output of the MAX9012/MAX9013 (or between OUT and  $\overline{OUT}$  outputs on the MAX9013) is defined as:  $\Delta t_{PD(\pm)} = |t_{PD(+)} - t_{PD(-)}|$ .
- Note 8:** Latch times are guaranteed by design. Latch setup time ( $t_{SU}$ ) is the interval in which the input signal must be stable prior to asserting the latch signal. The hold time ( $t_H$ ) is the interval after the latch is asserted in which the input signal must remain stable. Latch propagation delay ( $t_{LPD}$ ) is the delay time for the output to respond when the latch enable pin is deasserted (see Figure 1).

## Typical Operating Characteristics

( $V_{CC} = 5V$ ,  $C_L = 15pF$ ,  $T_A = +25^\circ C$ , unless otherwise noted.)

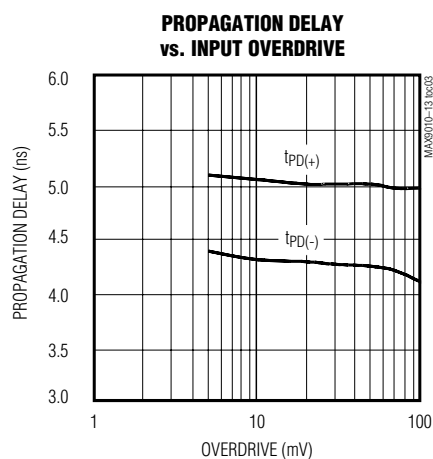
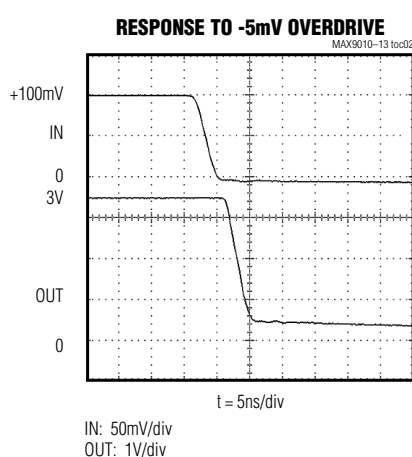
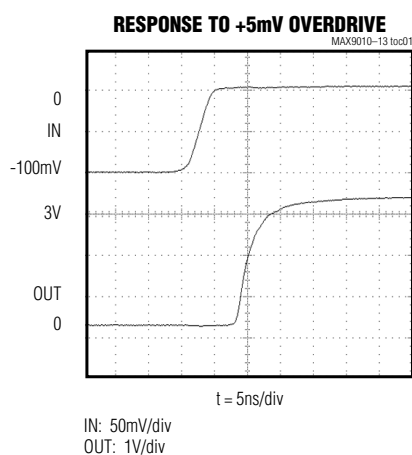

# SC70, 5ns, Low-Power, Single-Supply, Precision TTL Comparators

## Typical Operating Characteristics (continued)

( $V_{CC} = 5V$ ,  $C_L = 15pF$ ,  $T_A = +25^\circ C$ , unless otherwise noted.)

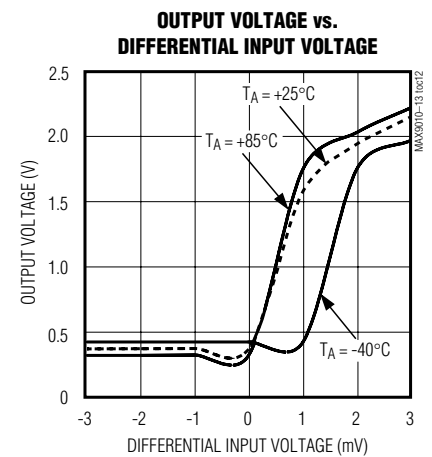
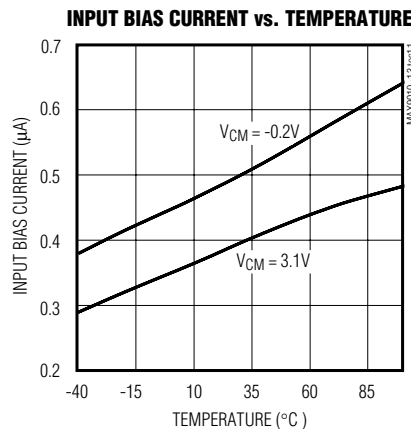
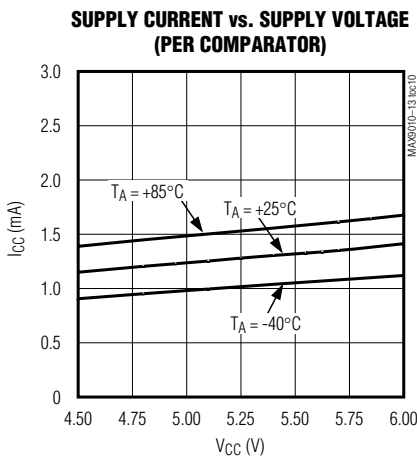
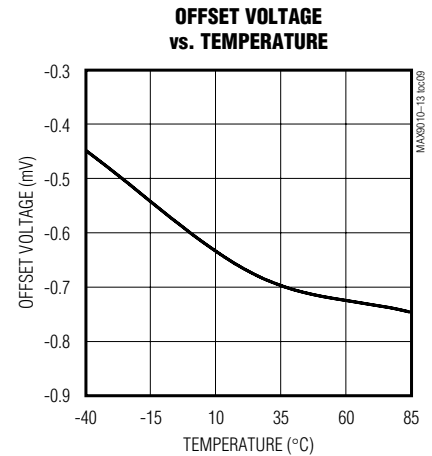
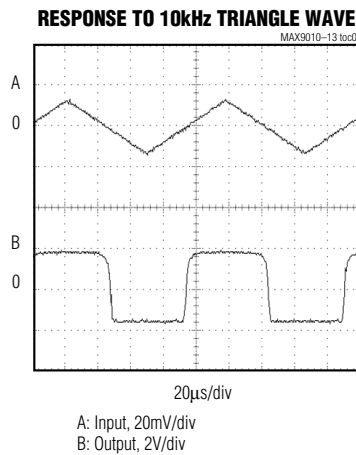
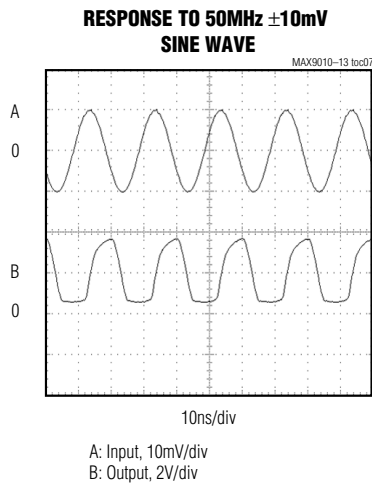
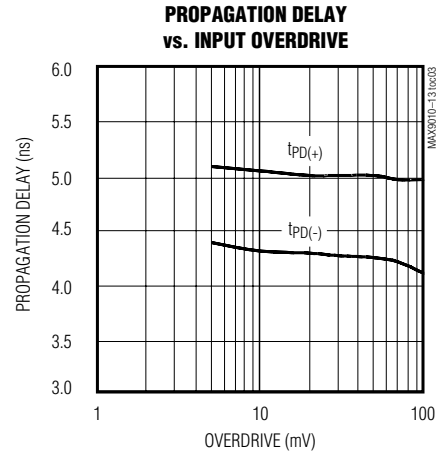
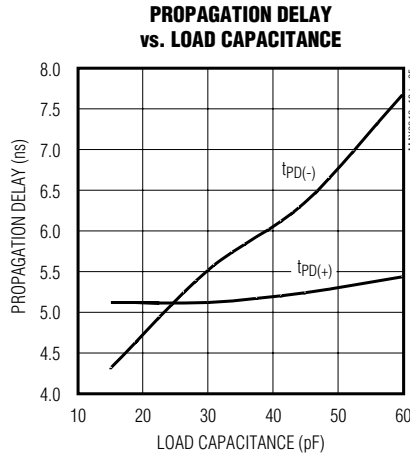
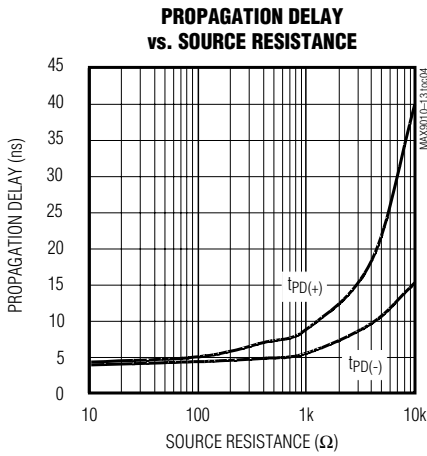

# SC70, 5ns, Low-Power, Single-Supply, Precision TTL Comparators

## Pin Description

MAX9010-MAX9013

PIN				NAME	FUNCTION
MAX9010	MAX9011	MAX9012	MAX9013		
1	1	—	7	OUT	Comparator Output. OUT is high when IN+ is more positive than IN-.
2	2	5	6	GND	Ground
3	3	—	2	IN+	Noninverting Input
4	4	—	3	IN-	Inverting Input
5, 6	6	8	1	V <sub>CC</sub>	Positive Power-Supply Voltage. Pins 5 and 6 of the MAX9010 must BOTH be connected to the power-supply rail. Bypass with a 0.1μF capacitor.
—	5	—	5	LE	Latch Enable Input
—	—	1	—	INA+	Noninverting Input, Channel A
—	—	2	—	INA-	Inverting Input, Channel A
—	—	3	—	INB+	Noninverting Input, Channel B
—	—	4	—	INB-	Inverting Input, Channel B
—	—	6	—	OUTB	Comparator Output, Channel B
—	—	7	—	OUTA	Comparator Output, Channel A
—	—	—	4	N.C.	No Connection. Not internally connected. Connect to GND for best results.
—	—	—	8	$\overline{\text{OUT}}$	Comparator Complementary Output

### Detailed Description

These high-speed comparators have a unique design that prevents oscillation when the comparator is in its linear region, so no minimum input slew rate is required. Many high-speed comparators oscillate in their linear region. One common way to overcome this oscillation is to add hysteresis, but it results in a loss of resolution and bandwidth.

#### Latch Function

The MAX9011/MAX9013 provide a TTL-compatible latch function that holds the comparator output state (Figure 1). With LE driven to a TTL low or grounded, the latch is transparent and the output state is determined by the input differential voltage. When LE is driven to a TTL high, the existing output state is latched, and the input differential voltage has no further effect on the output state.

#### Input Amplifier

A comparator can be thought of as having two sections: an input amplifier and a logic interface. The input amplifiers of these devices are fully differential, with input offset voltages typically 0.7mV at +25°C. Input common-mode range extends from 200mV below ground to 1.9V below the positive power-supply rail. The

total common-mode range is 3.3V when operating from a 5V supply. The amplifiers have no built-in hysteresis. For highest accuracy, do not add hysteresis. Figure 2 shows how hysteresis degrades resolution.

#### Input Voltage Range

Although the common-mode input voltage range is restricted to -0.2V to (V<sub>CC</sub> - 1.9V), either or both inputs can go to either absolute maximum voltage limit, i.e., from -0.3V to (V<sub>CC</sub> + 0.3V), without damage. The comparator will make a correct (and fast) logic decision provided that at least one of the two inputs is within the specified common-mode range. If both inputs are outside the common-mode range, the comparator output state is indeterminate.

#### Resolution

A comparator's ability to resolve a small-signal difference, its resolution, is affected by various factors. As with most amplifiers and comparators, the most significant factors are the input offset voltage (V<sub>OS</sub>) and the common-mode and power-supply rejection ratios (CMRR, PSRR). If source impedance is high, input offset current can be significant. If source impedance is unbalanced, the input bias current can introduce another error. For high-speed comparators, an addi-

# SC70, 5ns, Low-Power, Single-Supply, Precision TTL Comparators

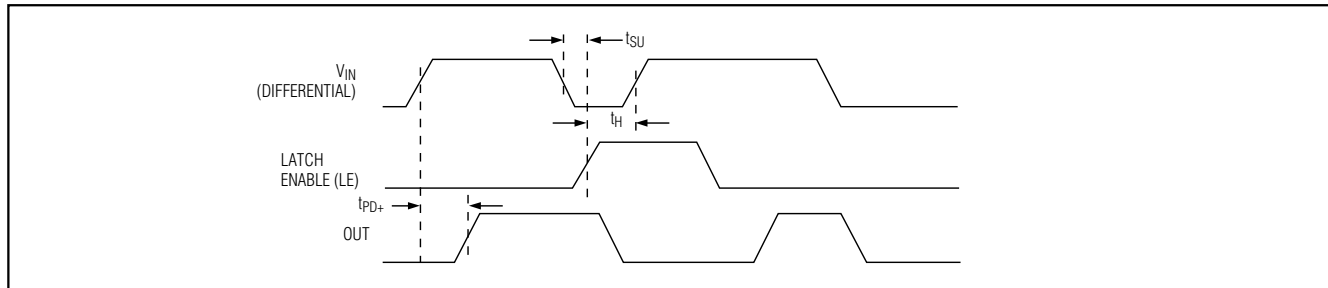

Figure 1. Timing Diagram

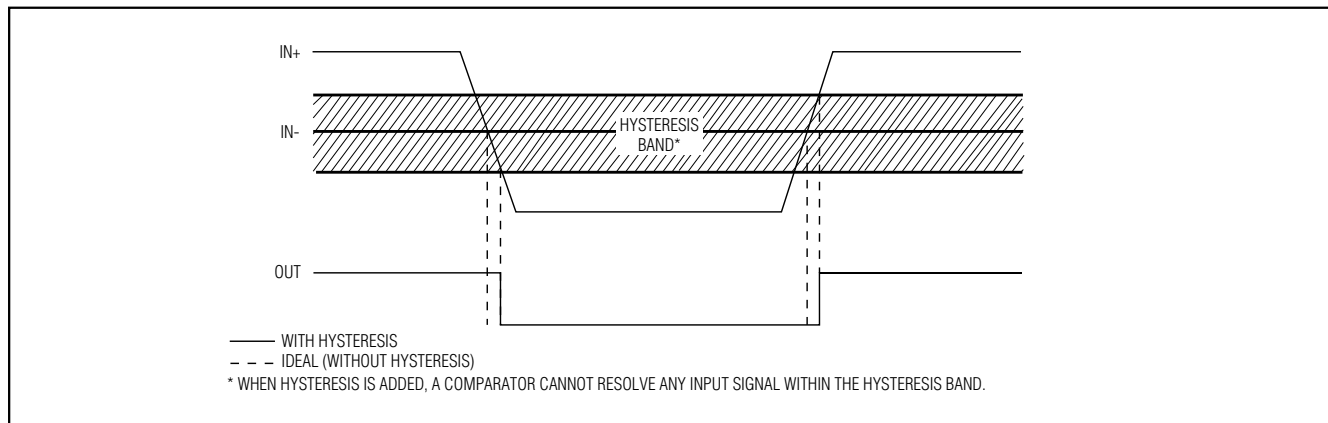

Figure 2. Effect of Hysteresis on Input Resolution

tional factor in resolution is the comparator's stability in its linear region. Many high-speed comparators are useless in their linear region because they oscillate. This makes the differential input voltage region around zero unusable. Hysteresis helps to cure the problem but reduces resolution (Figure 2). The devices do not oscillate in the linear region and require no hysteresis, which greatly enhances their resolution.

## Applications Information

### Power Supplies, Bypassing, and Board Layout

These products operate over a supply voltage range of 4.5V to 5.5V. Bypass  $V_{CC}$  to GND with a 0.1 $\mu$ F surface-mount ceramic capacitor. Mount the ceramic capacitor as close as possible to the supply pin to minimize lead inductance.

As with all high-speed components, careful attention to board layout is essential for best performance. Use a PC board with an unbroken ground plane. Pay close attention to the bandwidth of bypass components and place them as close as possible to the device.

Minimize the trace length and area at the comparator inputs. If the source impedance is high, take the utmost care in minimizing its susceptibility to pickup of unwanted signals.

### Input Slew Rate

Most high-speed comparators have a minimum input slew-rate requirement. If the input signal does not transverse the region of instability within a propagation delay of the comparator, the output can oscillate. This makes many high-speed comparators unsuitable for processing either slow-moving signals or fast-moving signals with low overdrive. The design of these devices eliminates the minimum input slew-rate requirement. They are excellent for circuits from DC up to 200MHz, even with very low overdrive, where small signals need to be resolved.



# SC70, 5ns, Low-Power, Single-Supply, Precision TTL Comparators

**MAX9010-MAX9013**

## Selector Guide

PART	COMPARATORS	LATCH	COMPLEMENTARY OUTPUTS
MAX9010	1	No	No
MAX9011	1	Yes	No
MAX9012	2	No	No
MAX9013	1	Yes	Yes

## Chip Information

MAX9010 TRANSISTOR COUNT: 106  
 MAX9011 TRANSISTOR COUNT: 137  
 MAX9012 TRANSISTOR COUNT: 212  
 MAX9013 TRANSISTOR COUNT: 145  
 PROCESS: Bipolar

## Package Information

PIN 1 DOT (SEE NOTE 6)

PIN 1

Q1

SYMBOL	MIN	MAX
e	0.65	BSC
D	1.80	2.20
b	0.15	0.30
E	1.15	1.35
HE	1.80	2.40
Q1	0.10	0.40
A2	0.80	1.00
A1	0.00	0.10
A	0.80	1.10
c	0.10	0.18
L	0.10	0.30
L1	0.425	TYP.

- ALL DIMENSIONS ARE IN MILLIMETERS
- DIMENSIONS ARE INCLUSIVE OF PLATING
- DIMENSIONS ARE EXCLUSIVE OF MOLD FLASH & METAL BURR
- ALL SPECIFICATIONS COMPLY TO EIAJ SC70
- COPLANARITY 4 MILS. MAX.
- PIN 1 I.D. DOT

**MAXIM**  
 PROPRIETARY INFORMATION  
 TITLE:  
 PACKAGE OUTLINE, SC70, 6L  
 APPROVAL: \_\_\_\_\_ DOCUMENT CONTROL NO. 21-0077 REV B 1/1

SC70, 6LEPS

# SC70, 5ns, Low-Power, Single-Supply, Precision TTL Comparators

## Package Information (continued)

SEE NOTE 5  
EXAMPLE  
TOP MARK

PIN 1  
I.D. DOT  
(SEE NOTE 6)

PIN #1

0.20

DATUM "A"

SYMBOL	MIN	MAX
A	0.90	1.45
A1	0.00	0.15
A2	0.90	1.30
b	0.35	0.50
C	0.08	0.20
D	2.80	3.00
E	2.60	3.00
E1	1.50	1.75
L	0.35	0.55
e	0.95 REF	
$\alpha$	0°	10°

NOTES:

- ALL DIMENSIONS ARE IN MILLIMETERS.
- FOOT LENGTH MEASURED AT INTERCEPT POINT BETWEEN DATUM A & LEAD SURFACE.
- PACKAGE OUTLINE EXCLUSIVE OF MOLD FLASH & METAL BURR.
- PACKAGE OUTLINE INCLUSIVE OF SOLDER PLATING.
- PIN 1 IS LOWER LEFT PIN WHEN READING TOP MARK FROM LEFT TO RIGHT. (SEE EXAMPLE TOP MARK)
- PIN 1 I.D. DOT IS 0.3 MM  $\phi$  MIN. LOCATED ABOVE PIN 1.
- MEETS JEDEC MO178.

6LSOTEPS

<b>MAXIM</b>		
PROPRIETARY INFORMATION		
TITLE: PACKAGE OUTLINE, SOT-23, 6L		
APPROVAL	DOCUMENT CONTROL NO. 21-0058	REV E 1/1

# SC70, 5ns, Low-Power, Single-Supply, Precision TTL Comparators

## Package Information (continued)

MAX9010-MAX9013

8LUMAXD.EPS

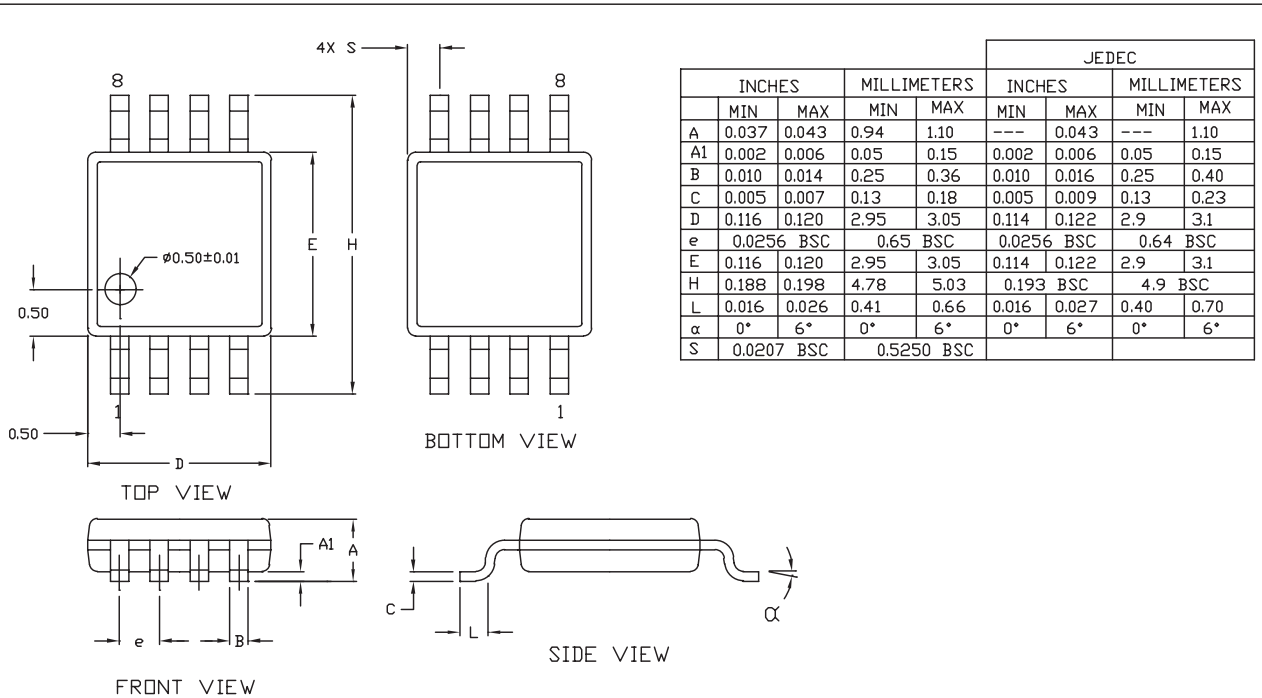

	INCHES		MILLIMETERS		JEDEC			
	MIN	MAX	MIN	MAX	MIN	MAX	MIN	MAX
A	0.037	0.043	0.94	1.10	---	0.043	---	1.10
A1	0.002	0.006	0.05	0.15	0.002	0.006	0.05	0.15
B	0.010	0.014	0.25	0.36	0.010	0.016	0.25	0.40
C	0.005	0.007	0.13	0.18	0.005	0.009	0.13	0.23
D	0.116	0.120	2.95	3.05	0.114	0.122	2.9	3.1
e	0.0256	BSC	0.65	BSC	0.0256	BSC	0.64	BSC
E	0.116	0.120	2.95	3.05	0.114	0.122	2.9	3.1
H	0.188	0.198	4.78	5.03	0.193	BSC	4.9	BSC
L	0.016	0.026	0.41	0.66	0.016	0.027	0.40	0.70
alpha	0°	6°	0°	6°	0°	6°	0°	6°
S	0.0207	BSC	0.5250	BSC				

- NOTES:
1. D&E DO NOT INCLUDE MOLD FLASH.
  2. MOLD FLASH OR PROTRUSIONS NOT TO EXCEED 0.15MM (.006").
  3. CONTROLLING DIMENSION: MILLIMETERS.
  4. MEETS JEDEC MO-187.

<b>MAXIM</b>			
<small>PROPRIETARY INFORMATION</small>			
<small>TITLE</small>			
PACKAGE OUTLINE, 8L uMAX			
<small>APPROVAL</small>	<small>DOCUMENT CONTROL NO.</small>	<small>REV</small>	<small>1/1</small>
	21-0036	I	