

## Micropower, Single-Supply, UCSP/SOT23 Comparator + Precision Reference ICs

## MAX9038–MAX9043/ MAX9050–MAX9053

### General Description

The MAX9038–MAX9043 and MAX9050–MAX9053 feature combinations of low-power comparators and precision voltage references. Their operating voltage range makes them ideal for both 3V and 5V systems. The MAX9038/MAX9039/MAX9040/MAX9041/MAX9050/MAX9051 have a single comparator and reference consuming only 40µA of supply current. The MAX9042/MAX9043/MAX9052/MAX9053 have dual comparators and one reference, and consume only 55µA of supply current. Low-voltage operation and low supply current make these devices ideal for battery-operated systems.

The comparators feature rail-to-rail inputs and outputs, with a common-mode input voltage range that extends 250mV beyond the supply rails. Input bias current is typically 1.0pA, and input offset voltage is typically 0.5mV. Internal hysteresis ensures clean output switching, even with slow-moving input signals. The output stage features a unique design that limits supply current surges while switching, virtually eliminating supply glitches typical of many other comparators. This design also minimizes overall power consumption under dynamic conditions. The comparator outputs have rail-to-rail, push-pull output stages except the MAX9038 has an open-drain output that sinks and sources up to 8mA. The propagation delay is 400ns, even with the low-operating supply current.

The reference output voltage is set to 1.23V in the MAX9038/MAX9039, to 2.048V in the MAX9040–MAX9043, and to 2.500V in the MAX9050–MAX9053. The MAX9040–MAX9043 and the MAX9050–MAX9053 are offered in two grades: an A grade with 0.4% initial accuracy and 6ppm/°C tempco, and a B grade with 1% initial accuracy (except MAX9038/MAX9039 have an initial accuracy of ±0.4%) and 100ppm/°C tempco. The voltage references feature a proprietary curvature-correction circuit and laser-trimmed thin-film resistors. These series-mode references can sink or source up to 500µA of load current.

### Applications

- Precision Battery Management
- Window Comparators
- IR Receivers
- Level Translators
- Digital Line Receivers

*Typical Operating Circuit and Functional Diagrams appear at end of data sheet.*

UCSP is a trademark of Maxim Integrated Products, Inc.

### Features

- Comparator + Precision Reference in UCSP/SOT23
- 2.5V to 5.5V Single-Supply Operation (MAX9038–MAX9043)
- Low Supply Current (MAX9038/MAX9039/MAX9040/MAX9041/MAX9050/MAX9051)
  - 40µA Quiescent
  - 50µA with 100kHz Switching
  - Open-Drain Output MAX9038
- 400ns Propagation Delay
- Rail-to-Rail Inputs
- Rail-to-Rail Output Stage Sinks and Sources 8mA
- Internal ±3mV Hysteresis
- Voltage Reference Offers
  - ±0.4% (max) Initial Accuracy (A Grade)
  - 6ppm/°C (typ) Temperature Coefficient (A Grade)
  - Stable for 0 to 4.7nF Capacitive Loads

### Ordering Information

PART	TEMP RANGE	PIN-PACKAGE	TOP MARK
MAX9038BABT+T	-40°C to +125°C	6 UCSP	ADW
MAX9039BEBT+T	-40°C to +85°C	6 UCSP	AAZ
MAX9039BEBT+T10	-40°C to +85°C	6 UCSP	AAZ
MAX9040AEUK+T	-40°C to +85°C	5 SOT23	ADNV
MAX9040BEUK+T	-40°C to +85°C	5 SOT23	ADNX
MAX9041AEUT+T	-40°C to +85°C	6 SOT23	AAHF
MAX9041BEUT+T	-40°C to +85°C	6 SOT23	AAHH
MAX9041AESA	-40°C to +85°C	8 SO	—
MAX9041BESA	-40°C to +85°C	8 SO	—

+Denotes lead (Pb)-free/RoHS-compliant package.

[Ordering Information](#) continued at end of data sheet.  
[Selector Guide](#) appears at end of data sheet.

### Pin Configurations

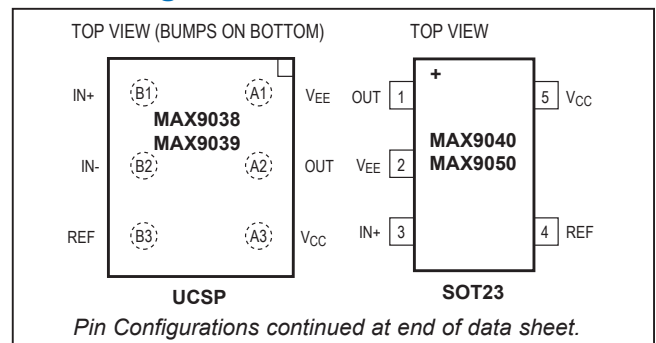

19-1569; Rev 12; 10/21

# MAX9038–MAX9043/ MAX9050–MAX9053

# Micropower, Single-Supply, UCSP/SOT23 Comparator + Precision Reference ICs

## Absolute Maximum Ratings

Supply Voltage ( $V_{CC}$ to $V_{EE}$ )	.....-0.3V to +6V	8-Pin SO (derate 5.88mW/°C above +70°C)	.....471mW
OUT (MAX9038)	.....-0.3V to +6V	8-Pin $\mu$ MAX® (derate 4.1mW/°C above +70°C)	.....330mW
All Other Pins	.....( $V_{EE} - 0.3V$ ) to ( $V_{CC} + 0.3V$ )	10-Pin $\mu$ MAX (derate 5.6mW/°C above +70°C)	.....444mW
Current into Input Pins	..... $\pm 20mA$	Operating Temperature Range:	
Output Short-Circuit Duration		MAX9039-43, MAX9051-53	.....-40°C to +85°C
(OUT <sub>-</sub> , REF)	.....Indefinite Short Circuit to Either Supply	MAX9038, MAX9050	.....-40°C to +125°C
Continuous Power Dissipation ( $T_A = +70^\circ C$ )		Junction Temperature	.....+150°C
5-Pin SOT23 (derate 7.10mW/°C above +70°C)	.....571mW	Storage Temperature Range	.....-65°C to +150°C
6-Bump UCSP (derate 3.9mW/°C above +70°C)	.....308mW	Lead Temperature (soldering, 10s)	.....+300°C
6-Pin SOT23 (derate 8.70mW/°C above +70°C)	.....696mW	Bump Reflow Temperature (Note 1)	.....+235°C

**Note 1:** This device is constructed using a unique set of packaging techniques that impose a limit on the thermal profile the device can be exposed to during board-level solder attach and rework. This limit permits only the use of the solder profiles recommended in the industry-standard specification, JEDEC 020A, paragraph 7.6, Table 3 for IR/VPR and Convection Packaging Reflow. Preheating is required. Hand or wave soldering is not allowed.

Stresses beyond those listed under "Absolute Maximum Ratings" may cause permanent damage to the device. These are stress ratings only, and functional operation of the device at these or any other conditions beyond those indicated in the operational sections of the specifications is not implied. Exposure to absolute maximum rating conditions for extended periods may affect device reliability.

## Electrical Characteristics—A Grade (0.4% Initial Accuracy)

( $V_{CC} = +5V$ ,  $V_{EE} = 0V$ ,  $V_{CM} = 0V$ ,  $I_{OUT} = 0A$ ,  $I_{REF} = 0A$ ,  $T_A = -40^\circ C$  to  $+85^\circ C$  for MAX9040-43A\_/MAX9051-53A\_,  $T_A = -40^\circ C$  to  $+125^\circ C$  for MAX9050A\_, unless otherwise noted. Typical values are at  $T_A = +25^\circ C$ .) (Note 2)

PARAMETER	SYMBOL	CONDITIONS		MIN	TYP	MAX	UNITS
Supply Voltage Range (Note 3)	$V_{CC}$	MAX9040–MAX9043		2.5		5.5	V
		MAX9050–MAX9053		2.7		5.5	
Supply Current	$I_{CC}$	MAX9040/MAX9041/ MAX9050/MAX9051	$V_{CC} = 2.7V$		47	67	$\mu A$
			$V_{CC} = 5V$		52	72	
		MAX9042/MAX9043/ MAX9052/MAX9053	$V_{CC} = 2.7V$		55	80	
			$V_{CC} = 5V$		60	85	
<b>COMPARATORS</b>							
Input Offset Voltage (Note 4)	$V_{OS}$	Over entire common-mode range	$T_A = +25^\circ C$		$\pm 0.5$	$\pm 5.0$	mV
			$T_A = -40^\circ C$ to $+85^\circ C$			$\pm 7.0$	
Input Hysteresis	$V_{HYST}$				$\pm 3.0$		mV
Input Bias Current (Notes 5, 6, 7)	$I_B$	Specified common-mode range			$\pm 0.001$	$\pm 10.0$	nA
Input Offset Current (Note 5)	$I_{OS}$	Specified common-mode range			$\pm 0.5$		pA
Common-Mode Voltage Range (Notes 5, 8)	CMVR	$T_A = +25^\circ C$		$V_{EE} - 0.25$		$V_{CC} + 0.25$	V
		$T_A = -40^\circ C$ to $+85^\circ C$		$V_{EE}$		$V_{CC}$	
Common-Mode Rejection Ratio (Note 5)	CMRR	Specified common-mode range		52	80		dB
Power-Supply Rejection Ratio	PSRR	MAX9040–MAX9043, $2.5V \leq V_{CC} \leq 5.5V$		55	80		dB
		MAX9050–MAX9053, $2.5V \leq V_{CC} \leq 5.5V$		55	80		
Input Capacitance (Note 5)	$C_{IN}$				2.5		pF
Output Short-Circuit Current	$I_{SC}$	$V_{OUT} = V_{EE}$ or $V_{CC}$	$V_{CC} = 5V$		95		mA
			$V_{CC} = 2.7V$		35		
Output Voltage Low	$V_{OL}$	$V_{CC} = 5V$ , $I_{SINK} = 8mA$			0.2	0.55	V
		$V_{CC} = 2.7V$ , $I_{SINK} = 3.5mA$			0.15	0.4	

$\mu$ MAX is a registered trademark of Maxim Integrated Products, Inc.

**MAX9038–MAX9043/  
MAX9050–MAX9053**

**Micropower, Single-Supply, UCSP/SOT23  
Comparator + Precision Reference ICs**

**Electrical Characteristics —A Grade (0.4% Initial Accuracy) (continued)**

( $V_{CC} = +5V$ ,  $V_{EE} = 0V$ ,  $V_{CM} = 0V$ ,  $I_{OUT} = 0A$ ,  $I_{REF} = 0A$ ,  $T_A = -40^\circ C$  to  $+85^\circ C$  for MAX9040-43A\_/MAX9051-53A\_,  $T_A = -40^\circ C$  to  $+125^\circ C$  for MAX9050A\_, unless otherwise noted. Typical values are at  $T_A = +25^\circ C$ .) (Note 2)

PARAMETER	SYMBOL	CONDITIONS		MIN	TYP	MAX	UNITS
Output Voltage High	$V_{OH}$	$V_{CC} = 5V$ , $I_{SOURCE} = 8mA$		4.45	4.85		V
		$V_{CC} = 2.7V$ , $I_{SOURCE} = 3.5mA$		2.3	2.55		
Output Rise/Fall Times	$t_R/t_F$	$C_L = 15pF$			40		ns
		$C_L = 50pF$			50		
		$C_L = 200pF$			80		
Output Propagation Delay (Note 9)	$t_{PD+}/t_{PD-}$	$C_L = 15pF$ , $V_{CC} = 2.7V$	50mV overdrive		450		ns
			100mV overdrive		400		
Power-Up Time	$t_{PU}$	Time to $V_{OUT}$ valid logic state			20		$\mu s$
<b>VOLTAGE REFERENCE</b>							
Output Voltage	$V_{REF}$	$T_A = +25^\circ C$	MAX9040–MAX9043	2.040	2.048	2.056	V
			MAX9050–MAX9053	2.490	2.500	2.510	
Output Voltage Temperature Coefficient (Note 10)	$TCV_{REF}$	$\mu MAX/SO$			6	30	ppm/ $^\circ C$
		SOT23			6	50	
Line Regulation	$\Delta V_{REF}/\Delta V_{CC}$	$2.5V \leq V_{CC} \leq 5.5V$ , MAX9040–MAX9043			+50	+200	$\mu V/V$
		$2.7V \leq V_{CC} \leq 5.5V$ , MAX9050–MAX9053			+50	+200	
Load Regulation	$\Delta V_{REF}/\Delta I_{REF}$	Sourcing, $0\mu A \leq I_{REF} \leq 500\mu A$			2	4	$\mu V/\mu A$
		Sinking, $-500\mu A \leq I_{REF} \leq 0\mu A$			3.5	6	
Output Short-Circuit Current	$I_{SC}$	$V_{REF} = V_{EE}$ or $V_{CC}$			4		mA
Thermal Hysteresis (Note 11)	THYST				130		ppm
Long-Term Stability		1000h at $T_A = +25^\circ C$			50		ppm
Noise Voltage	$E_{OUT}$	$f = 0.1Hz$ to $10Hz$			40		$\mu V_{P-P}$
		$f = 10Hz$ to $10kHz$			105		$\mu V_{RMS}$
Ripple Rejection	$\Delta V_{REF}/\Delta V_{CC}$	$V_{CC} = 5V \pm 100mV$ , $f = 120Hz$			84		dB
Turn-On Settling Time	$t_R(V_{REF})$	To $V_{REF} = 1\%$ of final value			200		$\mu s$
Capacitive-Load Stability Range (Note 7)	$C_L(V_{REF})$			0		4.7	nF

**Electrical Characteristics—B Grade (1% Initial Accuracy) (Note 12)**

( $V_{CC} = 5V$ ,  $V_{EE} = 0V$ ,  $V_{CM} = 0V$ ,  $V_{PU} = 1.8V$ ,  $R_{PU} = 10k\Omega$ ,  $I_{OUT} = 0A$ ,  $I_{REF} = 0A$ ,  $T_A = -40^\circ C$  to  $+85^\circ C$  for MAX9039-43B\_/MAX9050-53B\_,  $T_A = -40^\circ C$  to  $+125^\circ C$  for MAX9038B\_, unless otherwise noted. Typical values are at  $T_A = +25^\circ C$ .) (Note 2)

PARAMETER	SYMBOL	CONDITIONS		MIN	TYP	MAX	UNITS
Supply Voltage Range (Note 3)	$V_{CC}$	MAX9038–MAX9043		2.5		5.5	V
		MAX9050–MAX9053		2.7		5.5	
Supply Current	$I_{CC}$	MAX9038/MAX9039/ MAX9040/MAX9041/ MAX9050/MAX9051	$V_{CC} = 2.7V$		40		$\mu A$
			$V_{CC} = 5.0V$		45	100	
		MAX9042/MAX9043/ MAX9052/MAX9053	$V_{CC} = 2.7V$		55		
			$V_{CC} = 5.0V$		60	130	

**Electrical Characteristics—B Grade (1% Initial Accuracy) (Note 12) (continued)**

( $V_{CC} = 5V$ ,  $V_{EE} = 0V$ ,  $V_{CM} = 0V$ ,  $V_{PU} = 1.8V$ ,  $R_{PU} = 10k\Omega$ ,  $I_{OUT} = 0A$ ,  $I_{REF} = 0A$ ,  $T_A = -40^\circ C$  to  $+85^\circ C$  for MAX9039–43B\_MAX9050–53B\_,  $T_A = -40^\circ C$  to  $+125^\circ C$  for MAX9038B\_, unless otherwise noted. Typical values are at  $T_A = +25^\circ C$ .) (Note 2)

PARAMETER	SYMBOL	CONDITIONS	MIN	TYP	MAX	UNITS	
<b>COMPARATOR</b>							
Input Offset Voltage (Note 4)	$V_{OS}$	Over entire common-mode range		±1	±9.0	mV	
Input Hysteresis	$V_{HYST}$			±3.0		mV	
Input Bias Current (Notes 5, 6, 7)	$I_B$	Specified common-mode range		±0.001	±25.0	nA	
Input Offset Current (Note 5)	$I_{OS}$	Specified common-mode range		±0.5		pA	
Common-Mode Voltage Range (Notes 5, 8)	CMVR		$V_{EE}$		$V_{CC}$	V	
Common-Mode Rejection Ratio (Note 5)	CMRR	Specified common-mode range	52	80		dB	
Power-Supply Rejection Ratio	PSRR	MAX9038–MAX9043, $2.5V \leq V_{CC} \leq 5.5V$	55	80		dB	
		MAX9050–MAX9053, $2.7V \leq V_{CC} \leq 5.5V$	55	80			
Input Capacitance (Note 5)	$C_{IN}$			2.5		pF	
Output Short-Circuit Current	$I_{SC}$	$V_{OUT} = V_{EE}$ or $V_{CC}$	$V_{CC} = 5V$	95		mA	
			$V_{CC} = 2.7V$	35			
Output Voltage Low	$V_{OL}$	$V_{CC} = 5V$ , $I_{SINK} = 8mA$		0.2	0.55	V	
		$V_{CC} = 2.7V$ , $I_{SINK} = 3.5mA$		0.15			
Output Voltage High (Except MAX9038)	$V_{OH}$	$V_{CC} = 5V$ , $I_{SOURCE} = 8mA$	4.45	4.85		V	
		$V_{CC} = 2.7V$ , $I_{SOURCE} = 3.5mA$		2.55			
Output Leakage		MAX9038			0.5	μA	
Output Rise/Fall Times	$t_R/t_F$	$C_L = 15pF$		40		ns	
		$C_L = 50pF$		50			
		$C_L = 200pF$		80			
Output Rise Time	$t_R$	$R_{PU} = 10k\Omega$ , $C_L = 15pF$ , MAX9038		400		ns	
		$R_{PU} = 10k\Omega$ , $C_L = 50pF$ , MAX9038		1180			
		$R_{PU} = 10k\Omega$ , $C_L = 200pF$ , MAX9038		5580			
Output Propagation Delay (Note 9)	$t_{PD+}/t_{PD-}$	$C_L = 15pF$ , $V_{CC} = 2.7V$	50mV overdrive	450		ns	
			100mV overdrive	400			
Output Rising Propagation Delay (Note 9)	$t_{PD+}$	$R_{PU} = 10k\Omega$ , $C_L = 15pF$ , MAX9038		500		ns	
		$R_{PU} = 10k\Omega$ , $C_L = 50pF$ , MAX9038		1540			
		$R_{PU} = 10k\Omega$ , $C_L = 200pF$ , MAX9038		3350			
Power-Up Time	$t_{PU}$	Time to $V_{OUT}$ valid logic state		20		μs	
<b>VOLTAGE REFERENCE</b>							
Output Voltage	$V_{REF}$	$T_A = +25^\circ C$	MAX9038/MAX9039 (Note 12)	1.225	1.230	1.235	V
			MAX9040–MAX9043	2.028	2.048	2.068	
			MAX9050–MAX9053	2.475	2.500	2.525	
Output Voltage Temperature Coefficient (Note 10)	$TCV_{REF}$			20	100	ppm/°C	

**Electrical Characteristics—B Grade (1% Initial Accuracy) (Note 12) (continued)**

( $V_{CC} = 5V$ ,  $V_{EE} = 0V$ ,  $V_{CM} = 0V$ ,  $V_{PU} = 1.8V$ ,  $R_{PU} = 10k\Omega$ ,  $I_{OUT} = 0A$ ,  $I_{REF} = 0A$ ,  $T_A = -40^\circ C$  to  $+85^\circ C$  for MAX9039–43B\_MAX9050–53B\_,  $T_A = -40^\circ C$  to  $+125^\circ C$  for MAX9038B\_, unless otherwise noted. Typical values are at  $T_A = +25^\circ C$ .) (Note 2)

PARAMETER	SYMBOL	CONDITIONS	MIN	TYP	MAX	UNITS	
Line Regulation	$\Delta V_{REF}/\Delta V_{CC}$	$2.5V \leq V_{CC} \leq 5.5V$	MAX9038–MAX9043		+50	+200	$\mu V/V$
			MAX9050–MAX9053		+50	+200	
Load Regulation	$\Delta V_{REF}/\Delta I_{REF}$	Sourcing: $0\mu A \leq I_{REF} \leq 500\mu A$			2	4	$\mu V/\mu A$
		Sinking: $-500\mu A \leq I_{REF} \leq 0\mu A$			3.5	6	
Output Short-Circuit Current	$I_{SC}$	$V_{REF} = V_{EE}$ or $V_{CC}$			4	mA	
Thermal Hysteresis (Note 11)	$T_{HYST}$				130	ppm	
Long-Term Stability		1000h at $T_A = +25^\circ C$			100	ppm	
Ripple Rejection	$\Delta V_{REF}/\Delta V_{CC}$	$V_{CC} = 5V \pm 100mV$ , $f = 120Hz$			84	dB	
Turn-On Settling Time	$t_R(V_{REF})$	To $V_{REF} = 1\%$ of final value			200	$\mu s$	
Capacitive Load Stability Range (Note 7)	$C_L(V_{REF})$		0	4.7		nF	

**Note 2:** All devices are 100% production tested at  $T_A = +25^\circ C$ . Limits over the extended temperature range are guaranteed by design.

**Note 3:** Supply voltage range guaranteed by PSRR test on comparator and line regulation of REF.

**Note 4:**  $V_{OS}$  is defined as the center of the input-referred hysteresis band.

**Note 5:** For the comparators with the inverting input (IN-) uncommitted.

**Note 6:** Input bias current is the average of the inverting and noninverting input bias currents.

**Note 7:** Not production tested. Guaranteed by design.

**Note 8:** Guaranteed by CMRR test.

**Note 9:**  $V_{OVERDRIVE}$  is beyond the offset and hysteresis determined trip point.

**Note 10:** Temperature coefficient is measured by the box method; i.e., the maximum  $\Delta V_{REF}$  is divided by the maximum  $\Delta T$ .

**Note 11:** Thermal hysteresis is defined as the change in  $V_{REF}$  at  $+25^\circ C$  before and after cycling the device from  $T_{MIN}$  to  $T_{MAX}$ .

**Note 12:** MAX9038/MAX9039 has an initial accuracy of  $\pm 0.4\%$ .

**Typical Operating Characteristics**

( $V_{CC} = 5V$ ,  $V_{EE} = 0V$ ,  $V_{CM} = 0V$ ,  $V_{PU} = 1.8V$ ,  $R_{PU} = 10k\Omega$ ,  $I_{OUT} = 0A$ ,  $I_{REF} = 0A$ ,  $T_A = +25^\circ C$ , unless otherwise noted.)

MAX9039/MAX9040/MAX9041/MAX9050/MAX9051  
SUPPLY CURRENT vs. TEMPERATURE

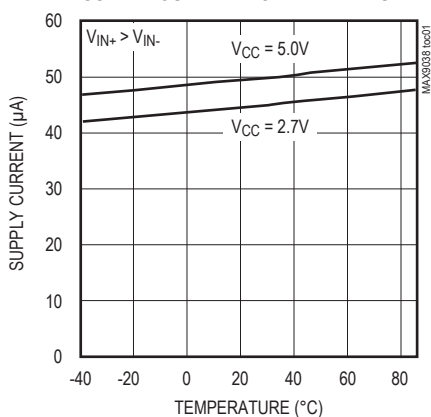

MAX9042/MAX9043/MAX9052/MAX9053  
SUPPLY CURRENT vs. TEMPERATURE

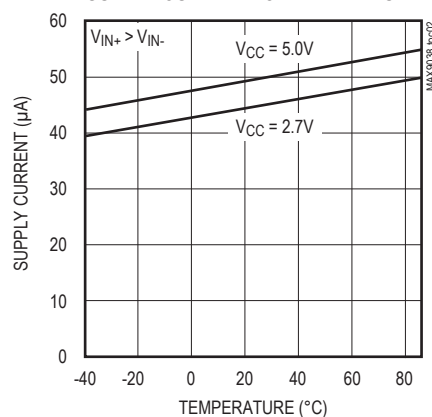

MAX9039/MAX9040/MAX9041/MAX9050/MAX9051  
SUPPLY CURRENT vs. SWITCHING FREQUENCY

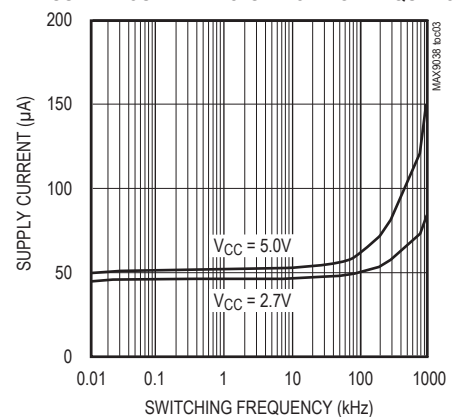

**Typical Operating Characteristics (continued)**

( $V_{CC} = 5V$ ,  $V_{EE} = 0V$ ,  $V_{CM} = 0V$ ,  $V_{PU} = 1.8V$ ,  $R_{PU} = 10k\Omega$ ,  $I_{OUT} = 0A$ ,  $I_{REF} = 0A$ ,  $T_A = +25^\circ C$ , unless otherwise noted.)

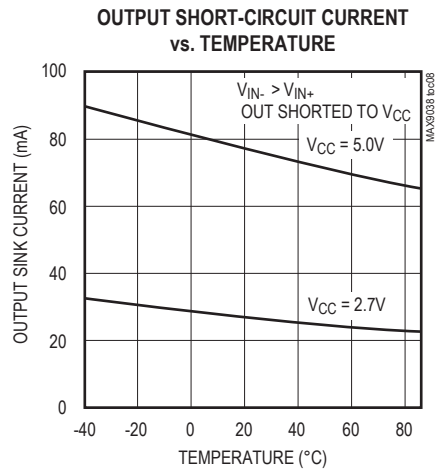
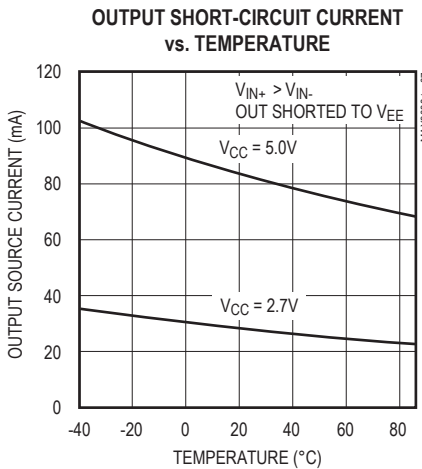
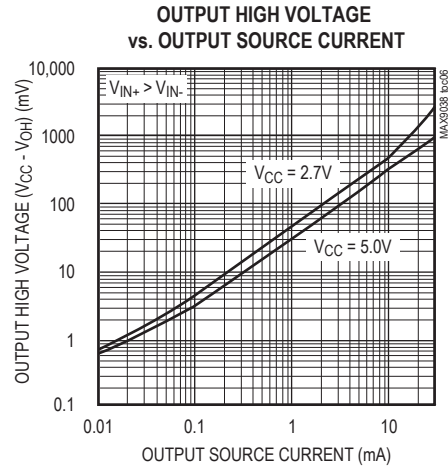
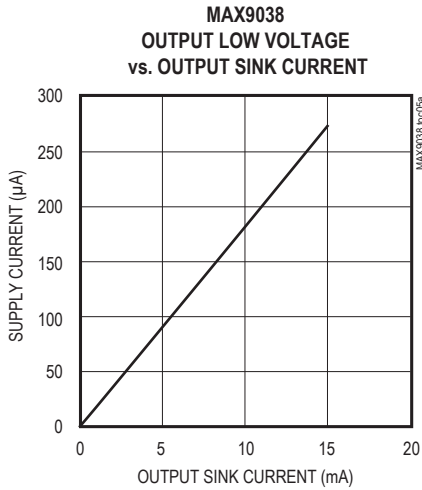
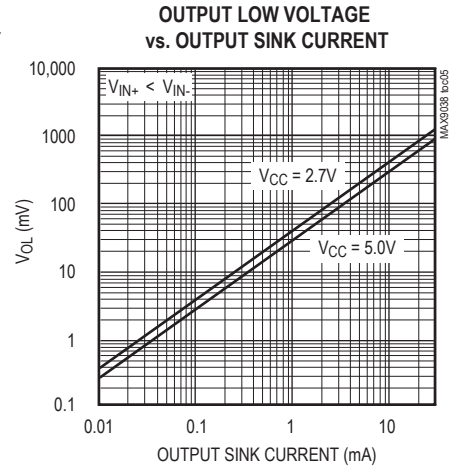
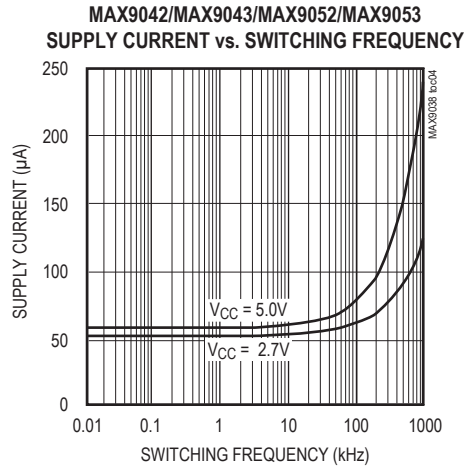
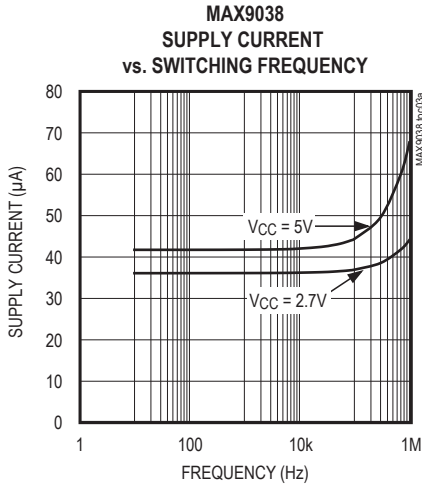

**Typical Operating Characteristics (continued)**

( $V_{CC} = 5V$ ,  $V_{EE} = 0V$ ,  $V_{CM} = 0V$ ,  $V_{PU} = 1.8V$ ,  $R_{PU} = 10k\Omega$ ,  $I_{OUT} = 0A$ ,  $I_{REF} = 0A$ ,  $T_A = +25^\circ C$ , unless otherwise noted.)

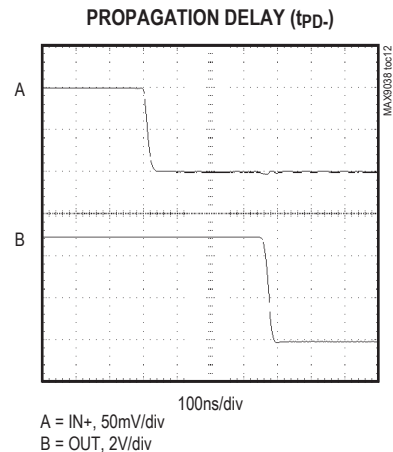
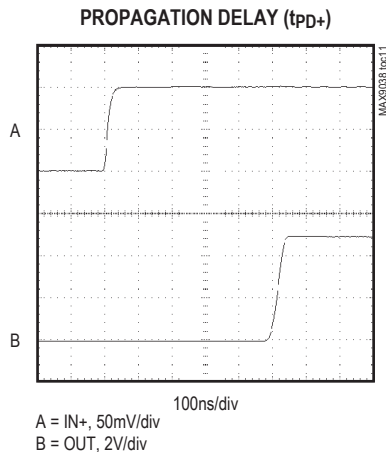
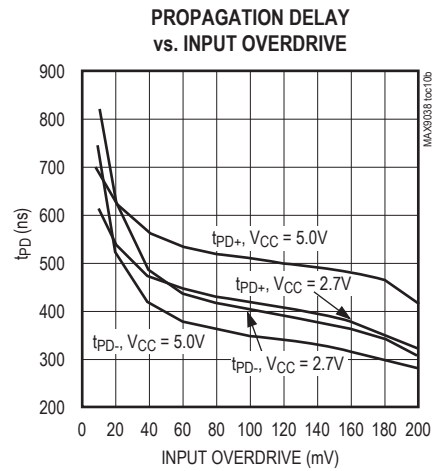
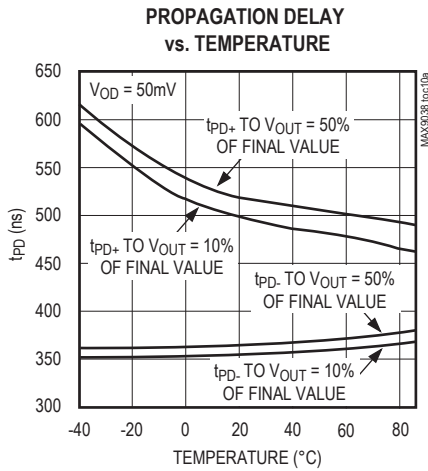
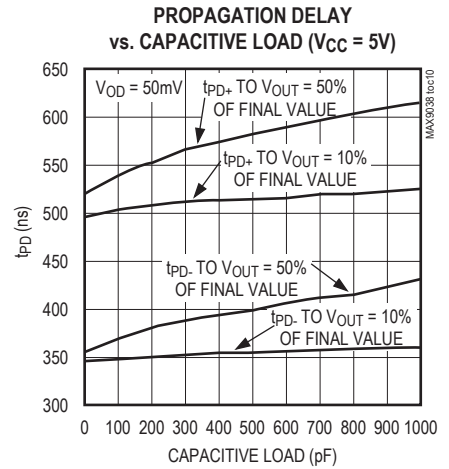
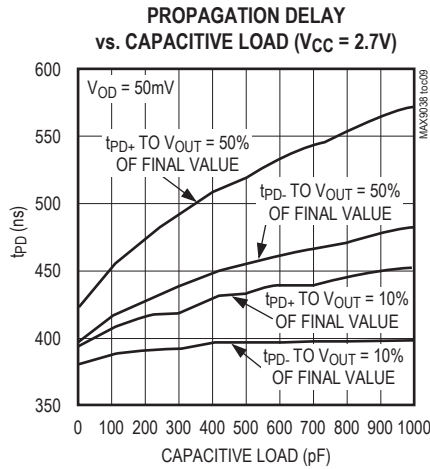
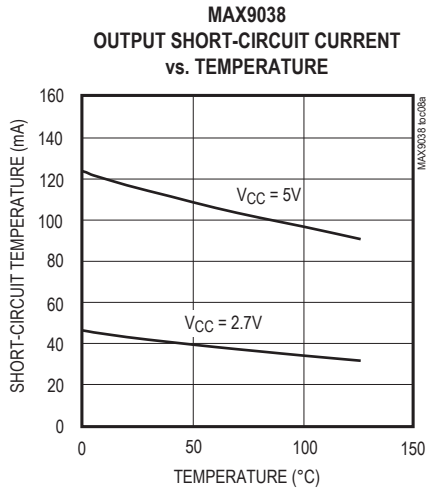

**Typical Operating Characteristics (continued)**

( $V_{CC} = 5V$ ,  $V_{EE} = 0V$ ,  $V_{CM} = 0V$ ,  $V_{PU} = 1.8V$ ,  $R_{PU} = 10k\Omega$ ,  $I_{OUT} = 0A$ ,  $I_{REF} = 0A$ ,  $T_A = +25^\circ C$ , unless otherwise noted.)

**SWITCHING CURRENT (OUT RISING EDGE)**

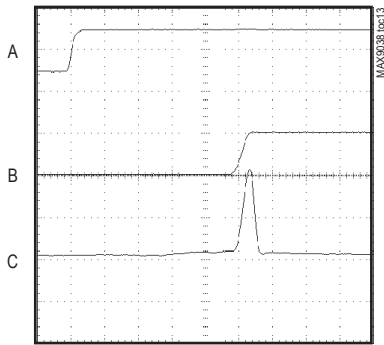

100ns/div  
A = IN+, 100mV/div  
B = OUT, 5V/div  
C = I<sub>CC</sub>, 1mA/div

**SWITCHING CURRENT (OUT FALLING EDGE)**

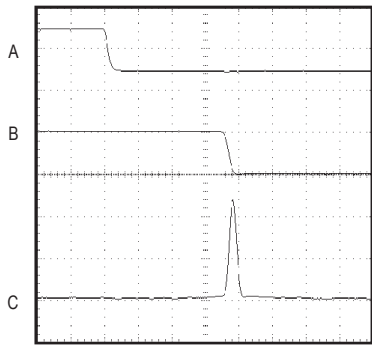

100ns/div  
A = IN+, 100mV/div  
B = OUT, 5V/div  
C = I<sub>CC</sub>, 1mA/div

**POWER-UP DELAY (OUT)**

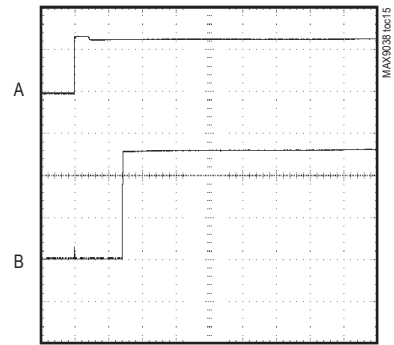

5ms/div  
A = V<sub>CC</sub>, 2V/div  
B = OUT, 1V/div

**POWER-UP DELAY (REF)**

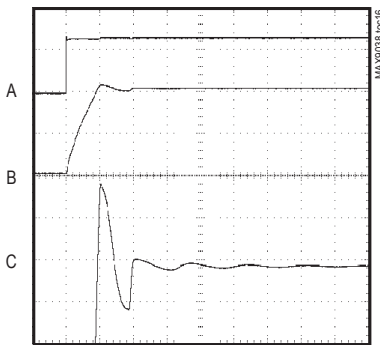

100μs/div  
A = V<sub>CC</sub>, 2V/div  
B = REF, 1V/div  
C = REF, 50mV/div, 2.048V OFFSET

**INPUT BIAS CURRENT  
vs. INPUT VOLTAGE**

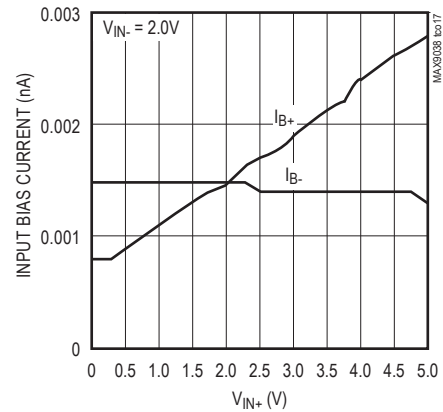

**MAX904 /MAX905  
REFERENCE OUTPUT VOLTAGE  
TEMPERATURE DRIFT**

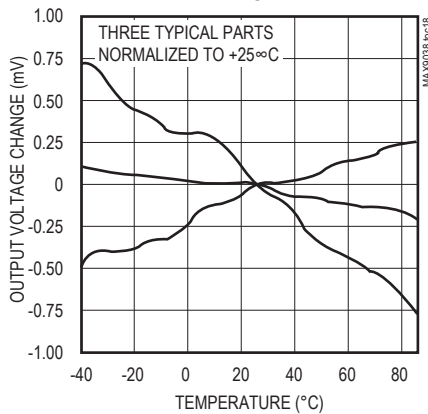

**MAX9039  
REFERENCE OUTPUT VOLTAGE  
TEMPERATURE DRIFT**

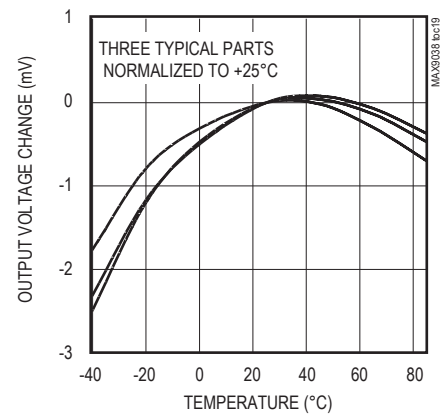



**Typical Operating Characteristics (continued)**

( $V_{CC} = 5V$ ,  $V_{EE} = 0V$ ,  $V_{CM} = 0V$ ,  $V_{PU} = 1.8V$ ,  $R_{PU} = 10k\Omega$ ,  $I_{OUT} = 0A$ ,  $I_{REF} = 0A$ ,  $T_A = +25^\circ C$ , unless otherwise noted.)

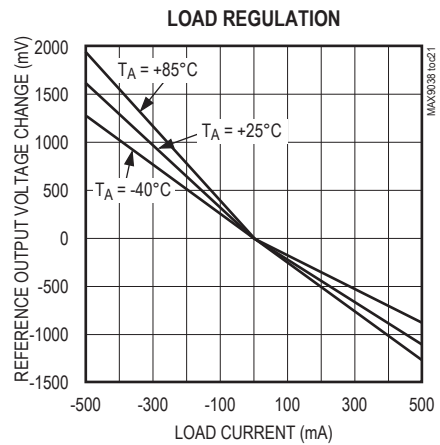
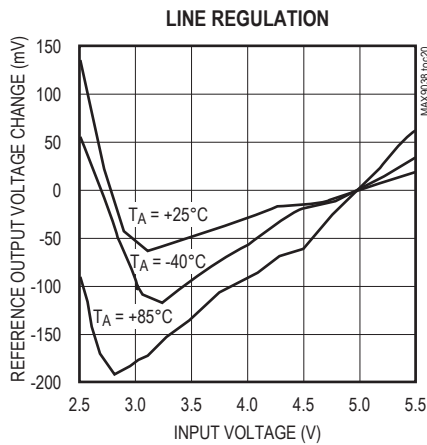

**Pin Description**

PIN						NAME	FUNCTION
MAX9038 MAX9039	MAX9040 MAX9050	MAX9041 MAX9051		MAX9042 MAX9052	MAX9043 MAX9053		
UCSP	SOT23	SOT23	SO	SO/ $\mu$ MAX	$\mu$ MAX		
A2	1	1	6	—	—	OUT	Comparator Output
A1	2	2	4	4	5	$V_{EE}$	Negative Supply Voltage
B1	3	3	3	—	—	IN+	Comparator Noninverting Input
B3	4	5	1	2	2	REF	Reference Voltage Output
A3	5	6	7	8	10	$V_{CC}$	Positive Supply Voltage
B2	—	4	2	—	—	IN-	Comparator Inverting Input
—	—	—	5, 8	—	9	N.C.	No Connection. Not internally connected.
—	—	—	—	1	1	OUTA	Comparator A Output
—	—	—	—	3	4	INA+	Comparator A Noninverting Input
—	—	—	—	5	6	INB+	Comparator B Noninverting Input
—	—	—	—	6	7	INB-	Comparator B Inverting Input
—	—	—	—	7	8	OUTB	Comparator B Output
—	—	—	—	—	3	INA-	Comparator A Inverting Input

## MAX9038–MAX9043/ MAX9050–MAX9053

### Detailed Description

The MAX9038–MAX9043 and MAX9050–MAX9053 feature single/dual, low-power, low-voltage comparators and a precision voltage reference. They operate from a single 2.5V to 5.5V (MAX903\_/MAX904\_) or 2.7V to 5.5V (MAX905\_) supply. The single comparators with reference, (MAX9038/MAX9039/MAX9040/MAX9041/MAX9050/MAX9051) consume only 40µA of supply current, while the dual comparators with reference (MAX9042/MAX9043/MAX9052/MAX9053) consume only 55µA of supply current. Their common-mode input range extends 0.25V beyond each rail. Internal hysteresis ensures clean output switching, even with slow-moving input signals.

The output stage employs a unique design that minimizes supply current surges while switching, virtually eliminating the supply glitches typical of many other comparators. Large internal output drivers allow rail-to-rail output swing that can sink and source up to 8mA of current.

The precision reference uses a proprietary curvature-correction circuit and laser-trimmed thin-film resistors, resulting in a temperature coefficient of less than 30ppm/°C over the extended temperature range and initial accuracy of 0.4% (A grade). The reference output voltage is set to 1.23V in the MAX9038/MAX9039, 2.048V in the MAX9040–MAX9043, and to 2.500V in the MAX9050–MAX9053.

### Comparator Input Stage Circuitry

The devices' input common-mode range extends from ( $V_{EE} - 0.25V$ ) to ( $V_{CC} + 0.25V$ ). These comparators may operate at any differential input voltage within these limits. Input bias current is typically 1.0pA if the input voltage is between the supply rails. Comparator inputs are protected from overvoltage by internal body diodes connected to the supply rails. As the input voltage exceeds the supply rails,

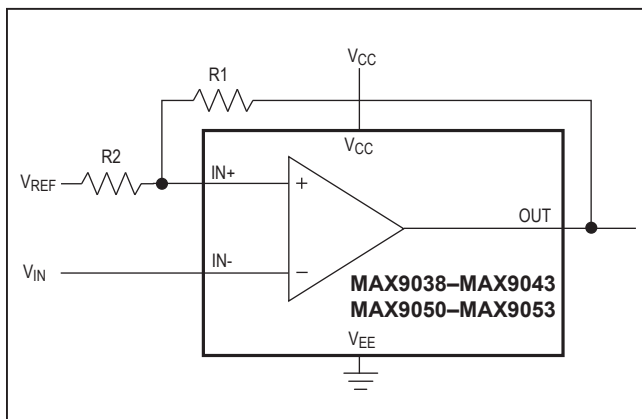

Figure 1. Additional Hysteresis

## Micropower, Single-Supply, UCSP/SOT23 Comparator + Precision Reference ICs

these body diodes become forward biased and begin to conduct. Consequently, bias currents increase exponentially as the input voltage exceeds the supply rails.

### Comparator Output Stage Circuitry

The comparators in these devices contain a unique output stage capable of rail-to-rail operation with loads up to 8mA. Many comparators consume orders-of-magnitude more current during switching than during steady-state operation. However, with this family of comparators, the supply current change during an output transition is extremely small. The *Typical Operating Characteristics* graph Supply Current vs. Switching Frequency shows the minimal supply current increase as the output switching frequency approaches 1MHz. This characteristic reduces the need for power-supply filter capacitors to reduce glitches created by comparator switching currents. Another advantage realized in high-speed, battery-powered applications is a substantial increase in battery life. The MAX9038 is an opendrain output comparator that can be used in logic-level translation or many other applications where voltage level translation is important.

### Applications Information

#### Additional Hysteresis

These comparators have ±3mV internal hysteresis. Additional hysteresis can be generated with two resistors using positive feedback (Figure 1). Use the following procedure to calculate resistor values:

- 1) Calculate the trip points of the comparator using these formulas:

$$V_{TH} = V_{REF} + \left( \frac{(V_{CC} - V_{REF})R_2}{R_1 + R_2} \right)$$

$$V_{TL} = V_{REF} \left( 1 - \frac{R_2}{R_1 + R_2} \right)$$

$V_{TH}$  is the threshold voltage at which the comparator switches its output from high to low as  $V_{IN}$  rises above the trip point.  $V_{TL}$  is the threshold voltage at which the comparator switches its output from low to high as  $V_{IN}$  drops below the trip point.

- 2) The hysteresis band will be:
- 3) In this example, let  $V_{CC} = 5V$  and  $V_{REF} = 2.5V$ :

$$V_{HYS} = V_{TH} - V_{TL} = V_{CC} \left( \frac{R_2}{R_1 + R_2} \right)$$

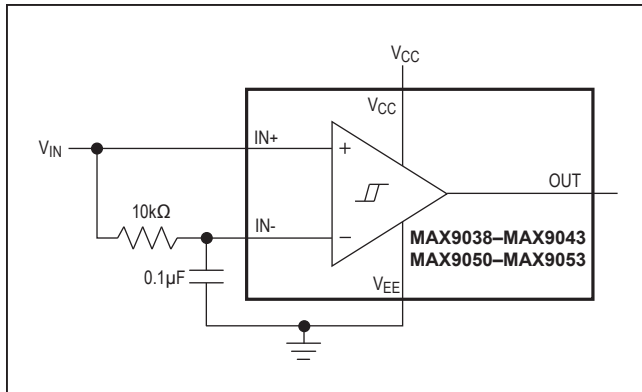

Figure 2. Time Averaging of the Input Signal for Data Recovery

$$V_{TH} = 2.5 + 2.5 \left( \frac{R2}{R1 + R2} \right)$$

and

$$V_{TL} = 2.5 \left( 1 - \frac{R2}{R1 + R2} \right)$$

- 4) Select R2. In this example, we will choose 1kΩ.
- 5) Select V<sub>HYS</sub>. In this example, we will choose 50mV.
- 6) Solve for R1:

$$V_{HYS} = V_{CC} \left( \frac{R2}{R1 + R2} \right)$$

$$0.050 = 5 \left( \frac{1000}{R1 + 1000} \right)$$

where R1 ≈ 100kΩ, V<sub>TH</sub> = 2.525V, and V<sub>TL</sub> = 2.475V.

### Board Layout and Bypassing

Power-supply bypass capacitors are not typically needed, but would be called for in cases where supply impedance is high, supply leads are long, or excessive noise is expected on the supply lines. Use 100nF bypass capacitors under these conditions. Minimize signal trace lengths to reduce stray capacitance.

### Reference Output/Load Capacitance

The MAX9038/MAX9039/MAX904\_/MAX905\_ do not require an output capacitor on REF for frequency stability. They are stable for capacitive loads up to 4.7nF. However, in applications where the load or the supply can experience step changes, an output capacitor will reduce the amount of overshoot (or undershoot) and assist the circuit's transient response. When an application is not subject to transient conditions, the REF capacitor can be omitted.

### Biasing for Data Recovery

Digital data is often embedded into a bandwidth- and amplitude-limited analog path. Recovering the data can be difficult. Figure 2 compares the input signal to a time-averaged version of itself. This self-biases the threshold to the average input voltage for optimal noise margin.

Even severe phase distortion is eliminated from the digital output signal. Be sure to choose R1 and C1 so that:

$$f_{CAR} \gg \frac{1}{2\pi R1 C1}$$

where f<sub>CAR</sub> is the fundamental carrier frequency of the digital data stream.

# MAX9038–MAX9043/ MAX9050–MAX9053

Micropower, Single-Supply, UCSP/SOT23  
Comparator + Precision Reference ICs

## Functional Diagrams

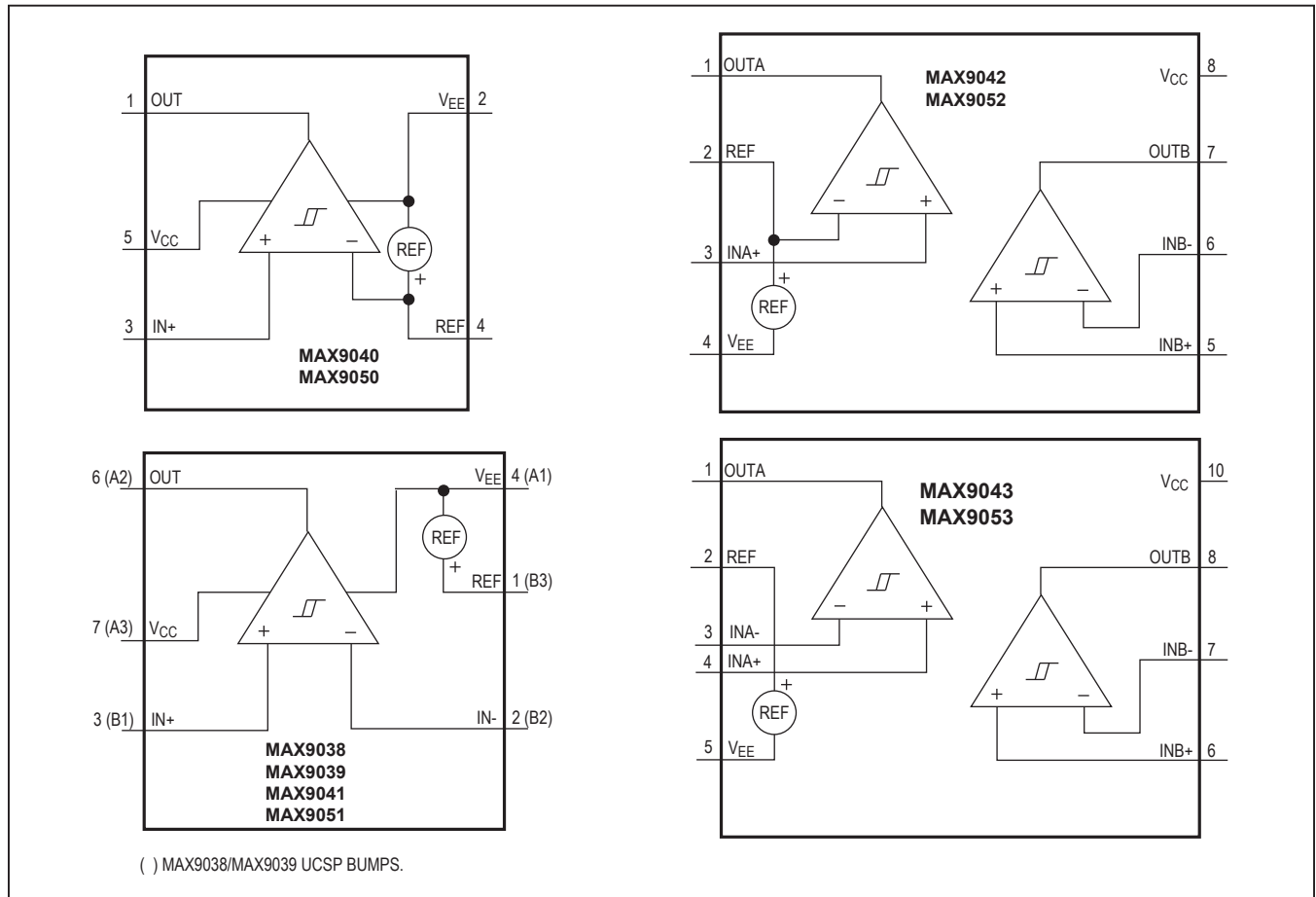

## Selector Guide

PART	COMPARATORS PER PACKAGE	VREF (V)	IN- CONNECTIONS
MAX9038	1	1.230	Uncommitted
MAX9039	1	1.230	Uncommitted
MAX9040	1	2.048	REF
MAX9041	1	2.048	Uncommitted
MAX9050	1	2.500	REF
MAX9051	1	2.500	Uncommitted
MAX9042	2	2.048	REF/Uncommitted
MAX9043	2	2.048	Uncommitted/Uncommitted
MAX9052	2	2.500	REF/Uncommitted
MAX9053	2	2.500	Uncommitted/Uncommitted

# MAX9038–MAX9043/ MAX9050–MAX9053

Micropower, Single-Supply, UCSP/SOT23  
Comparator + Precision Reference ICs

## Pin Configurations (continued)

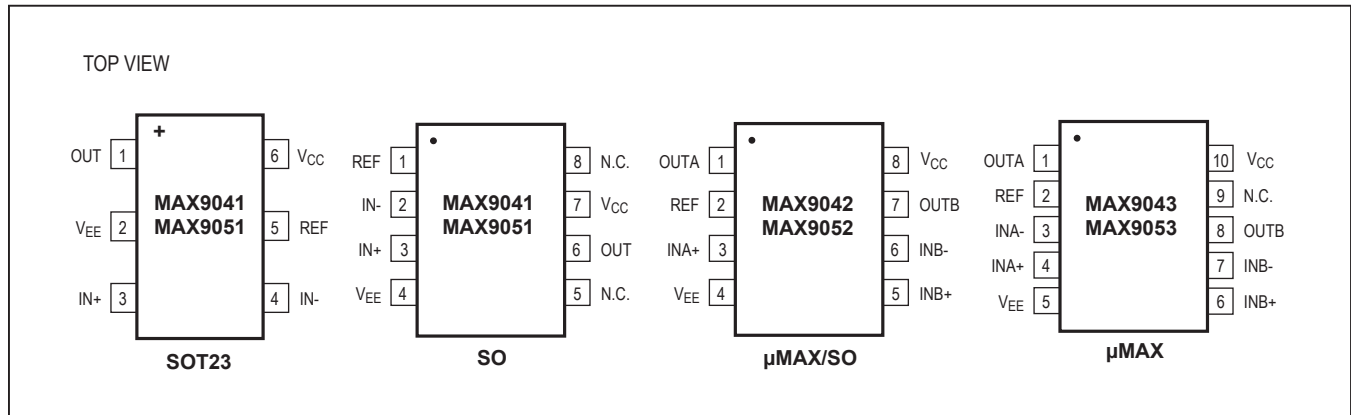

## Ordering Information (continued)

PART	TEMP RANGE	PIN-PACKAGE	TOP MARK
<b>MAX9042</b> AEUA	-40°C to +85°C	8 μMAX	—
MAX9042BEUA	-40°C to +85°C	8 μMAX	—
MAX9042AESA	-40°C to +85°C	8 SO	—
MAX9042BESA	-40°C to +85°C	8 SO	—
<b>MAX9043</b> AEUB	-40°C to +85°C	10 μMAX	—
MAX9043BEUB	-40°C to +85°C	10 μMAX	—
<b>MAX9050</b> AEUK+T	-40°C to +85°C	5 SOT23	ADNW
MAX9050BEUK+T	-40°C to +85°C	5 SOT23	ADNY
<b>MAX9051</b> AEUT+T	-40°C to +85°C	6 SOT23	AAHG
MAX9051BEUT+T	-40°C to +85°C	6 SOT23	AAHI
MAX9051AESA	-40°C to +85°C	8 SO	—
MAX9051BESA	-40°C to +85°C	8 SO	—
<b>MAX9052</b> AEUA	-40°C to +85°C	8 μMAX	AAHG
MAX9052BEUA	-40°C to +85°C	8 μMAX	AAHI
MAX9052AESA	-40°C to +85°C	8 SO	—
MAX9052BESA	-40°C to +85°C	8 SO	—
<b>MAX9053</b> AEUB	-40°C to +85°C	10 μMAX	—
MAX9053BEUB	-40°C to +85°C	10 μMAX	—

+Denotes lead(Pb)-free/RoHS-compliant package.

## Typical Operating Circuit

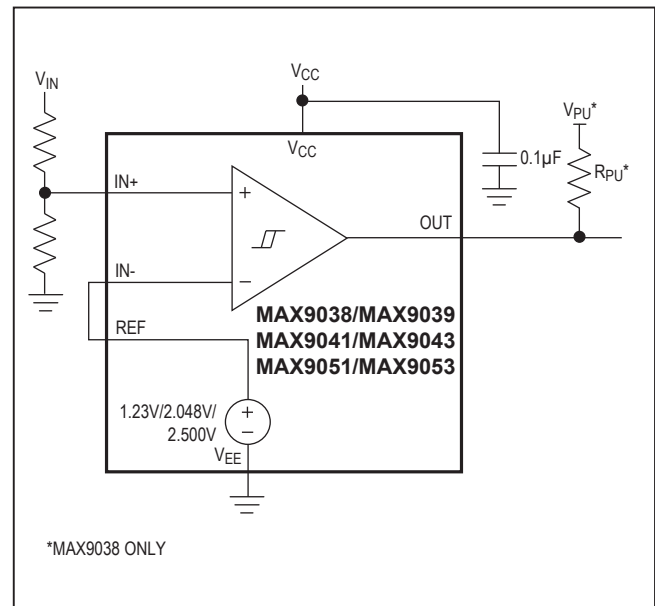

## Chip Information

PROCESS: CMOS

## MAX9038–MAX9043/ MAX9050–MAX9053

Micropower, Single-Supply, UCSP/SOT23  
Comparator + Precision Reference ICs

### Package Information

For the latest package outline information and land patterns (footprints), go to [www.maximintegrated.com/packages](http://www.maximintegrated.com/packages). Note that a "+", "#", or "-" in the package code indicates RoHS status only. Package drawings may show a different suffix character, but the drawing pertains to the package regardless of RoHS status.

PACKAGE TYPE	PACKAGE CODE	OUTLINE NO.	LAND PATTERN NO.
6 UCSP	B6-3	<a href="#">21-0097</a>	—
5 SOT23	—	<a href="#">21-0057</a>	<a href="#">90-0174</a>
6 SOT23	—	<a href="#">21-0058</a>	<a href="#">90-0175</a>
8 SO	—	<a href="#">21-0041</a>	<a href="#">90-0096</a>
8 FMAX	—	<a href="#">21-0036</a>	<a href="#">90-0092</a>
10 FMAX	—	<a href="#">21-0061</a>	<a href="#">90-0330</a>