

Click [here](#) to ask an associate for production status of specific part numbers.

Ultra-Small, nanoPower Single Comparators in 4-Bump UCSP and 5 SOT23

MAX9060–MAX9064

General Description

The MAX9060–MAX9064 are small single comparators, ideal for a wide variety of portable electronics applications such as cell phones, media players, and notebooks that have extremely tight board space and power constraints. These comparators are offered in both, a miniature 4-bump UCSP™ package with a 1mm x 1mm footprint (as small as two 0402 resistors), and a 5-pin SOT23 package.

The MAX9060–MAX9064 feature an input voltage range of -0.3V to +5.5V independent of supply voltage. These devices maintain high impedance at the inputs even when powered down (V_{CC} or $V_{REF} = 0V$). They also feature internal filtering to provide high RF immunity.

The MAX9060 and MAX9061 have open-drain outputs and draw quiescent supply current from a user-supplied reference voltage, V_{REF} , between 0.9V and 5.5V. These devices consume only 100nA (max) supply current and operate over the extended -40°C to +85°C temperature range.

The MAX9062, MAX9063 and MAX9064 are single comparators with an internal 0.2V reference. These devices feature either a push-pull or an open-drain output. They consume only 700nA (max) supply current. The MAX9062, MAX9063, and MAX9064 operate down to $V_{CC} = 1V$ over the extended -40°C to +85°C temperature range.

Applications

- Cell Phones
- Portable Media Players
- Electronic Toys
- Notebook Computers
- Portable Medical Devices

[Selector Guide and Typical Operating Circuits](#) appears at end of data sheet.

Pin Configurations

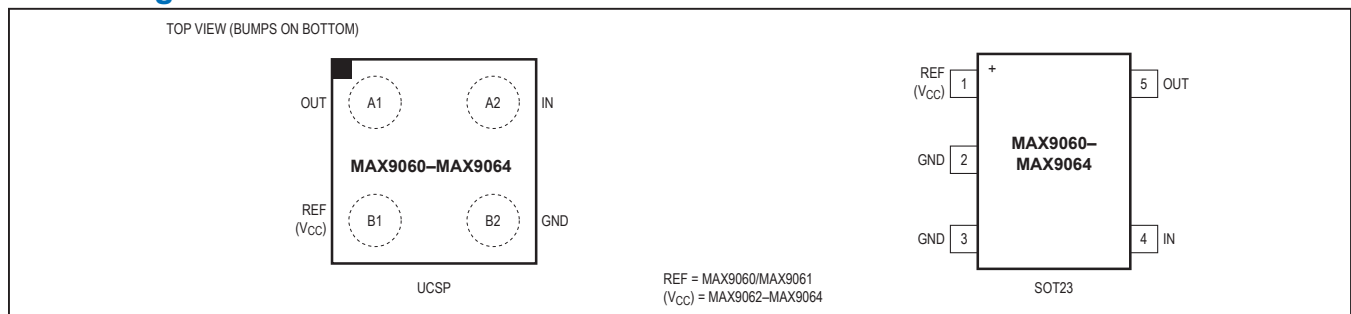

Features

- Tiny 1mm x 1mm x 0.6mm 4-Bump UCSP
- Footprint = Two 0402 Resistors
- Also Available in a 5-Pin SOT23 Package
- Ultra-Low Operating Current (100nA max)
- Input Voltage Range = -0.3V to +5.5V
- External REF Range = 0.9V to 5.5V (MAX9060/MAX9061)
- Internal REF Voltage = 0.2V (MAX9062/MAX9063/MAX9064)
- 15 μ s Propagation Delay
- -40°C to +85°C Extended Temperature Range

Ordering Information

| PART | PIN PACKAGE | TOP MARK |
|----------------|-------------|----------|
| MAX9060EBS+G45 | 4 UCSP | AFX |
| MAX9060EUK+ | 5 SOT23 | AFFG |
| MAX9061EBS+G45 | 4 UCSP | AFY |
| MAX9061EUK+ | 5 SOT23 | AFFH |
| MAX9062EBS+G45 | 4 UCSP | AFZ |
| MAX9062EUK+ | 5 SOT23 | AFFI |
| MAX9063EBS+G45 | 4 UCSP | AFA |
| MAX9063EUK+ | 5 SOT23 | AFFJ |
| MAX9063EUK/V+T | 5 SOT23 | +AMGH |
| MAX9064EBS+G45 | 4 UCSP | AFB |
| MAX9064EUK+ | 5 SOT23 | AFFK |

Note: All devices are specified over the extended -40°C to +85°C operating temperature range.

+Denotes a lead(Pb)-free/RoHS-compliant package.

V denotes an automotive qualified device.

T = Tape and reel.

G45 = Protective die coating.

UCSP is a trademark of Maxim Integrated Products, Inc.

Absolute Maximum Ratings

| | | | |
|--|-------------------------------------|--|-----------------|
| V _{CC} , REF, IN to GND..... | -0.3V to +6V | Operating Temperature Range..... | -40°C to +85°C |
| OUT to GND (MAX9060–MAX9063)..... | -0.3V to +6V | Junction Temperature..... | +150°C |
| OUT to GND (MAX9064 Only)..... | -0.3V to + (V _{CC} + 0.3V) | Storage Temperature Range..... | -65°C to +150°C |
| Output Short-Circuit Current Duration..... | 10s | Lead Temperature (excluding UCSP, soldering, 10s)..... | +300°C |
| Input Current into Any Terminal..... | ±20mA | Soldering Temperature (reflow)..... | +260°C |
| Continuous Power Dissipation | | | |
| 4-Bump UCSP (derate 3.0mW/°C above +70°C)..... | 238mW | | |
| 5-Pin SOT23 (derate 3.9mW/°C above +70°C)..... | 312mW | | |

Stresses beyond those listed under "Absolute Maximum Ratings" may cause permanent damage to the device. These are stress ratings only, and functional operation of the device at these or any other conditions beyond those indicated in the operational sections of the specifications is not implied. Exposure to absolute maximum rating conditions for extended periods may affect device reliability.

MAX9060/MAX9061 Electrical Characteristics

(V_{REF} = 1.8V, R_{PULLUP} = 10kΩ to V_{PULLUP} = 3.3V, T_A = -40°C to +85°C. Typical values are at T_A = +25°C, unless otherwise noted.) (Note 1)

| PARAMETER | SYMBOL | CONDITIONS | MIN | TYP | MAX | UNITS |
|-------------------------------------|--------------------------|--|------|------|------|-------|
| DC CHARACTERISTICS | | | | | | |
| Input Offset Voltage (Note 2) | V _{OS} | T _A = +25°C | | 1.3 | 6 | mV |
| | | | | | 9 | |
| Hysteresis | V _{HYS} | (Note 3) | | ±12 | | mV |
| Input Voltage Range | V _{IN} | | -0.3 | | +5.5 | V |
| Input Bias Current | I _{IN} | 0V < V _{IN} < V _{REF} + 0.6V | | | 40 | nA |
| | | V _{REF} + 0.6V < V _{IN} < 5.5V | | 10 | 100 | |
| Input Shutdown Current | I _{IN_PD} | V _{REF} = 0V, V _{IN} = 5.5V (Note 4) | | <0.1 | 27 | nA |
| Output Voltage Low | V _{OL} | I _{SINK} = 25μA, V _{REF} = 0.9V, T _A = +25°C | | 0.04 | 0.20 | V |
| | | I _{SINK} = 200μA, V _{REF} = 1.2V | | 0.08 | 0.20 | |
| | | I _{SINK} = 500μA, V _{REF} = 1.8V | | 0.13 | 0.23 | |
| | | I _{SINK} = 1.2mA, V _{REF} = 5.5V | | 0.19 | 0.50 | |
| Output Leakage Current (OUT = High) | I _{OUT_LEAKAGE} | V _{PULLUP} = 5.5V (Note 4) | | <0.1 | 35 | nA |
| AC CHARACTERISTICS | | | | | | |
| Propagation Delay | t _{PD} | Overdrive = ±100mV (Note 5) | | 25 | | μs |
| Fall Time | t _F | C _L = 10pF | | 14 | | ns |
| REF SUPPLY | | | | | | |
| REF Voltage | V _{REF} | Guaranteed by V _{OS} tests | 0.9 | | 5.5 | V |
| REF Input Current | I _{REF} | V _{REF} = 0.9V, V _{IN} = V _{REF} , T _A = +25°C | | 50 | | nA |
| | | V _{REF} = 1.8V, V _{IN} = V _{REF} , T _A = +25°C | | 60 | | |
| | | V _{REF} = 5.5V, V _{IN} = V _{REF} , T _A = +25°C | | 170 | 320 | |
| | | V _{REF} = 5.5V, V _{IN} = V _{REF} , -40°C < T _A < +85°C | | | 350 | |
| REF Rejection Ratio | RRR | V _{REF} = 0.9V to 5.5V, T _A = +25°C | 63 | 90 | | dB |
| Power-Up Time | t _{ON} | | | 3 | | ms |

MAX9062/MAX9063/MAX9064 Electrical Characteristics

(V_{CC} = 3.3V, R_{PULLUP} = 10kΩ to V_{PULLUP} = 3.3V for MAX9062/MAX9063, T_A = -40°C to +85°C. Typical values at T_A = +25°C, unless otherwise noted.) (Note 1)

| PARAMETER | SYMBOL | CONDITIONS | MIN | TYP | MAX | UNITS |
|--|--------------------------|---|------|-------------------------|-------------------------|-------|
| DC CHARACTERISTICS | | | | | | |
| Input Voltage Range | V _{IN} | Guaranteed by I _{IN} test | -0.3 | | +5.5 | V |
| Input Bias Current | I _{IN} | V _{IN} = 0.2V to 5.5V (Note 4) | | 0.06 | 15 | nA |
| Input Leakage Current | I _{IN_SHDN} | V _{CC} = 0V, V _{IN} = 5.5V (Note 4) | | <0.1 | 15 | nA |
| Output Voltage Low | V _{OL} | I _{SINK} = 50μA, V _{CC} = 1.0V | | 0.03 | 0.2 | V |
| | | I _{SINK} = 200μA, V _{CC} = 1.2V | | 0.08 | 0.20 | |
| | | I _{SINK} = 500μA, V _{CC} = 1.8V | | 0.13 | 0.23 | |
| | | I _{SINK} = 0.75mA, V _{CC} = 3.3V | | 0.14 | 0.3 | |
| | | I _{SINK} = 1.2mA, V _{CC} = 5.5V | | 0.19 | 0.5 | |
| Output Voltage High (MAX9064 Only) | V _{OH} | I _{SOURCE} = 15μA, V _{CC} = 1.0V | | V _{CC} - 0.08V | V _{CC} - 0.02V | V |
| | | I _{SOURCE} = 40μA, V _{CC} = 1.2V | | V _{CC} - 0.08V | V _{CC} - 0.20V | |
| | | I _{SOURCE} = 180μA, V _{CC} = 1.8V | | V _{CC} - 0.15V | V _{CC} - 0.23V | |
| | | I _{SOURCE} = 0.3mA, V _{CC} = 3.3V | | V _{CC} - 0.13V | V _{CC} - 0.3V | |
| | | I _{SOURCE} = 0.75mA, V _{CC} = 5.5V | | V _{CC} - 0.24V | V _{CC} - 0.5V | |
| Output Leakage Current (MAX9062/MAX9063 Only) | I _{OUT_LEAKAGE} | OUT = high, V _{PULLUP} = 5.5V (Note 4) | | <0.1 | 15 | nA |
| AC CHARACTERISTICS | | | | | | |
| Propagation Delay | t _{PD} | V _{OVERDRIVE} = ±100mV (Note 5) | | 15 | | μs |
| Fall Time | t _F | C _L = 10pF | | 14 | | ns |
| Rise Time | t _R | C _L = 10pF, MAX9064 only | | 30 | | ns |
| REFERENCE VOLTAGE | | | | | | |
| Input Threshold (Note 6) | V _{REF} | T _A = +25°C | 188 | 200 | 212 | mV |
| | | T _A = -40°C to +85°C | 185 | 200 | 215 | |
| Input Threshold Hysteresis | V _{HYS} | T _A = -40°C to +85°C (Note 3) | | ±0.9 | | mV |
| REF Tempco | V _{REF_TEMP} | (Note 7) | | 6 | | μV/°C |
| Power-Supply Rejection Ratio | PSRR | V _{CC} = 1.0V to 5.5V | 40 | 53 | | dB |
| POWER SUPPLY | | | | | | |
| Supply Voltage | V _{CC} | Guaranteed by V _{OL} /V _{OH} tests | 1.0 | | 5.5 | V |
| Supply Current | I _{CC} | V _{CC} = 1.0V | | 0.4 | 0.7 | μA |
| | | V _{CC} = 5.5V | | 0.6 | 1.1 | |
| Power-Up Time | t _{ON} | | | 3 | | ms |

Note 1: All devices are 100% production tested at T_A = +25°C. Temperature limits are guaranteed by design.

Note 2: Guaranteed by ATE and/or bench characterization over temperature. V_{OS} is the average of the trip points minus V_{REF}.

Note 3: Hysteresis is half the input voltage difference between the two switching points.

Note 4: Too small to be measured in an ATE test environment. Only gross test to catch failures is implemented.

Note 5: Overdrive is defined as the voltage above or below the switching points.

Note 6: Guaranteed by ATE and/or bench characterization over temperature. V_{REF} is the average of the trip points.

Note 7: Includes reference error along with comparator offset voltage error.

Typical Operating Characteristics

($V_{CC} = 3.3V$, $V_{REF} = 1.8V$, $R_{PULLUP} = 10k\Omega$ to $V_{PULLUP} = 3.3V$ for MAX9060–MAX9063, $V_{GND} = 0V$, $T_A = +25^\circ C$, unless otherwise noted.)

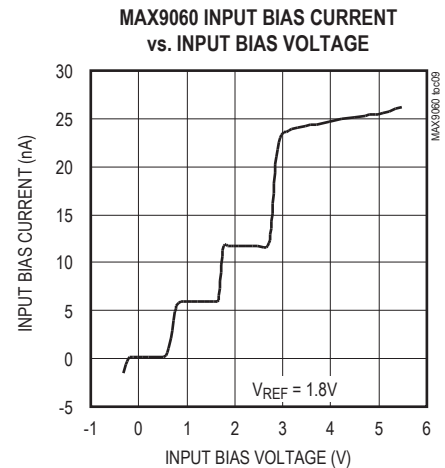
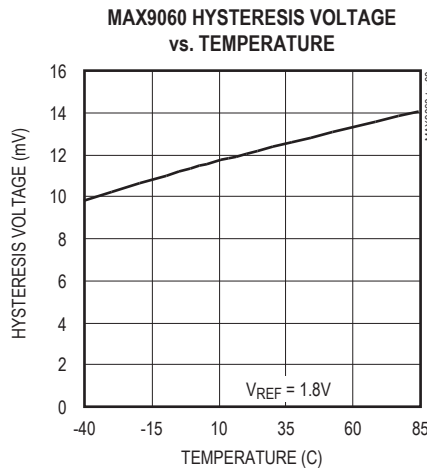
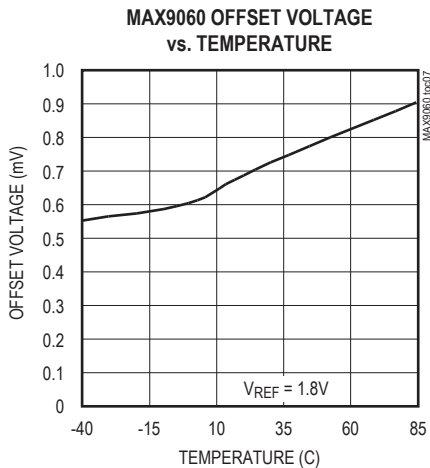
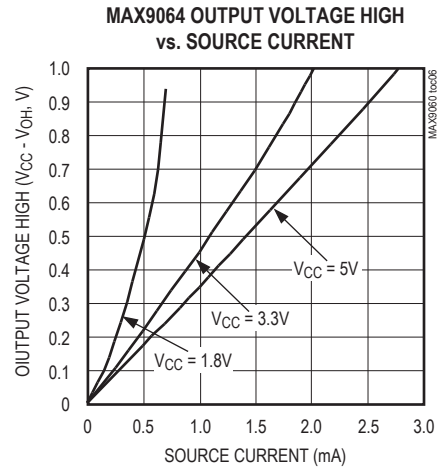
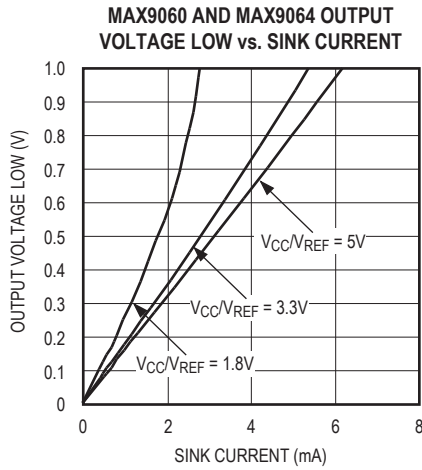
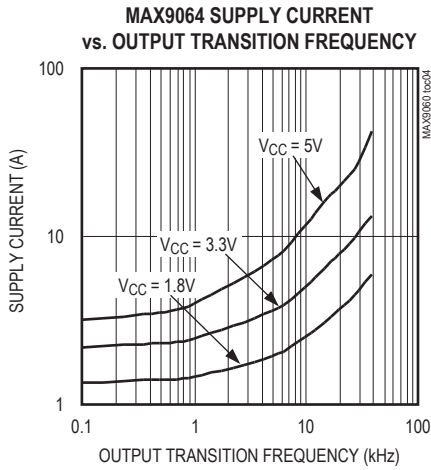
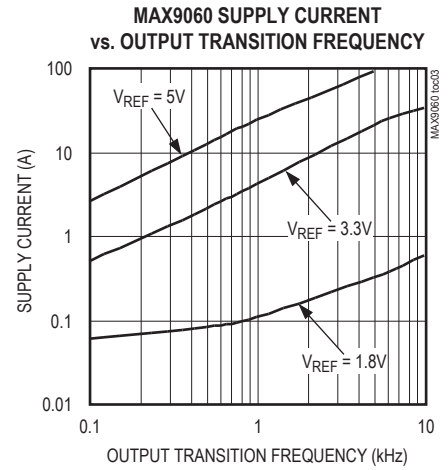
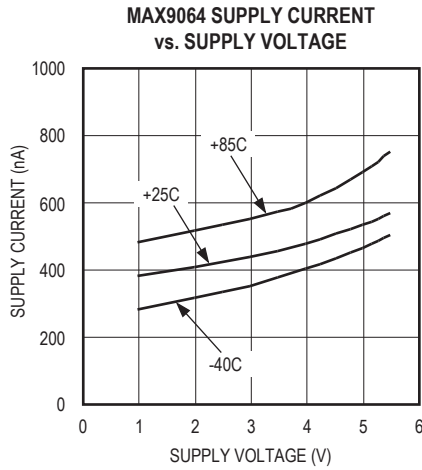
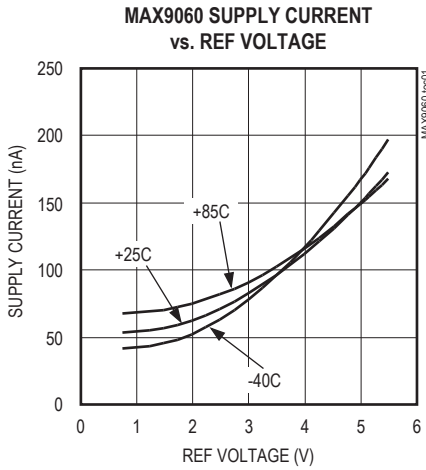

Typical Operating Characteristics (continued)

($V_{CC} = 3.3V$, $V_{REF} = 1.8V$, $R_{PULLUP} = 10k\Omega$ to $V_{PULLUP} = 3.3V$ for MAX9060–MAX9063, $V_{GND} = 0V$, $T_A = +25^\circ C$, unless otherwise noted.)

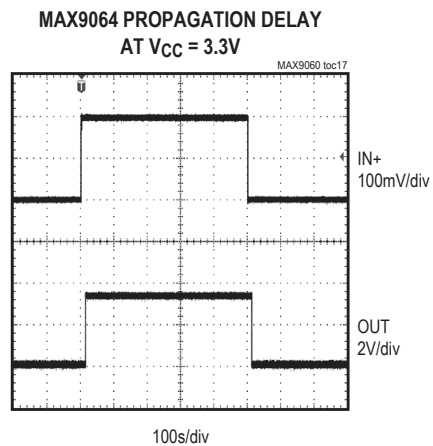
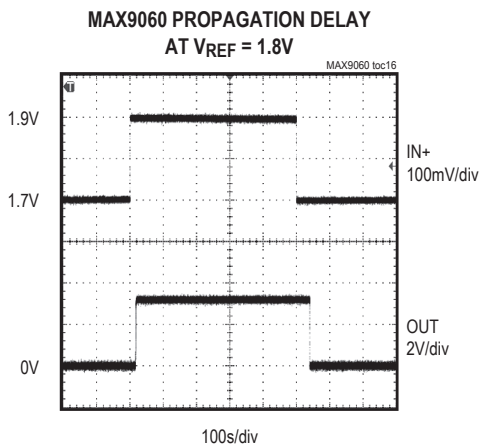
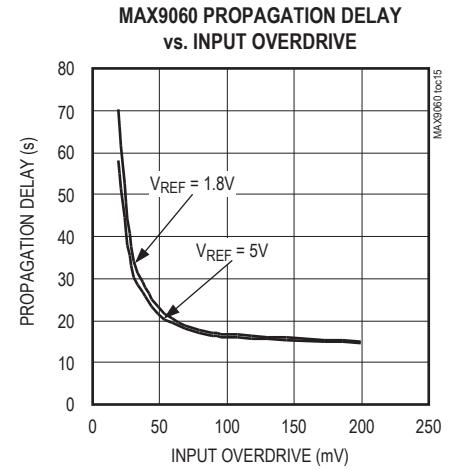
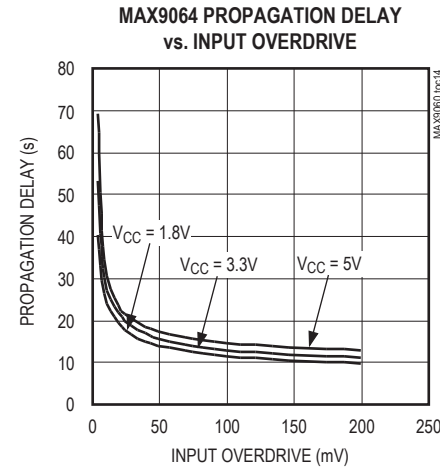
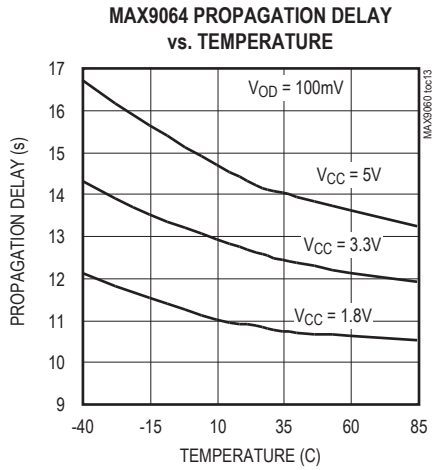
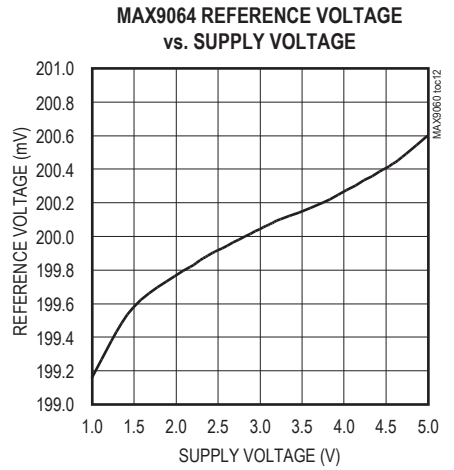
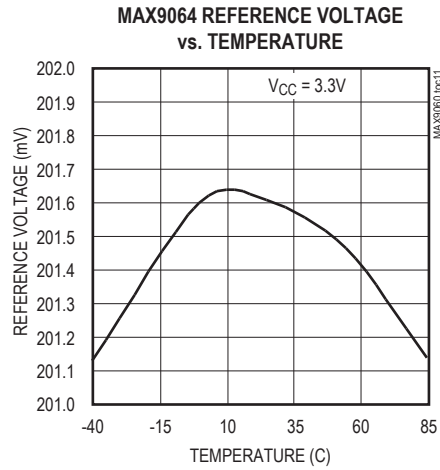
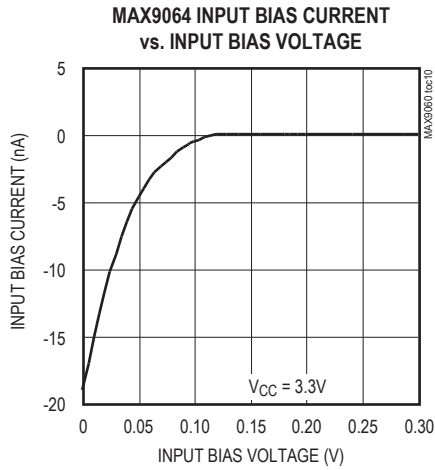

Typical Operating Characteristics (continued)

($V_{CC} = 3.3V$, $V_{REF} = 1.8V$, $R_{PULLUP} = 10k\Omega$ to $V_{PULLUP} = 3.3V$ for MAX9060–MAX9063, $V_{GND} = 0V$, $T_A = +25^\circ C$, unless otherwise noted.)

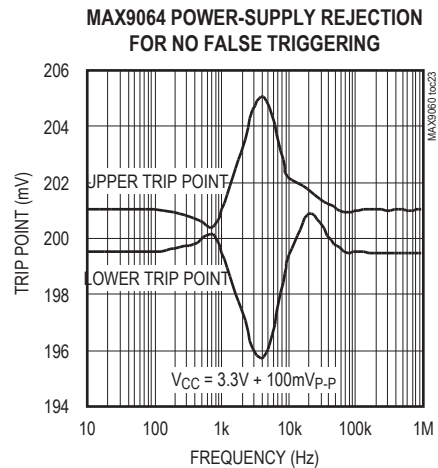
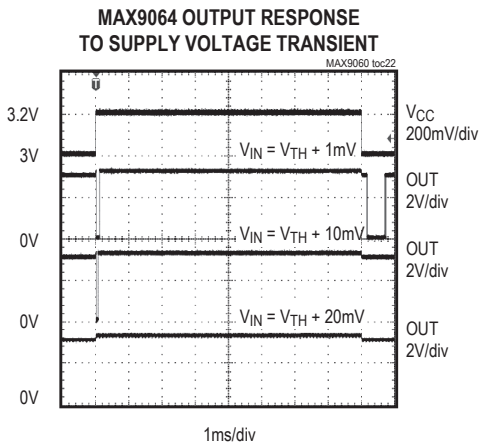
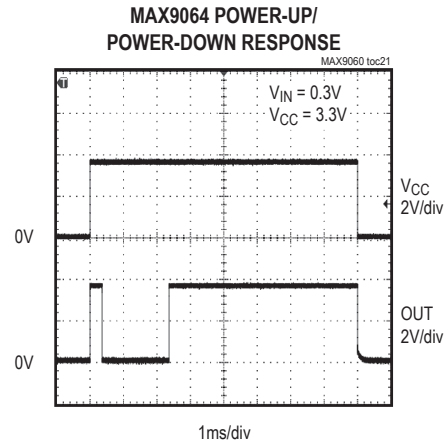
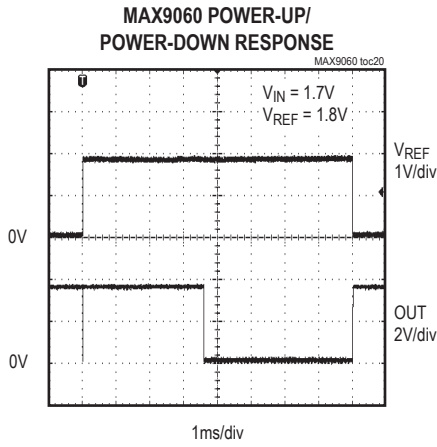
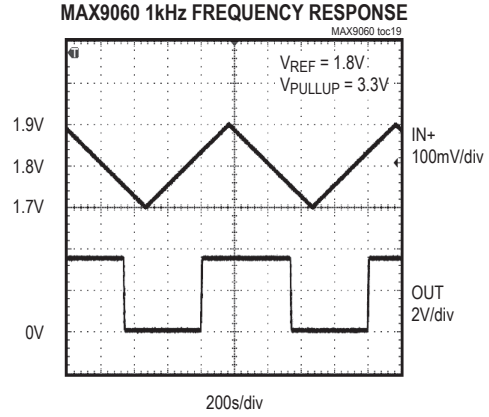
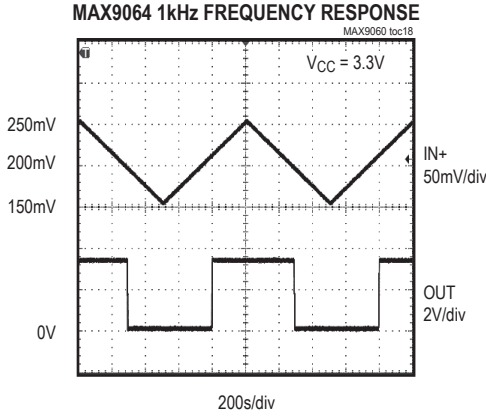

Pin/Bump Description

| BUMP | | PIN | | NAME | FUNCTION |
|--------------------|-------------------------------|--------------------|-------------------------------|-----------------|--|
| UCSP | | SOT23 | | | |
| MAX9060 MAX9061 | MAX9062 MAX9063 MAX9064 | MAX9060 MAX9061 | MAX9062 MAX9063 MAX9064 | | |
| A1 | A1 | 5 | 5 | OUT | Comparator Output. The MAX9060–MAX9063 have open-drain outputs. The MAX9064 has a push-pul output. |
| A2 | A2 | 4 | 4 | IN | Comparator Input. The MAX9060, MAX9062, and MAX9064 have noninverting inputs. The MAX9061 and MAX9063 have inverting inputs. |
| — | B1 | — | 1 | V _{CC} | Power-Supply Voltage. Bypass to ground with a 0.1µF bypass capacitor. |
| B1 | — | 1 | — | REF | External Reference Input. REF also supplies power to the device. Bypass to ground with a 0.1µF bypass capacitor. |
| B2 | B2 | 2, 3 | 2, 3 | GND | GROUND. |

Detailed Description

The MAX9060–MAX9064 are extremely small comparators ideal for compact, low-current, and low-voltage applications.

The MAX9060/MAX9061 consume only 50nA (typ) operating current, while the MAX9062/MAX9063/MAX9064 consume only 400nA (typ). The low-voltage operating capability of the MAX9060–MAX9064 makes these devices extremely attractive to long-life battery-operated devices—these applications can now use a single digital power-supply rail to power the new generation of microcontrollers (which can be down to 0.9V). A single AA/AAA cell can drop down to 0.9V in full discharge. All parts are available in a tiny 4-bump UCSP, that is only 0.6mm tall, and occupies a 1mm x 1mm footprint and a 5-pin SOT23.

Input Stage Circuitry

Noninverting inputs are available on the MAX9060/MAX9062/MAX9064 and inverting inputs are available on the MAX9061/MAX9063.

The MAX9060–MAX9064 incorporate an innovative input stage architecture that allows their input voltage to exceed V_{CC} by several volts (limited only by the

Absolute Maximum Ratings). This is unlike traditional comparators that have an input ESD diode clamp between the input and V_{CC}, limiting this maximum over-voltage to about 0.3V. The MAX9060–MAX9064 architecture maintains a high input impedance to input signals even when the device power-supply voltage is completely turned off (V_{CC} or REF taken to 0V). This greatly benefits flexible power-saving schemes to be easily implemented in advanced battery-operated devices. On-chip filtering provides immunity from any RF noise being picked up by input traces. These devices feature an internal temperature-compensated, low-power 0.2V reference voltage.

Output Stage Structure

The MAX9060–MAX9063 have open-drain outputs that allow them to interface to logic circuitry running from supply voltages other than the one supplied to the part. These devices require an external pullup resistor or current source for proper operation. Many microcontroller digital inputs ports can be readily programmed to include these.

The MAX9064 has a push-pull output stage that can both sink and source current, eliminating the need for an external pullup resistor. In this case, the MAX9064 uses the microcontroller's power supply as V_{CC}.

Table 1. How Devices Behave Under Various Input Voltage Conditions

| PART | INPUT VOLTAGE CONDITIONS | ACTION AT OUTPUT |
|---------|--------------------------|---|
| MAX9060 | $V_{IN} > V_{REF}$ | External pullup resistor pulls output high. |
| | $V_{IN} < V_{REF}$ | Output asserts low. |
| MAX9061 | $V_{IN} > V_{REF}$ | Output asserts low. |
| | $V_{IN} < V_{REF}$ | External pullup resistor pulls output high. |
| MAX9062 | $V_{IN} > 0.2V$ | External pullup resistor pulls output high. |
| | $V_{IN} < 0.2V$ | Output asserts low. |
| MAX9063 | $V_{IN} > 0.2V$ | Output asserts low. |
| | $V_{IN} < 0.2V$ | External pullup resistor pulls output high. |
| MAX9064 | $V_{IN} > 0.2V$ | Output asserts high. |
| | $V_{IN} < 0.2V$ | Output asserts low. |

Applications Information

Bypassing REF/VCC

Place a 0.1µF capacitor between REF or VCC and GND as close as possible to the device. During a switching event, all comparators draw a current spike from their power-supply rails. This current spike is minimized by the use of an internal break-before-make design.

Hysteresis Operation

The MAX9060–MAX9064 feature internal hysteresis for noise immunity and glitch-free operation. If additional hysteresis is needed, an external positive feedback network can be easily implemented on the MAX9060, MAX9062,

and MAX9064 noninverting input devices. Additional external hysteresis is not recommended for the MAX9061 due to possible crossover current-related noise problems. Additional external hysteresis is not possible on the MAX9063 because the noninverting input of the comparator is not externally accessible.

Adaptive Signal Level Detector

The MAX9060 and MAX9061 can be used as an adaptive signal-level detector. Feed a DAC output voltage to REF and connect the input to a variable signal level. As the DAC output voltage is varied from 0.9V to 5.5V, a corresponding signal level threshold-detector circuit is implemented. See [Figure 1](#).

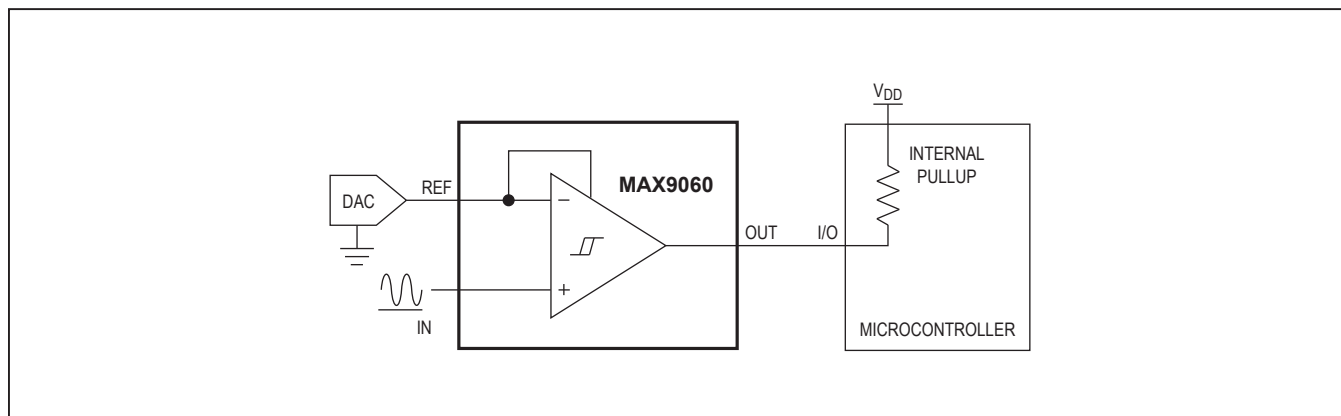
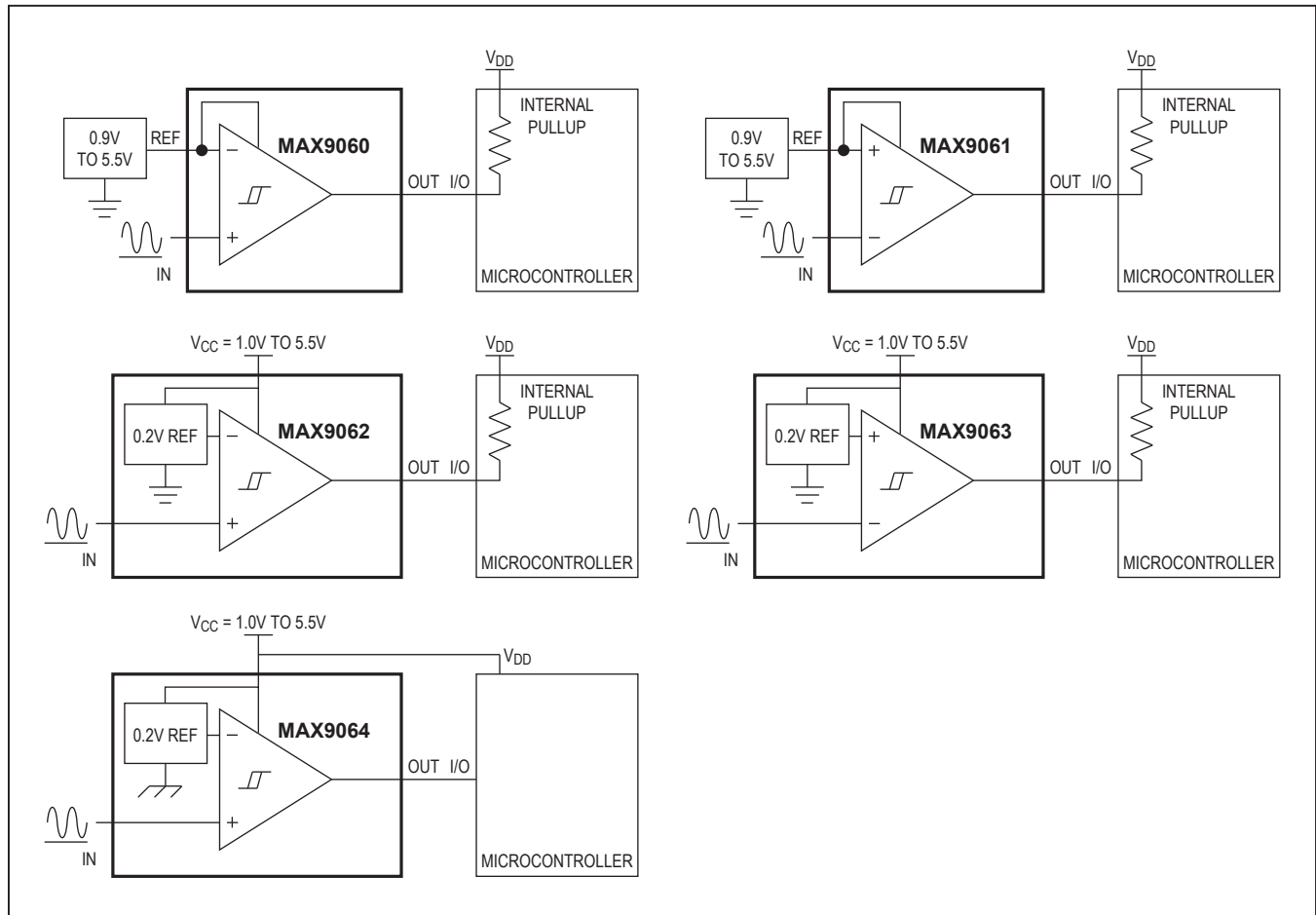

Figure 1. Adaptive Signal Level Detector

Typical Operating Circuits



Selector Guide

| PART | REFERENCE VOLTAGE | INPUT | OUTPUT |
|---------|-------------------|--------------|------------|
| MAX9060 | External | Noninverting | Open drain |
| MAX9061 | External | Inverting | Open drain |
| MAX9062 | 0.2V | Noninverting | Open drain |
| MAX9063 | 0.2V | Inverting | Open drain |
| MAX9064 | 0.2V | Noninverting | Push-pull |

Package Information

For the latest package outline information and land patterns (footprints), go to www.maximintegrated.com/packages. Note that a “+”, “#”, or “-” in the package code indicates RoHS status only. Package drawings may show a different suffix character, but the drawing pertains to the package regardless of RoHS status.

| PACKAGE TYPE | PACKAGE CODE | OUTLINE NO. | LAND PATTERN NO. |
|--------------|--------------|-------------------------|-------------------------|
| 5 SOT23 | U5+2 | 21-0057 | 90-0174 |
| 4 UCSP | B4+1 | 21-0789 | — |

Chip Information

PROCESS: BiCMOS

Package Information (continued)

For the latest package outline information and land patterns (footprints), go to www.maximintegrated.com/packages. Note that a “+”, “#”, or “-” in the package code indicates RoHS status only. Package drawings may show a different suffix character, but the drawing pertains to the package regardless of RoHS status.

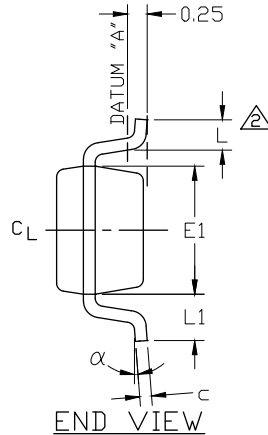
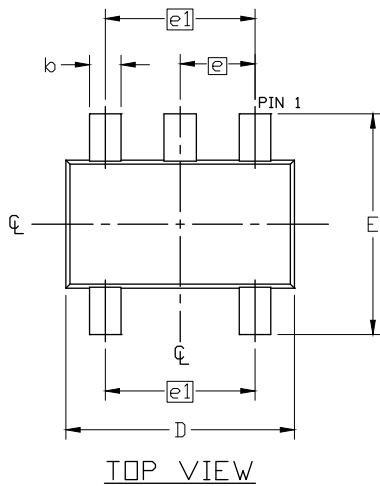

| SYMBOL | MIN | NOM | MAX |
|----------|-----------|-------|------|
| A | 0.90 | 1.25 | 1.45 |
| A1 | 0.00 | 0.05 | 0.15 |
| A2 | 0.90 | 1.10 | 1.30 |
| b | 0.35 | 0.40 | 0.50 |
| c | 0.08 | 0.15 | 0.20 |
| D | 2.80 | 2.90 | 3.00 |
| E | 2.60 | 2.80 | 3.00 |
| E1 | 1.50 | 1.625 | 1.75 |
| L | 0.35 | 0.45 | 0.60 |
| L1 | 0.60 REF | | |
| e | 0.95 BSC. | | |
| e1 | 1.90 BSC. | | |
| α | 0° | 2.5° | 8° |

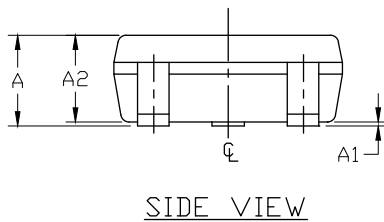

NOTES:

1. ALL DIMENSIONS ARE IN MILLIMETERS UNLESS OTHERWISE SPECIFIED.
2. FOOT LENGTH MEASURED AT INTERCEPT POINT BETWEEN DATUM A & LEAD SURFACE.
3. PACKAGE OUTLINE EXCLUSIVE OF MOLD FLASH & METAL BURR. MOLD FLASH, PROTRUSION OR METAL BURR SHOULD NOT EXCEED 0.25 MM.
4. MEETS JEDEC MO178, VARIATION AA.
5. LEADS TO BE COPLANAR WITHIN 0.10 mm.
6. SOLDER THICKNESS MEASURED AT FLAT SECTION OF LEAD BETWEEN 0.08mm AND 0.15mm FROM LEAD TIP.
7. MATERIAL MUST BE COMPLIANT WITH MAXIM SPECIFICATION 10-0131 FOR SUBSTANCE CONTENT, MUST BE Eu ROHS COMPLIANT WITHOUT EXEMPTION AND PB-FREE.
8. ALL DIMENSIONS APPLY TO BOTH LEADED (-) AND LEAD FREE (+) PACKAGE CODES.
9. PKG CODES: U5-1, U5-1A, U5-2, U5-2A

-DRAWING NOT TO SCALE-



TITLE:
PACKAGE OUTLINE,
5L SOT23

| | | |
|----------|---------------------------------|------------|
| APPROVAL | DOCUMENT CONTROL NO. 21-0057 | REV. J 1/1 |
|----------|---------------------------------|------------|

Package Information (continued)

For the latest package outline information and land patterns (footprints), go to www.maximintegrated.com/packages. Note that a “+”, “#”, or “-” in the package code indicates RoHS status only. Package drawings may show a different suffix character, but the drawing pertains to the package regardless of RoHS status.

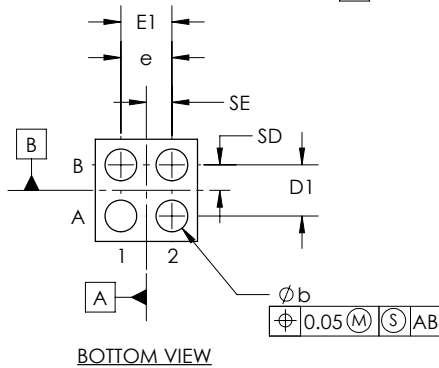
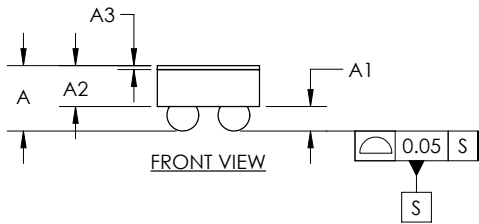
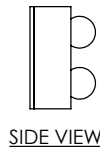
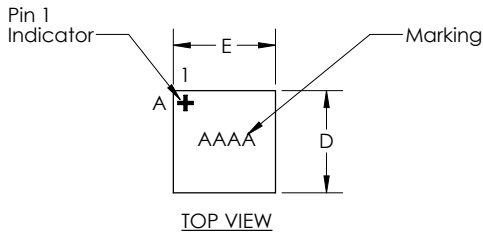

| COMMON DIMENSIONS | |
|----------------------------|-------------|
| A | 0.64 ±0.05 |
| A1 | 0.24 ±0.03 |
| A2 | 0.40 REF |
| A3 | 0.04 BASIC |
| b | ∅0.31 ±0.03 |
| D | 1.000 ±0.05 |
| E | 1.000 ±0.05 |
| D1 | 0.50 BASIC |
| E1 | 0.50 BASIC |
| e | 0.50 BASIC |
| SD | 0.25 BASIC |
| SE | 0.25 BASIC |
| DEPOPULATED BUMPS: NONE | |

- NOTES:
1. Terminal pitch is defined by terminal center to center value.
 2. Outer dimension is defined by center lines between scribe lines.
 3. All dimensions in millimeter.
 4. Marking shown is for package orientation reference only.
 5. Tolerance is ± 0.02 unless specified otherwise.
 6. All dimensions apply to PbFree (+) package codes only.

- DRAWING NOT TO SCALE -

| | | |
|--|---------------------------------|------------|
| | | |
| TITLE PACKAGE OUTLINE 4 BUMPS WLP PKG. 0.5 mm PITCH, B4+1 | | |
| APPROVAL | DOCUMENT CONTROL NO. 21-0789 | REV. B 1/1 |