

**General Description**

The MAX9288/MAX9290 evaluation kit (EV kit) provides a proven design to evaluate the MAX9288 and MAX9290 high-bandwidth gigabit multimedia serial link (GMSL) deserializers with spread spectrum and full-duplex control channel, with the use of a standard FAKRA coaxial cable. The EV kit also includes Windows Vista®, and Windows® 7-compatible software that provides a simple graphical user interface (GUI) for exercising features of the device. The EV kit comes with a MAX9288 or MAX9290 IC installed.

For complete GMSL evaluation, using a standard FAKRA coaxial cable, order the MAX9288/MAX9290 coax EV kit and a companion serializer board (e.g., the MAX9275/MAX9279 coax EV kit referenced in this document). For testing with STP cable, also order the MAXCOAX2STP-HSD adapter kit. Only one adapter kit is needed per pair of serializer and deserializer boards.

**Note:** In the following sections, the term serializer refers to the MAX9275 or MAX9279 ICs and the term deserializer refers to the MAX9288 or MAX9290 ICs. The term SerDes refers to serializer(s) and deserializer(s).

This document applies to both coax and STP EV kits. This document covers coax cables, but the information applies equally to STP cables.

Ordering Information appears at end of data sheet.

**Features**

- Drives 4-Channel CSI-2 Output
- Windows Vista- and Windows 7-Compatible Software
- USB-Controlled Interface (Cable Included)
- USB Powered
- Proven PCB Layout
- Fully Assembled and Tested

**MAX9288/MAX9290 EV Kit Files**

DESCRIPTION	DESCRIPTION
MAXSerDesEV-N_Vxxxx_Install.EXE	Installs the EV kit files in your computer
MAXSerDesEV-N.EXE	Graphical user interface (GUI) program

**Items Included in the EV Kit Package**

DESCRIPTION	QTY
MAX9288 coax EV kit board or MAX9290 coax EV kit board	1
2m FAKRA coax cable assembly	1
USB cable	1

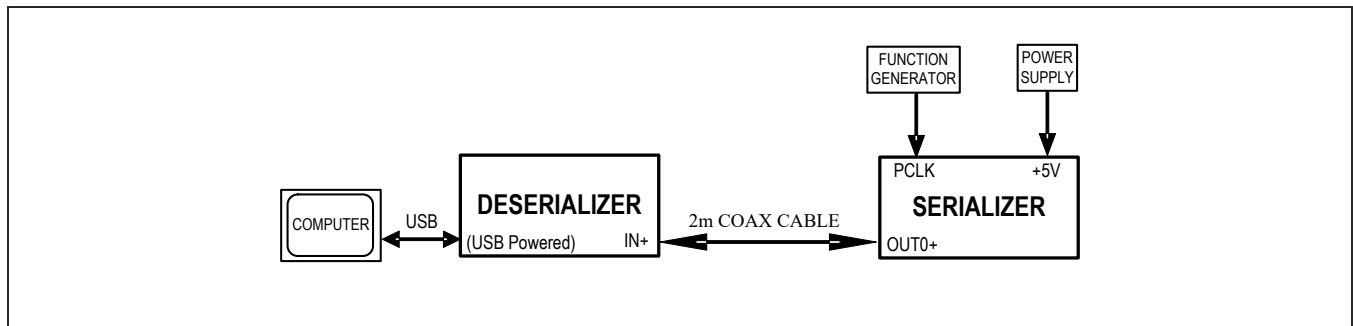

Figure 1. MAX9288/MAX9290 Evaluation Board Test Setup

Windows and Windows Vista are registered trademarks and registered service marks of Microsoft Corporation.

**Quick Start**

This procedure applies to both coax and STP evaluation kits. The coax evaluation kit is referenced here.

**Required Equipment**

- MAX9288/MAX9290 deserializer coax EV kit
- MAX9275/MAX9279 serializer coax EV kit
- 2m FAKRA cable assembly (included in the MAX9288/MAX9290 coax EV kit)
- > 20MHz function generator
- Windows Vista or Windows 7 PC with a spare USB port (direct 500mA connection required; do not use a bus-powered hub)
- 5V DC, 500mA power supply

**Note:** In the following sections, software-related items are identified by **bolding**. Text in **bold** refers to items directly from the EV kit software. Text in **bold and underlined** refers to items from the Windows operating system.

**Procedure**

The EV kit is fully assembled and tested. Follow the steps below to verify board operation:

- 1) Download and install the latest version of the EV kit software from [www.maximintegrated.com](http://www.maximintegrated.com).
  - a. Search for the MAX9288.
  - b. Select **MAX9288 | Design Resources | Software | MAXSerDes-N** and download the **MAXSerDes-Nxxxx\_Install.zip** file.
  - c. Open the downloaded zip file and run **MAXSerDes-Nxxxx\_Install.exe**.
  - d. The installation application downloads and installs the USB driver for the Nuvoton microcontroller. If the USB driver installation is not successful, install the appropriate USB driver for your computer, available at <http://www.ftdichip.com/Drivers/VCP.htm>.

- 2) Verify that jumpers on the deserializer board are in their default positions, as shown in [Figure 12](#).
- 3) Verify that jumpers on the serializer board are in their default positions, as shown in [Figure 13](#).
- 4) Set up the system, as shown in [Figure 1](#).
- 5) Power up the serializer board by connecting the power supply to the +5VIN/GND terminals on the serializer board.
- 6) Power up the deserializer board by connecting the USB cable between the PC's USB port and connector J10 on the deserializer board.
- 7) Connect the FAKRA cable from the OUT+ terminal on the serializer board to the IN+ terminal on the deserializer board.
- 8) Connect the pixel clock and function generator to the serializer EV kit board header's H1 PCLK\_IN pin.
- 9) Turn on the power supply and function generator.
- 10) Verify that LED\_PWR on the serializer EV kit board lights up, indicating that the board is powered.
- 11) Verify that the LOCK LED on the deserializer EV kit board illuminates, indicating that the link has been successfully established. If the LOCK LED is off or the ERR LED is on, consult the [Troubleshooting](#) section and fix the problem before continuing.
- 12) Start the EV kit software by selecting **Start | Programs | Maxim Integrated | MAXSerDesEV-N | MAXSerDesEV-N**
- 13) In case an operating evaluation board with a Nuvoton microcontroller is not found, a window opens, warning as such ([Figure 2](#)). Press **OK** to continue and start the GUI anyway or press **Cancel** to terminate the application. Consult the [Troubleshooting](#) section and fix the problem before continuing.
- 14) When an operating Nuvoton microcontroller is found, the GUI checks the firmware version in the microcontroller and prompts the user to update. Press **OK** to continue working, or press **Cancel** to stop the applications ([Figure 3](#)).

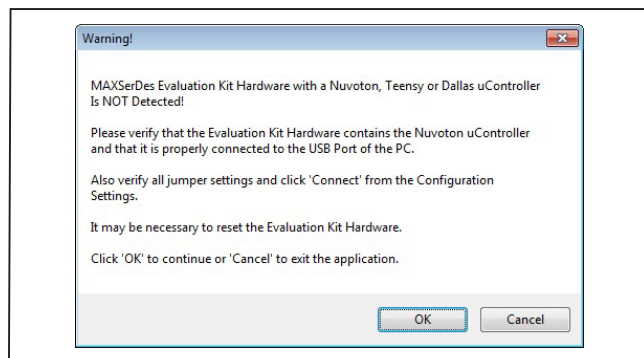

Figure 2. MAXSerDesEV-N EV Kit Software: Warning! (Nuvoton Microcontroller is Not Detected!)

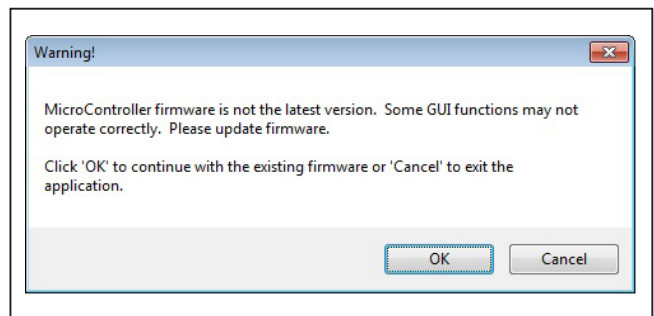

Figure 3. MAXSerDesEV-N EV Kit Software: Warning! (Microcontroller Firmware is Not the Latest Version)

- 15) The **Configuration Settings** window appears, as shown in [Figure 4](#). The GUI automatically scans all possible slave addresses and identifies the connected devices (DUTs) based on the **Device IDs** read from the DUTs' internal registers.
- 16) Once the **Configuration Settings** window is open, press the **Identify Devices** button to search for connected devices. Once the devices are identified, the corresponding configuration jumpers are displayed to help users configure the serializer and deserializer. Only **Link Type** and **Device Address** selections on **Configuration Setting** window affect the EV kit operation. Other items are for user reference only.
- 17) Press the **Connect** button to open the **Evaluation Kit** window and the DUTs' register maps ([Figure 5](#)). The GUI reads all the SerDes' internal registers and updates the corresponding tabs.
- 18) Press the **Read All MAX9279** button in the **Serializer** group box to read all serializer registers.
- 19) Press the **Deserializer** tab and then press **Read All MAX9290** in the **Deserializer** group box to read all deserializer registers.
- 20) Select any of the other tabs to evaluate other functions of the SerDes.

### Detailed Description of Software

To start the MAX9288/MAX9290 EV kit GUI, select **Start | Programs | Maxim Integrated | MAXSerDesEV-N | MAXSerDesEV-N**.

### Configuration Settings Window

The **Configuration Settings** window is the first window that opens after successful program launch. It allows the user to specify serializer and deserializer board setup and mode of operation ([Figure 4](#)).

### Controller Group Box

From the **Controller** group box, select **Coax** or **STP** from the **Link Type** drop-down list, **I2C** or **UART** from the **Bus** drop-down list, and click on either the **Serializer** or **Deserializer** radio button to determine which device should connect to the USB controller. Upon changing any of these parameters, the selection in the jumper listing highlights automatically, prompting the user to manually make the corresponding jumper-position changes on the EV kit boards.

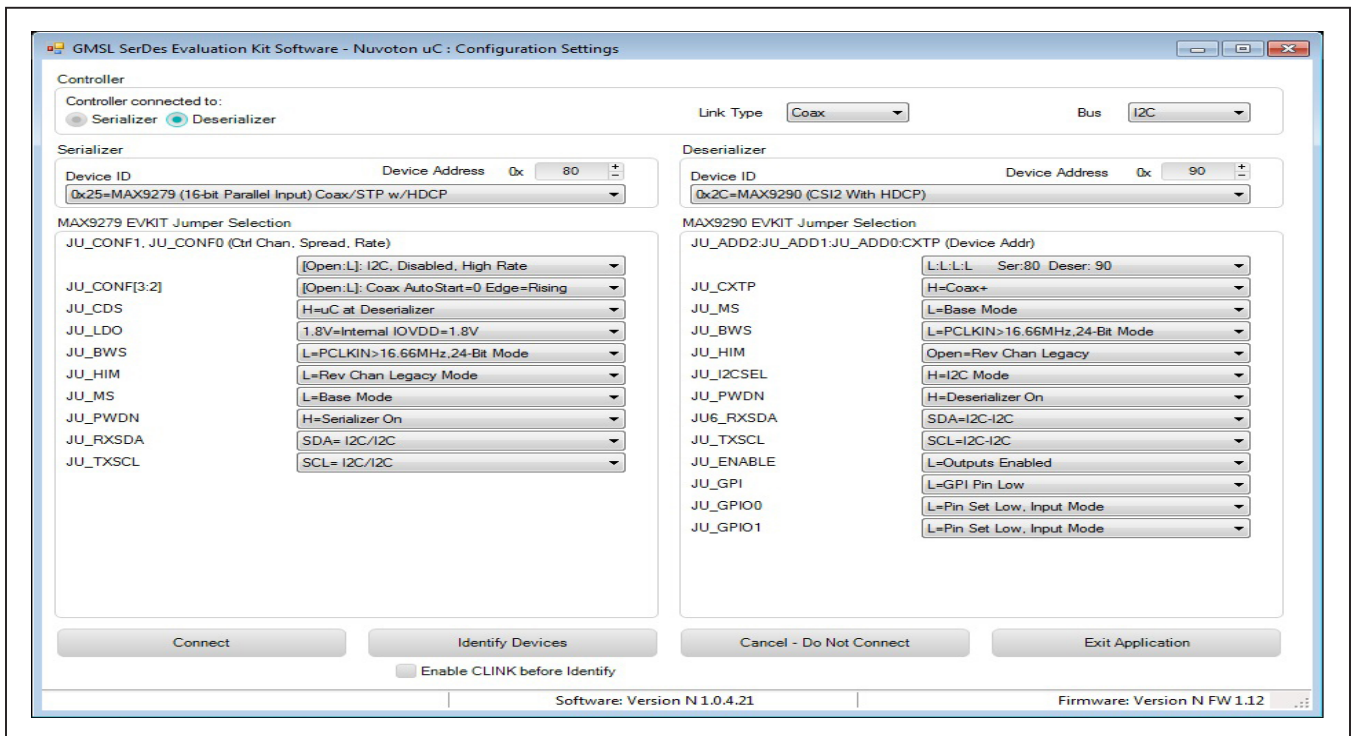

Figure 4. MAXSerDesEV-N EV Kit Software: Configuration Settings Window (Shown with MAX9279, MAX9290 EV Kits Connected)

### Serializer Jumper Selection Block

The **Serializer Jumper Selection** block lists the jumpers on the evaluation board of the selected **Device ID** and shows the correct shunt positions based on the conditions selected in the **Controller** block.

### Deserializer Jumper Selection Block

The **Deserializer Jumper Selection** block lists the jumpers on the evaluation board of the selected **Device ID** and shows the correct shunt positions based on the conditions selected in the **Controller** block.

[Figure 12](#) shows jumper setting on the MAX9288/MAX9290 PCB for coax cable and I<sup>2</sup>C communication with a USB cable connected to the deserializer board. Refer to the MAX9288/MAX9290 IC data sheet for detailed configuration information. See [Table 1](#) for the deserializer jumper settings and descriptions.

### Identify Devices Button

The **Identify Devices** button causes the GUI to scan the system and search for slave addresses on the bus. Upon successful communication, it reads the **Device ID** register from the DUT(s) and displays the corresponding jumper lists on the **Serializer Jumper Selection** and **Deserializer Jumper Selection** blocks. It is also

possible to manually select a device from the **Device ID** drop-down list and manually change slave address in the **Device Address** edit box. It is a good practice to utilize the **Identify Devices** button and verify communication with the DUTs before attempting to **Connect**.

To enable the control channel and communicate with the serializer without applying PCLK, select **Enable CLINK Identify** and then press the **Connect** button.

The following sections provide a brief overview of the function buttons on the **Configuration Settings** window.

### Connect Button

The **Connect** button opens up the **Evaluation Kit** window. The GUI reads the SerDes registers and updates on-screen register maps for both. Successful communication is indicated by green LED indicators. The LED indicator's color glow red in case of a communication problem.

### Cancel - Do No Connect Button

The **Cancel - Do Not Connect** button opens the **Evaluation Kit** window without attempting to connect to the microcontroller. Although there is no communication with the microcontroller, all functions and tabs corresponding to the selected **Device IDs** on the **Evaluation Kit** window become active once there.

**Table 1. Deserializer Jumper Settings and Descriptions**

JUMPER*	SIGNAL	DEFAULT POSITION	FUNCTION
AVDD18 (JU30)	AVDD 1.8V	INT*	AVDD 1.8V supplied internally
		EXT	AVDD 1.8V supplied through the AVDD18 terminal
AVDD33 (JU32)	AVDD 3.3V	INT*	AVDD 3.3V supplied internally
		EXT	AVDD 3.3V supplied through the AVDD33 terminal
DVDD18 (JU31)	JU_DVDD	INT*	DVDD 1.8V supplied internally
		EXT	DVDD 1.8V supplied through the DVDD18 terminal
IOVDD (JU33)	IOVDD	3.3V*	IOVDD supplied internally
		2.5V	IOVDD supplied internally
		1.8V	IOVDD supplied internally
		EXT	IOVDD supplied through the IOVDD terminal
J6	IOVDD	Short*	Measure current drawn by U1 through the IOVDD pin
J6	JU_VDDIO	Short*	VDDIO applied to U1
		Open	Connect amp meter to measure current drawn by U1 through the IOVDD pin
JU3	PCB main power	USB*	5V supplied from the USB port
		REG	5V supplied from the external supply applied on the +5V terminal
		+5VN	Not an option in the rev P2 PCB. <b>Warning:</b> Power applied on the +5VIN terminals is directly applied to the board circuitry fighting with selection on JU3.

**Table 1. Jumper Settings/Descriptions (continued)**

JUMPER*	SIGNAL	DEFAULT POSITION	FUNCTION
BWS	JU_BWS	L*	PCLKIN > 12.5MHz, 32-bit mode
		H	PCLKIN > 12.5MHz, 32-bit mode
		Open	PCLKIN > 33.33MHz 27-bit high bandwidth
I2CSEL (JU18)	I2CSEL	L*	UART-to-UART or UART-to-I <sup>2</sup> C mode
		H	I <sup>2</sup> C-to-I <sup>2</sup> C mode
GPI (JU24)	GPI	L*	GPI pin pulled low
		H	GPI pin pulled high
CX_TP (JU34)	CXTP	L	STP Link (Table 5)
		H*	Coax+ Link (Table 5)
CDS	CDS	L*	μC is connected at the serializer side
		H	μC is connected at the deserializer
HIM	HIM	L*	Reveres channel in legacy mode
		H	Reveres channel in high immunity mode
MS	MS	L*	Base mode
		H	Bypass mode
PWDN	PWDN	H*	Deserializer is powered on
		L	Deserializer is powered off
HS_RX	RX/SDA	RX*	UART-to-UART or UART-to-I <sup>2</sup> C mode
		SDA	I <sup>2</sup> C-to-I <sup>2</sup> C mode
HS_RX	RX/SDA	RX*	UART-to-UART or UART-to-I <sup>2</sup> C mode
		SDA	I <sup>2</sup> C-to-I <sup>2</sup> C mode
GPIO0 (JU16)	GPIO0	L	GPIO0 pin is forced low
		H	GPIO0 pin is forced high
		Open*	U1 drives GPIO0 pin
GPIO1 (JU17)	GPIO1	L	GPIO1 pin is forced low
		H	GPIO1 pin is forced high
		Open*	U1 drives GPIO1 pin
ADD0 (JU19)	ADD0/CNTL0	L*	See Table 5
		H	See Table 5
ADD1 (JU20)	ADD1/CNTL3	L*	See Table 5
		H	See Table 5
ADD2 (JU23)	ADD2/CNTL2	L*	See Table 5
		H	See Table 5
J11	VDD_REF	Short*	U8 and U37 level shifters supply is from internal 3.3V.
		Open	U8 and U37 level shifters supply is applied externally through J12-1.
J12	External μC connection	—	Apply external μC RX/SDA, TX/SCL, GND to pins as marked. The logic level can be selected from internal 3.3V (J11) or applied externally on pin 1.

**Table 1. Jumper Settings/Descriptions (continued)**

JUMPER*	SIGNAL	DEFAULT POSITION	FUNCTION
J9	U6 1st time programming pins	—	Factory use only
J3	LMN1	Open	Negative input (IN-) line fault monitor circuit on the serializer, J1 must be short.
		Short*	Negative input (IN-) line fault monitor circuit on the deserializer, J1 must be open.
J1	LMN1	Open*	Negative input (IN-) line fault monitor circuit on the deserializer, J3 must be short.
		Short	Negative input (IN-) line fault monitor circuit on the serializer, J3 must be open.
J8		Open	Positive input (IN+) line fault monitor circuit on the serializer, J1 must be short.
		Short*	Positive input (IN+) line fault monitor circuit on the deserializer, J1 must be open.
J2		Open*	Positive input (IN+) line fault monitor circuit on the deserializer, J3 must be short.
		Short	Positive input (IN+) line fault monitor circuit on the serializer, J3 must be open.

\*Jumper selections in the **Serializer/Deserializer** group boxes on the **Configuration Settings** window are for reference only and do not affect software operation.

**Table 2. Device Address Selection**

PIN		DEVICE ADDRESS (binary)								SERIALIZER DEVICE ADDRESS (hex)	DESERIALIZER DEVICE ADDRESS (hex)
ADD1	ADD0	D7	D6	D5	D4	D3	D2	D1	D0		
Low	Low	1	0	0	X*	0	0	0	R/W	80	90
Low	High	1	0	0	X*	0	1	0	R/W	84	94
Low	Open	1	0	0	X*	1	0	0	R/W	88	98
High	Low	1	1	0	X*	0	0	0	R/W	C0	D0
High	High	1	1	0	X*	0	1	0	R/W	C4	D4
High	Open	1	1	0	X*	1	0	0	R/W	C8	D8
Open	Low	0	1	0	X*	0	0	0	R/W	40	50
Open	High	0	1	0	X*	0	1	0	R/W	44	54
Open	Open	0	1	0	X*	1	0	0	R/W	48	58

\*X = 0 for the serializer address; X = 1 for the deserializer address.

### Evaluation Kit Window

The **Evaluation Kit** window provides access to all internal registers and functions of the DUTs by means of reading and writing registers through different tabs to allow user to evaluate various functions of the serializer and deserializer.

The **Read All** button updates the serializer and deserializer on screen register maps by reading the DUTs internal registers.

The **Serializer** group box provides pushbuttons to update the serializer’s register map from the DUT using the **Read All MAX9279** button, or update from a previously saved file using the **Load** button or save the existing register values into a file using the **Save** button.

The **Deserializer** group box provides pushbuttons to update the deserializer’s register map from the DUT using the **Read All MAX9290** button, or update from a previously saved file using the **Load** button or save the existing register values into a file using the **Save** button.

The **Wake Up** button applies the register write sequence described in the respective SerDes IC data sheet to wake up the DUTs from sleep mode.

The **Open Configuration** button returns the control to the **Configuration Settings** window.

The following sections describe the tabs available on the **Evaluation Kit** window.

### MAX9279 Ser Tab

The **MAX9279 Ser** tab (Figure 5) lists the serializer registers’ bit maps. **Read** and **Write** buttons in each register group box allow access to each bit, or group of bits, that specify a function or condition, as defined in the serializer IC data sheet. The color of the small LED indicator next to the **Read/Write** buttons indicates the communication status. Red indicates failed communication and green indicates successful communication.

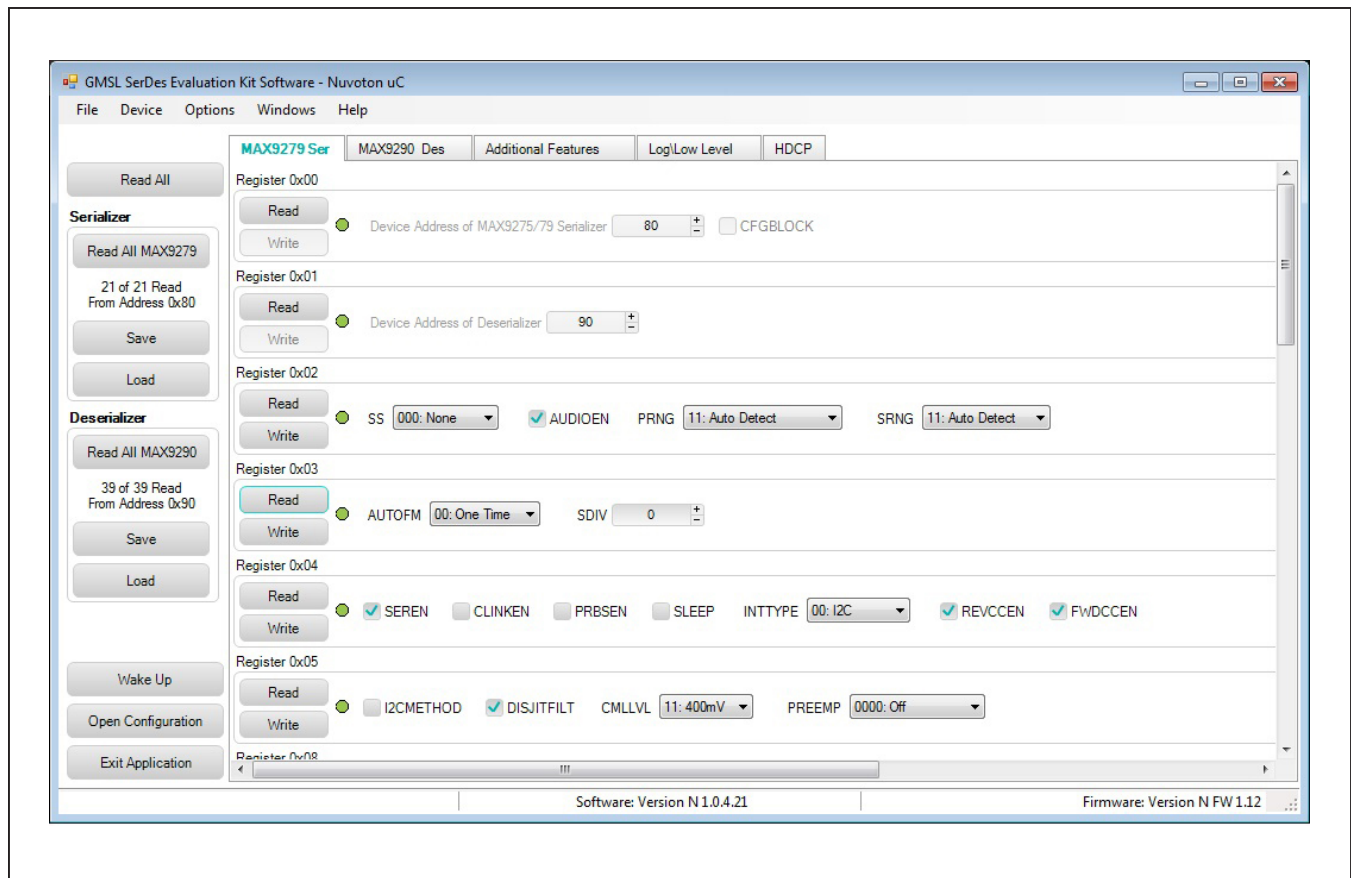

Figure 5. MAXSerDesEV-N EV Kit Software: Evaluation Kit Window (MAX9279 Serializer Tab) Shown with MAX9279, MAX9290 EV Kits Connected

**MAX9290 Des Tab**

The **MAX9290 Des** tab (Figure 6) lists the deserializer’s registers bit maps. The **Read** and **Write** buttons in each register group box allows access to each bit, or group of bits, that specify a function or condition as defined in the MAX9288/MAX9290 IC data sheet. The color of the small LED indicator next to the **Read/Write** buttons indicates the communication status. Red indicates failed communication, and green indicates successful communication.

**Additional Features Tab**

The **Additional Features** tab (Figure 7) provides pushbuttons for specific functions that connected devices can perform. By pressing a button, a window opens and allows the specific function to be executed. Function buttons that are not supported by the selected devices are grayed out.

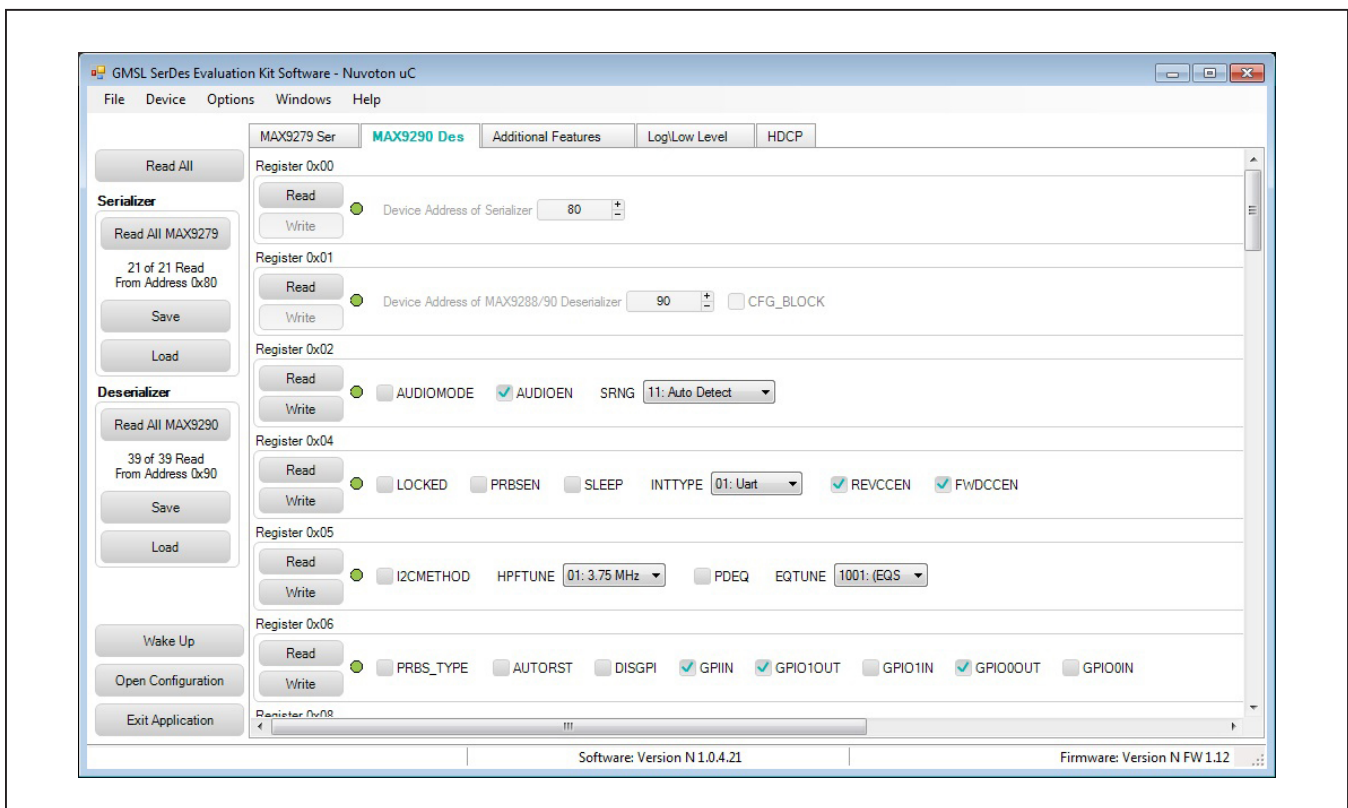

Figure 6. MAXSerDesEV-N EV Kit Software: Evaluation Kit Window (MAX9290 Deserializer Tab) Shown with MAX9279, MAX9290 EV Kits Connected



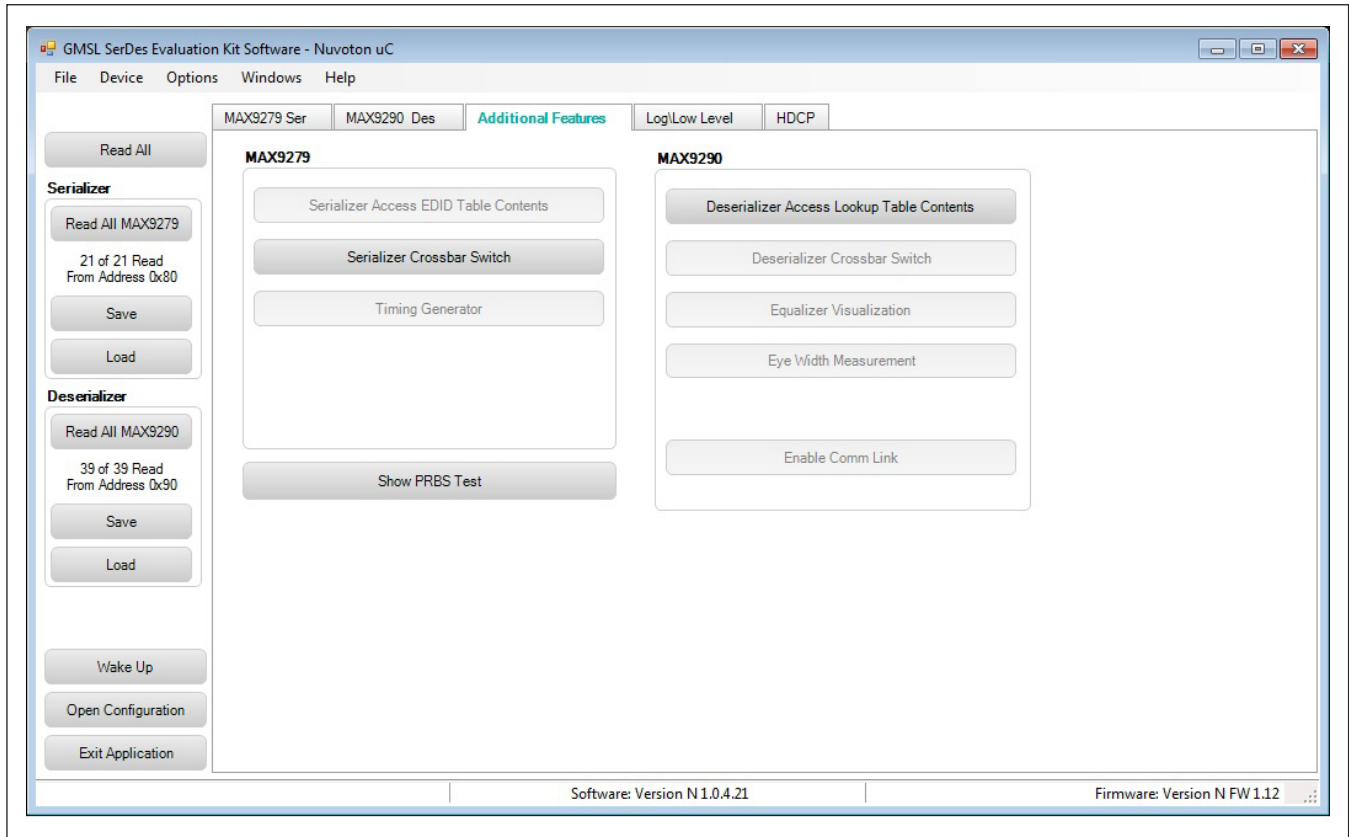

Figure 7. MAXSerDesEV-N EV Kit Software: Evaluation Kit Window (Additional Features Tab) Shown with MAX9279, MAX9290 EV Kits Connected

### Access Lookup Table Button

The **Access Lookup Table** button provides access to the **Lookup Tables (LUTs)** of the deserializer (Figure 8). Use this function to program/view/edit the LUT settings of the red, green, and blue colors for color translation. LUT content edits can be performed on the entire 256 bytes of all three colors, on an individual color table, or on an individual pixel of any color table. The LUT contents can be saved in a .csv file format for future reference or to be used as a template. Also, LUT contents can be uploaded from a valid existing file. A sample LUT content file is included in the EV kit software package.

### PRBS Test Button

Press the **Show PRBS Test** button (Figure 9) to perform the PRBS test. Note that this button toggles between **Show PRBS Test** and **Hide PRBS Test**. Enter a test duration (maximum 32,767s = 9.1hrs) in the **Duration** edit box and press the **Start** button to begin the test. At completion of the test, the number of bit errors are read from the PRBSERR register and reported in the **PRBS Error Counter** box.

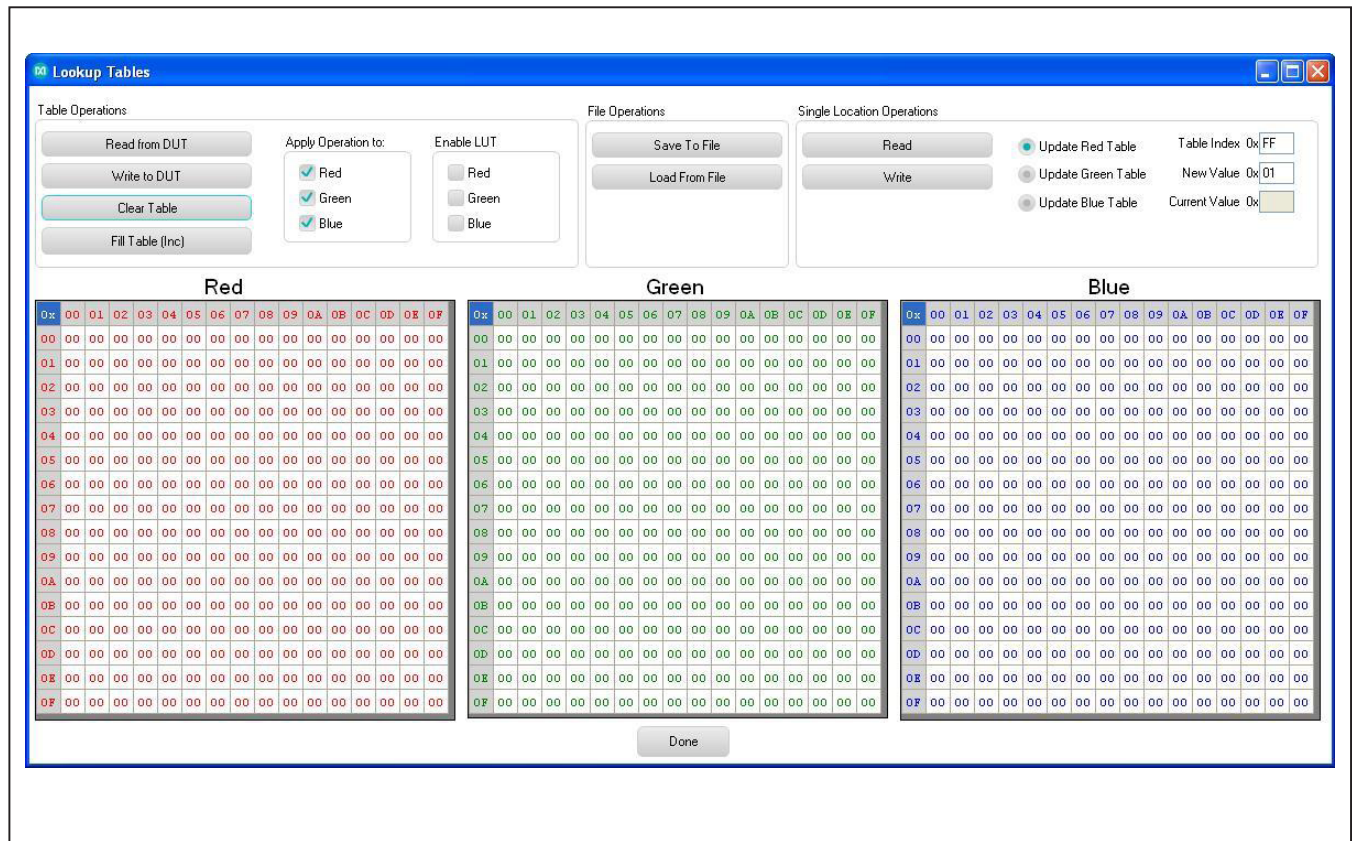

Figure 8. MAXSerDesEV-N EV Kit Software: Evaluation Kit Window (Lookup Table Window)

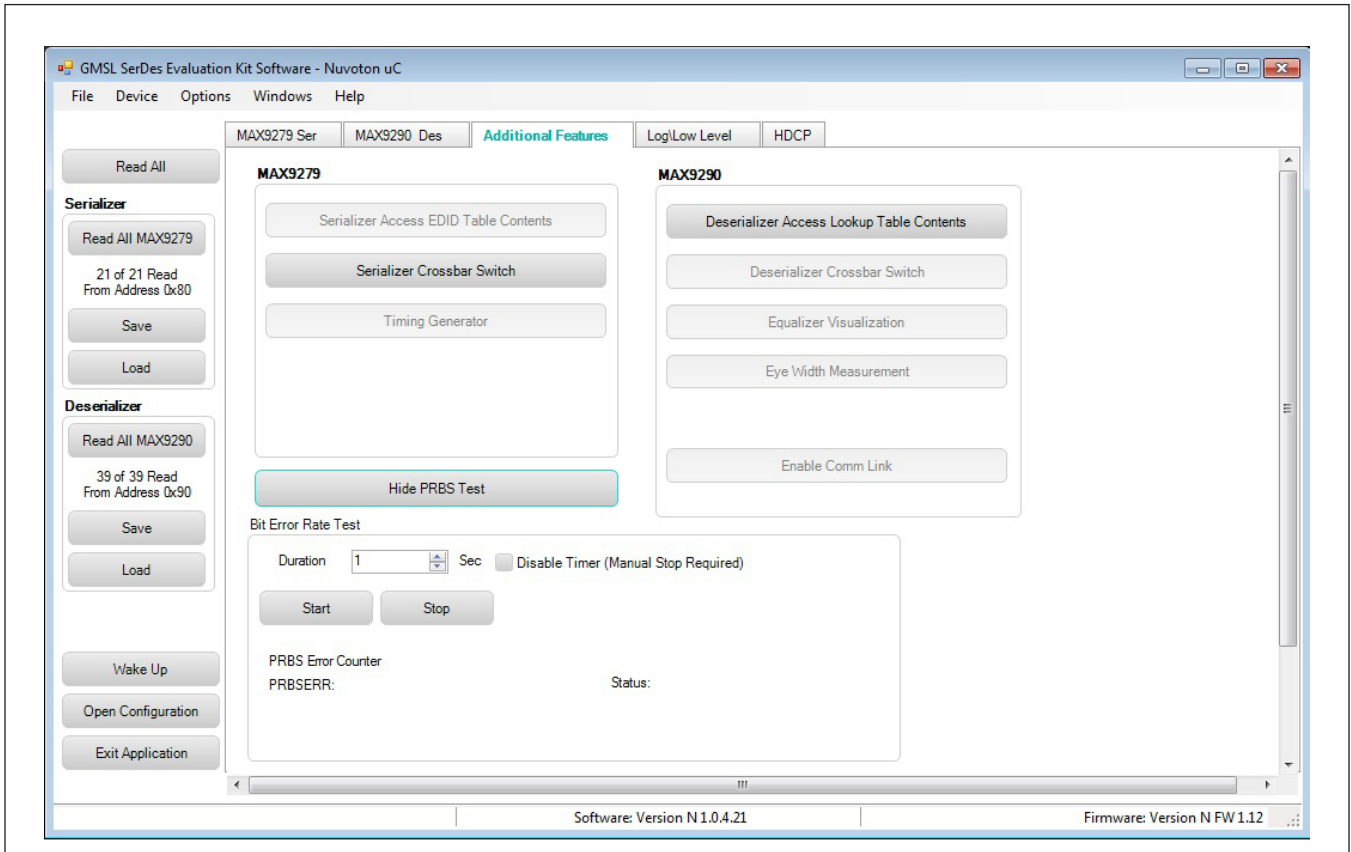

Figure 9. MAXSerDesEV-N EV Kit Software: Evaluation Kit Window (Additional Features Tab with PRBS Test Window Expanded) Shown with MAX9279, MAX9290 EV Kits Connected

### Log\Low Level Tab

The **Log\Low Level** tab (Figure 10) logs all activities between the GUI and DUTs.

The **Register Access** group box allows **Read** or **Write** of specified slave and register addresses. Use the **Send String to EVKIT** button to communicate with devices that are not register based (such as the MAX7324). The **SerDes Baud Rate (I2C and Uart)** drop-down list sets the communications baud rate. Note that the baud rate should be changed in small increments/decrements (one step change is forced by the GUI).

### HDCP Tab

The HDCP tab (Figure 11) displays the HDCP registers of both the serializer and deserializer, listed side-by-side with **Read** and **Write** buttons for each register. The **Authenticate** and **Enable Encryption** pushbuttons initiate the HDCP verification process and at the end of the operation, the color of the LED indicator next to the buttons indicates success or failure of the function.

**Note:** This tab is only functional for HDCP-capable DUTs.

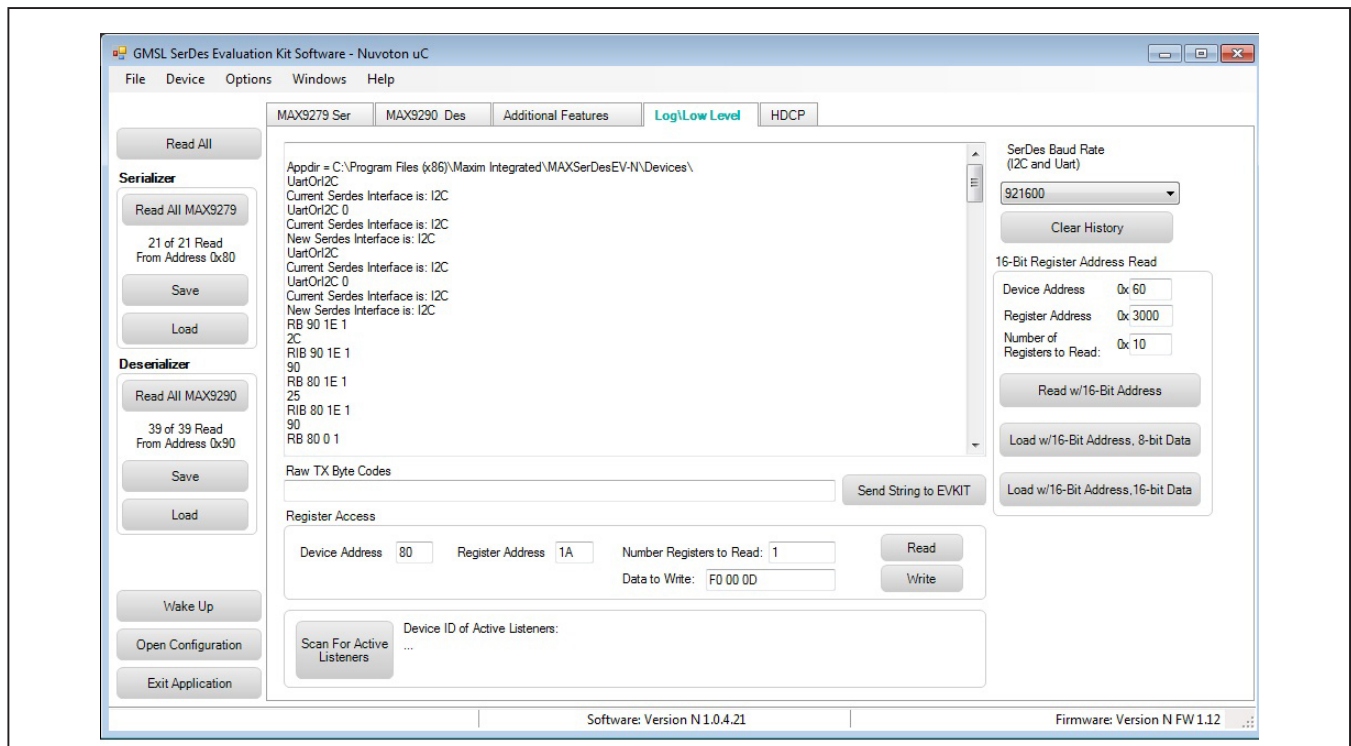

Figure 10. MAXSerDesEV-N EV Kit Software: Evaluation Kit Window (Log\Low Level Tab) Shown with MAX9279 and MAX9290 EV Kits Connected

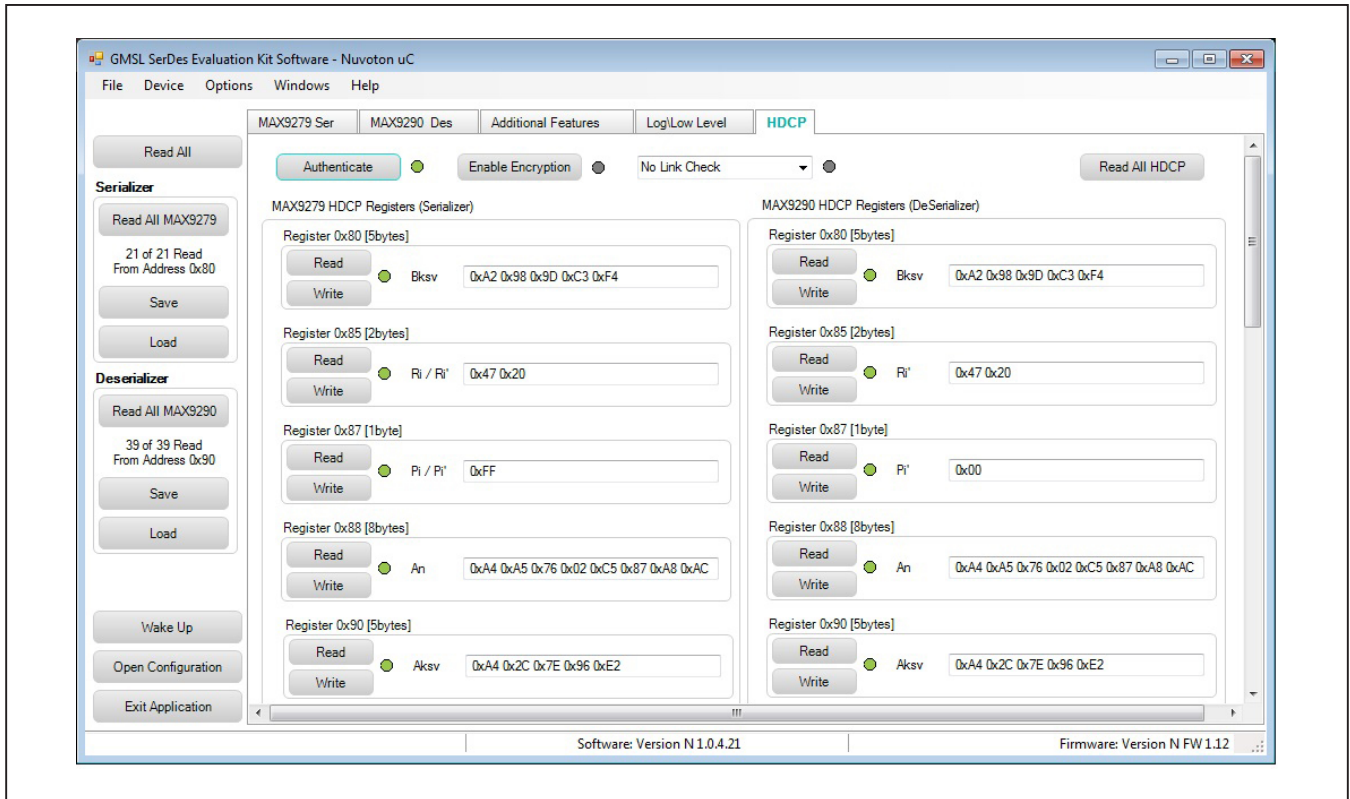

Figure 11. MAXSerDesEV-N EV Kit Software: Evaluation Kit Window (HDCP Tab) Shown with MAX9279 and MAX9290 EV Kits Connected

## Detailed Description of Firmware

The Nuvoton microcontroller (U12) runs a custom firmware that ensures reliable communication between the PC and DUTs. The firmware records 9-bit even-parity data received from the USB interface while RTS is set, and plays back the 9-bit data with 1.5 stop bits timing when RTS is cleared. Data received from the DUTs is immediately relayed to the USB port.

### How to Update Firmware

To update the Nuvoton microcontroller firmware, follow the instructions in the Updating MAXSerDesEV-N firmware.PDF file, which is available in the "...\\Program Files\\Maxim Integrated\\MAXSerDesEV-N\\Firmware Update" folder.

## Detailed Description of Hardware

The MAX9288/MAX9290 coax EV kit provides a proven design and layout for the MAX9288/MAX9290 GMSL deserializers, designed for a standard HDMI connector input and a FAKRA coaxial cable serialized output. On-board level translators and an easy-to-use USB-PC connection are included with the EV kit.

The MAX9288/MAX9290 coax EV kit board comprises three principal functional blocks:

- Power-supply block
- MAX9288/MAX9290 application circuit block
- Microcontrollers (U6–U10) block

### On-Board Controller

The microcontroller on the EV kit board provides the UART and I<sup>2</sup>C interface (through U6 and U10) that communicates with both the SerDes boards when they are powered on and properly configured.

### Externally Applied Controller

To use the EV kit with an externally applied controller, remove shunts from the JU5 header and connect the TX/SCL signal from the external controller to the middle pin of the JU5 header. Also remove the shunt from the JU6 header and connect the RX/SDA signal from the external controller to the middle pin of the JU6 header. Connect the logic level of the external controller (VDD) to the J12.1 pin (next to the SW122 switch) labeled VREF and connect the ground signal of the external controller to the GND pin on the J12.3 labeled GND.

Refer to the MAX9288/MAX9290 IC data sheet for details on read/write data formats.

## Power Supplies

On-board LDO regulators (U2–U5) generate the various voltage levels required to operate the EV kit, including voltage levels required for the Toshiba CSI-2-to-parallel bridge-chip board from a single power source applied to the board. There are three options to power the board (jumpers VDD and JU3 select among the three power sources):

- USB port (default)
- 12V AC adapter
- 5V power supply applied on the +5VIN terminals

To test with voltage levels different from what is generated by the board regulators, move the corresponding shunt on headers AVDD18 (JU30), DVDD18 (JU31), RVDD18 (JU9), IOVDD (JU33), HVDD33 (JU32), PLLVDD33 (JU8), and XVDD (JU7) from INT to EXT positions and apply the external voltage to the corresponding wire-loop terminal.

## Troubleshooting

Possible causes of board test failure include:

- Coax cable not properly connected between OUT+ of the serializer and IN+ of the deserializer: Reconnect and reverify.
- PCLKIN not applied (e.g., the FG output is disabled): Verify signal at the pins on the board.
- PCLKIN, function generator output not correct: Verify signal at the pins on the board.
- Incorrect jumper setting on deserializer board: Reverify.
- Incorrect jumper setting on the serializer board: Reverify.
- Bus selection on GUI is not consistent with jumpers' position on the boards: Check and verify that the USB cable has been properly connected.
- USB port has locked up: Exit the application/GUI, remove the USB cable from the board and reinsert, then relaunch the GUI.
- Nuvoton  $\mu$ C is not communicating: Exit the application/GUI, remove the USB cable from the board and reinsert, then relaunch the GUI.
- Deserializer board is faulty: Try a different board (if available).
- Serializer board is faulty: Try a different board (if available).

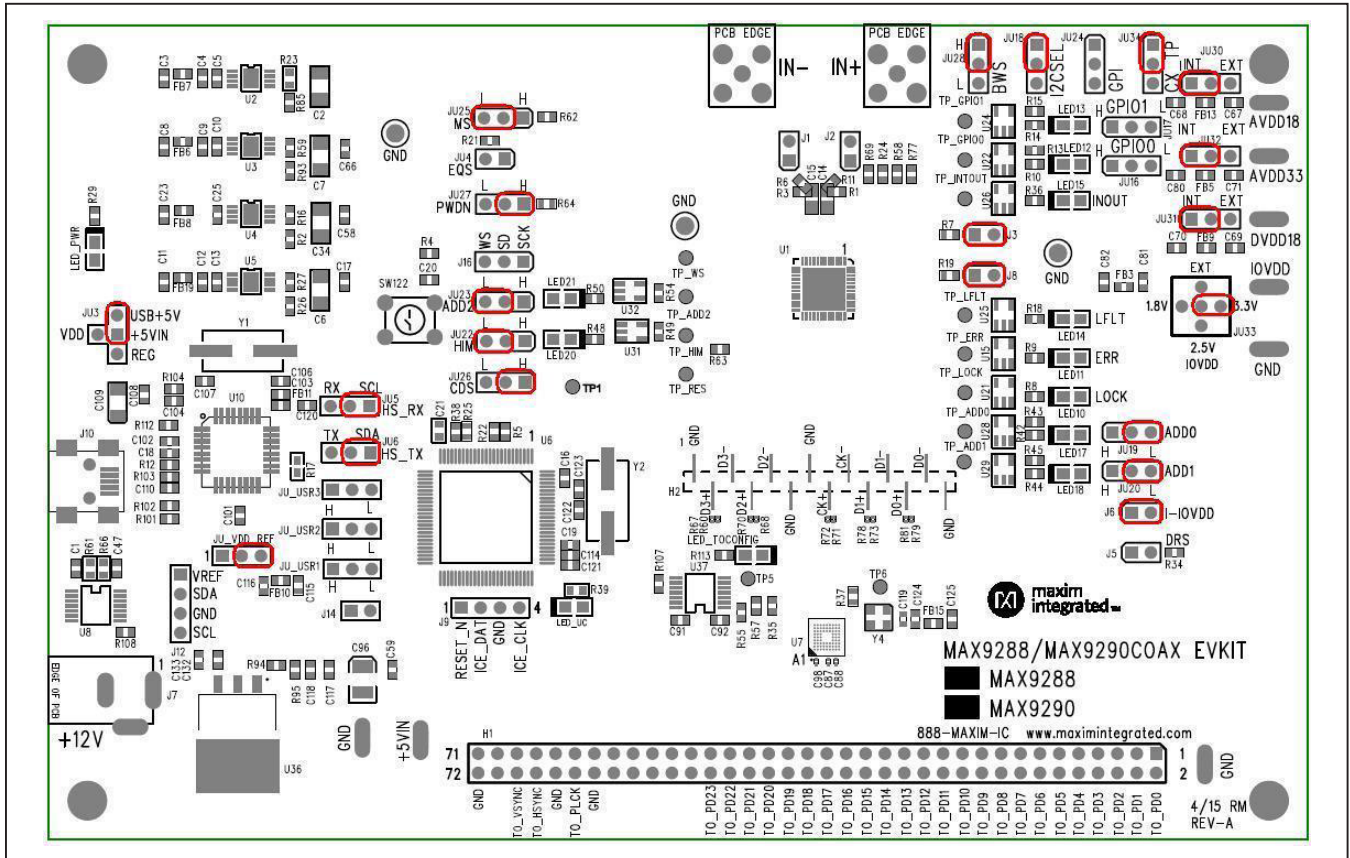

Figure 12. MAX9288/MAX9290 Coax EV Kit Jumper Settings for Coax Link and I2C Communication

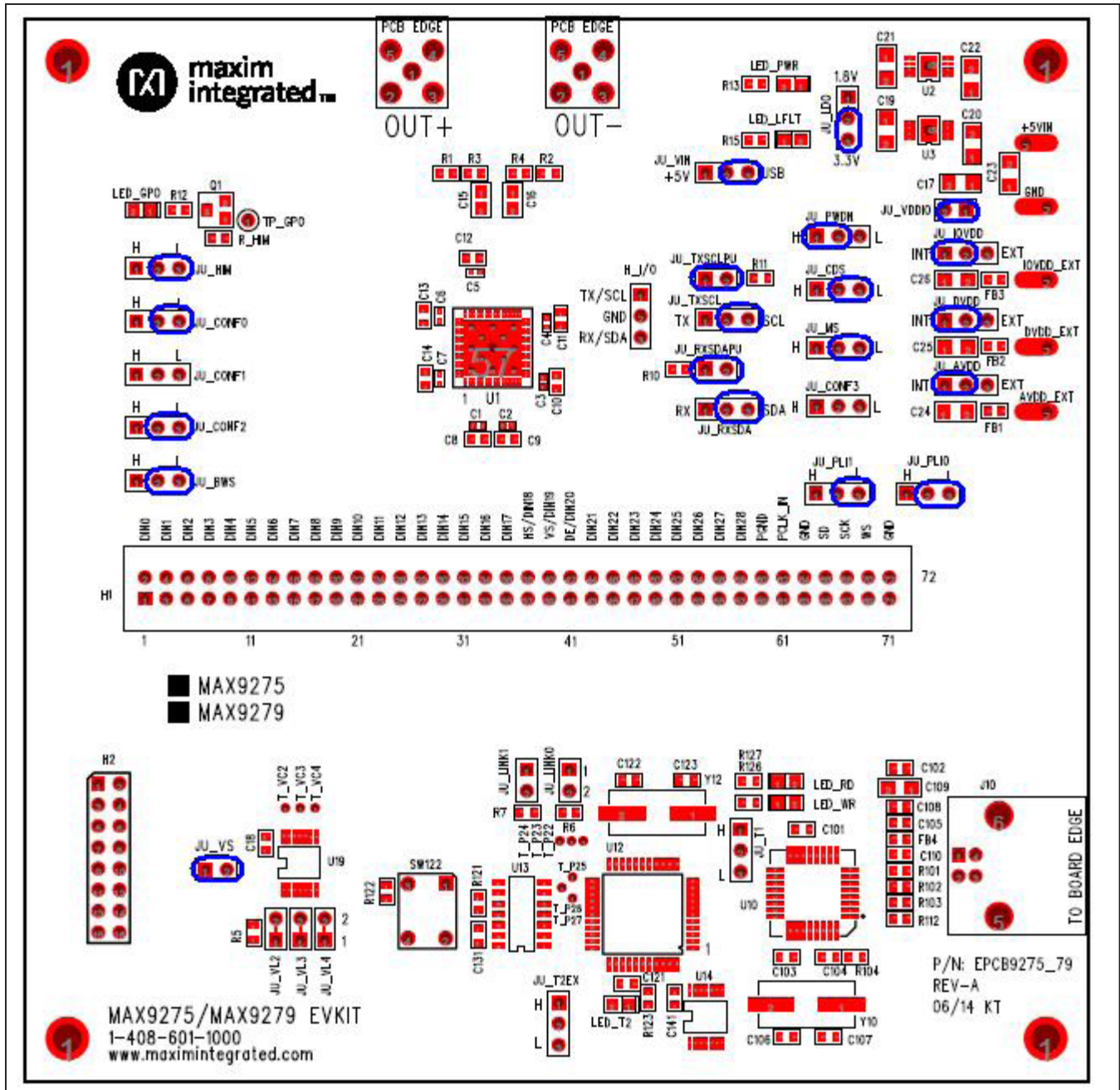

Figure 13. MAX9275/MAX9279 Coax EV Kit Jumper Settings for Coax Link and I<sup>2</sup>C Communication



MAX9288/MAX9290 EV Kit Bill of Materials

REF DESIGNATOR	QTY	DESCRIPTION	MFG. PART NO.
+5VIN GND GND HS_AVDD18 HS_AVDD33 HS_DVDD18 HS_IOVDD	7	Wire Loop 297 SILVER 100 FT Wire Loop 297 SILVER 100 FT	9020 Buss / 297 SV005
C1 C3 C5 C8 C10-11 C13 C23 C25 C47 C59 C91-92 C101-104 C108 C110 C114 C117 C120-121 C124-125 C131-132	27	CAP CER 0.1UF 25V 10% X7R 0603	GRM155R61C104K
C2 C6-7 C34 C109	5	CAP CER 10UF 16V 20% X7R 1206	GRM31CR71C106K
C4 C9 C12 C18 C20 C21 C118 C133	8	CAP CER 10UF 16V 20% JB 0603	JMK107BJ106MA-T
C14-15	2	CAP CER 0.22UF 50V 10% X7R 0805	CGJ4J2X7R1H224K125AA
C16 C17 C19 C58 C66-71 C80-82 C85 C89 C99 C115- 116	18	CAP CER 4.7UF 6.3V 20% X5R 0603	ECJ-1VB0J475K
C42-43 C53 C64 C86 C93 C100	7	CAP CER 3.3UF 4.0V X5R 0402	AMK105BJ335MV-F
C45-46 C48-52 C54 C62	9	CAP CER 0.1UF 16V 10% X7R 0402	GRM155R61A104K
C65 C72-79 C119	10	CAP CER 1000PF 50V 10% X7R 0402	C1005X7R1H102K
C87-88 C94 C97-98 C105 C111-113	9	CAP CER 0.1UF 10V 10% X5R 0201	GRM033R61A104K
C96	1	CAP CER 100UF 6.3V Y5V 1210	GRM32EF50J107ZE20L
C106-107 C122-123	4	CAP CER 22PF 50V 5% NP0 0603	C1608C0G1H220J
FB3 FB5-15 FB19	13	FILTER CHIP 120 OHM 3A 0603	BLM18SG121TN1D
H1	1	CONN HEADER 72POS .100 DUAL TIN	PEC36DAAN
IN+ IN-	2	FAKRA - HF RIGHT ANGLE PLUG	PE44651Z
J1-6 J8	7	2-Pin Male (cut-to-fit) Header .1 Center	929647-09-36-I
J7	1	CONN PWR JACK 2.1X5.5MM HIGH CUR	PJ-002AH
J9 J12	2	4-Pin Male (cut-to-fit) Header .1 Center	929647-09-36-I
J10	1	CONN MINI B USB R/A SMD	1734035-1
J14	1	DO NOT POPULATE 4-Pin Male (cut-to-fit) Header .1 Center	929647-09-36-I
JU2-3 JU5-7 JU15-20 JU22-32 JU34 JU_USR1-3 JU_VDD_REF	27	3-Pin Male (cut-to-fit) Header .1 Center	929647-09-36-I
JU33	1	5-Pin Male (cut-to-fit) Header .1 Center	929647-09-36-I
LED11-15 LED17-18 LED20-21 LED_PWR LED_UC	11	LED 650NM RED WTR CLR 0805 SMD	SML-210VTT86
LED10 LED_TOCONFIG	2	LED 570NM GREEN WTR CLR 0805 SMD	SML-210MTT86
R1 R3	2	RES 49.9K OHM 1/10W 1% 0603 SMD	ERJ-3EKF4992V
R2 R26 R59 R85 R93	5	RES 24.9K OHM 1/10W 1% 0603 SMD	CRCW060324K9FKEA
R4 R12 R55 R57 R107-108 R112	9	RES 10K OHM 1/10W 5% 0603 SMD	ERJ-3GEYJ103V
R5 R22 R25 R38	4	RES 10 OHM 1/10W 5% 0603 SMD	ERJ-3GEYJ270V
R6 R11	2	RES 4.99K OHM 1/10W 1% 0603 SMD	ERJ-3EKF4991V
R7 R19	2	RES 45.3K OHM 1/10W 1% 0603 SMD	ERJ-3EKF4532V
R8-10 R13-15 R18 R24 R29 R39 R34-37 R42 R44 R48 R50 R58 R62-64 R69 R77 R113	25	RES 1K OHM 1/10W 1% 0603 SMD	CR0603-FX-1001ELF
R16	1	RES 41.2K OHM 1/10W 1% 0603 SMD	CRCW060341K2FKEA
R17 R61 R66	1	RES 4.7K OHM 1/10W 5% 0603 SMD	ERJ-3GEYJ472V
R21	1	RES 30.1K OHM 1/10W 1% 0603 SMD	ERJ-3EKF3012V
R23	1	RES 11K OHM 1/10W 1% 0603 SMD	ERJ-3GEYJ113V

## MAX9288/MAX9290 EV Kit Bill of Materials (continued)

REF DESIGNATOR	QTY	DESCRIPTION	MFG. PART NO.
R27 R101-102	5	RES 27 OHM 1/10W 5% 0603 SMD	ERJ-3GEYJ270V
R43 R45 R49 R54	4	RES 30.0K OHM 1/10W 1% 0603 SMD	CRCW060330K0FKEA
R60	1	RES 0.0 OHM 1/10W 0201 SMD	ERJ-1GN0R00C
R67-68 R70-73 R78-79 R81	9	RES 0.0 OHM 1/10W 0201 SMD	ERJ-1GN0R00C
R94	1	RES 240 OHM 1/10W 5% 0603 SMD	ERJ-3GEYJ241V
R95	1	Thick Film Resistors - SMD 1/10watt 715ohms 1%	CRCW0603715RFKEA
R103	1	RES 1.5K OHM 1/10W 1% 0603 SMD	ERJ-3GEYJ152V
R104	1	RES 470 OHM 1/10W 5% 0603 SMD	ERJ-3GEYJ471V
SW122	1	SWITCH TACTILE SPST-NO 0.02A 15V	EVQ-PAD09K
TP5-6 TP_ADD0-2 TP_ERR TP_GPIO0-1 TP_HIM TP_INTOUT TP_LFLT TP_LOCK TP_RES TP_WS	14	TEST POINT PC MINI .040D RED"	5000K-ND
U1	1	3.12 Gbps GMSL Deserializer with CSI-2 Output and Programmable Coax or STP Cable Input	MAX9288GTM/V+
U1	1	3.12 Gbps GMSL Deserializer with CSI-2 Output and Programmable Coax or STP Cable Input	MAX9288GTM+
U1	1	3.12 Gbps GMSL Deserializer with CSI-2 Output and Programmable Coax or STP Cable Input, HDCP	MAX9290GTM/V+
U1	1	3.12 Gbps GMSL Deserializer with CSI-2 Output and Programmable Coax or STP Cable Input, HDCP	MAX9290GTM+
U10	1	IC USB FS SERIAL UART 32-LQFP	FT232BL-REEL
U2-5	4	500mA Low Dropout Linear Regulator	MAX1792EUA33
U36	1	Linear Regulators - Standard 3Pin 1.5A Adj Vltg Reg	LM317KTTR
U6	1	NUC140_LQFP_100	NUC140VE3CN or NUC130VE3CN
U7	1	TOSHIBA-TC358746XBG Functional Specification	TC358746XBG
U8 U37	2	±15kV ESD-Protected, 1A, 16Mbps, Dual/Quad	MAX3378EEUD+
U15 U21-22 U24-26 U28-29 U31-32	10	IC 2-IN EXCL-OR GATE 5TSSOP	74LVC1G86GW
X1	1	MAXIM LOGO	
X2-5	4	Mounting Hole	N/A
Y1	1	CRYSTAL 6.0MHZ 20PF SMD	FQ1045A-6
Y2	1	Crystals 12MHz 30ppm -20C +70C 631-1013-1-ND	ABLS-14.7456MHZ-B4-T
Y4	1	OSC MEMS 19.200 MHZ SMD	ASEMB-19.200MHZ-LY-T
—	1	PCB: MAX9288/MAX9290COAX EVKIT	MAXIM
—	1	Cable, Coax, FAKRA Cable (2m)	Rosenberger North America 02E-59K1-59K1-02000
—	1	CABLE, USB-A MALE to USB-mini MALE 6' BEIGE	

MAX9288/MAX9290 EV Kit Schematics

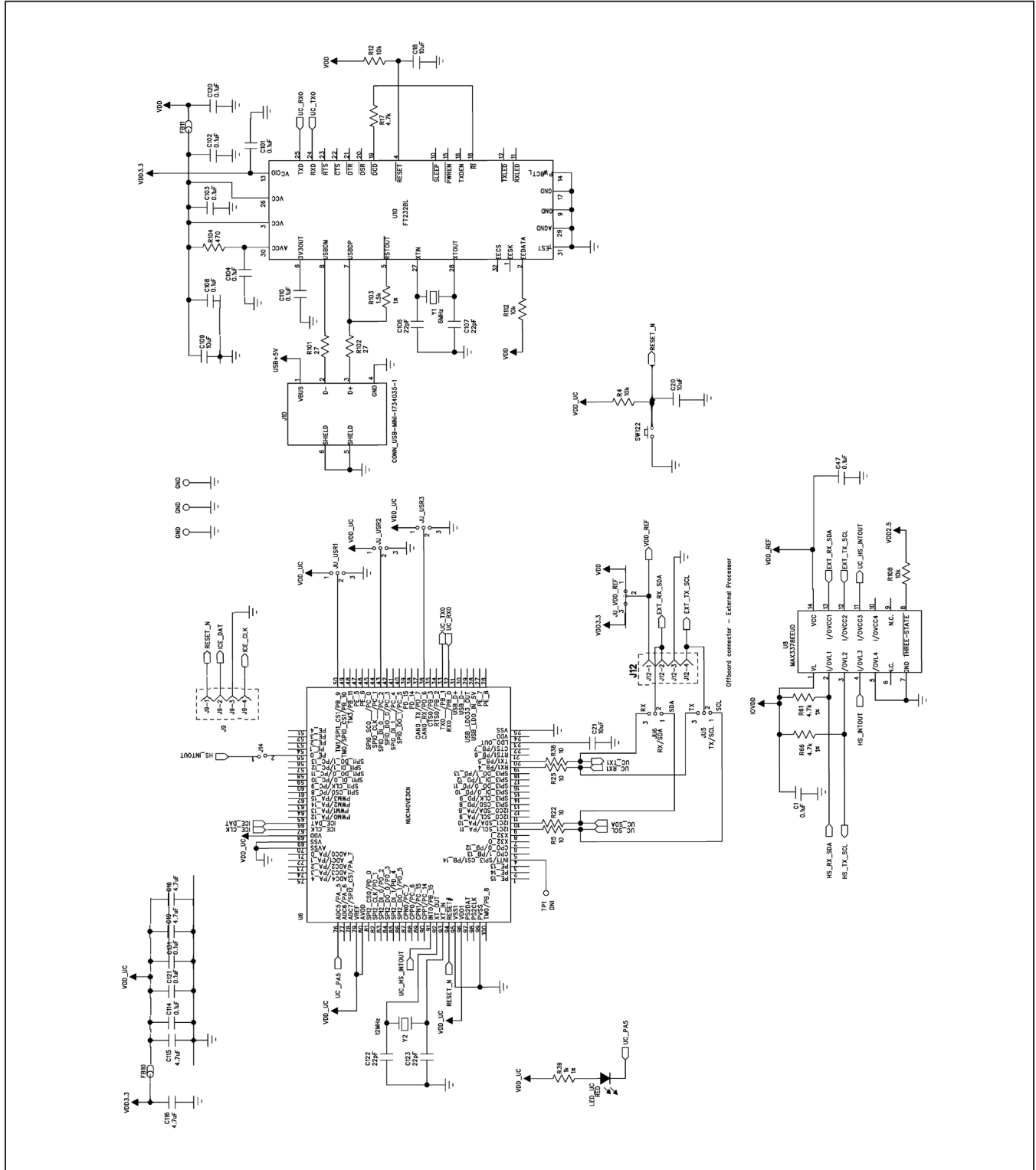

MAX9288/MAX9290 EV Kit Schematics (continued)

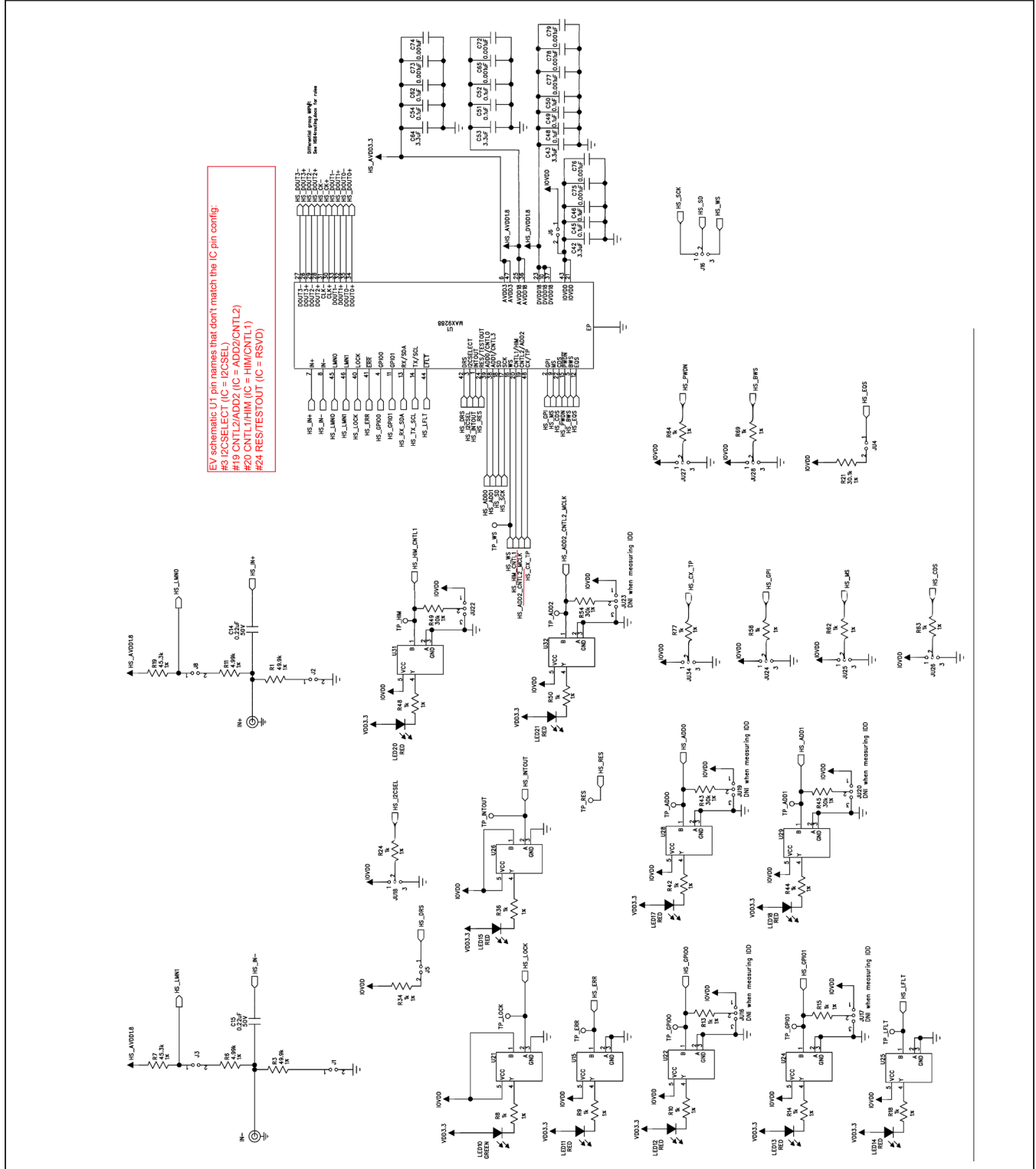

MAX9288/MAX9290 EV Kit Schematics (continued)

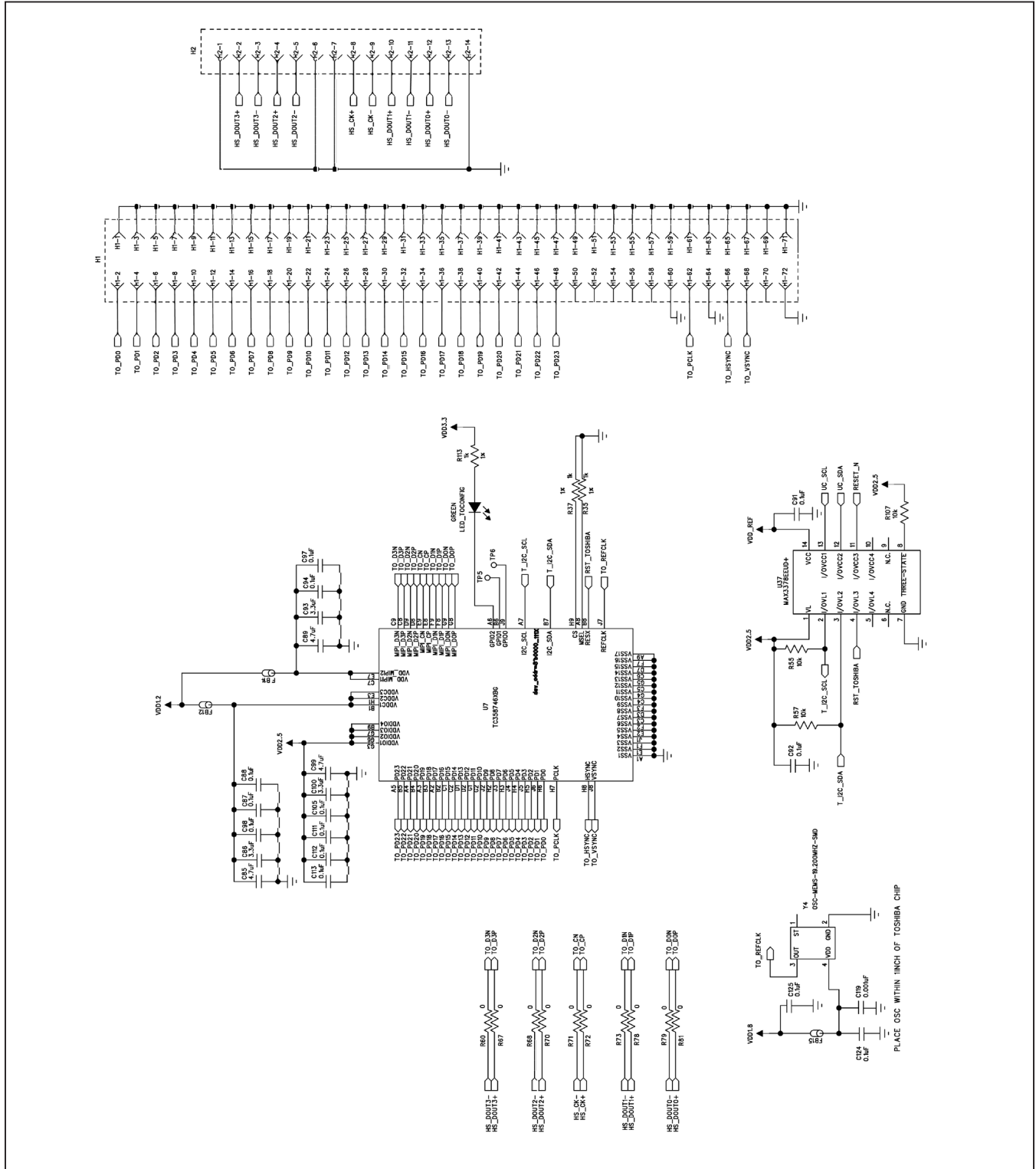

MAX9288/MAX9290 EV Kit Schematics (continued)

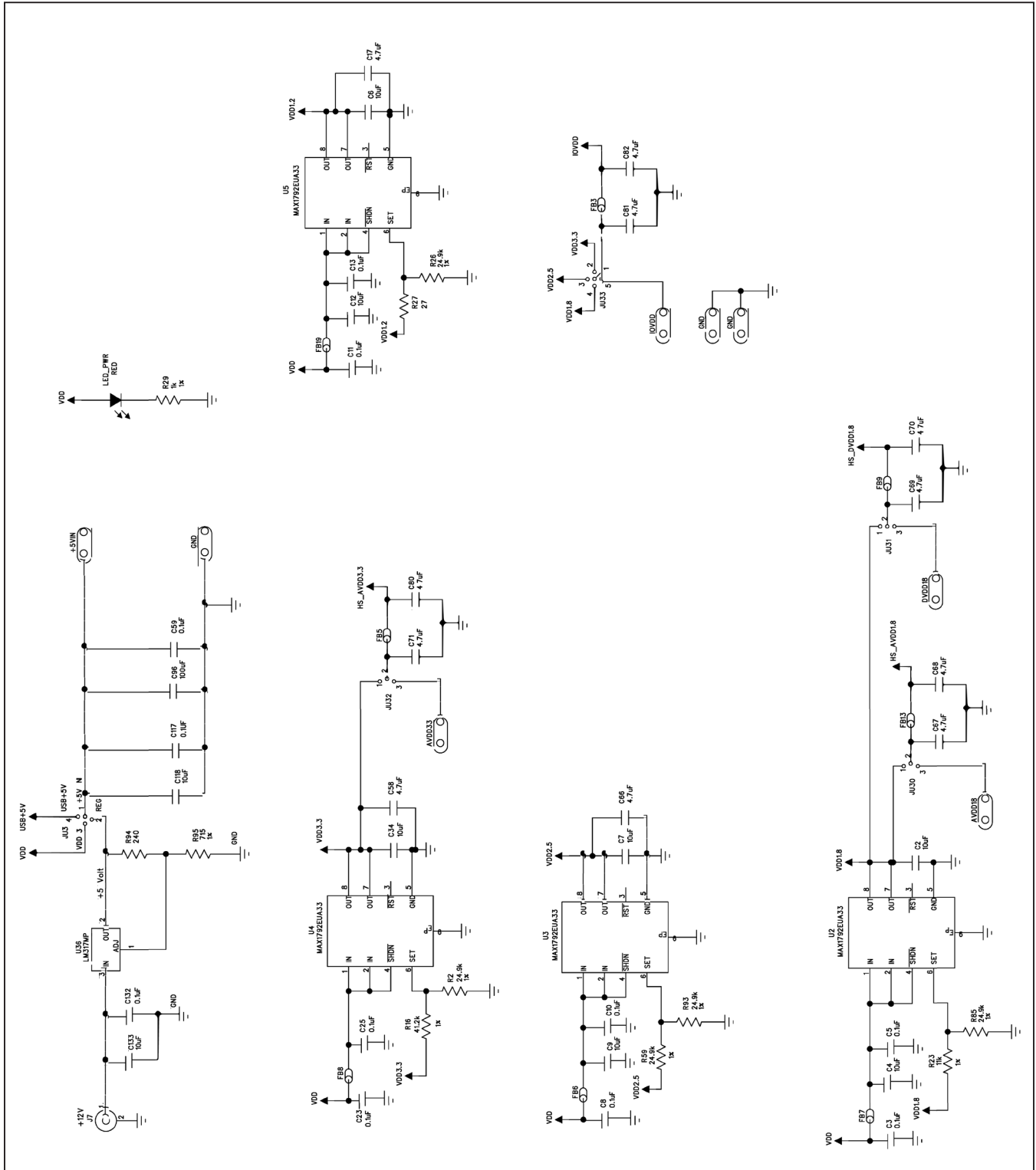

MAX9288/MAX9290 EV Kit PCB Layout Diagrams

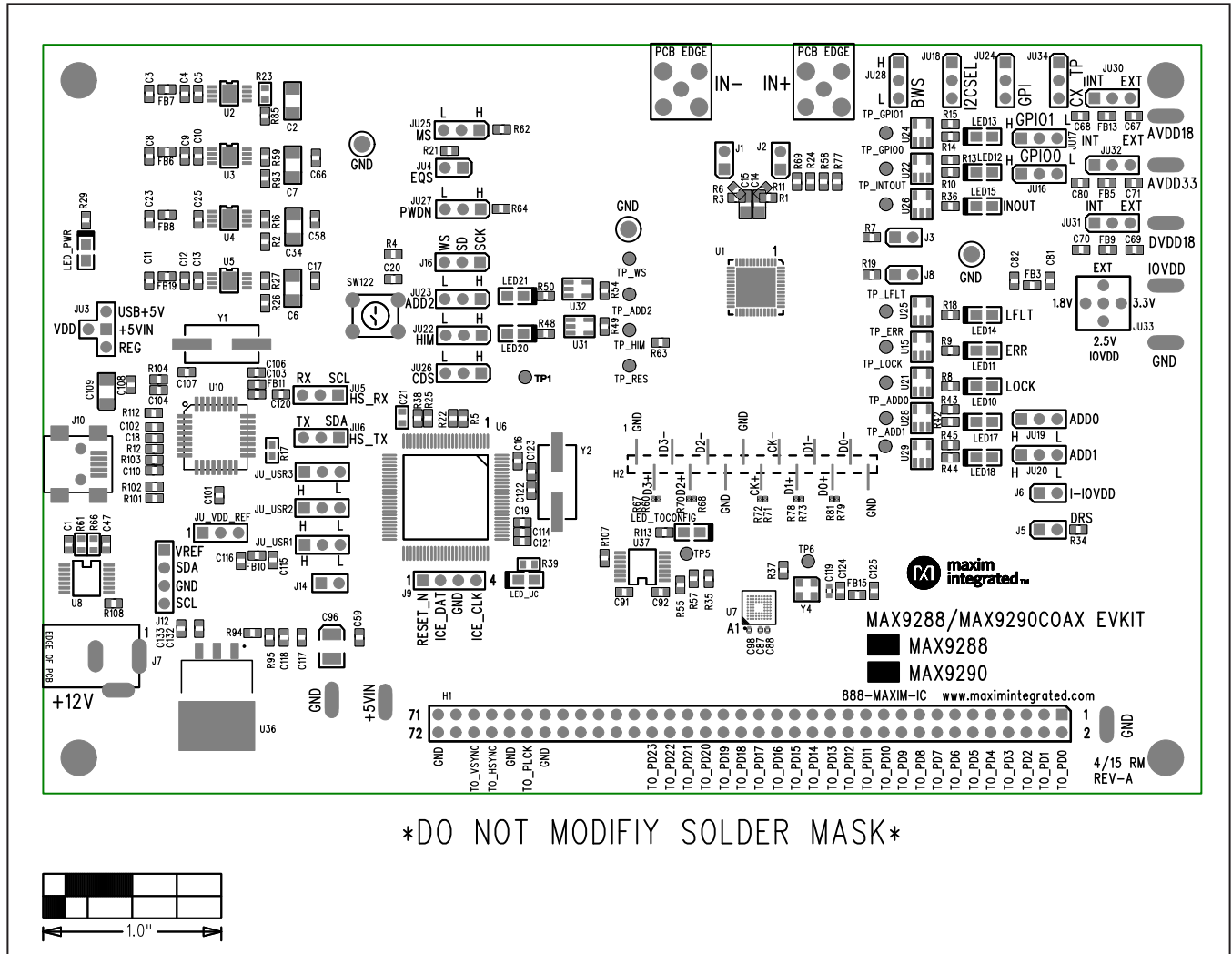

MAX9288/MAX9290 EV Kit—PCB01

MAX9288/MAX9290 EV Kit PCB Layout Diagrams (continued)

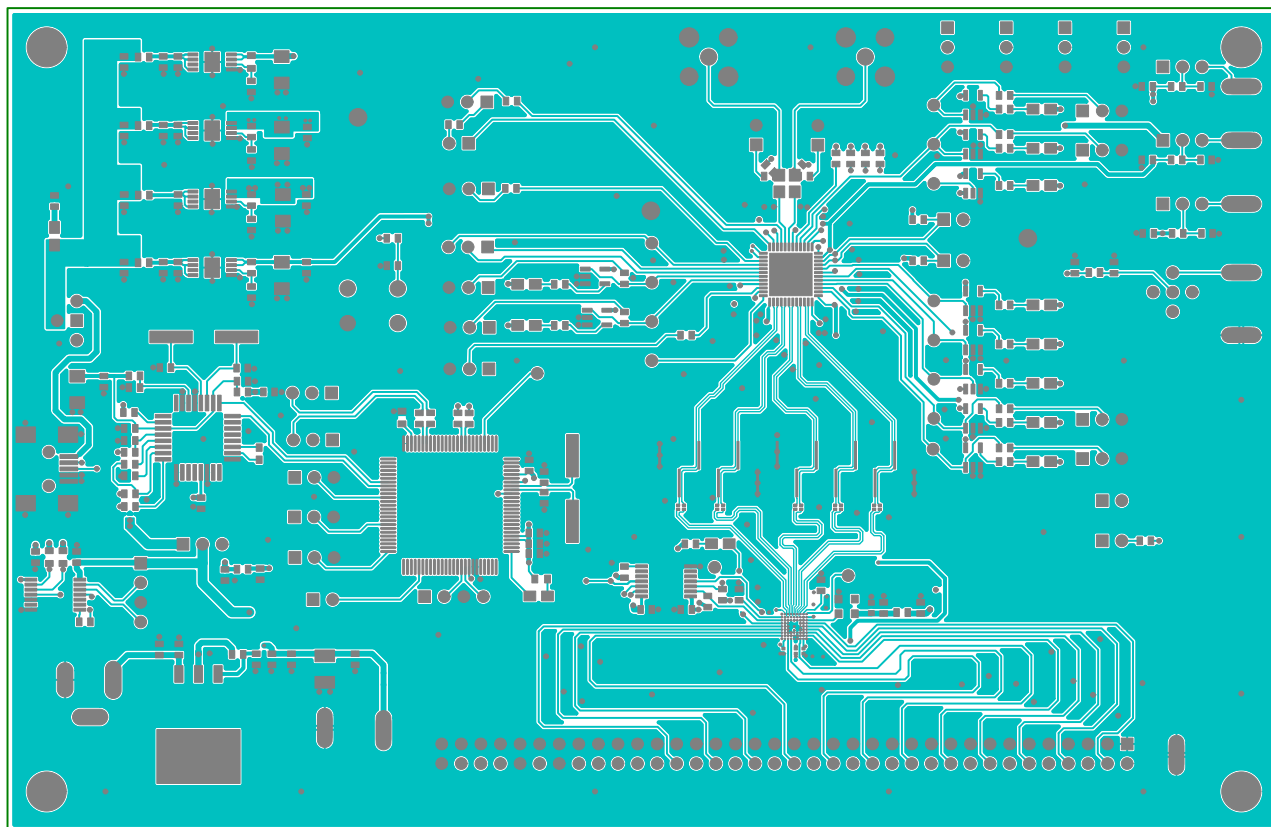

\*DO NOT MODIFY SOLDER MASK\*

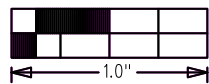

MAX9288/MAX9290 EV Kit—PCB02



MAX9288/MAX9290 EV Kit PCB Layout Diagrams (continued)

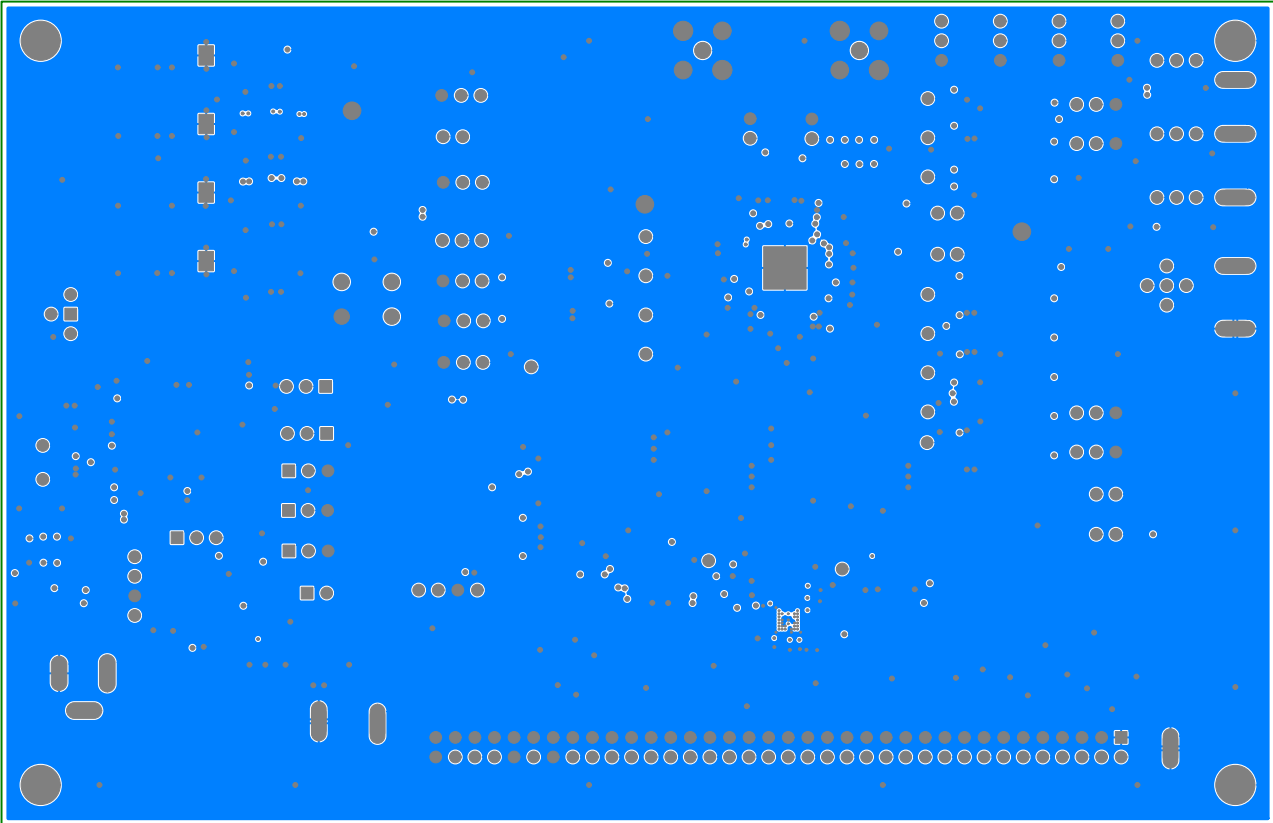

\*DO NOT MODIFY SOLDER MASK\*

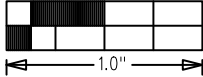

MAX9288/MAX9290 EV Kit—PCB03

MAX9288/MAX9290 EV Kit PCB Layout Diagrams (continued)

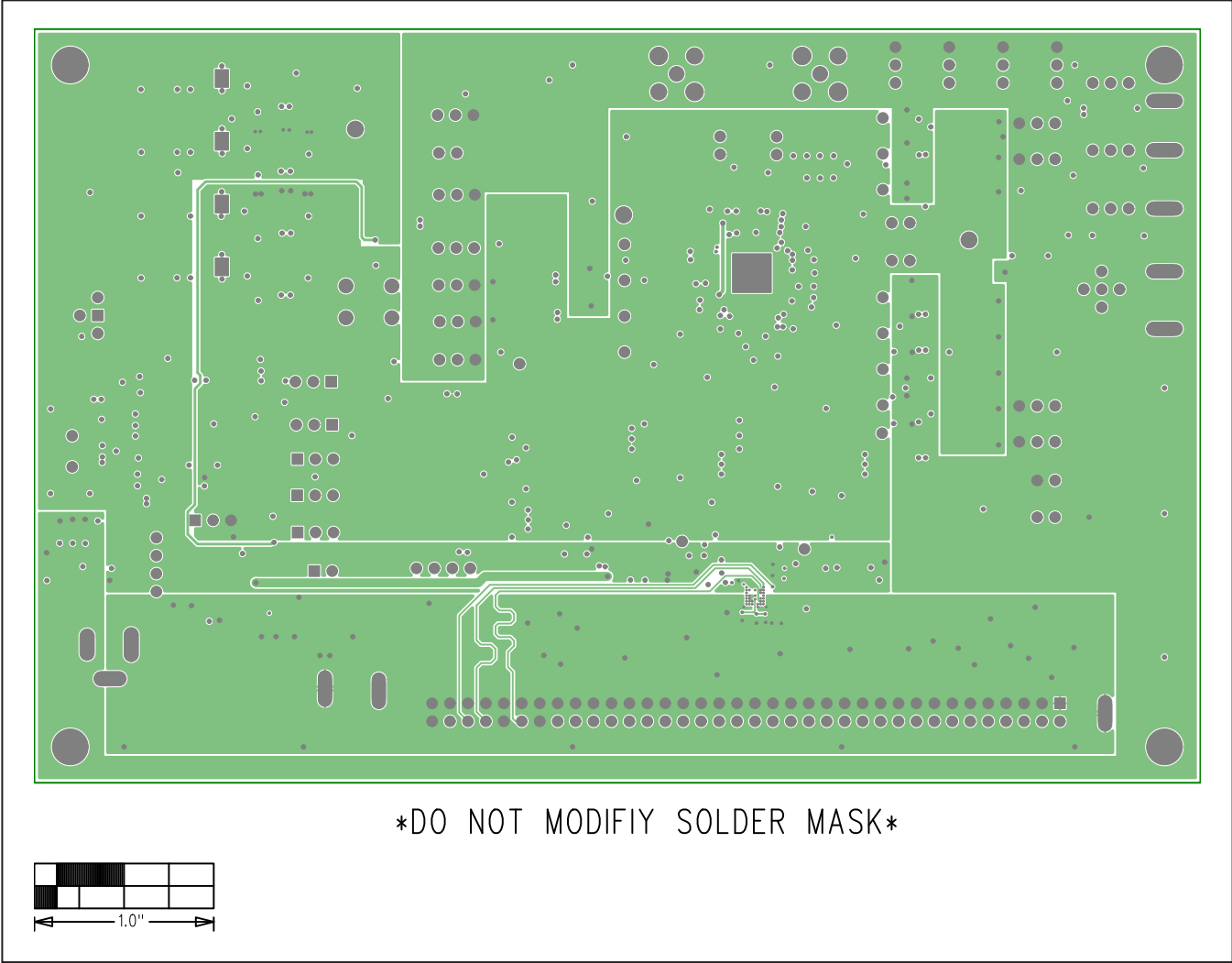

MAX9288/MAX9290 EV Kit—PCB04

MAX9288/MAX9290 EV Kit PCB Layout Diagrams (continued)

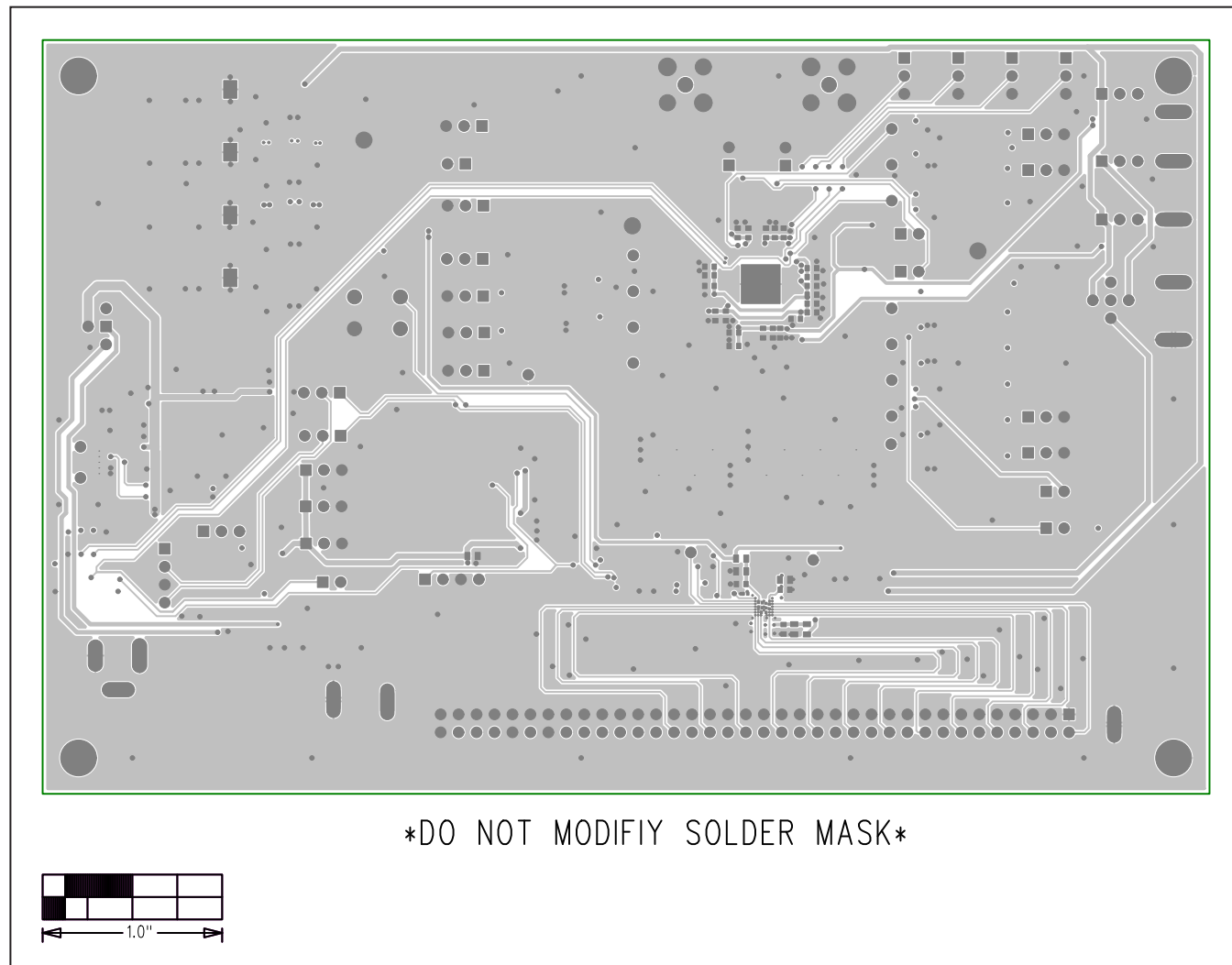

MAX9288/MAX9290 EV Kit—PCB05

MAX9288/MAX9290 EV Kit PCB Layout Diagrams (continued)

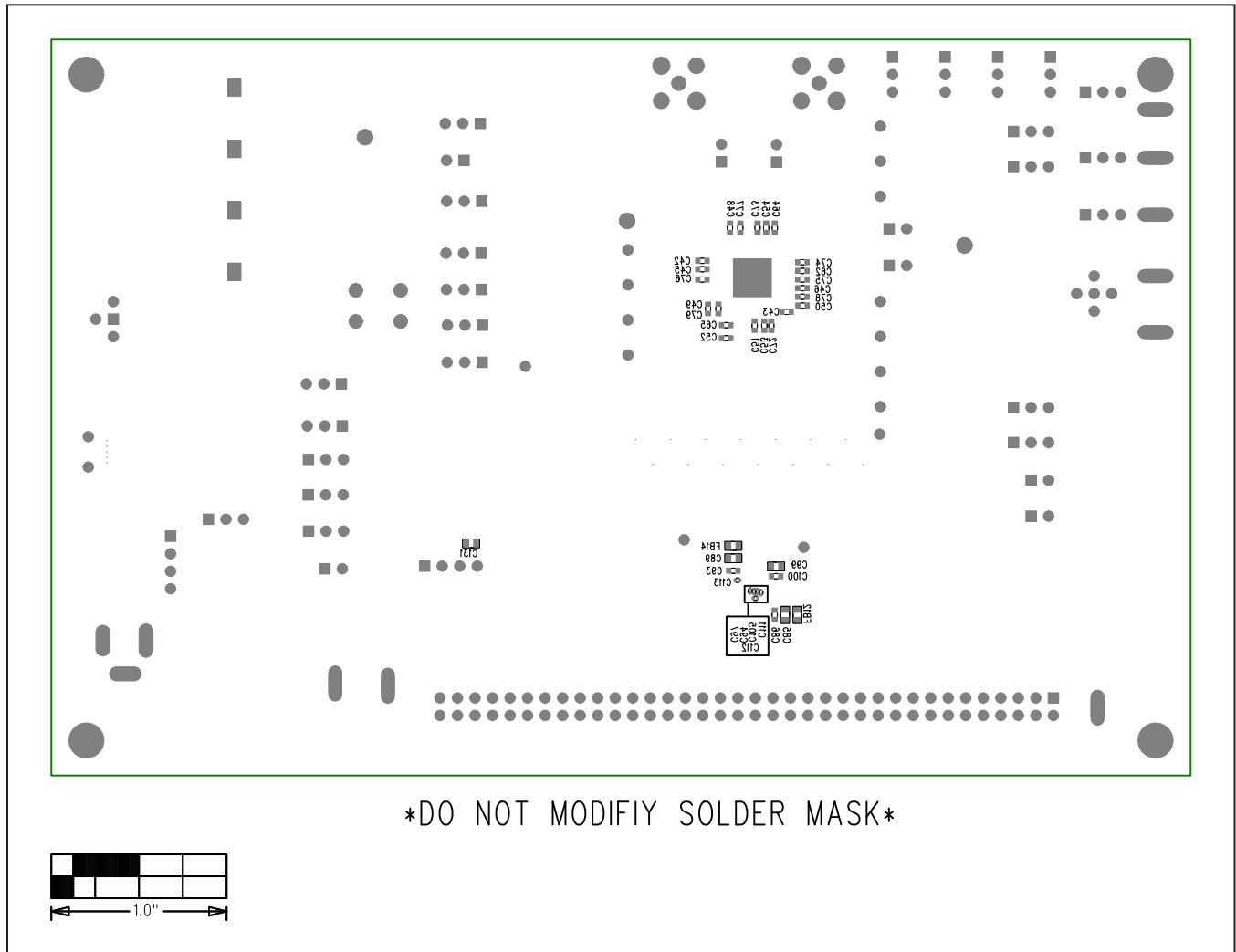

MAX9288/MAX9290 EV Kit—PCB06

Ordering Information

PART	TYPE
MAX9288COAXEVKIT#	EV Kit
MAX9290COAXEVKIT#	EV Kit
MAXCOAX2STP-HSD#	Adapter Kit

#Denotes RoHS compliant.

**Note:** The MAX9288 and MAX9290 deserializer coax EV kits are normally ordered with a companion serializer board:

- MAX9275A coax EV kit (MAX9275ACOAXEVKIT#), or
- MAX9279A coax EV kit (MAX9279ACOAXEVKIT#)