

MAXIM

Lowest Power 3.0GHz ECL/PECL Differential Data and Clock D Flip-Flop

MAX9381

General Description

The MAX9381 differential data, differential clock D flip-flop is pin compatible with the ON Semiconductor MC100EP52, with the added benefit of a wider supply-voltage range from 2.25V to 5.5V and 25% lower supply current. Data enters the master part of the flip-flop when the clock is low and is transferred to the outputs upon a positive transition of the clock. Interchanging the clock inputs allows the part to be used as a negative edge-triggered device. The MAX9381 utilizes input clamping circuits that ensure the stability of the outputs when the inputs are left open or at V_{EE} .

The MAX9381 is offered in an 8-pin SO package and the smaller 8-pin μ MAX package.

Applications

Precision Clock and Data Distribution
 Central Office
 DSLAM
 DLC
 Base Station
 ATE

Features

- ◆ 3.0GHz Guaranteed Operating Clock Frequency
- ◆ 0.2psRMS Added Random Jitter
- ◆ 328ps Typical Propagation Delay
- ◆ PECL Operation from $V_{CC} = 2.25V$ to 5.5V with $V_{EE} = 0V$
- ◆ ECL Operation from $V_{EE} = -2.25V$ to -5.5V with $V_{CC} = 0V$
- ◆ Input Safety Clamps Ensure Output Stability when Inputs are Open or at V_{EE}
- ◆ $\pm 2kV$ ESD Protection (Human Body Model)

Ordering Information

PART	TEMP RANGE	PIN-PACKAGE
MAX9381ESA	-40°C to +85°C	8 SO
MAX9381EUA*	-40°C to +85°C	8 μ MAX

*Future product—contact factory for availability.

Functional Diagram

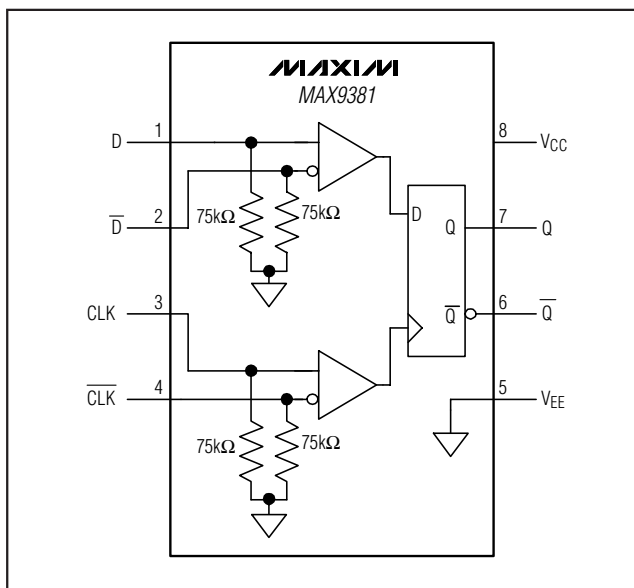

Pin Configuration

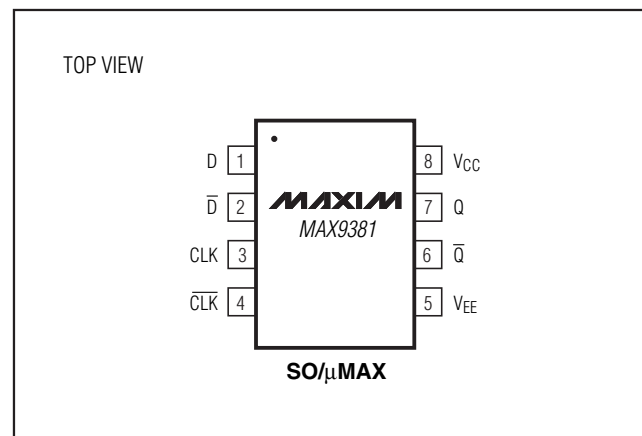
**MAXIM**

Maxim Integrated Products 1

For pricing, delivery, and ordering information, please contact Maxim/Dallas Direct! at 1-888-629-4642, or visit Maxim's website at www.maxim-ic.com.

Lowest Power 3.0GHz ECL/PECL Differential Data and Clock D Flip-Flop

ABSOLUTE MAXIMUM RATINGS

V _{CC} - V _{EE}	-0.3V to +6.0V	Junction-to-Ambient Thermal Resistance with 500LFPM Airflow	
Input Voltage (D, \bar{D} , CLK, \bar{CLK})	(V _{EE} - 0.3V) to (V _{CC} + 0.3V)	8-Pin μ MAX	+155°C/W
Differential Input Voltage	Smaller of IV _{CC} - V _{EE1} or 3.0V	8-Pin SO	+99°C/W
Output Current (Q, \bar{Q})		Junction-to-Case Thermal Resistance	
Continuous	50mA	8-Pin μ MAX	+39°C/W
Surge	100mA	8-Pin SO	+40°C/W
Junction-to-Ambient Thermal Resistance in Still Air		Operating Temperature Range	-40°C to +85°C
8-Pin μ MAX	+221°C/W	Junction Temperature	+150°C
8-Pin SO	+170°C/W	Storage Temperature Range	-65°C to +150°C
Maximum Continuous Power Dissipation		ESD Protection	
8-Pin μ MAX (derate 4.5mW/°C above +70°C)	362mW	Human Body Model	±2kV
8-Pin SO (derate 5.9mW/°C above +70°C)	471mW	Soldering Temperature (10s)	+300°C

Stresses beyond those listed under "Absolute Maximum Ratings" may cause permanent damage to the device. These are stress ratings only, and functional operation of the device at these or any other conditions beyond those indicated in the operational sections of the specifications is not implied. Exposure to absolute maximum rating conditions for extended periods may affect device reliability.

DC ELECTRICAL CHARACTERISTICS

(V_{CC} - V_{EE} = 2.25V to 5.5V (T_A = +25°C to +85°C), V_{CC} - V_{EE} = 2.375V to 5.5V (T_A = -40°C to +25°C), outputs terminated with 50 Ω \pm 1% to V_{CC} - 2.0V, unless otherwise noted. Typical values are at V_{CC} - V_{EE} = 3.3V, V_{IHD} = V_{CC} - 1.0V, V_{ILD} = V_{CC} - 1.5V, unless otherwise noted.) (Notes 1, 2, and 3)

PARAMETER	SYMBOL	CONDITIONS	-40°C			+25°C			+85°C			UNITS
			MIN	TYP	MAX	MIN	TYP	MAX	MIN	TYP	MAX	
INPUTS (D, \bar{D}, CLK, \bar{CLK})												
Differential Input High Voltage	V _{IHD}	Figure 1	V _{EE} + 1.2	V _{CC}	V _{EE} + 1.2	V _{CC}	V _{EE} + 1.2	V _{CC}	V _{EE} + 1.2	V _{CC}	V	
Differential Input Low Voltage	V _{ILD}	Figure 1	V _{EE}	V _{CC} - 0.15	V _{EE}	V _{CC} - 0.15	V _{EE}	V _{CC} - 0.15	V _{EE}	V _{CC} - 0.15	V	
Differential Input Voltage	V _{ID}	Figure 1	V _{CC} - V _{EE} < 3.0V	V _{CC} - V _{EE}	0.15	V _{CC} - V _{EE}	0.15	V _{CC} - V _{EE}	0.15	V _{CC} - V _{EE}	V	
			V _{CC} - V _{EE} \geq 3.0V	3.0	0.15	3.0	0.15	3.0	0.15	3.0		
Single-Ended Input Current	I _{IH} , I _{IL}	D, \bar{D} , CLK, or \bar{CLK} = V _{IHD} or V _{ILD}	-10	+200	-10	+200	-10	+200	-10	+200	μ A	
OUTPUTS (Q, \bar{Q})												
Output High Voltage	V _{OH}	Figure 1	V _{CC} - 1.145	V _{CC} - 0.895	V _{CC} - 1.145	V _{CC} - 0.895	V _{CC} - 1.145	V _{CC} - 0.895	V _{CC} - 1.145	V _{CC} - 0.895	V	
Output Low Voltage	V _{OL}	Figure 1	V _{CC} - 1.945	V _{CC} - 1.695	V _{CC} - 1.945	V _{CC} - 1.695	V _{CC} - 1.945	V _{CC} - 1.695	V _{CC} - 1.945	V _{CC} - 1.695	V	
Differential Output Voltage	V _{OD}	V _{OH} - V _{OL} , Figure 1	550		550		550		550		mV	
POWER SUPPLY												
Power-Supply Current (Note 4)	I _{EE}		17	35	20	35	22	35			mA	

Lowest Power 3.0GHz ECL/PECL Differential Data and Clock D Flip-Flop

MAX9381

AC ELECTRICAL CHARACTERISTICS

($V_{CC} - V_{EE} = 2.25V$ to $5.5V$ ($T_A = +25^{\circ}C$ to $+85^{\circ}C$), $V_{CC} - V_{EE} = 2.375V$ to $5.5V$ ($T_A = -40^{\circ}C$ to $+25^{\circ}C$), outputs terminated with $50\Omega \pm 1\%$ to $V_{CC} - 2.0V$, $f_{CLK} \leq 3.0GHz$, input transition time = $125ps$ (20% to 80%), $V_{IHD} = V_{EE} + 1.2V$ to V_{CC} , $V_{ILD} = V_{EE}$ to $V_{CC} - 0.15V$, $V_{IHD} - V_{ILD} = 0.15V$ to smaller of $|V_{CC} - V_{EE}|$ or $3V$, unless otherwise noted. Typical values are at $V_{CC} - V_{EE} = 3.3V$, $V_{IHD} = V_{CC} - 1.0V$, $V_{ILD} = V_{CC} - 1.5V$, unless otherwise noted.) (Notes 1, 5)

PARAMETER	SYMBOL	CONDITIONS	-40°C			+25°C			+85°C			UNITS
			MIN	TYP	MAX	MIN	TYP	MAX	MIN	TYP	MAX	
Propagation Delay CLK, \overline{CLK} to Q, \overline{Q}	t_{PHL} t_{PLH}	Figure 2			370		328	405			490	ps
Maximum Clock Frequency	f_{CLKMAX}	$V_{OD} \geq 300mV$	3.0			3.0			3.0			GHz
Setup Time	t_S	Figure 2	100			100			100			ps
Hold Time	t_H	Figure 2	50			50			50			ps
Added Random Jitter (Note 6)	t_{RJ}			0.2	0.8		0.2	0.8		0.2	0.8	ps (RMS)
Differential Output Rise/Fall Time	t_{R}/t_{F}	20% to 80%, Figure 2	70	120	170	80	120	180	90	120	200	ps

Note 1: Measurements are made with the device in thermal equilibrium.

Note 2: Current into a pin is defined as positive. Current out of a pin is defined as negative.

Note 3: DC parameters are production tested at $+25^{\circ}C$. DC limits are guaranteed by design and characterization over the full operating temperature range.

Note 4: All pins floating except V_{CC} and V_{EE} .

Note 5: Guaranteed by design and characterization, and are not production tested. Limits are set to ± 6 sigma.

Note 6: Device jitter added to the input clock.

Lowest Power 3.0GHz ECL/PECL Differential Data and Clock D Flip-Flop

Typical Operating Characteristics

($V_{CC} - V_{EE} = 3.3V$, outputs loaded with $50\Omega \pm 1\%$ to $V_{CC} - 2V$, $V_{IH} = V_{CC} - 1V$, $V_{IL} = V_{CC} - 1.5V$, $f_{CLK} = 3GHz$, $f_D = f_{CLK}/2$ input transition time = 125ps (20% to 80%), unless otherwise noted.)

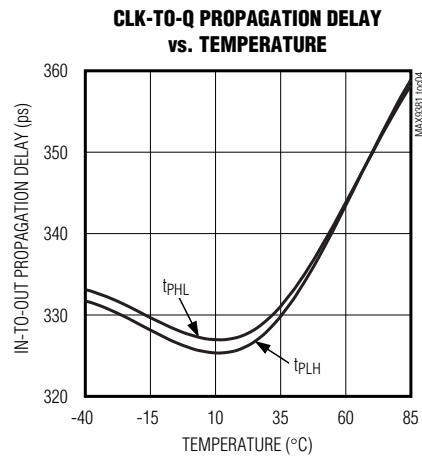
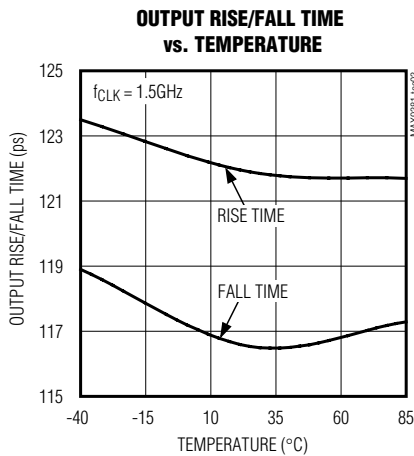
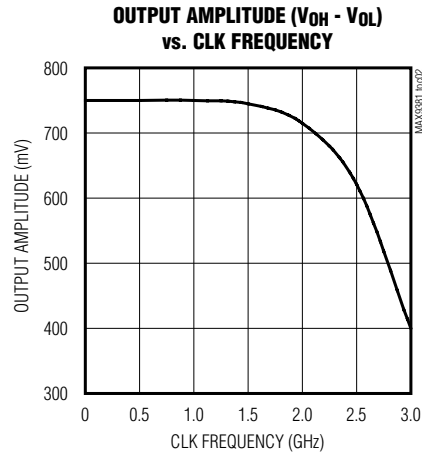
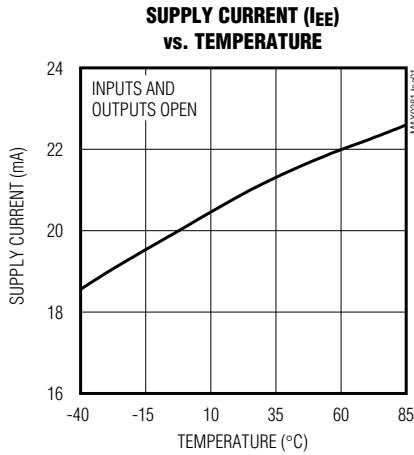

Lowest Power 3.0GHz ECL/PECL Differential Data and Clock D Flip-Flop

MAX9381

Pin Description

PIN	NAME	FUNCTION
1	D	Noninverting D Input to the Flip-Flop. Internally pulled down with a 75kΩ resistor to V _{EE} .
2	\overline{D}	Inverting D Input to the Flip-Flop. Internally pulled down with a 75kΩ resistor to V _{EE} .
3	CLK	Noninverting Clock Input to the Flip-Flop. Internally pulled down with a 75kΩ resistor to V _{EE} .
4	\overline{CLK}	Inverting Clock Input to the Flip-Flop. Internally pulled down with a 75kΩ resistor to V _{EE} .
5	V _{EE}	Negative Supply
6	\overline{Q}	Inverting Q Output from the Flip-Flop. Terminate with a 50Ω resistor to V _{CC} - 2V or equivalent.
7	Q	Noninverting Q Output from the Flip-Flop. Terminate with a 50Ω resistor to V _{CC} - 2V or equivalent.
8	V _{CC}	Positive Supply. Bypass from V _{CC} to V _{EE} with 0.1μF and 0.01μF ceramic capacitors. Place the capacitors as close to the device as possible with the smaller value capacitor closest to the device.

Detailed Description

The MAX9381 D flip-flop transfers the logic level at the D input to the Q output on a rising edge transition of the clock, provided the minimum setup and hold times are met. By interchanging the CLK and \overline{CLK} inputs, the flip-flop functions as a falling-edge triggered flip-flop.

The input signals (D, \overline{D} and CLK, \overline{CLK}) are differential and have a maximum differential input voltage of 3.0V or V_{CC} - V_{EE}, whichever is less. To ensure that the outputs remain stable when the inputs are left open, each of the inputs is driven low by a 75kΩ bias resistor connected to V_{EE}. If the D and \overline{D} inputs are left open or at V_{EE}, the output is guaranteed to be a differential low on the next low-to-high transition of the clock. If the CLK and \overline{CLK} inputs are left open or at V_{EE}, the outputs remain unchanged (Table 1). Terminate the outputs (Q, \overline{Q}) through 50Ω to V_{CC} - 2V or an equivalent Thevenin termination (see the *Output Termination* section).

ECL/PECL Operation

Output levels are referenced to V_{CC} and are considered PECL or ECL, depending on the level of the V_{CC}

Table 1. Truth Table*

D, \overline{D}	CLK, \overline{CLK}	Q, \overline{Q}
L	↑	L
H	↑	H
Open or V _{EE}	↑	L
X	Open or V _{EE}	No change

*Where logic states are differential, ↑ is a low-to-high transition and X signifies a don't care state.

supply. With V_{CC} connected to a positive supply and V_{EE} connected to GND, the outputs are PECL. The outputs are ECL when V_{CC} is connected to GND and V_{EE} is connected to a negative supply.

Applications Information

T Flip-Flop

The MAX9381 can be configured as a T flip-flop by connecting Q to \overline{D} and \overline{Q} to D. This configuration provides an output at half the frequency of the clock. The maximum operating frequency is determined by the sum of the setup time, the propagation delay of the

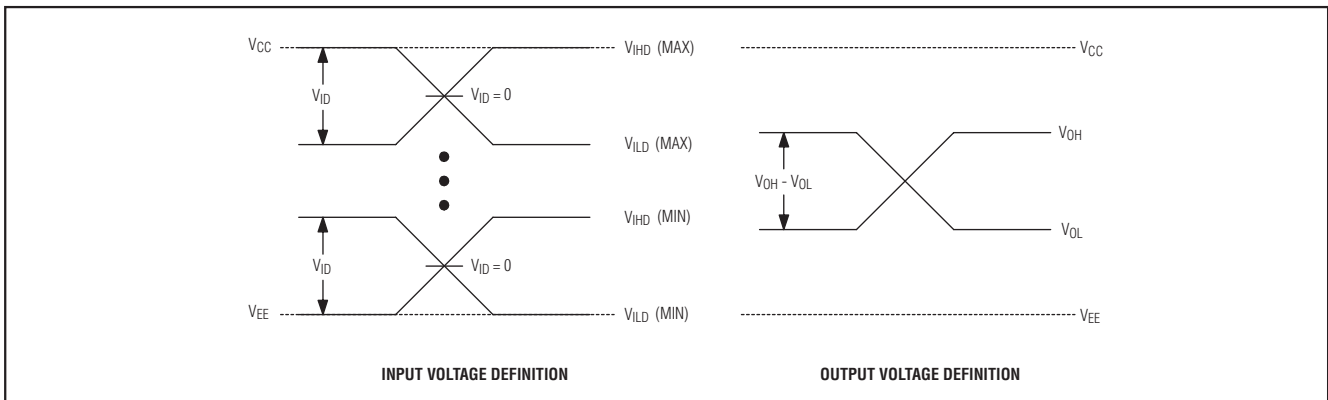

Figure 1. Input and Output Voltage Definitions

Lowest Power 3.0GHz ECL/PECL Differential Data and Clock D Flip-Flop

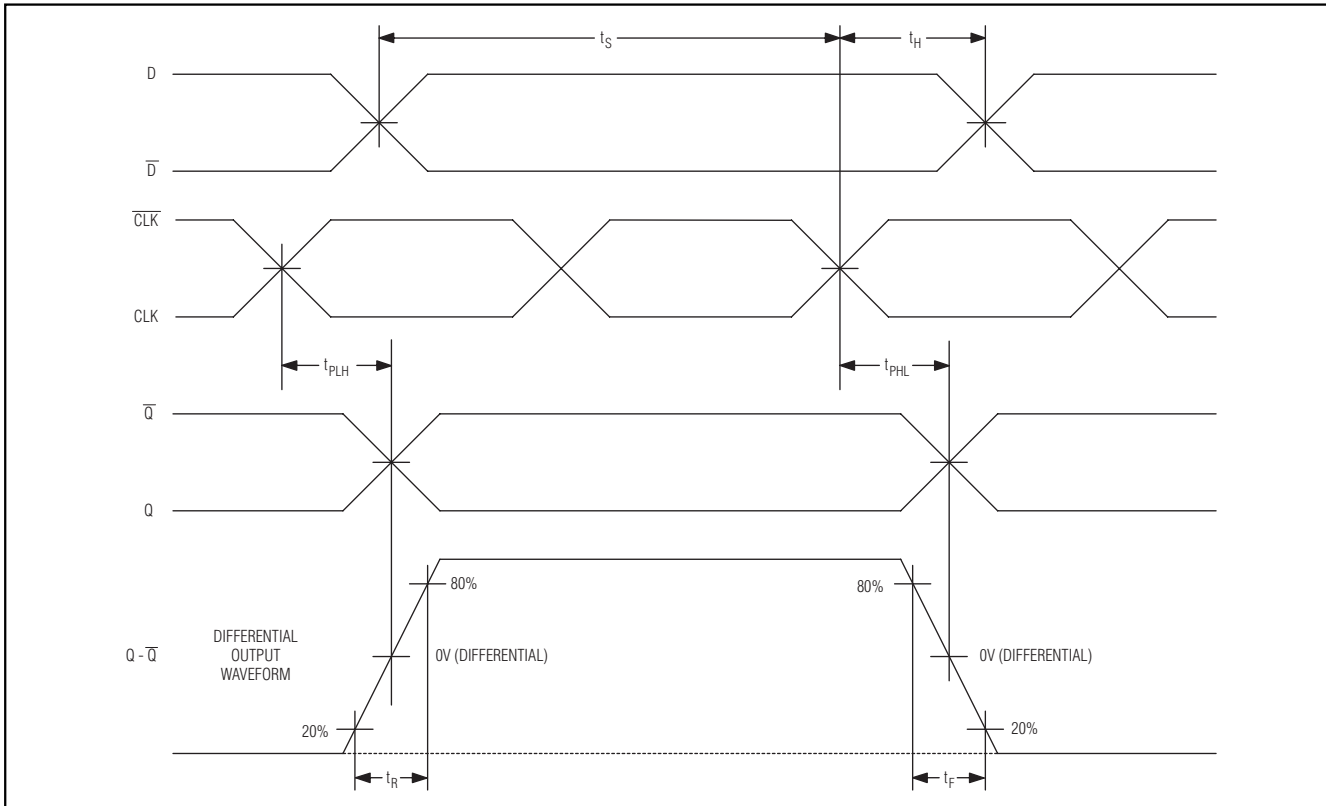

Figure 2. CLK-to-Q Propagation Delay and Transition Timing Diagram

device and any added delay by circuit board traces. The minimum supply voltage is 2.375V and is determined by input and output voltage range.

Output Termination

Terminate the outputs through 50Ω to $V_{CC} - 2V$ or use equivalent Thevenin terminations. Terminate each Q and \bar{Q} outputs with identical termination on each for the lowest output distortion. When a single-ended signal is taken from the differential output, terminate both Q and \bar{Q} .

Ensure that output currents do not exceed the current limits as specified in the *Absolute Maximum Ratings* table. Under all operating conditions, the device's total thermal limits should be observed.

Power-Supply Bypassing

Bypass V_{CC} to V_{EE} with high-frequency surface-mount ceramic $0.1\mu F$ and $0.01\mu F$ capacitors. Place the capacitors as close to the device as possible with the $0.01\mu F$ capacitor closest to the device pins.

Use multiple vias when connecting the bypass capacitors to ground. This reduces trace inductance, which lowers power-supply bounce when drawing high transient currents.

Circuit Board Traces

Circuit board trace layout is very important to maintain the signal integrity of high-speed differential signals. Maintaining integrity is accomplished in part by reducing signal reflections and skew, and increasing common-mode noise immunity.

Signal reflections are caused by discontinuities in the 50Ω characteristic impedance of the traces. Avoid discontinuities by maintaining the distance between differential traces, not using sharp corners, or using vias. Maintaining distance between the traces also increases common-mode noise immunity. Reducing signal skew is accomplished by matching the electrical length of the differential traces.

Chip Information

TRANSISTOR COUNT: 375

PROCESS: Bipolar