

MAX96706/MAX96708 Evaluation Kit

Evaluates: MAX96706/MAX96708 with Coax or STP Cable

General Description

The MAX96706/MAX96708 evaluation kit (EV kit) provides a proven design to evaluate the MAX96706 and MAX96708 high-bandwidth gigabit multimedia serial link (GMSL) deserializers with spread spectrum and full-duplex control channel, through the use of a standard FAKRA coax or STP cable. The EV kit also includes Windows Vista®- and Windows 7-compatible software that provides a simple graphical user interface (GUI) for exercising features of the device. The EV kit comes with a MAX96706GTJ+ or MAX96708GTJ+ IC installed.

For complete GMSL evaluation, using a standard FAKRA coaxial cable, order the MAX96706 or MAX96708 EV kit and a companion serializer board (e.g., the MAX96705 or MAX96711 EV kit, referenced in this document). For testing with STP cable, also order the MAXCOAX2STP-HSD adapter kit and refer to its data sheet. Only one adapter kit is required per link (connecting the serializer and deserializer boards).

Note: In the following sections, MAX96706/708 and the term “deserializer” refer to the MAX96706 or MAX96708 IC and MAX96705/711 and the term “serializer” refer to the MAX96705 or MAX96711 IC.

Note: This document applies to both coax and STP EV kits. This document covers coax cables, but the information provided applies equally to STP cables.

Features

- Accepts GMSL Serial Data through FAKRA Connectors as Inputs and Outputs 16-Bit Parallel Output Data
- Power Over Coax (POC) Capable
- Windows Vista- and Windows 7-Compatible Software
- USB-Controlled Interface (Cable Included)
- USB Powered
- Proven PCB Layout
- Fully Assembled and Tested

Items included in the Evaluation Kit Package

ITEM DESCRIPTION	QTY
MAX96706 or MAX96708 coax EV kit board	1
2m FAKRA cable assembly	1
USB cable	1

MAX96706/MAX96708 EV Kit Files

FILE	DESCRIPTION
MAXSerDesEV-N_Vxxxx_Install.EXE	Installs the EV kit files on your computer
MAXSerDesEV-N.EXE	Graphical user interface (GUI) program
CDM20600.EXE	Installs the USB device driver
USB_Driver_Help_200.PDF	USB driver installation help file

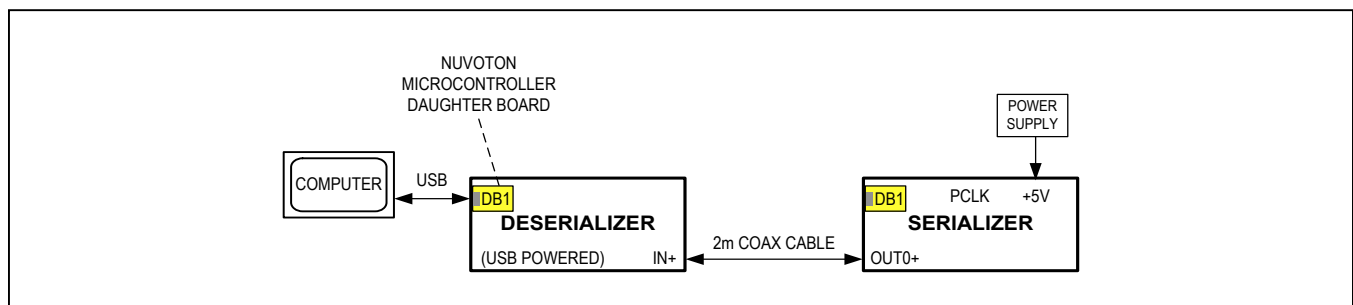

Figure 1. Deserializer Test Setup Block Diagram

Windows and Windows Vista are registered trademarks and registered service marks of Microsoft Corporation.

Ordering Information appears at end of data sheet.

Quick Start

Required Equipment

- MAX96706 or MAX96708 EV kit
- MAX96705 or MAX96711 EV kit
- 2m FAKRA cable assembly (included in the MAX96706 and MAX96708 EV kits)
- > 20MHz function generator (optional)
- PC with Windows Vista or Windows 7 and a spare USB port (direct 500mA connection required; do not use a bus-powered hub)
- Ammeter
- 500mA, 5V DC power supply

Note: In the following sections, software-related items are identified by bolding. Text in **bold** refers to items from the EV kit software. Text in **bold and underlined** refers to items from the Windows operating system.

Procedure

The EV kit is fully assembled and tested. Follow the steps below to verify board operation:

- 1) Visit www.maximintegrated.com/EVKitsoftware to download and install the latest version of the software, and then do the following:
 - Double-click on GMSL SerDes Evaluation Kit Software-Nuvoton µC.
 - Download the MAXSerDesEV-N_Vx_x_x_x_Install.ZIP file (8MB).
 - Extract and install the MAXSerDesEV-N_Vx_x_x_x_Install.EXE file. The installation application will install the USB driver. If the USB driver installation was not successful, install the appropriate USB driver for your computer by visiting www.ftdichip.com/Drivers/VCP.htm.
- 2) Verify that jumpers on the serializer board are in their default positions, as shown in [Figure 15](#).
- 3) Verify that jumpers on the deserializer board are in their default positions, as shown in [Figure 16](#).
- 4) Set up the system, as shown in [Figure 1](#).
- 5) Connect the FAKRA cable from the OUT+ terminal on the serializer board to the IN0+ terminal on the deserializer board.
- 6) Connect the USB cable between the PC and USB port on the Nuvoton microcontroller daughter board on the deserializer board.
- 7) Connect the power supply to the +5VIN/GND terminals on the serializer board.
- 8) Turn on the power supply.
- 9) Verify that LED_PWR on the deserializer board lights up, indicating that the deserializer board has power.
- 10) Verify that LED_PWR on the serializer board lights up, indicating that the serializer board has power.
- 11) Verify that LOCK_LED on the deserializer EV board lights up, indicating that the link has been successfully established. If LOCK_LED is off, go to the [Troubleshooting](#) section at the end of this document and fix the problem before continuing..
- 12) Start the EV kit software by selecting **Start | Programs | Maxim Integrated | MAXSerDesEV-N | MAXSerDesEV-N**.
- 13) The **Configuration Settings** window opens (see [Figure 2](#)) and the GUI automatically searches for any active listener in both I²C and UART mode and identifies a valid GMSL product. Once a valid device is identified, the corresponding configuration jumpers are displayed to help the user configure the serializer and deserializer.
- 14) In case an operating evaluation board with a Nuvoton microcontroller is not found, a window appears ([Figure 3](#)) warning as such. Press **OK** to continue and start the GUI anyway, or press **Cancel** to terminate the application. Go to the [Troubleshooting](#) section at the end of this document and fix the problem before continuing.
- 15) When an operating Nuvoton microcontroller is found, the GUI checks the firmware version in the microcontroller and prompts the user to update ([Figure 4](#)).
- 16) While the **Configuration Settings** window is open, press the **Identify Devices** button to search for the devices connected.

Only **Link Type** and **Device Address** selections on the **Configuration Settings** window affect the EV kit operation. Other items are for user reference only.
- 17) Press the **Connect** button to open the **Evaluation Kit** window and devices under test (DUT) register maps ([Figure 5](#)). The GUI will read all internal registers of the serializer and deserializer and update the corresponding tabs.
- 18) Press the **Read All** button in the **Serializer** group box to read all the serializer registers.
- 19) Press the **MAX96706 Des** tab and then press the **Read All** button in the **Deserializer** group box to read all the deserializer registers.
- 20) Select any of the other tabs to evaluate other serializer/deserializer (SerDes) functions.

Table 1. Jumper Descriptions*

JUMPER	SIGNAL	DEFAULT POSITION	FUNCTION
J4	IN0+	—	GMSL IN1+ FAKRA connector
J5	IN0-	—	GMSL IN1- FAKRA connector
J6	POC1+	5VOUT	5V POC sourced by the serializer
		5VIN	5V POC expected from the deserializer
		12V	12V POC can be applied by either serializer or deserializer
		Open*	POC disabled
J7	POC1-	5VOUT	5V POC sourced by the serializer
		5VIN	5V POC expected from the deserializer
		12V	12V POC can be applied by either the serializer or deserializer
		Open*	POC disabled
J8	POC0+	5VOUT	5V POC sourced by the serializer
		5VIN	5V POC expected from the deserializer
		12V	12V POC can be applied by either the serializer or deserializer
		Open*	POC disabled
J9	POC0-	5VOUT	5V POC sourced by the serializer
		5VIN	5V POC expected from the deserializer
		12V	12V POC can be applied by either the serializer or deserializer
		Open*	POC disabled
J10	LFL1+	Short*	Line fault monitored by the local device on the IN1+ terminal (LFLTVDD must be short; LFR1+, LFR1-, LFL1- must be open)
		Open	Line fault not monitored by IN1+
J11	LFR1+	Short	Line fault monitored by the remote device on the OUT+ terminal (LFLTVDD must be short; LFR1-, LFL1+, LFL1- must be open)
		Open*	Line fault can be monitored by local device, but not remote device
J12	LFL1-	Short	Line fault monitored by the local device on the IN1- terminal (LFLTVDD must be short; LFR1+, LFL1-, LFL1+ must be open)
		Open*	Line fault not monitored by IN1-
J13	LFR1-	Short	Line fault monitored by the remote device on the OUT- terminal (LFLTVDD must be short; LFR1+, LFL1+, LFL1- must be open)
		Open*	Line fault can be monitored by local device, but not remote device
J14	LFLTVDD	Short*	Line-fault circuit powered, connected to AVDD
		Open	Line-fault circuit powered, nonfunctional
J15	LFL0+	Short*	Line fault monitored by the local device on the IN0+ terminal (LFLTVDD must be short; LFR0+, LFR0-, LFL0- must be open)
		Open	Line fault not monitored by IN0+

Table 1. Jumper Descriptions* (continued)

JUMPER	SIGNAL	DEFAULT POSITION	FUNCTION
J16	LFR0+	Short	Line fault monitored by the remote device on the OUT+ terminal (LFLTVDD must be short; LFR0-, LFL0+, LFL0- must be open)
		Open*	Line fault can be monitored by local device, but not remote device
J17	LFL0-	Short	Line fault monitored by the local device on the IN0- terminal (LFLTVDD must be short; LFR0+, LFR0-, LFL0+ must be open)
		Open*	Line fault not monitored by IN0-
J21	LFR0-	Short	Line fault monitored by the remote device on the OUT- terminal (LFLTVDD must be short. LFR0+, LFL0+, LFL0- must be open)
		Open*	Line fault can be monitored by local device, but not remote device
J22	EXT_RX/SDA, EXT_TX/SCL, GND, VDD_REF	—	4-pin header to apply user microcontroller
J23	LMN0	LMN0+	Line monitor on channel 0+
		LMN0-	Line monitor on channel 0+
		Open*	Not connected
J24	LMN1	LMN1+	Line monitor on channel 1+
		LMN1-	Line monitor on channel 0+
		Open*	Not connected
J25	ADD2	Short	ADD2 = 1
		Open*	ADD2 = 0
J26	HIM	Short	High-immunity mode
		Open*	Bypass mode
J27	ADD0	Short	ADD0 = 1
		Open*	ADD0 = 0
J28	ADD1	Short	ADD1 = 1
		Open*	ADD1 = 0
J30	ADD3	Short	ADD3 = 1
		Open*	ADD3 = 0
J31	I2CSEL	Short*	I ² C mode
		Open	UART mode
J32	IOVDD_DUT	Short*	IOVDD applied to U1
		Open	Apply ammeter to measure current drawn by U1 IOVDD
J33	GPI	L	U1 GPI pin shorted to GND
		H	U1 GPI pin pulled high
		Open*	Not connected

Table 1. Jumper Descriptions* (continued)

JUMPER	SIGNAL	DEFAULT POSITION	FUNCTION
J35	MS/HVEN	L	U1 MS/HVEN pin shorted to GND
		H	U1 MS/HVEN pin pulled high
		Open*	Not connected
J37	PWDN	Short*	U1 powered
		Open	U1 not powered
J39	TX_SCL	TX	U1 TX/SCL pin connected to μ C RX pin
		SCL*	U1 TX/SCL pin connected to μ C SDA pin
		Open	U1 TX/SCL pin left open
J40	RX_SDA	RX	U1 RX/SDA pin connected to μ C RX pin
		SDA*	U1 RX/SDA pin connected to μ C SDA pin
		Open	U1 RX/SDA pin left open
J41	IN0+	—	GMSL IN0+ FAKRA connector
J42	SCLPU	Short*	SCL is pulled up
		Open	SCL is not pulled up
J43	IN0-	—	GMSL IN0- FAKRA connector
J44	SDAPU	Short*	SDA pulled up
		Open	SDA not pulled up
J45	SDAPU	Short*	SDA pulled up
		Open	SDA not pulled up
J46	SDAPU	Short*	SDA pulled up
		Open	SDA not pulled up
J47	U15 ch3	Open*	VLC3 = U15 level shifter, ch3 low side VLC4 = U15 level shifter, ch4 low side
J49	U15 ch4	Open*	VHC3 = U15 level shifter, ch3 high side VHC4 = U15 level shifter, ch4 high side
J50	MON+	—	SMA connector, MON output positive
J51	MON-	—	SMA connector, MON output negative
J53	EXSDAPU	Short*	On-board pullup applied on external μ C SDA signal
		Open	External μ C SDA signal must be pulled up externally
J54	EXSCLPU	Short*	On-board pullup applied on external μ C SCL signal
		Open	External μ C SCL signal must be pulled up externally

*Jumper selections in the **Serializer/Deserializer** group boxes on the **Configuration Settings** window are for reference only and do not affect software operation.

**Default position.

Detailed Description of Software

To start the serializer evaluation kit GUI, select **Start | All Programs | Maxim Integrated | MAXSerDesEV-N | MAXSerDesEV-N**.

Configuration Settings Window

The **Configuration Settings** window is the first window that opens after successful program launch. It allows the user to specify serializer and deserializer board setup and mode of operation (Figure 2).

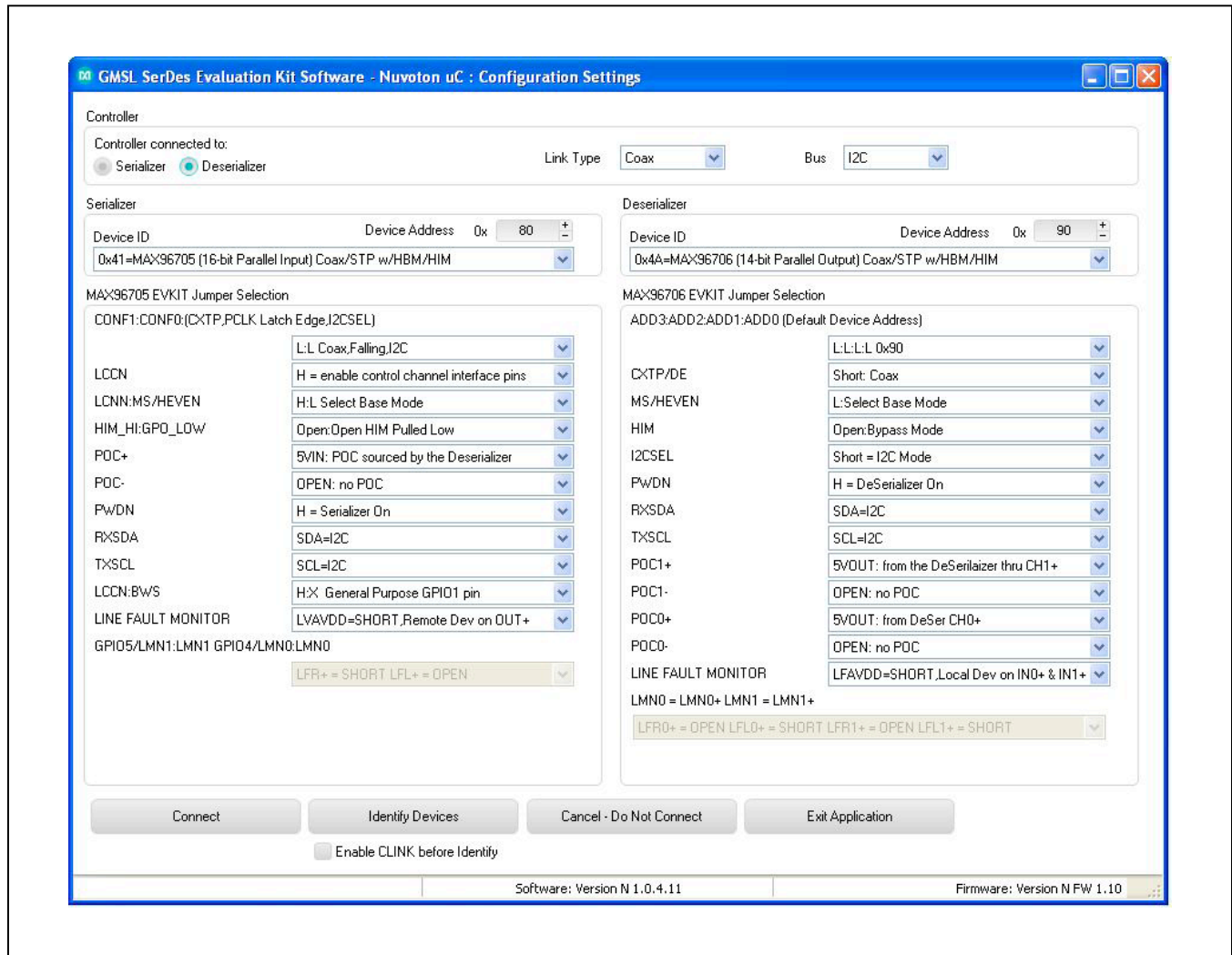

Figure 2. MAXSerDesEV-N EV Kit Software: Configuration Settings Window (shown with the MAX96705 and MAX96706 EV Kits Connected)

Controller Group Box

In the **Controller** group box, select **Coax** or **STP** from the **Link Type** drop-down list, **I2C** or **UART** from the **Bus** drop-down list, and whether the **Serializer** or **Deserializer** should be connected to the USB controller. Upon changing any of these parameters, conflicting jumper

settings will be highlighted, guiding the user to check and make the corresponding changes on the evaluation boards. Only **Link Type** and **Device Address** selections on the **Configuration Settings** window affect EV kit operation. Other items, including jumper selections, are for user reference only.

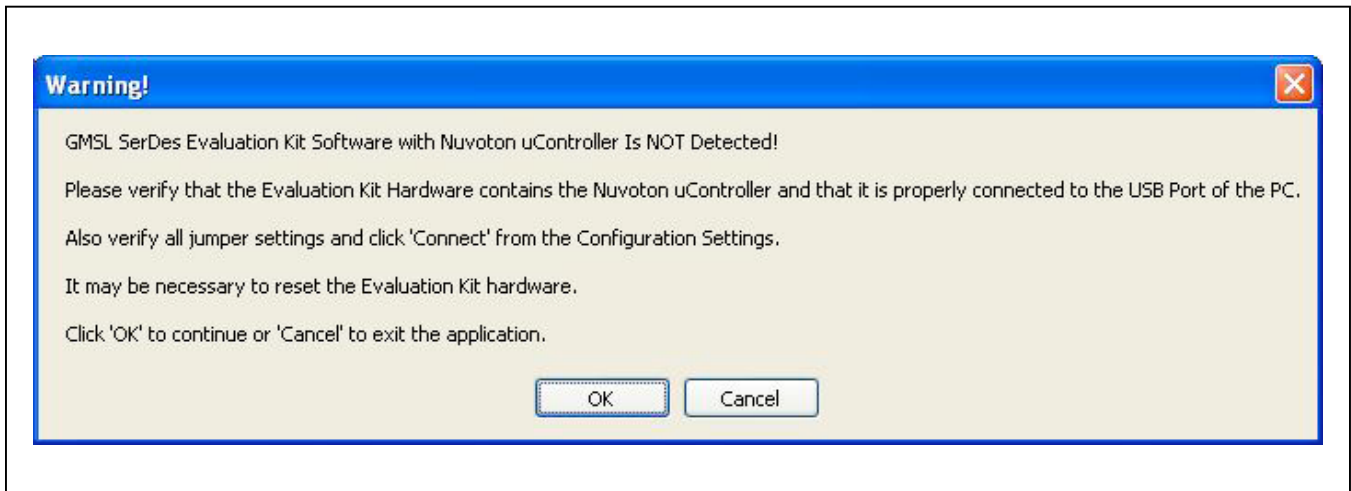

Figure 3. MAXSerDesEV-N EV Kit Software: Warning! Nuvoton μ Controller is not Detected.

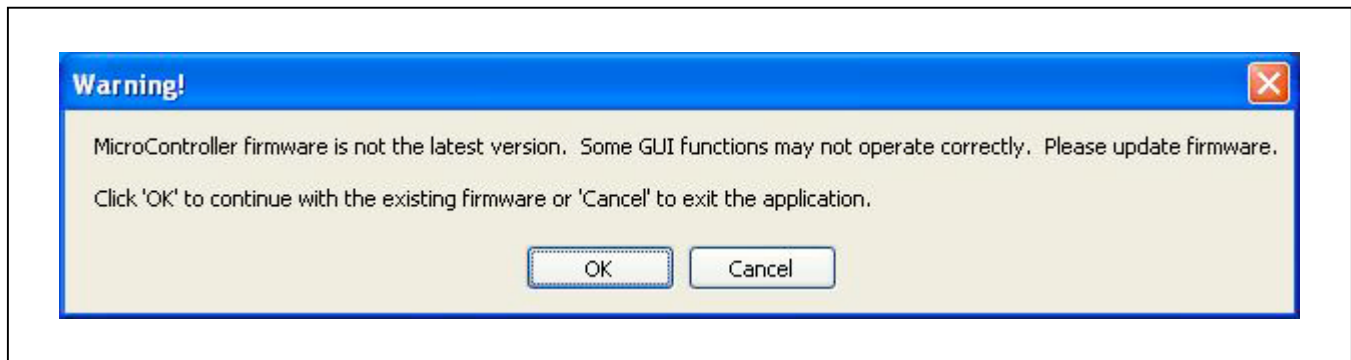

Figure 4. MAXSerDesEV-N EV Kit Software: Warning! Microcontroller Firmware is Not the Latest Version

Serializer and Deserializer Jumper Selection Blocks

The **Serializer** and **Deserializer Jumper Selection** blocks list jumpers on the evaluation boards of the selected **Device ID** and displays the correct shunt positions based on the conditions selected in the **Controller** blocks.

Identify Devices Button

The **Identify Devices** buttons causes the GUI to scan the system and hunt for slave addresses on the bus. Upon successful communication, it reads the **Device ID** register from the DUTs and displays the corresponding jumper lists on the **Serializer** and **Deserializer Jumper Selection** blocks. It is also possible to select a device from the **Device ID** drop-down list and manually change the slave address in the **Device Address** edit box. It is a good practice to utilize the **Identify Devices** button and verify communication with the DUTs before attempting to **Connect**.

[Figure 15](#) and [Figure 16](#) show jumper settings on the serializer and deserializer PCBs for coax cable and I²C communication with the USB controller connected to the deserializer board. Refer to the respective IC data sheets for detailed configuration information. See [Table 1](#) for PCB jumper descriptions.

Connect Button

The **Connect** button opens the **Evaluation Kit** window. The GUI reads the serializer and deserializer registers and updates the register maps for both. Successful register map updates are indicated by green LED indicators. In case of a communication problem, the LED indicators turn red.

Cancel - Do Not Connect Button

The **Cancel - Do not Connect** button opens the **Evaluation Kit** window without attempting to connect to the on-board microcontroller. Although there will be no communication with the microcontroller, all functions and tabs corresponding to the selected **Device IDs** become active once there.

Evaluation Kit Window

The **Evaluation Kit** window shown in [Figure 5](#) provides access to all internal registers and functions of the DUTs by means of reading and writing registers through different tabs to allow the user to evaluate various functions of the serializer and deserializer.

The **Read All** button updates the serializer and deserializer register maps by reading the DUTs' internal registers.

The **Serializer** group box provides pushbuttons to update the serializer's register maps. The **Read All** button reads register contents from the serializer and updates the displayed register values. The **Load** button reads and updates registers from a previously saved register map. The **Save** button saves the existing register values into a new file.

The **Deserializer** group box provides pushbuttons to update the deserializer's registers. The **Read All** button reads register contents from the deserializer and updates the displayed register values. The **Load** button reads and updates registers from a previously saved register map. The **Save** button saves the existing register values into a new file.

The **Wake Up** button applies the register write sequence described in the IC data sheets to wake up the DUTs from sleep mode.

The **Open Configuration** button returns to the **Configuration Settings** window. Use **Open Configuration** and **Connect** buttons to go back and forth between **Configuration Settings** window and **Evaluation Kit** window.

MAX96705 Ser Tab

The **MAX96705 Ser** tab (Figure 5) lists the serializer's registers bitmaps. The **Read** and **Write** buttons in each register group box allow read/write access for each bit or group of bits that specify a function or condition,

as defined in the respective serializer IC data sheet. The color of the small LED indicator next to the **Read/Write** buttons indicates the communication status. Green indicates successful communication and red indicates failed communication.

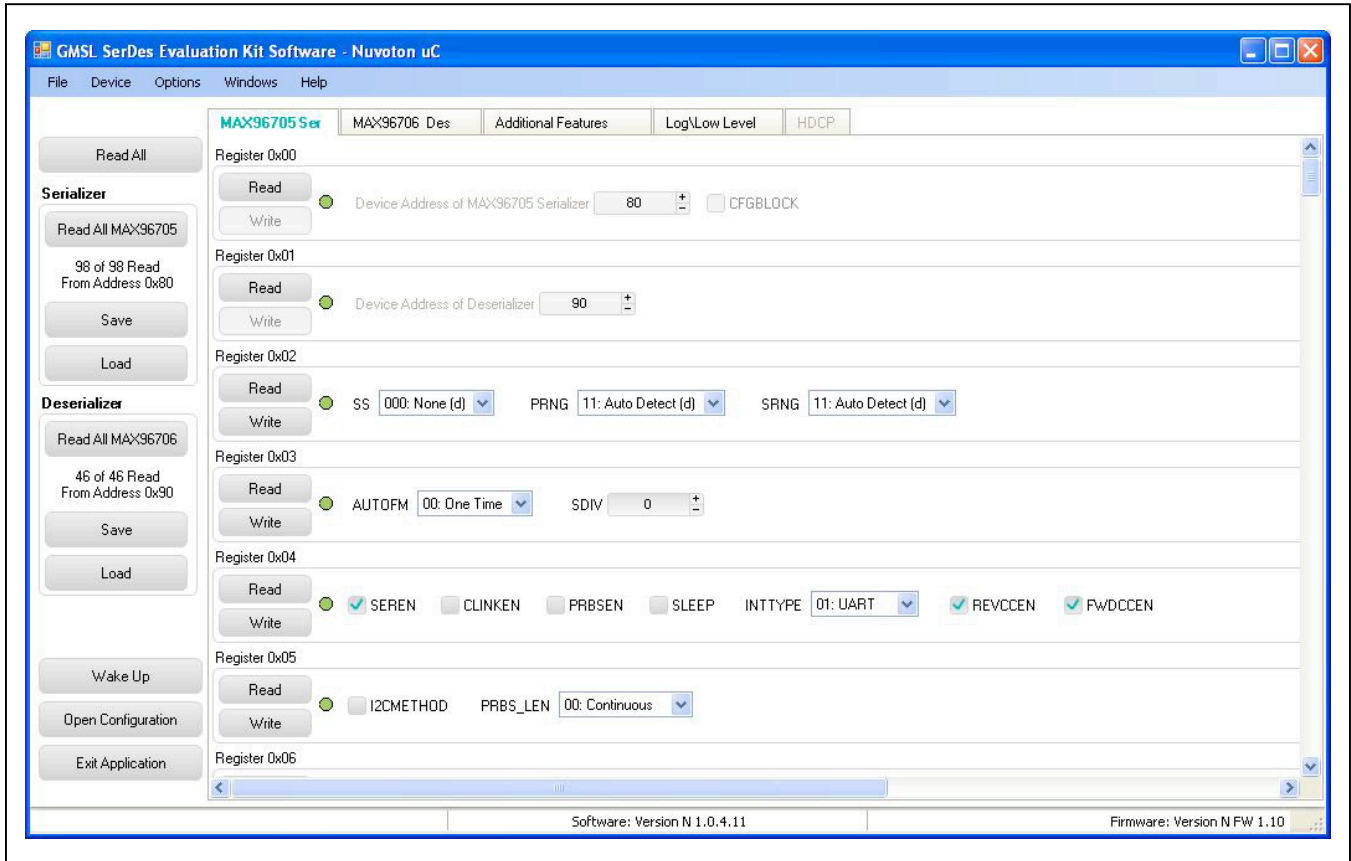

Figure 5. MAXSerDesEV-N EV Kit Software: Evaluation Kit Window (MAX96705 Ser Tab (Serializer))

MAX96706 Des Tab

The **MAX96705 Des** tab (Figure 6) lists the deserializer's registers bitmaps. The **Read** and **Write** buttons in each register group box allows read/write access for each bit or group of bits that specify a function or condition,

as defined in the respective deserializer IC data sheet. The color of the small LED indicator next to the **Read/Write** buttons indicates the communication status. Green indicates successful communication and red indicates failed communication.

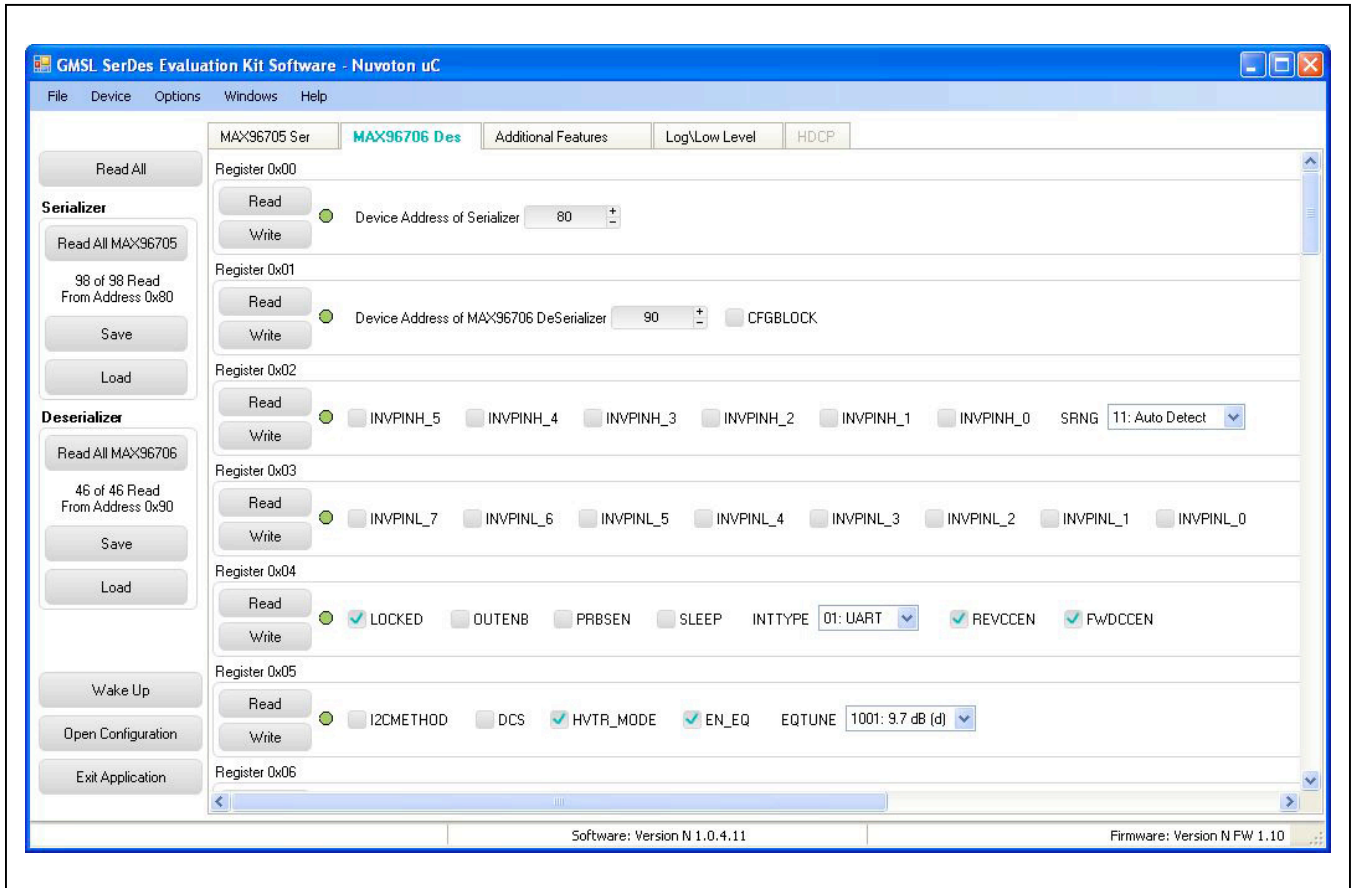

Figure 6. MAXSerDesEV-N EV Kit Software: Evaluation Kit Window (MAX96706 Des Tab (Deserializer))

Additional Features Tab

The **Additional Features** tab (Figure 7) provides push-buttons for specific functions that connected devices can

perform. By pressing a button, a window pops up and launches the specific function selected. Function buttons not supported by the selected device are grayed out.

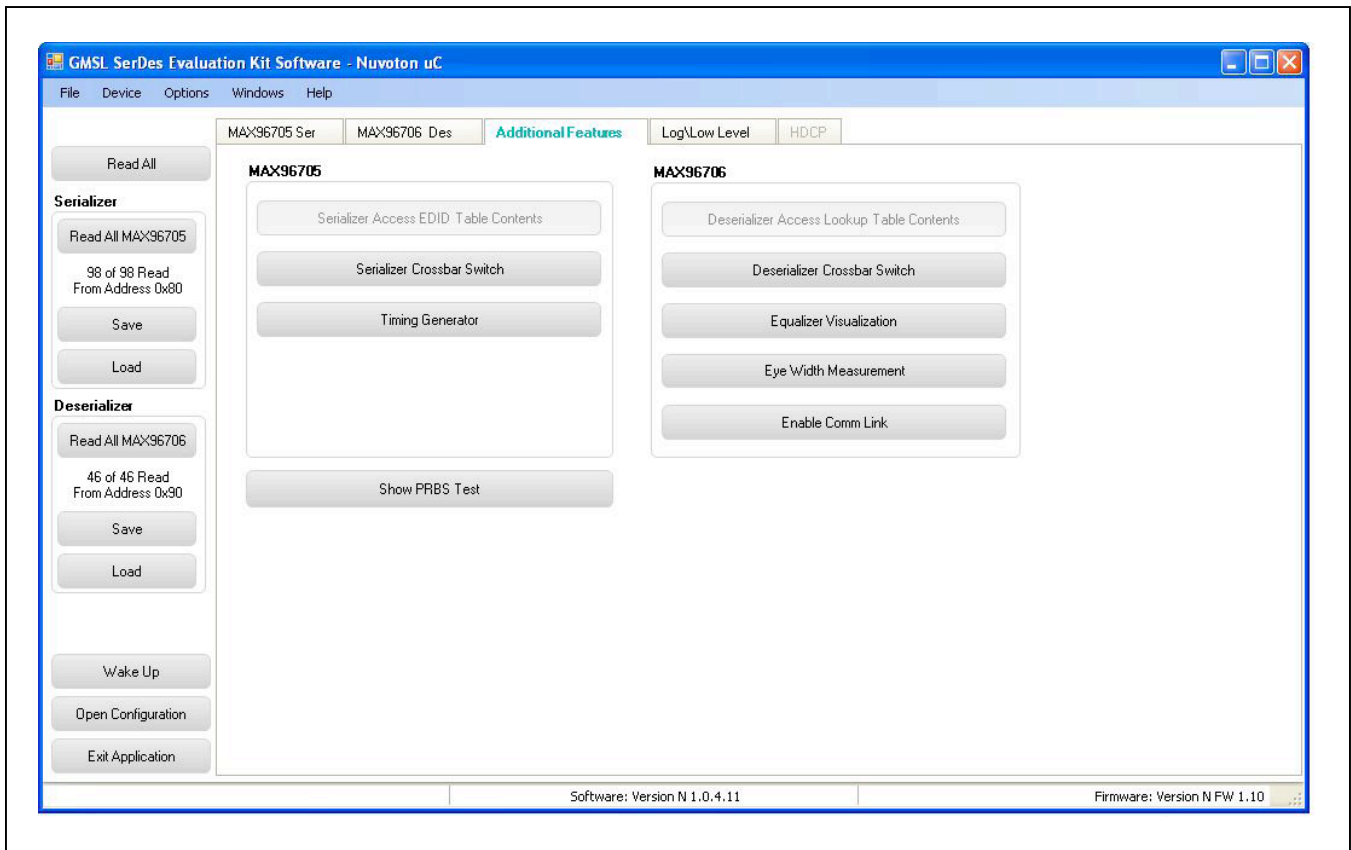

Figure 7. MAXSerDesEV-N EV Kit Software: Evaluation Kit Window (Additional Features Tab)

On the **Additional Features** tab, press the **Serializer Crossbar Switch** button to launch the **Serializer Crossbar Switch Configuration** window (Figure 8). This capability allows rearranging of data lines between the

parallel input and output by the serializer. Refer to the respective IC data sheet for a detailed description and operation of the embedded crossbar switches.

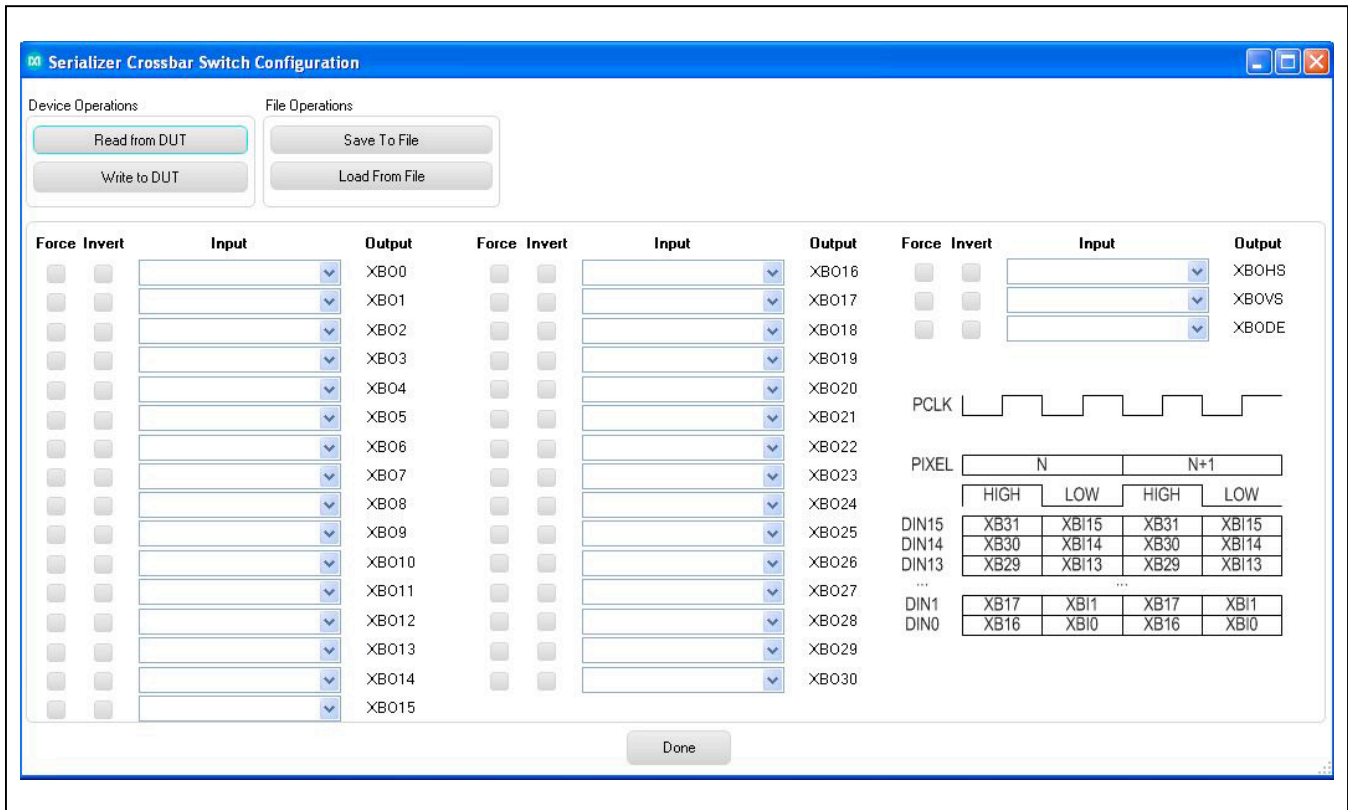

Figure 8. MAXSerDesEV-N EV Kit Software: Evaluation Kit Window (Serializer Crossbar Switch Configuration Window)

On the **Additional Features** tab, press the **Deserializer Crossbar Switch** button to launch the **Deserializer Crossbar Switch Configuration** window (Figure 9). This capability allows rearranging of data lines between the

parallel input and output by the deserializer. Refer to the IC respective data sheet for a detailed description and operation of the embedded crossbar switches.

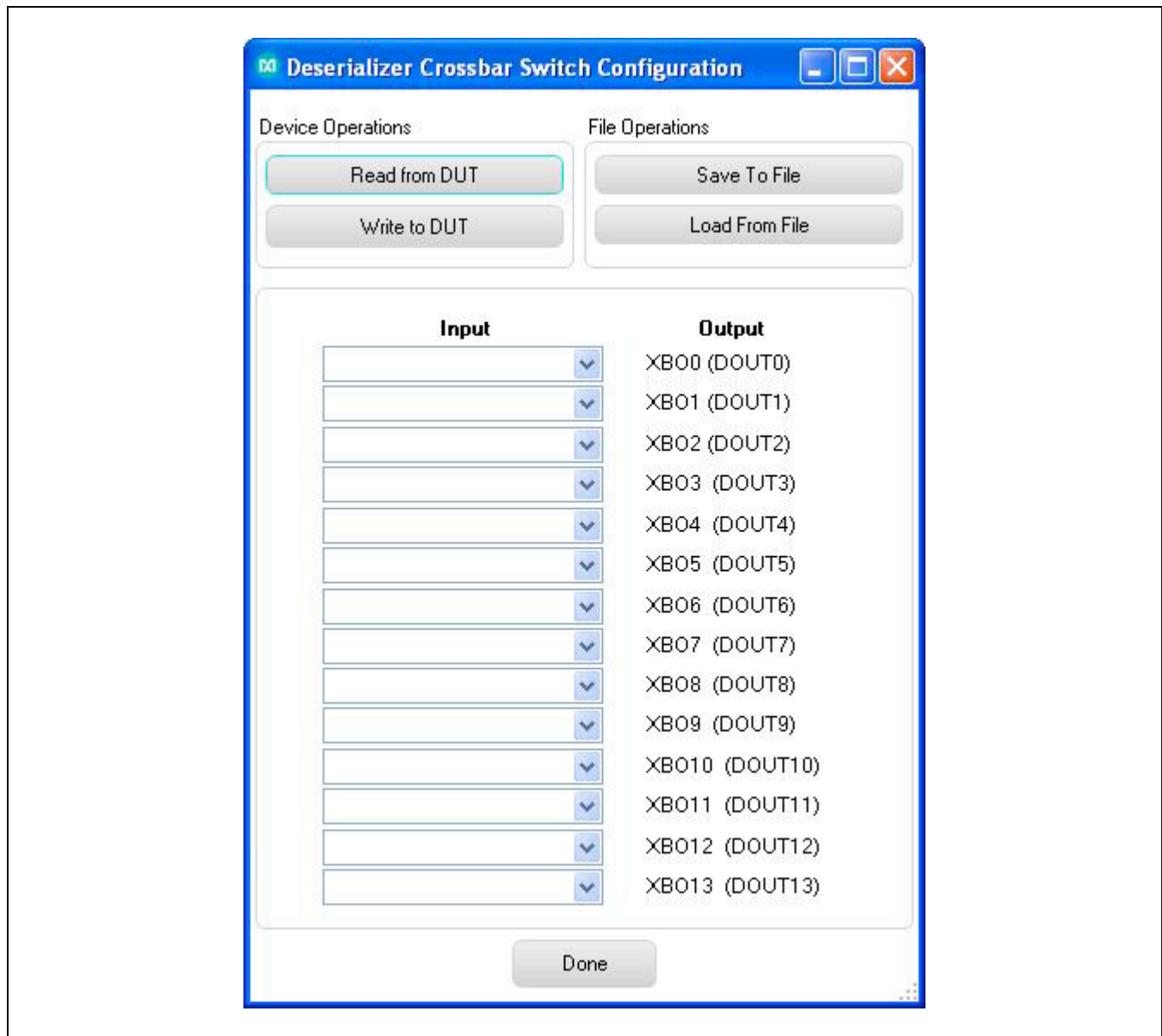

Figure 9. MAXSerDesEV-N EV Kit Software: Evaluation Kit Window (Deserializer Crossbar Switch Configuration Window)

On the **Additional Features** tab, press the **Timing Generator** button to launch this function (Figure 10), which allows the user to utilize the programmable video

timing generator to generate/retime the input sync signals. Refer to the respective IC data sheet for a detailed description.

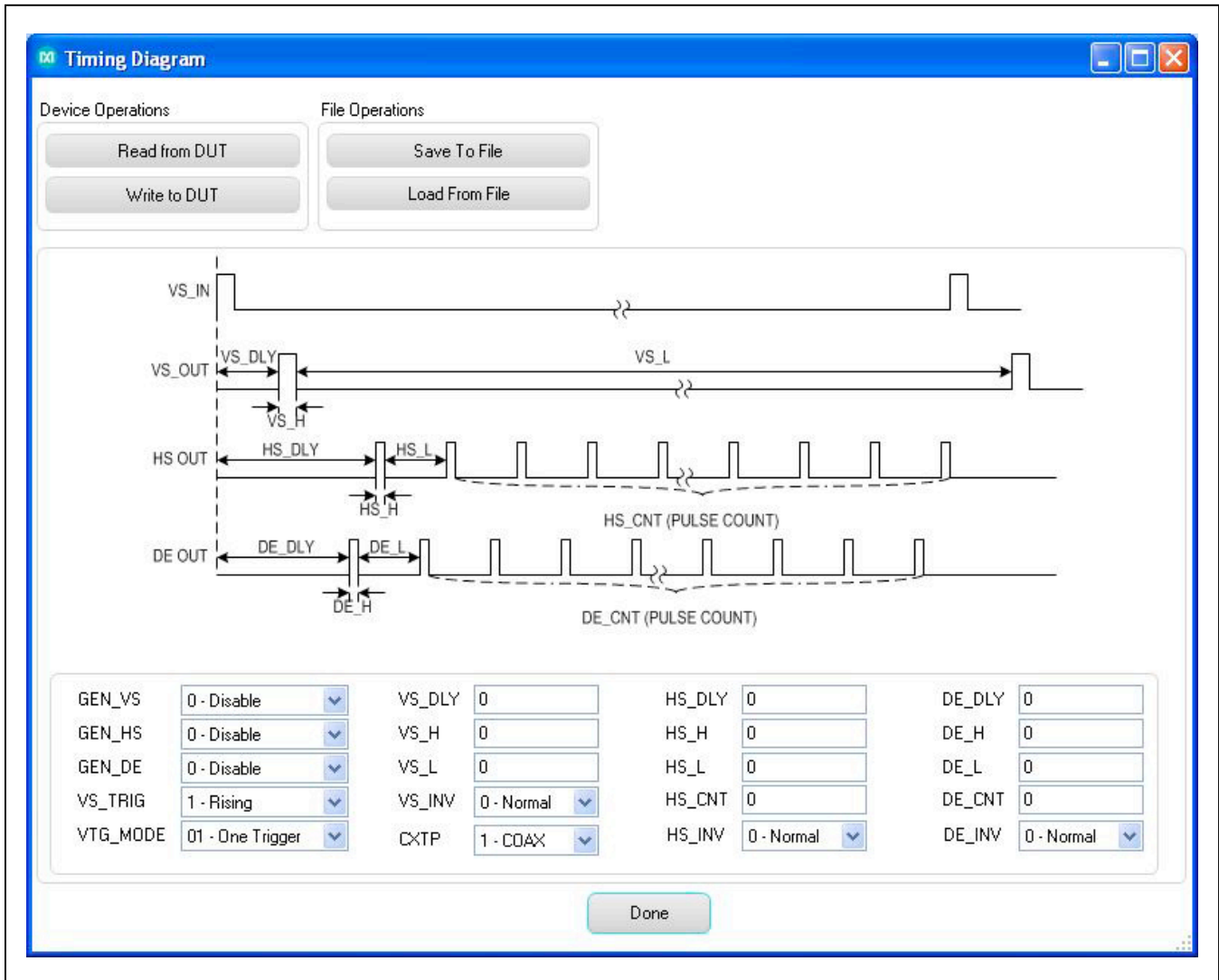

Figure 10. MAXSerDesEV-N EV Kit Software: Evaluation Kit Window (Timing Generator Window)

On the **Additional Features** tab, press the **Equalizer Visualization** button to launch this function (Figure 11), which allows compensating for higher cable attenuation

at higher frequencies. Refer to the respective IC data sheet for detailed description. **Note:** This function is not available in the MAX96708 IC.

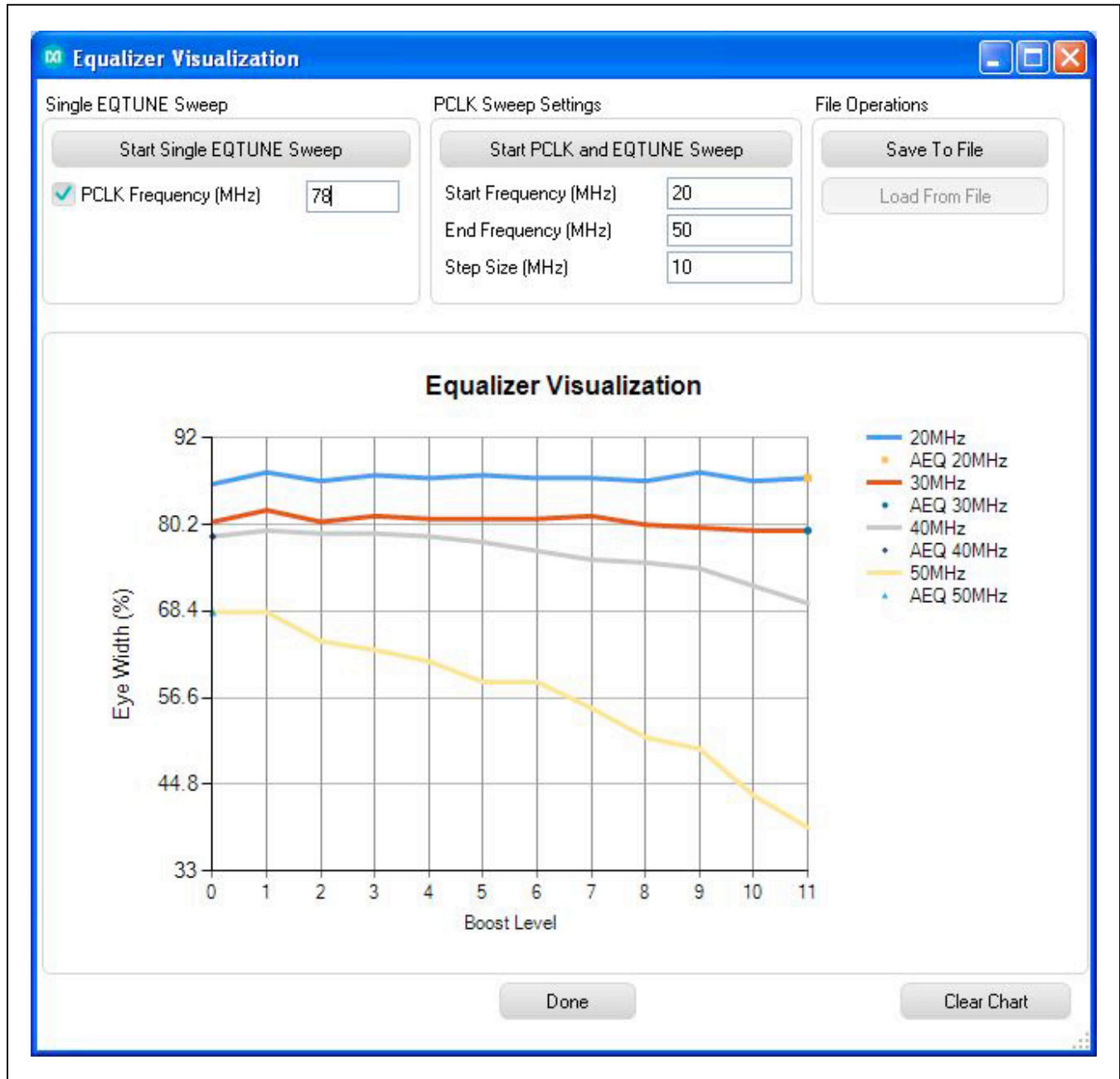

Figure 11. MAXSerDesEV-N EV Kit Software: Evaluation Kit Window (Equalizer Visualization Window)

On the **Additional Features** tab, press the **Eye Width Measurement** button to launch this function (Figure 12), which graphically displays eye width/opening of the high-

speed data over the link. Refer to the respective IC data sheet for a detailed description. **Note:** This function is not available in the MAX96708 IC.

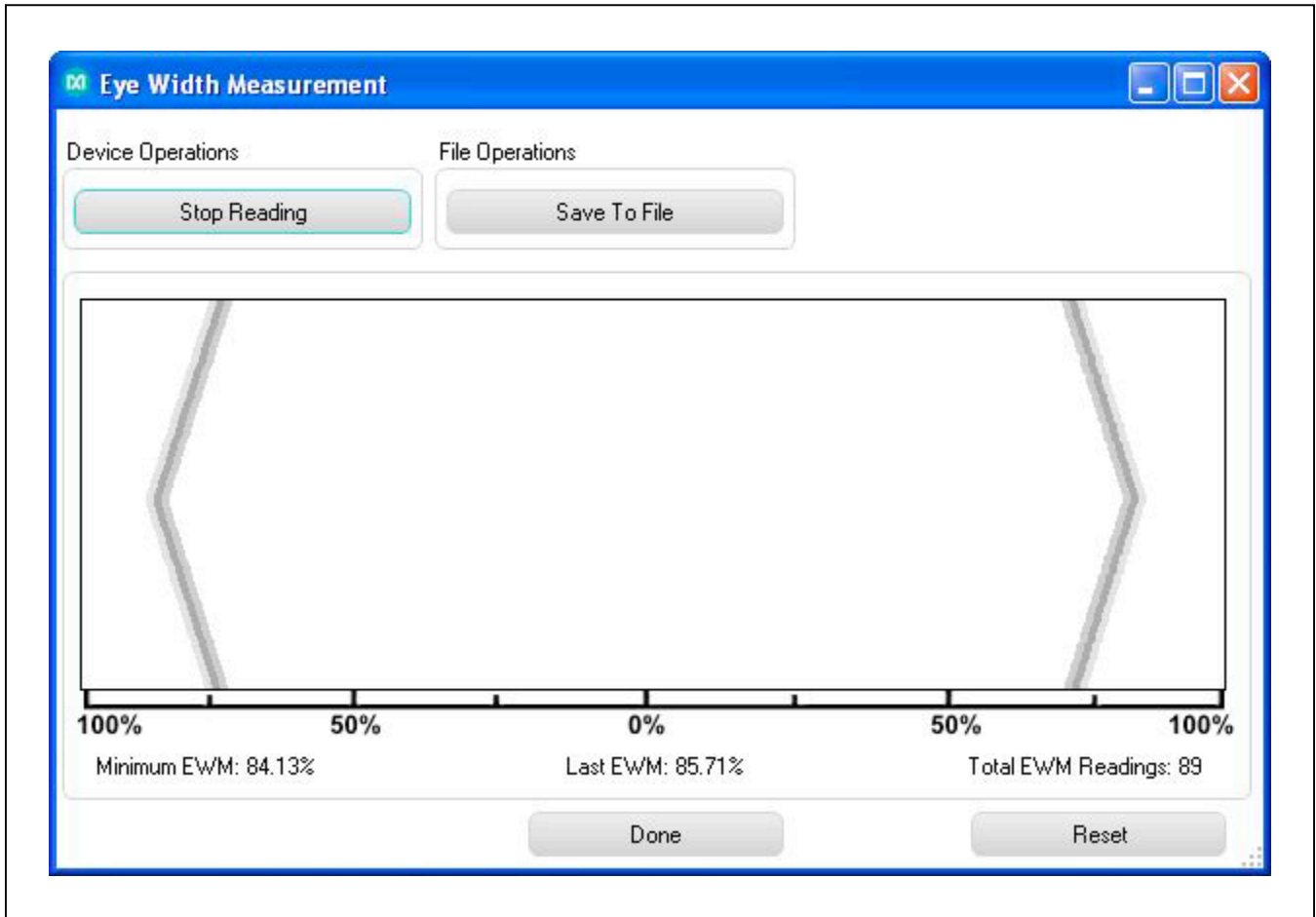

Figure 12. MAXSerDesEV-N EV Kit Software: Evaluation Kit Window (Eye Width Measurement Window)

On the **Additional Features** tab, press the **Show PRBS Test** button to perform a PRBS test (Figure 13). Enter test duration (maximum 32,767s = 9.1hrs) in the **Duration** edit

box and press **Start** to start the test. At test completion, the number of bit errors are read from the PRBSERR register and displayed in the **PRBS Error Counter** box.

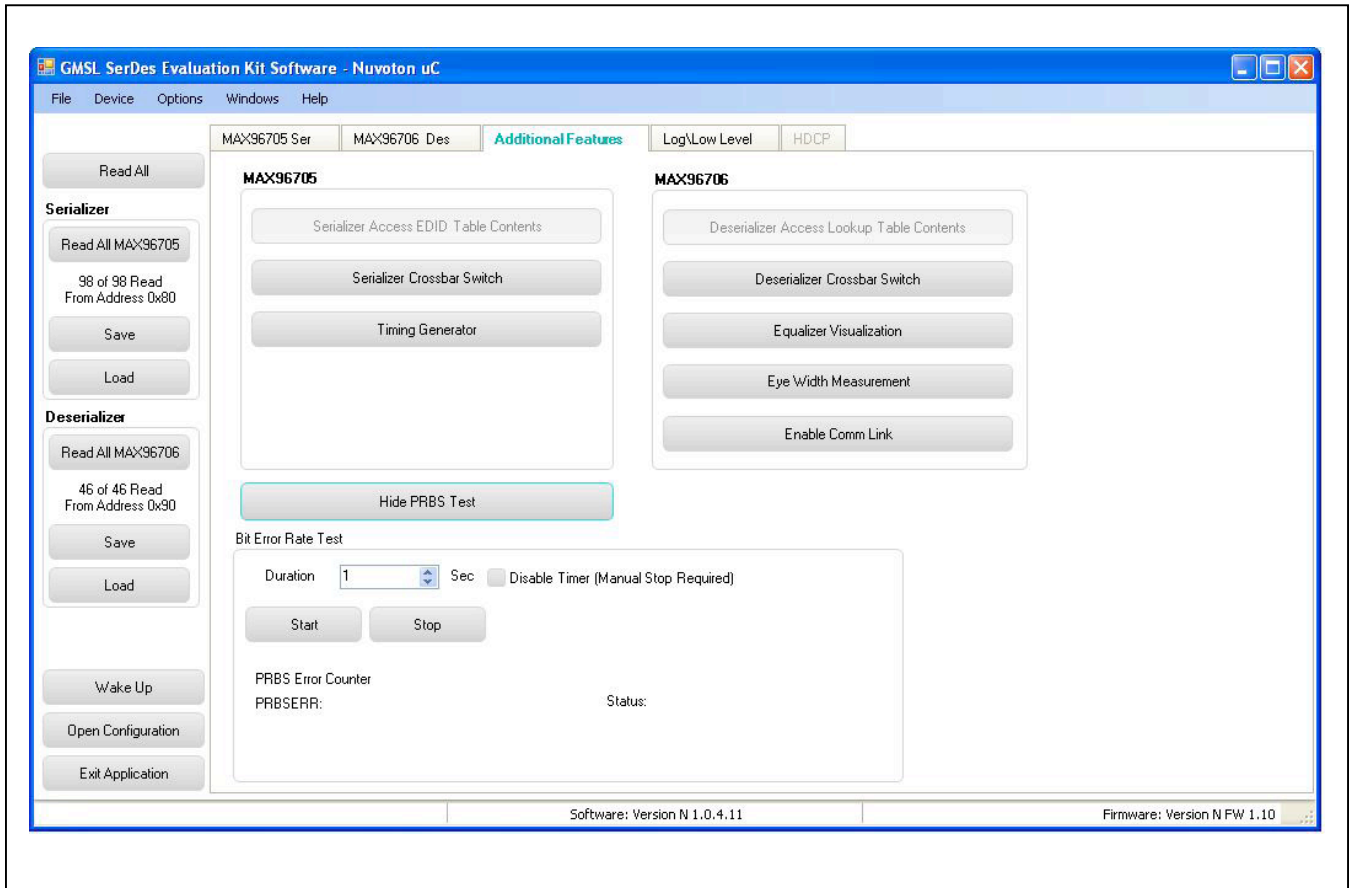

Figure 13. MAXSerDesEV-N EV Kit Software: Evaluation Kit Window (Expanded PRBS Test Window)

Log\Low Level Tab

The **Log\Low Level** tab (Figure 14) logs all activities between the GUIs and DUTs.

The **Register Access** group box allows reads or writes of the specified slave and register addresses. Use the **Send String to EVKIT** button to communicate with non-register-based devices (such as the MAX7324). The **SerDes Baud Rate** drop-down list sets the

communications baud rate. Note that the baud rate should be changed in small increments/decrements (one step change is forced by the GUI).

On the **Log\Low Level** tab, the **16-Bit Register Address Read** block allows programming devices with any combination of 16-bit/8-bit register address/data.

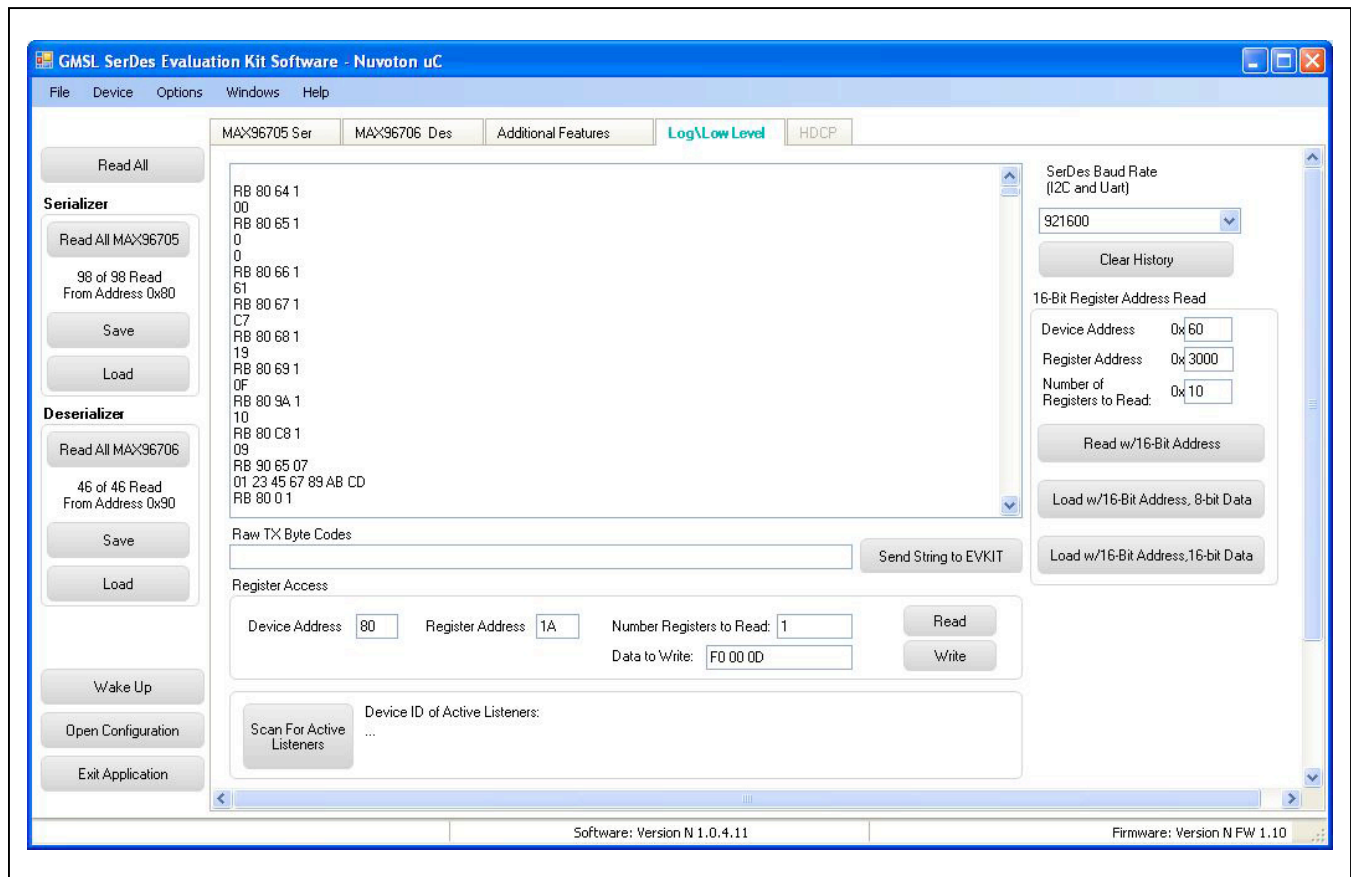

Figure 14. MAXSerDesEV-N EV Kit Software: Evaluation Kit Window (Log\Low Level Tab)

Detailed Description of Firmware

The Nuvoton microcontroller on the daughter board runs a custom firmware that ensures reliable communication between the PC and DUTs. The firmware records 9-bit even-parity data received from the USB interface while RTS is set, and plays back the 9-bit data with 1.5 stop bits timing when RTS is cleared. Data received from the DUTs is immediately relayed to the USB port.

Detailed Description of Hardware

The MAX96706/MAX96708 EV kit provides a proven design and layout for the MAX96706 and MAX96708 GMSL deserializers, designed to be reliable with ease of use and flexibility. The evaluation board has FAKRA connectors to receive the GMSL serial-data input and outputs data in parallel format. On-board level translators and an easy-to-use USB-PC connection are included on the EV kit.

The MAX96706/708 EV kit board consists of three principal functional blocks:

- 1) Microcontroller daughter board
- 2) Application circuit block
- 3) Power-supply block

Microcontroller Daughter Board

The Nuvoton-based microcontroller daughter board provides UART and I²C interfaces that communicate with both serializer and deserializer boards when they are powered on and properly configured. The Nuvoton microcontroller is programmed with the latest firmware available at the time of manufacturing.

To use the EV kit with an externally applied controller, remove the Nuvoton microcontroller daughter board from the EV kit board (DB1 position) and apply RX/SDA, TX/SCL, VDD, and GND signals from the user microcontroller to the corresponding signals on J22 of the deserializer board. Use 3.3V or 5V logic level from VDD_REF, J48 header, or apply externally.

Application Circuit Block

The application circuit block includes the deserializer and all other components and circuits suggested in the respective IC data sheet, test points, and provisions to provide access to internal functions of the deserializer for evaluation of the product.

Power Supplies

On-board LDO regulators U2, U3, and U12 generate various voltage levels required to operate the EV kit board. There are four options to power the board:

- 1) USB port (default)
- 2) 12V AC adapter
- 3) 5V power applied on +5VIN/GND terminals
- 4) Power over coax (POC), sourced by the serializer

Use header JU1 (5V0) to select the source powering the board. To operate the EV kit with voltage levels different from what are generated by on-board regulators, move the desired IOVDD (JU2), DVDD (JU3), and AVDD (JU4) shunts from the INT to EXT position and apply the desired external voltage to the corresponding wire-loop terminal

MAX96706/MAX96708 Evaluation Kit

Evaluates: MAX96706/MAX96708
with Coax or STP Cable

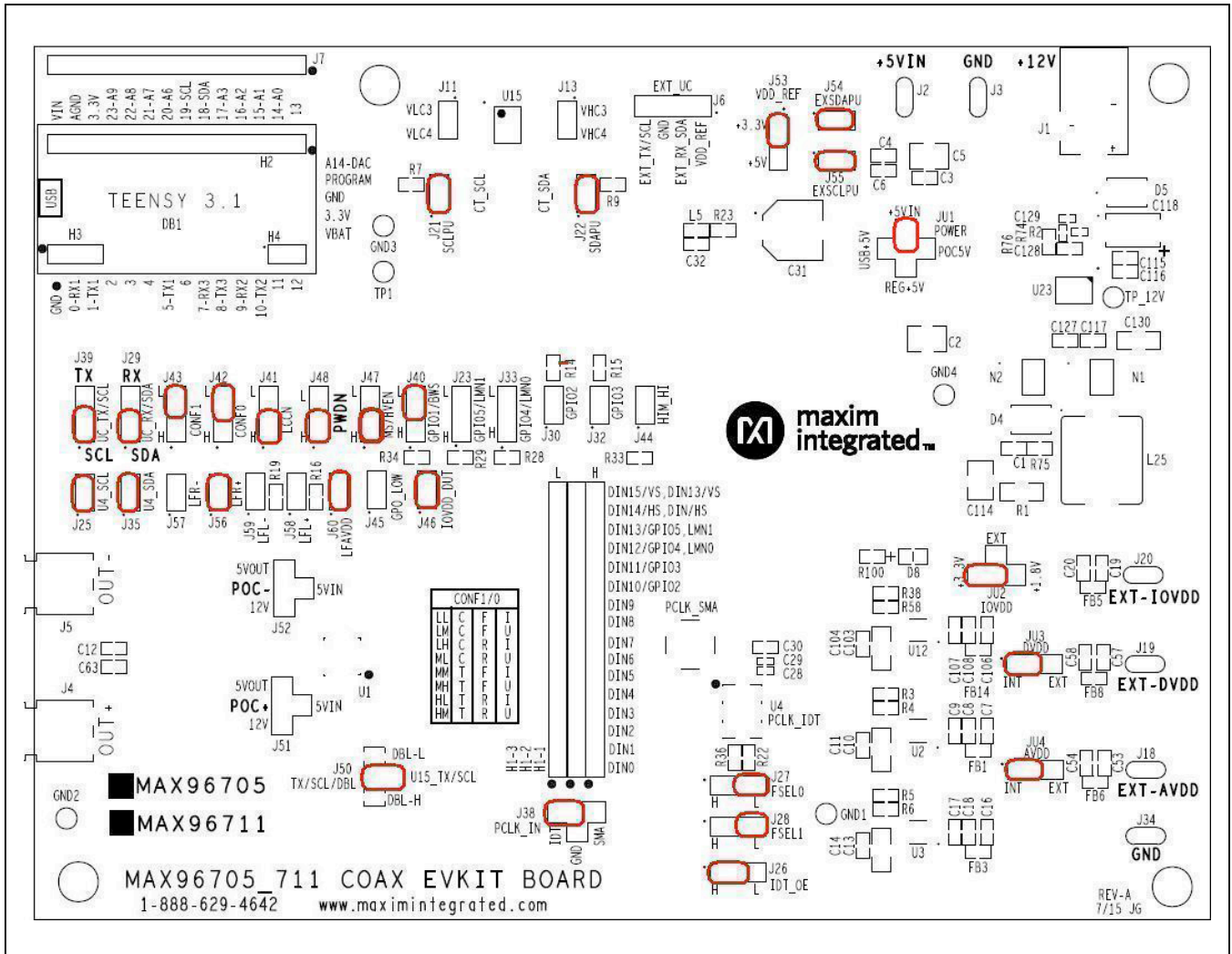

Figure 15. MAX96705/MAX711 Coax EV Kit Jumper Settings for Coax Link and I²C Communication

Component Suppliers

SUPPLIER	PHONE	WEBSITE
Amphenol RF	800-627-7100	www.amphenolrf.com
Hong Kong X'tals Ltd.	852-35112388	www.hongkongcrystal.com
Murata Americas	770-436-1300	www.murataamericas.com
ON Semiconductor	602-244-6600	www.onsemi.com
Rosenberger Hochfrequenztechnik GmbH	011-49-86 84-18-0	www.rosenberger.de
TDK Corp.	847-803-6100	www.component.tdk.com

Note: Indicate that you are using the MAX96706 or MAX96711 when contacting these component suppliers.

Component List, Schematics, and PCB Layout

Click on the links below for component information, schematics, and PCB layout diagrams:

- [MAX96706/MAX96708 EV Kit BOM](#)
- [MAX96706/MAX96708 EV Kit Schematics](#)
- [MAX96706/MAX96708 EV Kit PCB Layout](#)

Errata

On the MAX96706_708 COAX EVKIT BOARD REV-A silkscreen, the labels for headers J32 and J38 are swapped. The correct labels are listed below:

- Header J32 is CXTP_DE
- Header J38 is IOVDD_DUT

Ordering Information

PART	TYPE
MAX96706 COAXEVKIT#	EV Kit
MAX96708 COAXEVKIT#	EV Kit
MAXCOAX2STP-HSD#	Adapter Kit

#Denotes RoHS compliant.

Note: The MAX96706 and MAX96708 coax EV kits are normally ordered with a companion board:

- MAX96705 coax EV kit (MAX96705COAXEVKIT#), or
- MAX96711 coax EV kit (MAX96711COAXEVKIT#).

Revision History

REVISION NUMBER	REVISION DATE	DESCRIPTION	PAGES CHANGED
—	1/16	Initial release	—

For pricing, delivery, and ordering information, please contact Maxim Direct at 1-888-629-4642, or visit Maxim Integrated's website at www.maximintegrated.com.

Maxim Integrated cannot assume responsibility for use of any circuitry other than circuitry entirely embodied in a Maxim Integrated product. No circuit patent licenses are implied. Maxim Integrated reserves the right to change the circuitry and specifications without notice at any time.

TITLE: Bill of Materials

DATE: 1/11/16

DESIGN: max96706_08_evkit_a

NOTE: DNI = DO NOT INSTALL; DNP = DO NOT PROCURE

REF_DES	DNI/DNP	QTY	VALUE	DESCRIPTION	MFG PART #	MANUFACTURER
C1	-	1	1500PF	CAPACITOR; SMT (0603); CERAMIC CHIP; 1500PF; 50V; TOL=10%; MODEL=C SERIES; HIGH TEMPERATURE; TG=-55 DEGC TO +150 DEGC; TC=X8R	C1608X8R1H152K080	TDK
C2	-	1	10UF	CAPACITOR; SMT (1210); CERAMIC CHIP; 10UF; 16V; TOL=20%; MODEL=; TG=-55 DEGC TO +125 DEGC; TC=X7R	C1210C106M4RAC; C3225X7R1C106M200AB	KEMET/TDK
C3, C8, C18, C108, C115, C127	-	6	10UF	CAPACITOR; SMT (0603); CERAMIC CHIP; 10UF; 16V; TOL=20%; TG=-25 DEGC TO +85 DEGC; TC=JB	C1608JB1C106M080AB	TDK
C4, C6, C7, C9, C16, C17, C106, C107, C116, C117	-	10	0.1UF	CAPACITOR; SMT (0603); CERAMIC CHIP; 0.1UF; 25V; TOL=10%; MODEL=C SERIES; TG=-55 DEGC TO +125 DEGC; TC=X7R	C1608X7R1E104K080AA	TDK
C5, C34, C41, C45, C64, C114	-	6	100UF	CAPACITOR; SMT (1210); CERAMIC CHIP; 100UF; 10V; TOL=20%; MODEL=CL SERIES; TG=-55 DEGC TO +85 DEGC; TC=X5R	CL32A107MPVNNN	SAMSUNG ELECTRONICS
C10, C13, C103, C130	-	4	10UF	CAPACITOR; SMT (1206); CERAMIC CHIP; 10UF; 10V; TOL=20%; MODEL=C SERIES; TG=-55 DEGC TO +85 DEGC; TC=X5R	C3216X5R1A106M160	TDK
C11, C14, C19, C20, C53, C54, C57, C58, C104	-	9	4.7UF	CAPACITOR; SMT (0603); CERAMIC; 4.7UF; 6.3V; TOL=20%; MODEL=C SERIES; TG=-55 DEGC TO +85 DEGC; TC=X5R	C1608X5R0J475M080AB; GRM188R60J475ME19; JMK107BJ475MA-T	TDK/MURATA/TAIYO YUDEN
C15, C22, C27, C35, C42, C46, C61	-	7	0.1UF	CAPACITOR; SMT (0402); CERAMIC CHIP; 0.1UF; 16V; TOL=10%; TG=-55 DEGC TO +125 DEGC; TC=X7R;	C0402X7R160-104KNE; CL05B104KO5NNNC; GRM155R71C104KA88; C1005X7R1C104K; CC0402KRX7R7BB104; EMK105B7104KV	VENKEL LTD./SAMSUNG ELECTRONICS/MURATA/TDK/YAGEO PHICOMP/TAIYO YUDEN
C23, C25, C26, C36, C43, C47, C60, C97	-	8	1000PF	CAPACITOR; SMT (0402); CERAMIC CHIP; 1000PF; 50V; TOL=10%; MODEL=C SERIES; TG=-55 DEGC TO +125 DEGC; TC=X7R	C1005X7R1H102K050BA	TDK
C33, C40, C44, C62, C63, C70-C72	-	8	0.22UF	CAPACITOR; SMT (0603); CERAMIC CHIP; 0.22UF; 50V; TOL=10%; MODEL=C SERIES; TG=-55 DEGC TO +125 DEGC; TC=X7R	C1608X7R1H224K080	TDK

REF_DES	DNI/DNP	QTY	VALUE	DESCRIPTION	MFG PART #	MANUFACTURER
C85, C96, C99, C100	-	4	0.1UF	CAPACITOR; SMT (0402); CERAMIC; 0.1UF; 16V; TOL=10%; MODEL=GRM SERIES; TG=-55 DEGC to +85 DEGC; TC=X5R	GRM155R61C104KA88	MURATA
C118	-	1	100UF	CAPACITOR; SMT (7343); TANTALUM CHIP; 100UF; 16V; TOL=20%; MODEL=TQC SERIES	16TQC100MYF	PANASONIC
C129	-	1	2200PF	CAPACITOR; SMT (0402); CERAMIC CHIP; 2200PF; 50V; TOL=10%; MODEL=C SERIES; TG=-55 DEGC TO +125 DEGC; TC=X7R	C1005X7R1H222K050BA	TDK
D4, D5	-	2	B360B-13-F	DIODE; SCH; SCHOTTKY BARRIER DIODE; SMB; PIV=60V; Io=3A; -55 DEGC TO +125 DEGC	B360B-13-F	DIODES INCORPORATED
D8, ERR_LED, LFLT_LED	-	3	SML-210VTT86	DIODE; LED; SML-21 SERIES; RED; SMT (0805); PIV=2V; IF=0.02A	SML-210VTT86	ROHM
L4, FB1, FB3, FB5, FB6, FB8, FB14	-	7	120	INDUCTOR; SMT (0603); FERRITE-BEAD; 120; TOL=+/-25%; 3A	BLM18SG121TN1	MURATA
GND1	-	1	N/A	TEST POINT; PIN DIA=0.1IN; TOTAL LENGTH=0.3IN; BOARD HOLE=0.04IN; BLACK; PHOSPHOR BRONZE WIRE SILVER PLATE FINISH;	5001	KEYSTONE
H1_1, H1_2	-	2	PBC15SAAN	CONNECTOR; MALE; THROUGH HOLE; BREAKAWAY; STRAIGHT; 15PINS; -65 DEGC TO +125 DEGC	PBC15SAAN	SULLINS ELECTRONICS CORP.
H2	-	1	PPPC141LFBN-RC	CONNECTOR; FEMALE; THROUGH HOLE; LFB SERIES; 2.54MM CONTACT CENTER; STRAIGHT; 14PINS	PPPC141LFBN-RC	SULLINS ELECTRONICS CORP
H3	-	1	PPPC031LFBN-RC	CONNECTOR; FEMALE; THROUGH HOLE; LFB SERIES; 2.54MM CONTACT CENTER; STRAIGHT; 3PINS	PPPC031LFBN-RC	SULLINS ELECTRONICS CORP
H4	-	1	PPPC021LFBN-RC	CONNECTOR; FEMALE; THROUGH HOLE; LFB SERIES; 2.54MM CONTACT CENTER; STRAIGHT; 2PINS	PPPC021LFBN-RC	SULLINS ELECTRONICS CORP
J1	-	1	PJ-002AH	CONNECTOR; MALE; THROUGH HOLE; DC POWER JACK; RIGHT ANGLE; 3PINS	PJ-002AH	CUI INC.
J2, J3, J18-J20, J34	-	6	MAXIMPAD	EVK KIT PARTS; MAXIM PAD; WIRE; NATURAL; SOLID; WEICO WIRE; SOFT DRAWN BUS TYPE-S; 20AWG	9020 BUSS	WEICO WIRE
J4, J5, J41, J43	-	4	59S2AX-400A5-Z	CONNECTOR; MALE; THROUGH HOLE; RIGHT ANGLE PLUG FOR PCB; RIGHT ANGLE; 5PINS	59S2AX-400A5-Z	ROSENBERGER
J6-J9, JU2	-	5	PEC04SAAN	CONNECTOR; MALE; THROUGH HOLE; BREAKAWAY; STRAIGHT; 4PINS	PEC04SAAN	SULLINS ELECTRONICS CORP.
J10-J17, J21	-	9	PEC02SAAN	CONNECTOR; MALE; THROUGH HOLE; BREAKAWAY; STRAIGHT; 2PINS	PEC02SAAN	SULLINS

REF_DES	DNI/DNP	QTY	VALUE	DESCRIPTION	MFG PART #	MANUFACTURER
J22	-	1	PEC04SAAN	CONNECTOR; MALE; THROUGH HOLE; BREAKAWAY; STRAIGHT; 4PINS	PEC04SAAN	SULLINS ELECTRONICS CORP.
J23, J24, J33, J35, J37, J39, J40, J48	-	8	PCC03SAAN	CONNECTOR; MALE; THROUGH HOLE; BREAKAWAY; STRAIGHT THROUGH; 3PINS; -65 DEGC TO +125 DEGC	PCC03SAAN	SULLINS
J25-J28, J30-J32, J38, J42, J44-J47, J49, J53, J54	-	16	PCC02SAAN	CONNECTOR; MALE; THROUGH HOLE; BREAKAWAY; STRAIGHT THROUGH; 2PINS; -65 DEGC TO +125 DEGC	PCC02SAAN	SULLINS
J36	-	1	PBC14SAAN	CONNECTOR; MALE; THROUGH HOLE; BREAKAWAY; STRAIGHT; 14PINS; -65 DEGC TO +125 DEGC	PBC14SAAN	SULLINS ELECTRONICS CORP.
JU1	-	1	PBC05SAAN	CONNECTOR; MALE; THROUGH HOLE; BREAKAWAY; STRAIGHT; 5PINS; -65 DEGC TO +125 DEGC	PBC05SAAN	SULLINS ELECTRONICS CORP.
JU3, JU4	-	2	PEC03SAAN	CONNECTOR; MALE; THROUGH HOLE; BREAKAWAY; STRAIGHT; 3PINS	PEC03SAAN	SULLINS
L1, L8, L12, L15	-	4	330NH	INDUCTOR; SMT (0603); FERRITE CORE; 330NH; TOL=+/-5%; 0.63A	LQW18CNR33J00	MURATA
L2, L7, L11, L14	-	4	6.8UH	INDUCTOR; SMT (1210); WIREWOUND CHIP; 6.8UH; TOL=20%; 0.62A	LBC3225T6R8MR	TAIYO YUDEN
L3, L6, L10, L13	-	4	100UH	INDUCTOR; SMT (2424); WIREWOUND CHIP; 100UH; TOL=20%; 0.92A	LQH6PPN101M43L	MURATA
L25	-	1	1.5UH	INDUCTOR; SMT; FERRITE-BEAD; 1.5UH; TOL=+/-20%; 27A	7443330150	WURTH ELECTRONICS INC.
LOCK_LED	-	1	SML-210MTT86	DIODE; LED; SML-21 SERIES; GREEN; SMT (0805); PIV=2.2V; IF=0.02A	SML-210MTT86	ROHM
MISC2	-	1	MAXEVCNTR-NUV#	EVKIT PART-NUVOTON MICRO CONTROLLER	MAXEVCNTR-NUV#	MAXIM
N1, N2	-	2	FDS8449	TRAN; N-CHANNEL POWER TRENCH MOSFET; NCH; NSOIC8 ; PD-(2.5W); I-(7.6A); V-(40V)	FDS8449	FAIRCHILD SEMICONDUCTOR
R1	-	1	0.015	RESISTOR; 1206; 0.015 OHM; 5%; 200PPM; 1W; THICK FILM	ERJ-8BWJR015V	PANASONIC
R2	-	1	14.3K	RESISTOR, 0402, 14.3K OHM, 1%, 100PPM, 0.0625W, THICK FILM	CRCW040214K3FK	VISHAY DALE
R3, R5, R38	-	3	24.9K	RESISTOR; 0603; 24.9K OHM; 1%; 100PPM; 0.10W; THICK FILM	CRCW060324K9FK	VISHAY DALE
R4	-	1	41.2K	RESISTOR; 0603; 41.2K OHM; 1%; 100PPM; 0.10W; METAL FILM	CRCW060341K2FK	VISHAY DALE
R6, R58	-	2	11K	RESISTOR; 0603; 11K OHM; 1%; 100PPM; 0.10W; THICK FILM	CR0603-FX-1102ELF	BOURNS
R7, R9, R11, R13, R27, R48	-	6	2.2K	RESISTOR, 0603, 2.2K OHM, 1%, 100PPM, 0.10W, THICK FILM	CRCW06032K20FK	VISHAY DALE

REF_DES	DNI/DNP	QTY	VALUE	DESCRIPTION	MFG PART #	MANUFACTURER
R12, R33, R37, R39, R43, R44, R49, R50	-	8	0	RESISTOR; 0402; 0 OHM; 0%; JUMPER; 0.063W; THICK FILM	CRCW04020000ZS	VISHAY DALE
R14, R15, R22, R23, R28, R29, R34	-	7	30K	RESISTOR; 0603; 30K OHM; 1%; 100PPM; 0.10W; THICK FILM	CRCW060330K0FK	VISHAY DALE
R16, R19, R51, R52	-	4	45.3K	RESISTOR; 0603; 45.3KOHM; 1%; 100PPM; 0.10W; THICK FILM	CRCW060345K3FK; ERJ-3EKF4532V	VISHAY DALE/PANASONIC
R17, R20, R53, R54	-	4	4.99K	RESISTOR; 0201; 4.99K OHM; 1%; 100PPM; 0.05W ; THICK FILM	CRCW02014K99FK	VISHAY DALE
R18, R21, R55, R71	-	4	49.9K	RESISTOR; 0201; 49.9K OHM; 1%; 100PPM; 0.05W ; THICK FILM	CRCW020149K9FK	VISHAY DALE
R24, R25, R30, R31, R40, R41, R45, R46	-	8	2K	RESISTOR, 0603, 2K OHM, 1%, 100PPM, 0.10W, THICK FILM	CRCW06032K0FK; ERJ-3EKF2001V	VISHAY DALE/PANASONIC
R26, R32, R42, R47	-	4	2K	RESISTOR; 0201; 2K OHM; 1%; 200PPM; 0.05W; THICK FILM	ERJ-1GEF2001C	PANASONIC
R35, R59, R60	-	3	1K	RESISTOR; 0603; 1K; 1%; 100PPM; 0.10W; THICK FILM	CRCW06031001FK; ERJ-3EKF1001V	VISHAY DALE; PANASONIC
R36	-	1	200K	RESISTOR; 0603; 200K; 1%; 100PPM; 0.10W; THICK FILM	CRCW06032003FK	VISHAY DALE
R57, R77, R78, R100	-	4	1K	RESISTOR; 0603; 1K OHM; 1%; 100PPM; 0.10W; THICK FILM	CR0603-FX-1001ELF	BOURNS
R74	-	1	30K	RESISTOR; 0402; 30K OHM; 1%; 100PPM; 0.063W; THICK FILM	RC0402FR-0730KL	YAGEO PHICOMP
R75, R76	-	2	0	RESISTOR; 0603; 0 OHM; 5%; JUMPER; 0.10W; THICK FILM	RC1608J000CS; CR0603-J-000ELF;RC0603JR-070RL	SAMSUNG ELECTRONICS/BOURNS/YAGEO PH
TP1, TP_ERRB, TP_LOCK, TP_LFLT B	-	4	N/A	TEST POINT; PIN DIA=0.1IN; TOTAL LENGTH=0.3IN; BOARD HOLE=0.04IN; RED; PHOSPHOR BRONZE WIRE SILVER PLATE FINISH;	5000	KEYSTONE
U1	-	1	MAX96706GTJ	IC; HS80 PRELIMINARY; PACKAGE OUTLINE 32 TQFN; 0.50MM PITCH; 21-0140/T3255-8; MAX96706	MAX96706GTJ	MAXIM
U2,U3,U12	-	3	MAX1792EUA33	IC; VREG; LOW-DROPOUT LINEAR REGULATOR; UMAX8	MAX1792EUA33	MAXIM
U4-U6	-	3	74LVC1G86GV	IC; XOR; 2-INPUT EXCLUSIVE-OR GATE; SOT753	74LVC1G86GV	NXP
U15	-	1	MAX3378EEUD+	IC; TRANS; +/-15KV ESD-PROTECTED, 1UA, 16MBPS, QUAD LOW-VOLTAGE LEVEL TRANSLATOR; TSSOP14	MAX3378EEUD+	MAXIM
U23	-	1	MAX16952AUE/V+	IC; CTRL; STEP-DOWN CONTROLLER WITH LOW OPERATING CURRENT; TSSOP16-EP	MAX16952AUE/V+	MAXIM

REF_DES	DNI/DNP	QTY	VALUE	DESCRIPTION	MFG PART #	MANUFACTURER
X1-X4	-	4	EVKIT_STANDOFF_4-4	KIT; ASSY-STANDOFF 3/8IN; 1PC. STANDOFF/FEM/HEX/4-40IN/(3/8IN)/NYLON; 1PC. SCREW/SLOT/PAN/4-40IN/(3/8IN)/NYLON	EVKIT_STANDOFF_4-40_3/8	?
MISC1	DNI	1	AK67421-1-R	CONNECTOR; MALE; USB; USB2.0 MICRO CONNECTION CABLE; USB B MICRO MALE TO USB A MALE; STRAIGHT; 5PINS-4PINS	AK67421-1-R	ASSMANN
SU1-SU25	DNI	25	STC02SYAN	TEST POINT; JUMPER; STR; TOTAL LENGTH=0.256IN; BLACK; INSULATION=PBT CONTACT=PHOSPHOR BRONZE; COPPER PLATED TIN OVERALL	STC02SYAN	SULLINS ELECTRONICS CORP.
C37, C48, C49, C59, C128	DNP	5	OPEN	PACKAGE OUTLINE 0603 NON-POLAR CAPACITOR	N/A	N/A
DB1	DNP	1	TEENSY 3.1	EVKIT PART; MODULE; CTRL; TEENSY USB DEVELOPMENT BOARD; TH-37; CUSTOM PART ONLY	TEENSY 3.1	PJRC
		268				

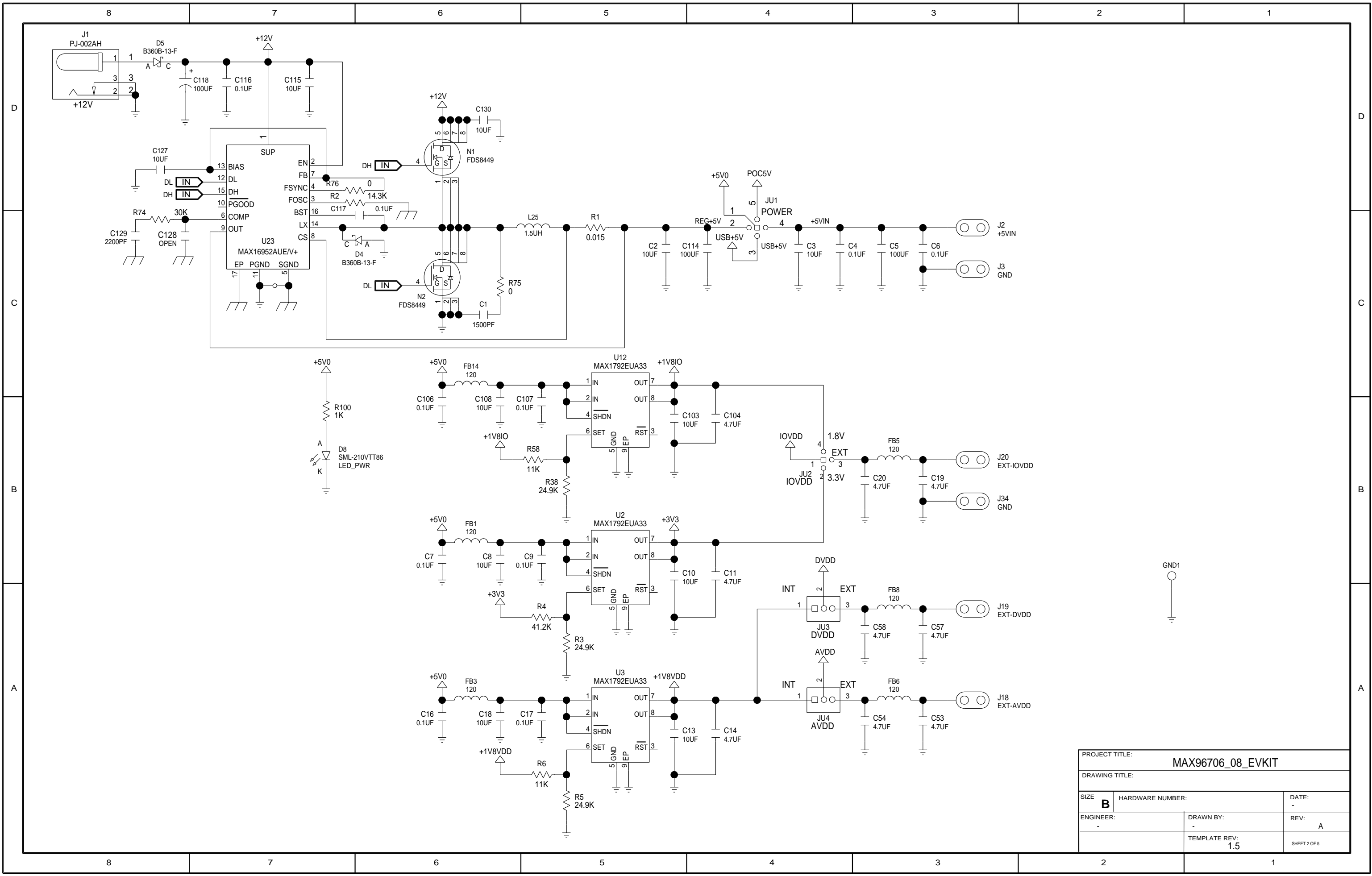

PROJECT TITLE:		
MAX96706_08_EVKIT		
DRAWING TITLE:		
SIZE B	HARDWARE NUMBER:	DATE:
ENGINEER:	DRAWN BY:	REV: A
	TEMPLATE REV: 1.5	SHEET 2 OF 5

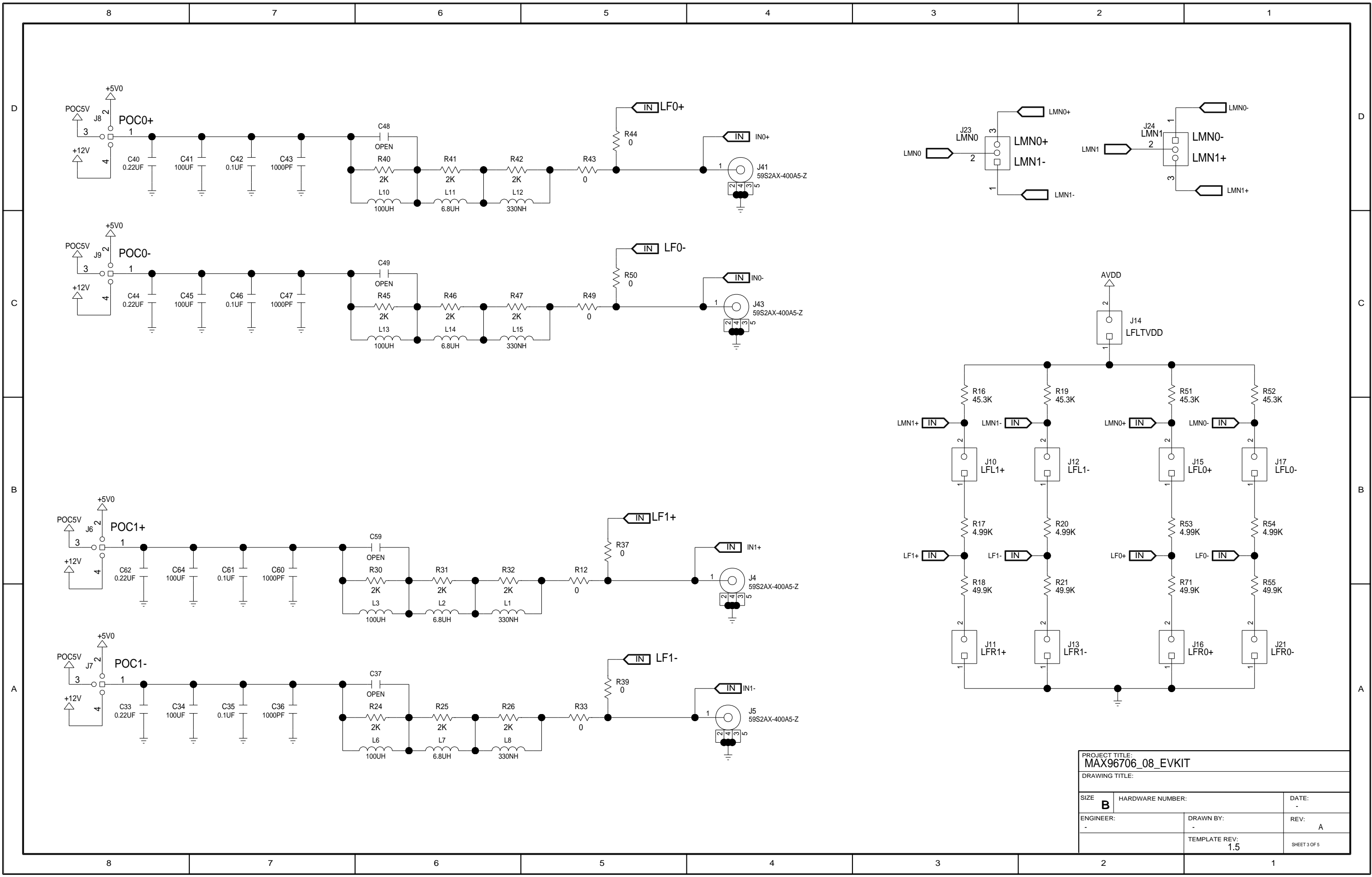

PROJECT TITLE: MAX96706_08_EVKIT		
DRAWING TITLE:		
SIZE B	HARDWARE NUMBER:	DATE: -
ENGINEER: -	DRAWN BY: -	REV: A
	TEMPLATE REV: 1.5	SHEET 3 OF 5

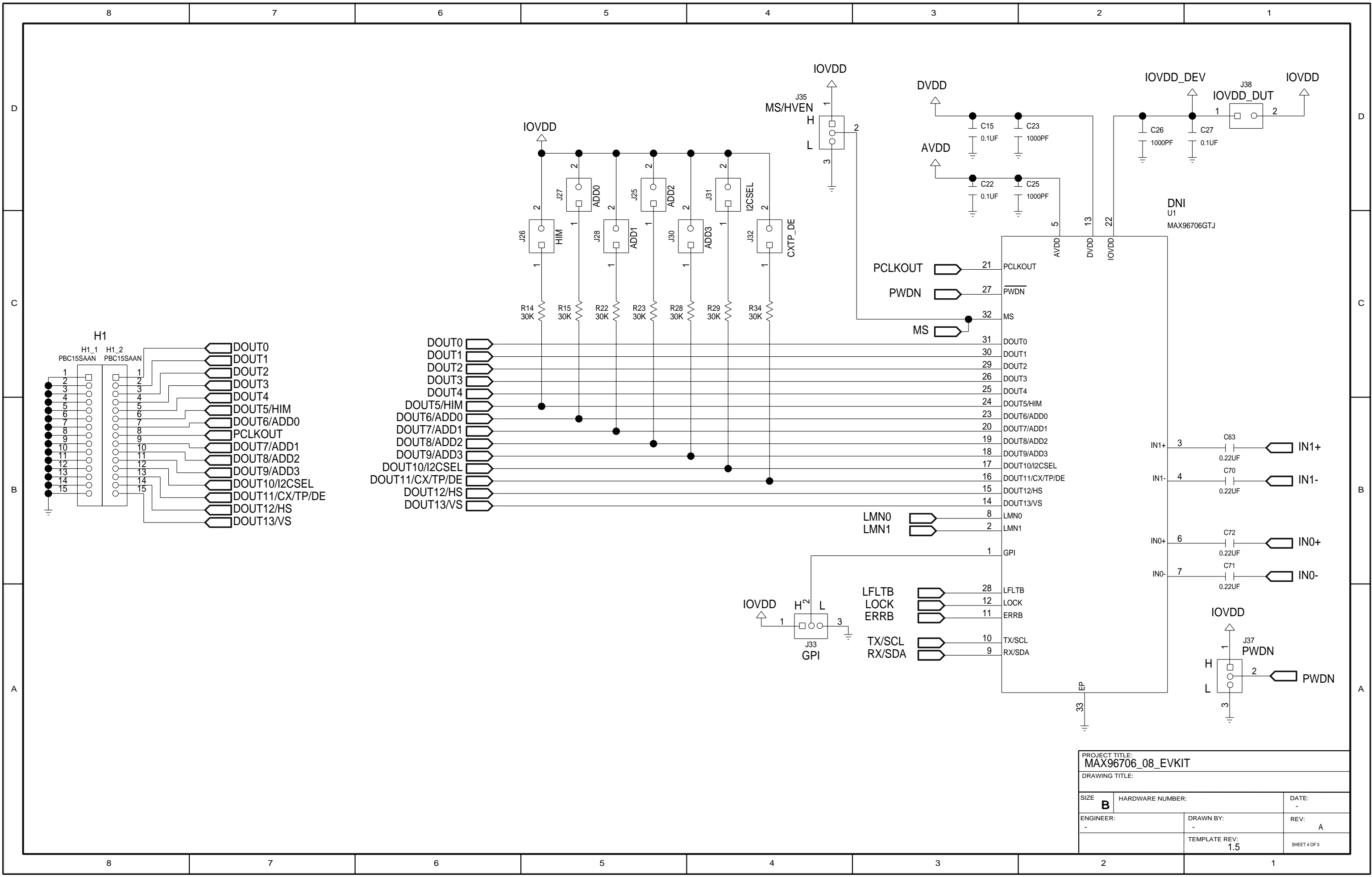

PROJECT TITLE: MAX96706_08_EVKIT		
DRAWING TITLE:		
SIZE B	HARDWARE NUMBER:	DATE: -
ENGINEER: -	DRAWN BY: -	REV: A
	TEMPLATE REV: 1.5	SHEET 4 OF 5

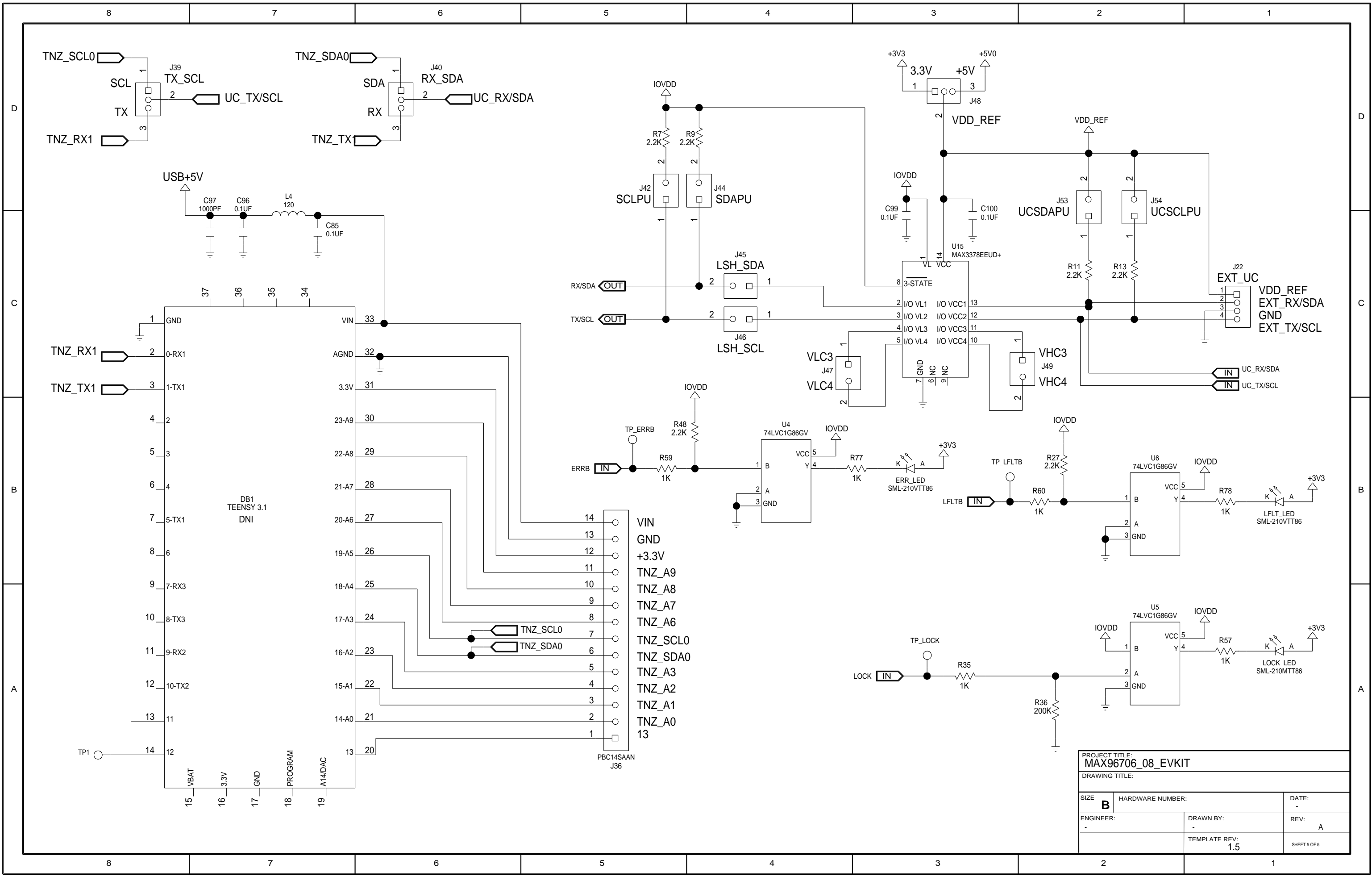

PROJECT TITLE: MAX96706_08_EVKIT		
DRAWING TITLE:		
SIZE B	HARDWARE NUMBER:	DATE: -
ENGINEER: -	DRAWN BY: -	REV: A
	TEMPLATE REV: 1.5	SHEET 5 OF 5



This document contains information considered proprietary, and shall not be reproduced, stored in a retrieval system, or disclosed to others without specific written permission.

HARDWARE NAME: MAX96706_08_EVKIT_A

HARDWARE NUMBER:

ENGINEER: DESIGNER:

DATE: 08/07/2015 ODB++/GERBER: SILK_TOP

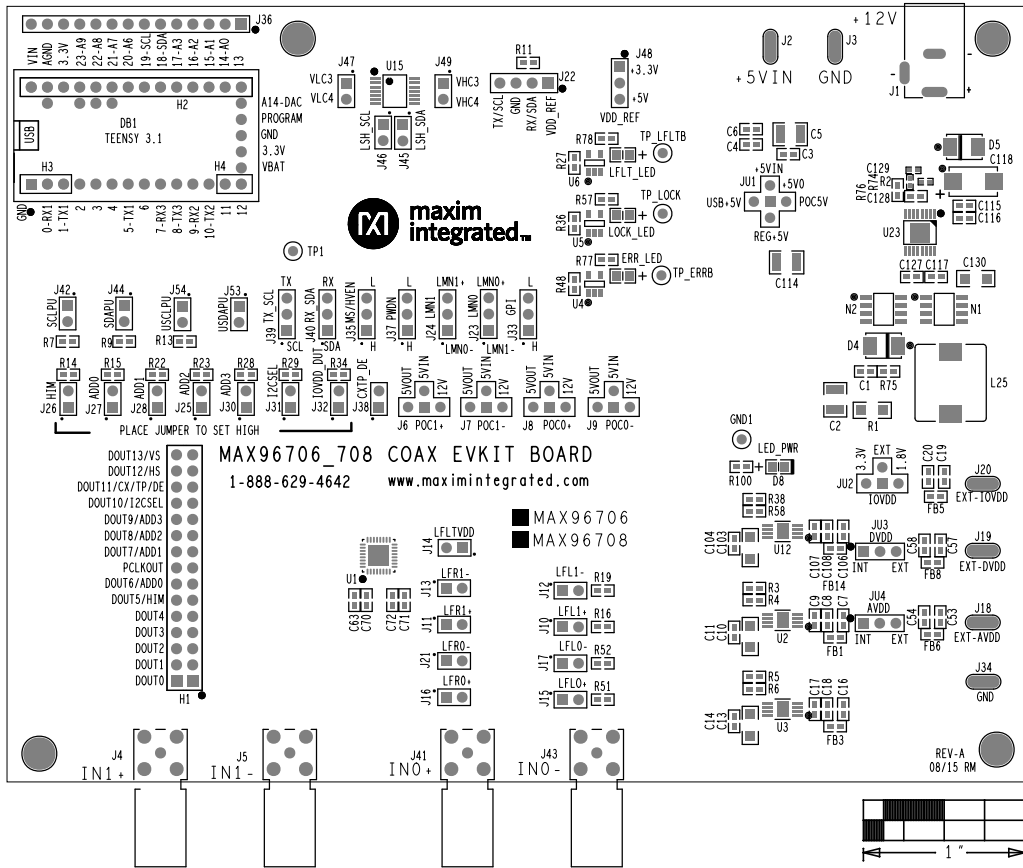



This document contains information considered proprietary, and shall not be reproduced, stored in a retrieval system, or disclosed to others without specific written permission.

HARDWARE NAME: MAX96706_08_EVKIT_A

HARDWARE NUMBER:

ENGINEER:

DESIGNER:

DATE: 08/07/2015

ODB++/GERBER: TOP

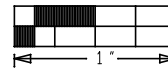
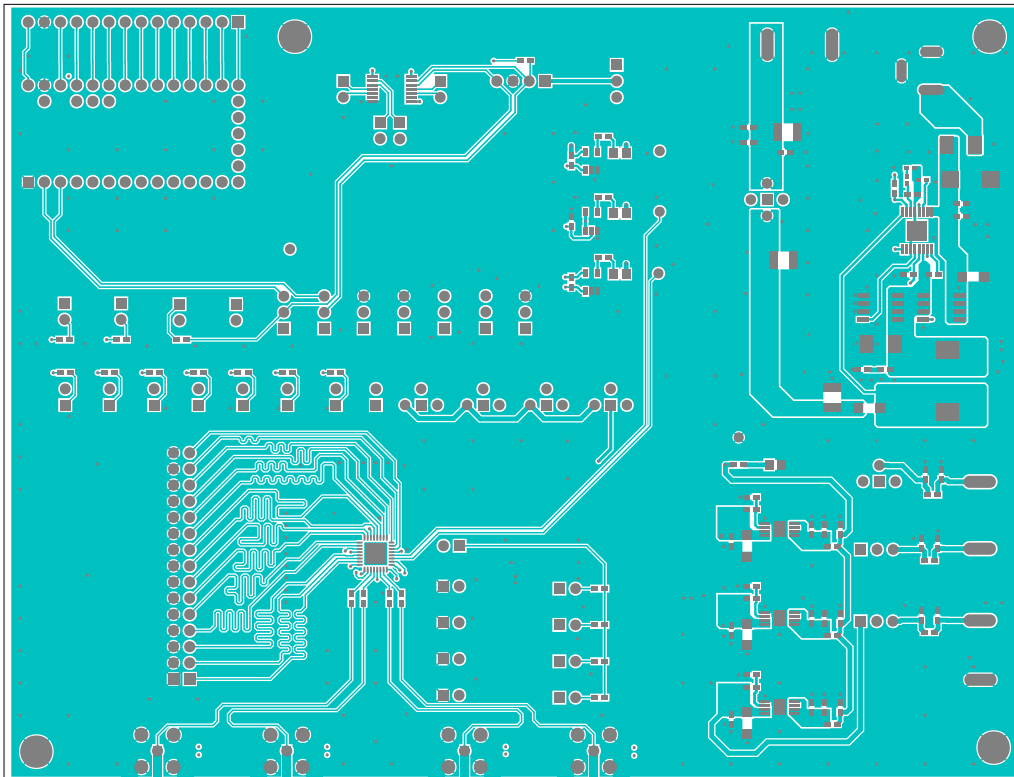



This document contains information considered proprietary, and shall not be reproduced wholly or in part, nor disclosed to others without specific written permission.

HARDWARE NAME: MAX96706_08_EVKIT_A

HARDWARE NUMBER:

ENGINEER:

DESIGNER:

DATE: 08/07/2015

ODB++/GERBER: INNER_LAYER2

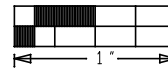
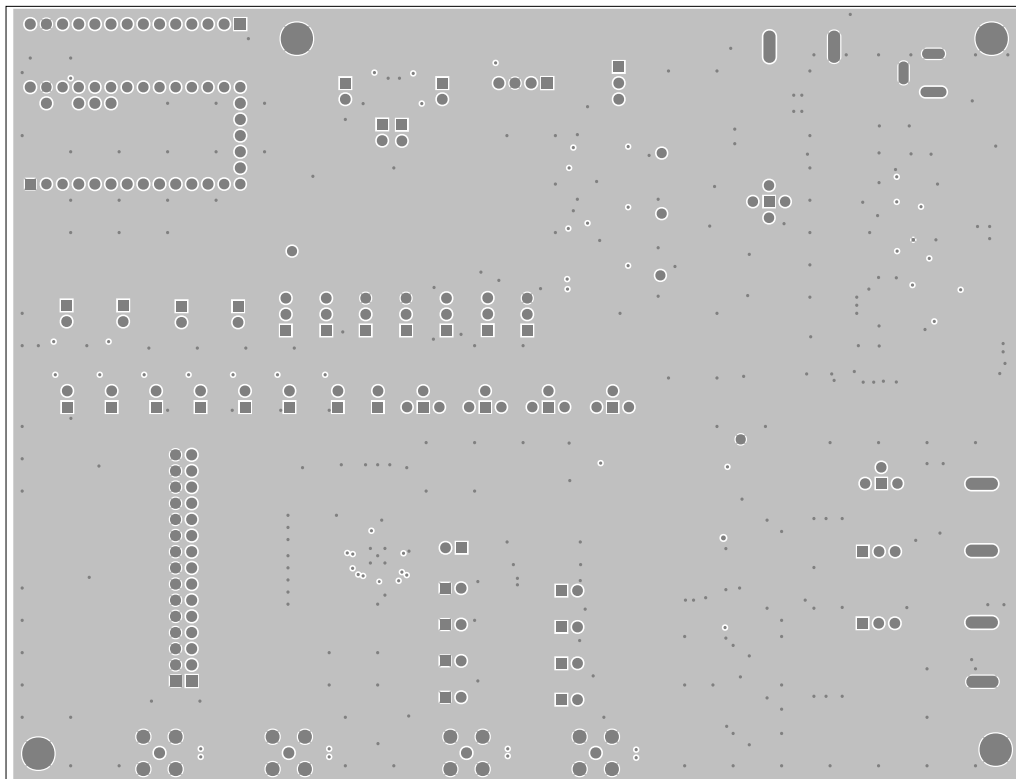



This document contains information considered proprietary, and shall not be reproduced, stored in a retrieval system, or disclosed to others without specific written permission.

HARDWARE NAME: MAX96706_08_EVKIT_A

HARDWARE NUMBER:

ENGINEER:

DESIGNER:

DATE: 08/07/2015

ODB++/GERBER: INNER_LAYER3

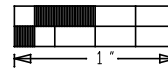
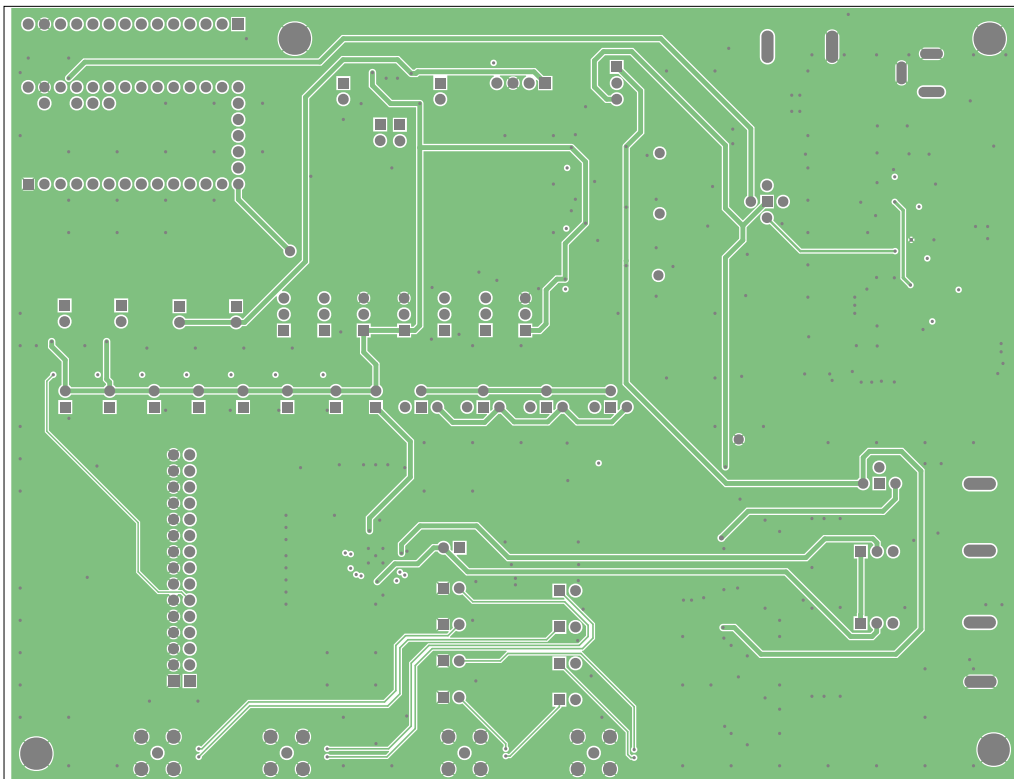



This document contains information considered proprietary, and shall not be reproduced, stored in a retrieval system, or disclosed to others without specific written permission.

HARDWARE NAME: MAX96706_08_EVKIT_A

HARDWARE NUMBER:

ENGINEER:

DESIGNER:

DATE: 08/07/2015

ODB++/GERBER: BOTTOM

