

## MAX98390 Evaluation System

Evaluates: MAX98390 (C/D)

### General Description

The MAX98390C/D evaluation system (EV system) evaluates the MAX98390C or the MAX98390D boosted Class D audio amplifier with integrated Dynamic Speaker Management™ (DSM) IC. DSM senses the voltage and current at the load and uses patented Maxim algorithms to unlock the full potential of the speaker. The EV system comprises the MAX98390C or the MAX98390D Development Board (DEV board), Maxim's Audio Interface Board III (AUDINT3), 5V power supply, reference micro-speaker, USB cable, DSM Sound Studio software, and MAX98390 evaluation software.

It is recommended that the DEV board be evaluated with the AUDINT3 board as an EV system. MAX98390C/D supports standard I<sup>2</sup>S, left-justified, and TDM digital audio interfaces, as well as I<sup>2</sup>C for control.

The AUDINT3 board provides 1.8V DVDD, USB-to-PCM, and USB-to-I<sup>2</sup>C interfaces that are needed to evaluate the DEV board, requiring only a single external power supply for VBAT. The [Simplified EV System Block Diagram](#) details the DEV board and the AUDINT3 board.

The easy-to-use DSM Sound Studio software has a simple, yet powerful graphical user interface (GUI) that breaks down the DSM design process into three basic steps: extract, tune, and evaluate. Additionally, DSM Sound Studio provides for a 7 minute quick demo to hear the DSM difference using the included reference microspeaker.

There is also the MAX98390 evaluation software that provides complete access to all hardware registers.

### Features

- Complete Hardware System with Easy Setup, No Tools or Special Equipment Required
- Precharacterized Reference Microspeaker Included
- Easy-to-Use Graphical User Interfaces Software (Windows® 7/10 Compatible)
- DSM Sound Studio
  - Quick Demo Using Included Speaker
  - Extract: Speaker Parameter Extraction
  - Tune: Full Acoustic Tuning Suite
  - Evaluate: Compare Different Tunings
- MAX98390 Evaluation Software
  - Complete Access to All Hardware Registers

### EV System Contents

- MAX98390C or MAX98390D development board
- Audio Interface Board III
- 5V power supply, 100V to 240V
- Micro-USB cable
- Reference micro speaker
- Temporary adhesive for mounting microspeaker to DEV board

[Ordering Information](#) appears at end of data sheet.

Simplified EV System Block Diagram for MAX98390C

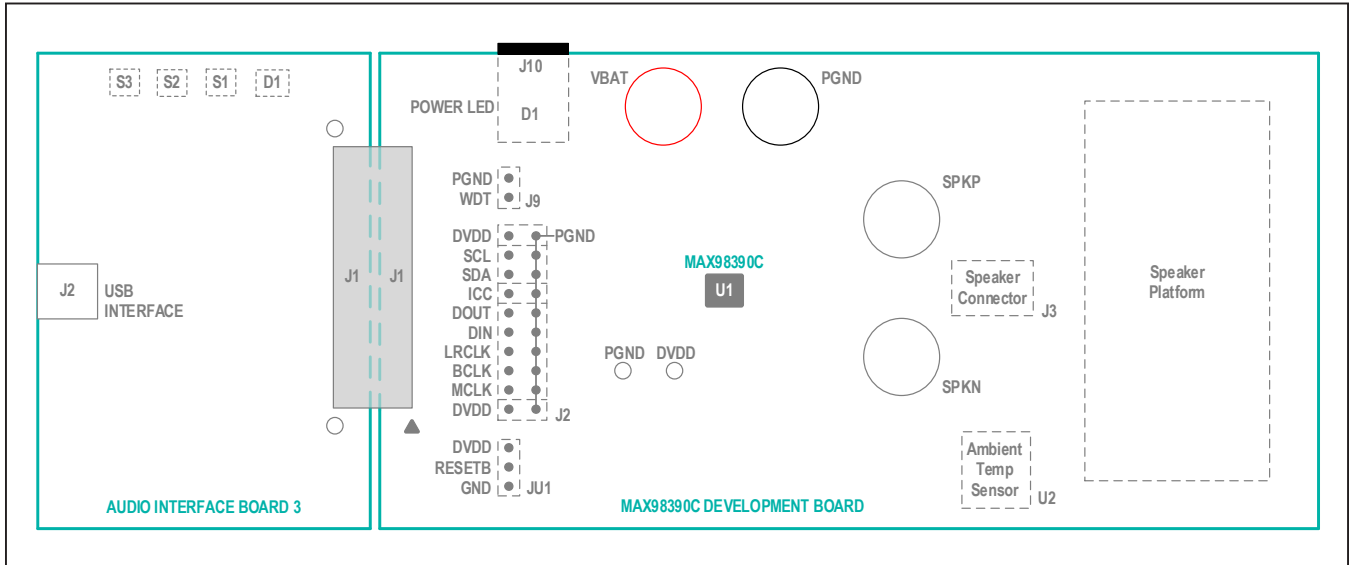

Simplified EV System Block Diagram for MAX98390D

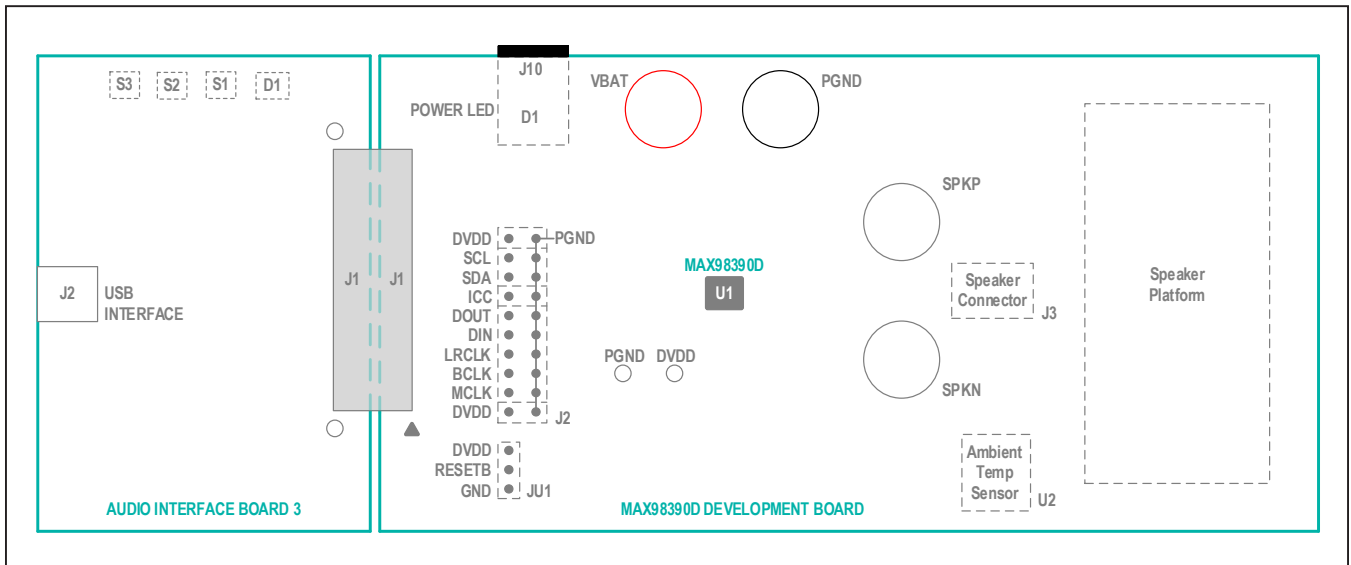

## Software Installation

- 1) For the latest software, login to your MyMaxim account at [maximintegrated.com](http://maximintegrated.com) and navigate to MAX98390 > Design Resources > Software. Download DSMSoundStudio\_vx.x.xx.zip, and MAX98390EVSwSetupvx\_x\_x.zip. Extract each compressed folder by first selecting the folder, click and hold (or right-click) the folder, select Extract All, and then follow the instructions.
- 2) Install the DSM Sound Studio software on your computer by running the program installer DSMSoundStudio\_vx.x.xx.msi. Follow the installer prompts to completion. The application icon, labeled as DSM Sound Studio, is located under **Windows > Maxim Integrated**.
- 3) Install the MAX98390 Evaluation Software by running the program installer MAX98390EVSwSetupvx\_x\_x.exe. Follow the installer prompts to completion. Windows might display a message indicating that this software is from an unknown publisher. This is not an error condition and it is safe to proceed with the installation. The application icon is located at **Windows > Maxim Integrated**.

## Quick Start Guide

### DSM Sound Studio GUI

It is highly recommended to start with DSM Sound Studio. DSM Sound Studio is an easy to use GUI that will walk the user through a quick DSM demo, speaker parameter extraction, acoustic tuning of all the DSM features, and provide for rapid comparison of various tuning profiles. DSM Sound Studio also shows the user how to properly set up the hardware. Refer to *DSM User Guide* <https://www.maximintegrated.com/en/design/technical-documents/userguides-and-manuals/dsm-user-guide.html> for more information.

To launch the DSM Sound Studio application, navigate to **Windows > Maxim Integrated** and click on the **DSM Sound Studio** application icon.

To set or modify the device's hardware configurations such as sample rate, boost parameters, or brown-out detection use the MAX98390 evaluation software (see the [MAX98390 Evaluation Software](#)).

## MAX98390 Evaluation Software

### Required Equipment

- MAX98390C or MAX98390D EV system
  - Audio Interface Board III
  - 5V power supply

- Micro-USB cable
- Microspeaker with enclosure
- USB audio source (e.g., Windows Media Player® or iTunes®)
- User-supplied Windows 7 or Windows 10 PC with an available USB port

### Required Software

- MAX98390 evaluation software application. If not already installed, see the [Software Installation](#) section.

**Note:** In the following sections, software-related items are identified by bolding. Text in **bold** refers to items directly from the evaluation software. Text in **bold and underlined** refers to items from the Windows operating system.

### Reference Material

- MAX98390C/D IC data sheet

### Procedure

The MAX98390C, or the MAX98390D and AUDINT3 boards are fully assembled and tested. Follow the steps below to set up the EV system for device evaluation:

#### AUDINT3 Board Setup

- 1) Connect the DEV board (J1 connector) to the AUDINT3 board (J1 connector).
- 2) With the audio source disabled, connect the USB cable from your computer to the USB port (J2) on the AUDINT3 board. The AUDINT3 board provides the power for DVDD, sourcing 1.8V to the DEV board through the J1 connector.
- 3) The multicolor LED D1 blinks white. When the computer registers the AUDINT3 as a USB device D1 changes to magenta and blinks slowly.

#### DEV Board Setup

- 1) With the 5V power supply unpowered, insert the DC power jack into the DC power connector (J10) located underneath the DEV board.
- 2) Connect the micro speaker leads across the SPKP and SPKN binding posts. Alternatively, use the spring connector terminal (J3) by pressing down the orange tab and inserting the bare speaker wire into the round holes of the connector, releasing the tab to allow the connector to grip the wire. A nonpermanent adhesive is included with the MAX98390C/D evaluation system and can be used to mount the microspeaker to the DEV board on the open space marked with the speaker symbol. The adhesive helps keep the speaker from rattling on the board during the evaluation. Be careful not to

cover any holes in the speaker enclosure when mounting using the temporary adhesive. It is common for microspeaker enclosures to include small holes for pressure equalization.

- 3) Place the shunt on jumper JU1 across pins RESETB and DVDD.

### Test

- 1) Insert the 5V power supply into a wall receptacle.
- 2) Launch the MAX98390 evaluation software and wait while the software connects to the EV system (Figure 1).
- 3) Once the connection is established, the status bar at the bottom of the GUI window should report **USB Connected** and display MAX98390 and revision ID. After the EV system is fully connected, configure the device by loading the **usb\_audio\_48kHz.98390** configuration file. This file can be loaded from **File, Load Register Settings, Pre-Installed Configuration Files**. Scroll down to select. Progress of the register writes can be seen in the Status Bar as a green progress bar, wait for the writes to complete before operating the device.
- 4) Access the Windows Sound settings by **Settings > System > Sound**. Select the output device to be Maxim AUDINT003, it should appear as Speakers (3-Maxim AUDINT003 ADC1.0) or something similar, see Figure 2. On the same page, click on **Sound Control Panel > Playback** tab and ensure that the Default Device is set to Speakers (3-Maxim AUDINT003 ADC1.0) or something similar, as shown in Figure 3.
- 5) Adjust the audio source volume to a low level.
- 6) Enable the audio source and verify that audio is heard through the connected speaker. Adjust the audio source volume as needed.
- 7) Quick start of the evaluation software is now complete.

## Detailed Description of Evaluation Software

The MAX98390 evaluation software is designed to be used only with the MAX98390C/D EV system. The software provides an intuitive GUI for programming the device and includes many features intended to aid in evaluation.

The MAX98390 evaluation software main window (Figure 1) is composed of four main sections: menu bar, communication tool bar, tabbed pages, and a status bar. The menu bar provides additional features to aid evalua-

tion, the toolbar provides basic functionality for communicating with the device, and the status bar provides information about hardware connectivity and communication status. The tabbed pages make up the bulk of the GUI and provide the controls for programming the device's hardware registers.

The **Block Diagram** tab provides access to all the device registers using dialog windows, which contain GUI controls for configuring the device. The dialog windows are opened by clicking on the blocks in the block diagram. The **Control Registers** tab provides direct access to the valid registers from 0x2000–0x23FF, as well as to the revision ID register, 0x24FF. The **DSP Registers** tab provides access to the registers for the 8-band equalizer, the dynamic range compression, the voice coil thermal protection, and the speaker excursion protection. The **Log** tab provides a log of the I<sup>2</sup>C transactions and a tool to read specific registers.

The MAX98390 evaluation software is compatible with Windows 7 and Windows 10 and can be found on Maxim's website. Refer to the MAX98390C/D data sheet for device register information.

### Connect Sequence

When the evaluation software starts for the first time, the program automatically connects to the EV system and attempts to connect to the USB control interface on the AUDINT3 board first. Once that connection is established, it searches for all I<sup>2</sup>C addresses associated with the MAX98390C/D device and populates all detected device addresses in the **Active Device** drop-down list. During this sequence, the text on the **Connect** button automatically changes from **Connect** to **Disconnect**, and the status bar is also updated to reflect the current state of the hardware connection.

Once the EV system is fully connected, the button displays **Disconnect**, and when clicked, it disconnects the software from the hardware. The software can also be disconnected from the hardware by selecting **Device | Disconnect** from the menu bar.

There are two methods to reestablish a connection with the hardware. The first is by selecting **Device | Connect** from the menu bar. This instructs the program to connect to the EV system. The second method is to click the **Connect** button until it displays **Disconnect**, which signifies that the EV system is fully connected.

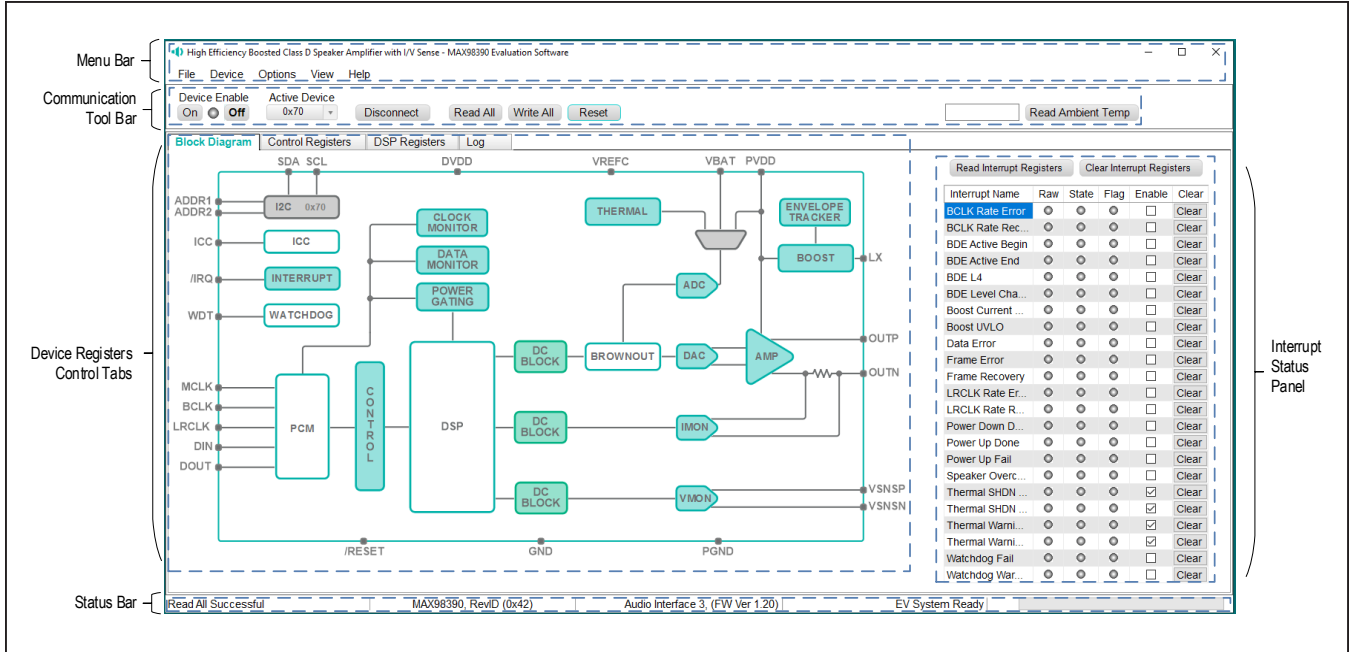

Figure 1. MAX98390 Evaluation Software



Figure 2. Windows Sound Settings



Figure 3. Playback Device

### Communication Tool Bar

The tool bar consists of seven buttons, a drop-down combo box, and a display box. These controls are always accessible, regardless of the active tabbed page. The tool bar is shown in [Figure 4](#) and [Table 1](#) provides details about each control.

### Status Bar

The Status bar is divided into four sections. From left to right: status and alert messages, device part number and revision ID, interface name and firmware version, and evaluation system connection status.

### Interrupt Status Panel

The Interrupt Status panel (not to be confused with the Status bar) displays the state of the **Raw**, **State**, and **Flag** interrupts. This data is read from the Raw\_, State\_,

and Flag\_ interrupt registers (0x2002–0x200A). When the image is red, it indicates that the associated interrupt bit has been set.

The panel also includes checkboxes for each interrupt that are used to enable the link between an interrupt's Flag bit and State bit. When enabled, the Flag bit is set whenever the State bit is set. To clear the State and Flag bits, click on the interrupt's associated **Clear** button.

**Note:**

- Each interrupt source must be enabled for the FLAG column (i.e., flag bits) to be set.
- The IRQ\_EN bit needs to be set for the interrupt to be output on the IRQ pin.



Figure 4. Communication Tool Bar

**Table 1. Communication Tool Bar Controls**

CONTROL	FUNCTION
<b>On</b>	Press to set the Global Enable bit (EN). This enables the device.
<b>Off</b>	Press to clear the Global Enable bit (EN). This disables the device. <b>Note:</b> The software can communicate with a disabled device, as long as its I <sup>2</sup> C interface remains active.
<b>Active Device</b>	Provides a list of detected I <sup>2</sup> C addresses. The displayed address is the active device.
<b>Connect/Disconnect</b>	See the <i>Hardware Connection</i> section for additional details.
<b>Connect</b>	Detected addresses are shown in the <b>Active Device</b> drop-down list.
<b>Disconnect</b>	Press to disconnect from the USB control interface.
<b>Read All</b>	Press to initiate a read of all device registers. The <b>Control Registers</b> and <b>Block Diagram</b> tabs are updated to reflect the read data.
<b>Write All</b>	Press to initiate a write to all device registers, using the settings shown on the <b>Control Registers</b> tab.
<b>Reset</b>	Press to reset device registers to their power-on-reset (POR) state.
<b>Read Ambient Temperature</b>	Press to read the ambient temperature of the application board from external temperature sensor U2. The temperature in degrees Celsius is displayed in the display box to the left. This sensor measures the ambient temperature of the board and is used by the DSM Sound Studio software to set the room temperature value of a tested speaker.



### Block Diagram Tab

The evaluation software uses an interactive block diagram to facilitate the programming of the device. The block diagram also provides a visual representation of the device's functions and current configuration.

There are three types of blocks in the block diagram, and they are identified by the cursor image. The cursor changes to a pointing hand when over a block that opens a dialog window and a full hand to toggle a function. If the cursor does not change when over a block, then it is an inactive block, and is only provided for illustrational purposes.

The color of a diagram block changes depending on the enabled state of the device function(s) associated with that block. An inactive block is grey, a disabled block is white, and an enabled block is teal. Figure 5 shows the block diagram with the device configured for digital audio interface (DAI) (USB audio) input and speaker output.

### Dialog Windows

Dialog windows are associated with specific blocks in the block diagram and contain the controls for configuring the registers associated with that functional block. Open a dialog window by clicking on a dialog block. Figure 7 shows the typical GUI controls that are found on a dialog window.

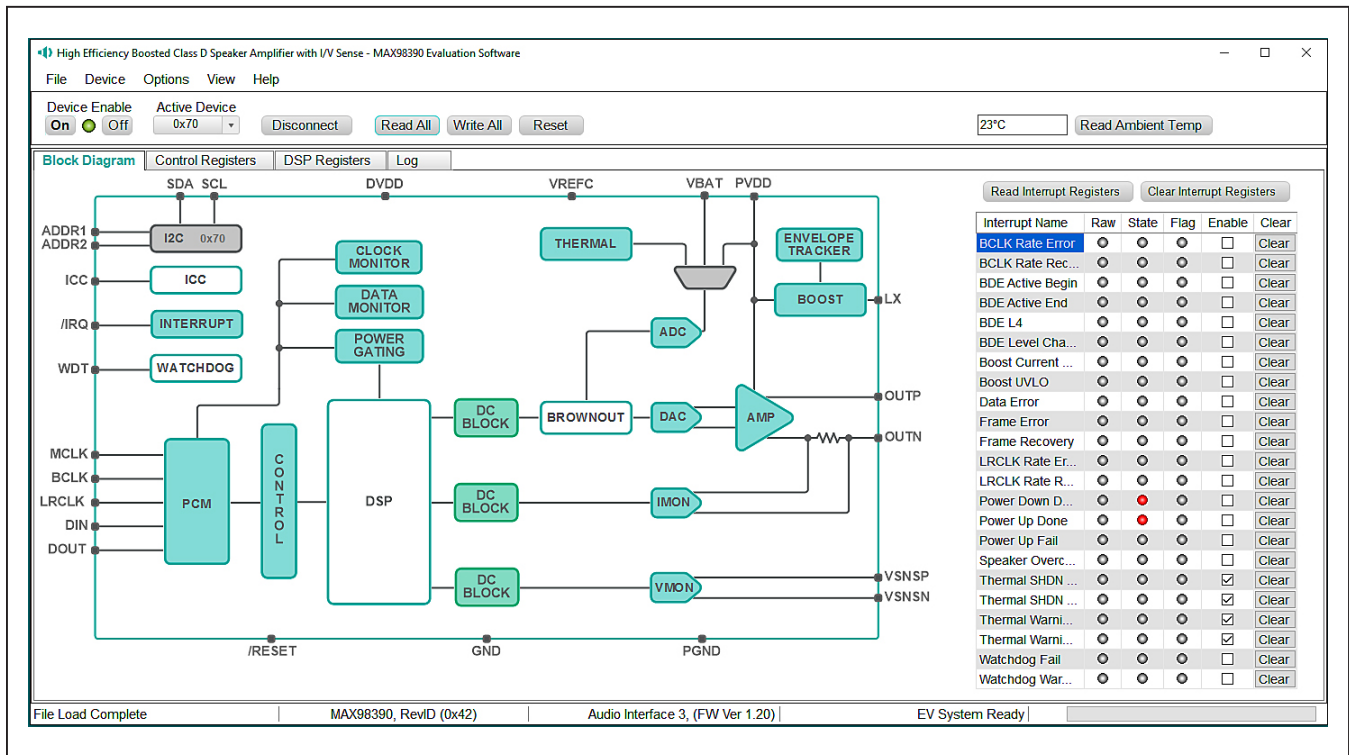

Figure 5. MAX98390 Block Diagram (USB Audio Input to Speaker Output)

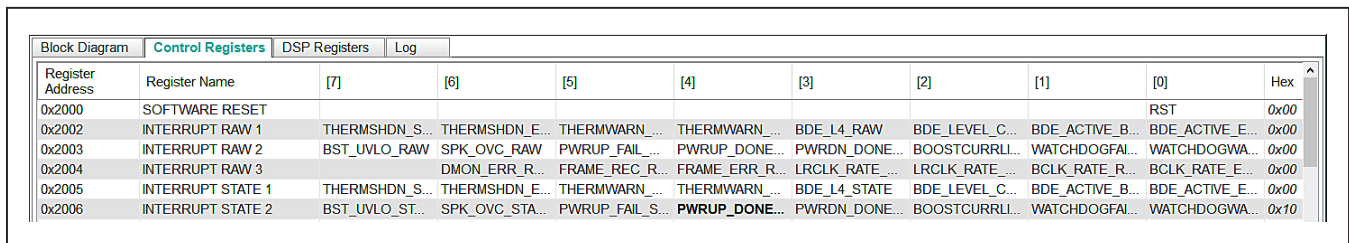

Figure 6. Control Register Tab

**Control Registers Tab**

The **Control Registers** tab provides two methods for configuring the device. As an example, [Figure 6](#) shows the elements of the interrupt registers.

The first configuration method involves clicking on the register’s bit labels. A non-bold bit label indicates that the bit is currently set low. A bold bit label indicates that the bit is currently set high. Clicking on a bit toggles its state and results in a write to that register. This action also updates the value displayed in the register’s edit box, located to the right of the bit labels.

The second configuration method involves entering a hex value in the register’s edit box and then pressing

the **Enter** key; the software automatically configures the device register once the **Enter** key is pressed. The state of the bit labels are then updated to reflect the value shown in the edit box.

**Note:** Trying to write to a read-only bit by clicking/toggling its label or entering a hex value in its edit box updates the GUI, but it does not affect the bit’s value in the device. All read-only bits are updated to reflect their current value in the device by performing a read all operation.

All changes made on this tab are reflected on the **Block Diagram** tab and on any open dialog windows.

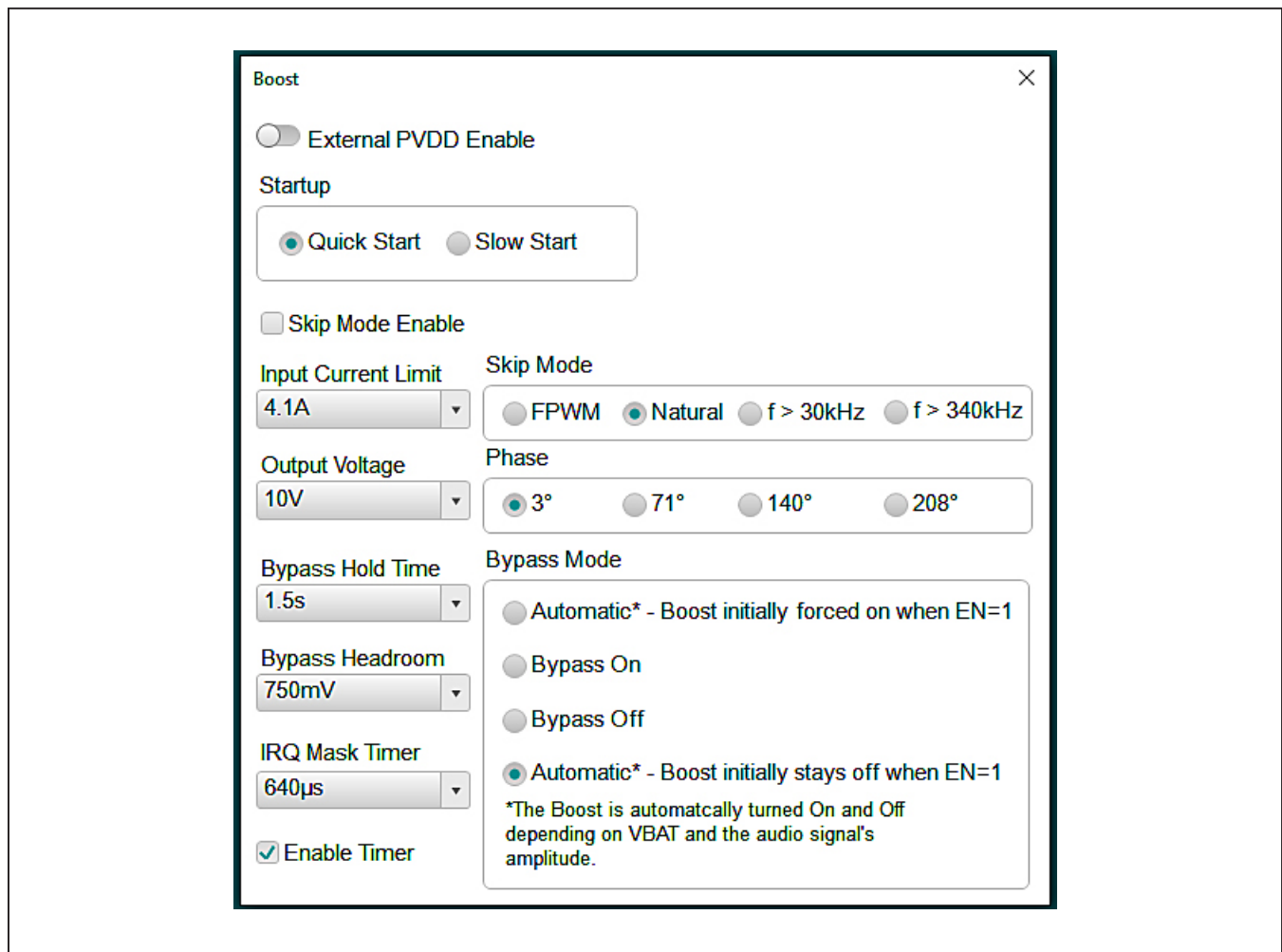

Figure 7. Typical GUI Controls



**Menu Bar**

Table 2 describes all menu bar items with additional information for some menu items provided in the following sections.

**File I/O**

The software's save and load features are accessed from the **File** menu. The **Save Control Register Settings** feature saves the data currently displayed on the **Control Registers** tab.

A configuration file's main purpose is to capture the current state of the device's registers, as displayed on the register tab. This feature makes it easy to program a device to a saved/known state and allows for the sharing of configuration files between users. To facilitate usage, use descriptive file names when saving a configuration file.

The save and load features are functional even when the hardware is not connected. This allows configuration files to be created and opened when hardware is not available. Since the configuration file is automatically generated by the software, it is not meant to be manually formatted and doing so may cause file loading issues. To open a configuration file for viewing purposes only, use a plain text editor.

Select **File > Save Control Register Settings** to create a configuration file. The register address and its data are saved as tab-delimited values and the file is saved with a .98390 extension.

The software has a couple standard configuration files pre-installed. A file can be loaded by selecting **File > Load Register Settings > Pre-Installed Configuration Files**, and using the drop-down menu, select the file, then clicking **Load**.

**Table 2. Menu Bar Items**

MENU ITEM	DESCRIPTION
<b>FILE</b>	
Load Register Settings	Loads a configuration file (as saved by the <b>Save Control Register Settings</b> option or a factory preinstalled file).
Save Control Register Settings	Saves a configuration file containing the current device settings.
Exit	Closes the MAX98390 evaluation software.
<b>DEVICE</b>	
Connect	Runs a connection routine to connect to the evaluation system. First, establish a connection to the AUDINT3 board and then establish a connection to the MAX98390C/D.
Disconnect	Disconnects the PC from the EV system.
Reset	Resets all control registers to their power-on-reset (POR) states.
Read All	Performs a read from all registers and updates the GUI.
Write All	Performs a write to all writeable registers, using the values show on the <b>Control Registers</b> tab and then updates the GUI.
Read Rev ID	Reads the device's revision ID register and updates the status bar.
<b>OPTIONS</b>	
Audio Interface 3 (Advanced Users) F3	Opens a dialog that allows the digital clocks from the AUDINT3 to be enabled or disabled. This allows the user to apply external clocks to the MAX98390C/D without conflicting with the clocks from the AUDINT3.
Interface Selection	Selects the I <sup>2</sup> C hardware interface to either the audio interface or an I <sup>2</sup> C bridge (not supported).
Configuration Mode F4	Opens a dialog that allows multiple MAX98390C/D devices to be selected for configuration through the software. This feature is available only when more than one active device is detected.
Activate Demo Mode	Puts the software in demo mode.
<b>VIEW</b>	
Communication Log	Toggles the Log sheet display in the Device Registers Control Tabs.
<b>HELP</b>	
View Help	Links to technical documents.
About	Provides information about the MAX98390 evaluation software.

### Detailed Description of Hardware

The MAX98390C/D EV system is designed to allow for a thorough evaluation of the MAX98390C/D boosted Class D audio amplifier IC with integrated Dynamic Speaker Management. The EV system includes either the MAX98390C or the MAX98390D development board (DEV board), Maxim’s Audio Interface Board III (AUDINT3), 5V power supply, and a microspeaker.

The DEV board can be evaluated as a standalone board that is driven directly by audio test equipment, powered by multiple external supplies, and configured by an external I<sup>2</sup>C capable controller. To simplify the evaluation, the DEV board can be evaluated with the AUDINT3 board and the included 5V power supply. This hardware combination provides an easy-to-use method for exercising the capabilities of the device with no additional audio equipment.

The AUDINT3 board provides an on-board LDO regulator, USB-to-PCM, and USB-to-I<sup>2</sup>C interfaces. The AUDINT3 LDO regulator is used to power the device’s DVDD supply rail through connector J1. The USB-to-PCM converter accepts a USB audio stream from a USB connected computer and converts that into an I<sup>2</sup>S data stream, allowing for USB audio playback through the MAX98390C/D device. The USB-to-I<sup>2</sup>C interface is the bridge that allows the evaluation software to configure, monitor, and control the I<sup>2</sup>C capable devices on the DEV and AUDINT3 boards.

#### Ambient Temperature Sensor

A temperature sensor, DS7505, is included on the DEV Board. The sensor is connected to the I<sup>2</sup>C bus, permanently set to address 0x90, and is used by the DSM Sound Studio software to measure the ambient room temperature.

#### Measuring Quiescent Current

To accurately measure the quiescent current of the MAX98390C/D, the power LED and temperature sensors can be temporarily disabled by removing resistors R25 and R29. The AUDINT3 should be disconnected from J1, and DVDD (1.8V) must then be powered by an external power supply. I<sup>2</sup>C control and PCM audio can then be connected using J2 on the DEV board. To return to normal operation, reinstall R25 and R29.

#### Power Supplies

The DEV board requires at least two external power supplies when evaluated as a stand-alone board. The power supplies and their ranges are listed in [Table 3](#). The external supply voltages can be connected at the

respective supply test-points and/or binding posts. When using the AUDINT3 board, connect the included 5V power supply to VBAT (J10). The AUDINT3’s on-board LDO regulator powers DVDD on the DEV board. This power is routed to the DEV board through the J1 connector. See the [Digital Audio Interface](#) section.

#### Jumper Selection

The DEV board includes jumper JU1 to facilitate a device reset. [Table 4](#) describes the JU1 configuration options. **Note:** Before starting evaluation, ensure that the jumper is configured as needed.

#### Digital Audio Interface

The device DAI is routed to interface header J2 as well as the AUDINT3 connector J1. The interface headers provide easy access to the device’s PCM bus and the AUDINT3 connector allows for USB audio to be streamed onto the DEV board. See the [USB Audio Input](#) section for details on USB audio streaming and [Table 6](#) for the connector J1 pinout.

#### DAI Header

The DAI header (J2) provides access to the MAX98390C/D master clock (MCLK) input, as well as its PCM bus (BCLK, LRCLK, DIN, and DOUT). This DAI header facilitates evaluation with audio equipment I/O. See [Table 5](#) for the pinout of the DAI headers and [Figure 8](#) for an illustration of how the MAX98390C/D DAI interface is routed through the DAI headers to the AUDINT3 connector.

**Table 3. Power Supplies**

POWER SUPPLY	RANGE (V)
VBAT	2.65V to 5.5V
DVDD	1.71V to 1.89V

**Table 4. Jumper Configuration**

HEADER	SHUNT POSITION	DESCRIPTION
JU1	RESETB to DVDD	Normal operation
	RESETB to GND	Device is reset

**Table 5. DAI Header (Portion of J2)**

SIGNAL	PIN	PIN	SIGNAL
GND	3	4	MCLK
GND	5	6	BCLK
GND	7	8	LRCLK
GND	9	10	DIN
GND	11	12	DOUT

**Table 6. AUDINT3 Connector (J1)**

SIGNAL	PIN	SIGNAL	PIN	SIGNAL	PIN
—	1	AUDINT_MCLK	2	GND	3
BCLK2	4	AUDINT_BCLK	5	GPIO1	6
LRCLK2	7	AUDINT_LRCLK	8	GPIO2	9
DAC2	10	AUDINT_DIN	11	GPIO3	12
ADC2	13	AUDINT_DOUT	14	GPIO4	15
—	16	ID	17	3.3V	18
AVDD	19	DVDD	20	GND	21
HPVD	22	VDDIO	23	GND	24
GND	25	SDA	26	5V	27
—	28	SCL	29	5V	30
GND	31	IRQ	32	RESET	33
—	34	DOUT	35	WDT	36
GND	37	ICC	38	MCLK	39

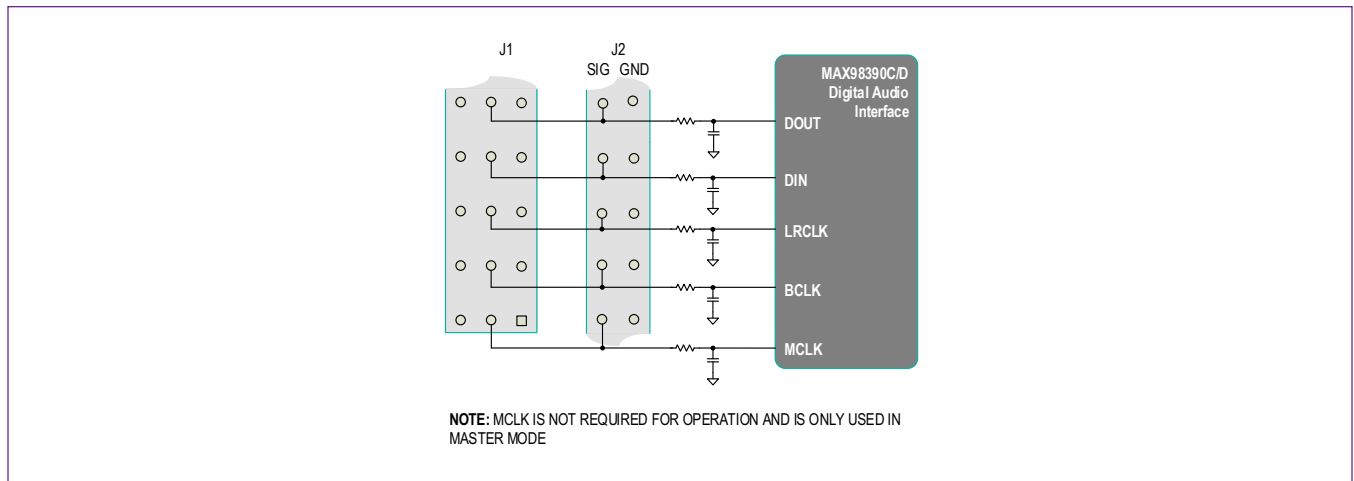

Figure 8. MAX98390C/D DAI Interface Headers (PCM)

**Watch Dog Timer**

Header J9 is present only on the MAX98390C Development Board. It is used to connect the external signal for the hardware mode of the watch dog function. J9 may be left open or shorted if the function is not enabled. See [Table 7](#) for the pinout of header J9.

**Table 7. Watch Dog Timer Header**

SIGNAL	PIN	PIN	SIGNAL
GND	1	2	WDT

### Speaker Output

The MAX98390C/D audio output is routed to the SPKP and SPKN connections on the DEV board. The DEV board is, by default, assembled to allow the MAX98390C/D output to connect directly to a speaker load without the need for filtering.

### EMI Filter

When long speaker cables are used with the MAX98390C/D output, a ferrite bead plus capacitor filter can be installed to prevent excessive EMI radiation. Although it is best to choose filter components based on EMI test results, the combination of 680pF capacitors (C11, C12) and Murata BLM18SG331TN1 ferrite beads (FB1, FB2) generally work well. Before adding the filters to the design, first remove the small PCB traces shorting FB1 and FB2 (see the [MAX98390C EV Kit Schematic](#) and the [MAX98390C EV Kit PCB Layout Diagrams](#)).

### I<sup>2</sup>C Interface

The MAX98390C/D's I<sup>2</sup>C interface is routed to header J2 and connector J1. The J1 connector is for the AUDINT3 board and connects the device's I<sup>2</sup>C interface to the I<sup>2</sup>C interface of the AUDINT3 board. This connection allows the MAX98390 evaluation software to read and write to the device. See [Table 8](#).

A portion of header J2 allows for an external I<sup>2</sup>C controller to connect to the device's I<sup>2</sup>C bus. See [Table 8](#).

### Device Address

The MAX98390C/D I<sup>2</sup>C device address can be configured to one of eight values: 0x70 (default), 0x72, 0x74, 0x76, 0x78, 0x7A, 0x7C, or 0x7E. The device address is set by connecting the device's ADDR1 pin to GND, SDA, SCL, or DVDD and ADDR2 pin to DVDD or GND. This is accomplished by installing 0Ω resistors in one of the R13-R16 locations for ADDR1 and one of the R20-R21 locations for ADDR2. For proper address programming, only one resistor is used for each ADDR pin. R13–R16 and R20–R21 are located on the bottom side of the board and are identified with silk screen. See [Table 9](#) for all I<sup>2</sup>C slave address options.

### Audio Interface Board III

Maxim's Audio Interface Board III (AUDINT3 board) facilitates the evaluation of the DEV board by providing a set of features that can be used to exercise the capabilities of the DEV board without the need for additional audio

equipment. The main components of the AUDINT3 board are LDO supply voltages and USB-to-I<sup>2</sup>C and USB-to-PCM interfaces. The supply voltages allow the DEV board to be evaluated with minimal amount of external supplies. The USB-to-PCM converter allows any computer to be used as an audio source for the DEV board's digital audio PCM interface, and the USB-to-I<sup>2</sup>C interface allows for the use of the MAX98390 evaluation software, making device configuration and monitoring simpler.

The DEV board connects to the AUDINT3 board through connector J1. The physical connections made between the DEV board and AUDINT3 board are listed in [Table 6](#).

### USB Audio Input

To utilize the USB streaming feature of the AUDINT3 board, connect the USB cable from the computer to the micro USB connector J2 on the AUDINT3 board and ensure that the AUDINT3 board is connected to the DEV board.

Once the hardware is ready, use the MAX98390 evaluation software to configure and enable the device for DAI audio playback.

**Table 8. I<sup>2</sup>C Header (Portion of J2)**

SIGNAL	PIN	PIN	SIGNAL
GND	15	16	SDA
GND	17	18	SCL

**Table 9. I<sup>2</sup>C Address Resistors**

RESISTOR (ADDR1)	RESISTOR (ADDR2)	I <sup>2</sup> C ADDRESS
R16 (GND)	R21 (GND)	0x70*
R13 (DVDD)	R21 (GND)	0x72
R15 (SDA)	R21 (GND)	0x74
R14 (SCL)	R21 (GND)	0x76
R16 (GND)	R20 (DVDD)	0x78
R13 (DVDD)	R20 (DVDD)	0x7A
R15 (SDA)	R20 (DVDD)	0x7C
R14 (SCL)	R20 (DVDD)	0x7E

\*Default position.

**Note:** Only one resistor for each ADDR column should be populated.

### Stereo Configuration

For stereo evaluations, a stereo auxiliary kit is available that includes a modified DEV board (stereo companion board), microspeaker, power supply, and 20-pin ribbon cable. See the [Ordering Information](#) section.

The Stereo Companion Board differs from the DEV board in the following ways:

- I<sup>2</sup>C address is set to 0x72.
- Ambient temperature sensor is not installed.
- J1 is not installed.

### Stereo Boards Setup

- 1) Configure the Stereo Companion board the same as the DEV board. See the [DEV Board Setup](#) section.
- 2) Insert the keyed 20-pin ribbon cable into the J2 connector on the Stereo Companion board, then connect the other end of the ribbon cable to the J2 connector on the fully configured DEV board. The ribbon cable bridges the DVDD power to the Stereo Companion board as well as connect DAI, I<sup>2</sup>C, and ICC; no additional AUDINT3 board is required.
- 3) Connect the DEV board (J1 connector) to the AUDINT3 board (J1 connector).
- 4) Insert the DC power jack from one power supply into the DC power connector (J10) located underneath the Stereo Companion board.
- 5) Insert the DC power jack from the remaining power supply into the DC power connector (J10) located underneath the DEV board.

### Stereo Testing

- 1) Insert both 5V power supplies into wall receptacles.
- 2) With the audio source disabled, connect the USB cable from the computer to the USB port (J2) on the AUDINT3 board.
- 3) The multicolor LED D1 on the AUDINT3 blinks white. When the computer registers the AUDINT3 as a USB device D1 changes to magenta and blinks slowly.
- 4) Launch DSM Sound Studio and follow the prompts.
- 5) For further refinement of the hardware configuration, launch the MAX98390 evaluation software. To select a device to configure, use the **Active Device** pulldown menu located in the top banner of the GUI. Once a device is selected, click the **Read All** button to refresh the settings of the GUI.

### Ordering Information

PART	TYPE
MAX98390CEVSYS#	Complete Evaluation System for the MAX98390C
MAX98390C-ST-AUX#	Add-on board and supplies for stereo applications with the MAX98390C. Requires MAX98390CEVSYS#.
MAX98390DEVSYS#	Complete Evaluation System for the MAX98390D
MAX98390D-ST-AUX#	Add-on board and supplies for stereo applications with the MAX98390D. Requires MAX98390DEVSYS#.

#Denotes RoHS compliant.

MAX98390C EV Kit Bill of Materials

ITEM	QTY	REF DES	VAR STATUS	MAXINV	MFG PART #	MANUFACTURER	VALUE	DESCRIPTION
1	2	C1, C24	Pref	20-000U1-D5	C0201C104K9PAC; GRM033R60J104KE19; C0603X5R0J104K030BC; C0201X5R6R3-104KNP	KEMET;MURATA; VENKEL;TDK	0.1µF	CAPACITOR; SMT (0201); CERAMIC CHIP; 0.1µF; 6.3V; TOL = 10%; MODEL = X5R; TG = -55°C TO +85°C; TC = +/-
2	1	C2	Pref	20-000U1-H9	GRM033R61A104KE15; LMK063BJ104KP	MURATA; TAIYO YUDEN	0.1µF	CAPACITOR; SMT (0201); CERAMIC CHIP; 0.1µF; 10V; TOL = 10%; MODEL =; TG = -55°C TO +85°C; TC = X5R
3	2	C3, C4	Pref	20-0010U-BA12	GRM155R61A106ME44; GRM155R61A106ME11; 0402ZD108MAT2A; CL05A106MP5NUNC	MURATA;MURATA; AVX;SAMSUNG	10µF	CAPACITOR; SMT (0402); CERAMIC CHIP; 10µF; 10V; TOL = 20%; TG = -55°C TO +85°C; TC = X5R
4	2	C5, C6	Pref	20-0010U-P7	C1608X5R1E106M080AC; CL10A106M8NRNC; GRM188R61E106MA73; ZRB18AR61E106MED1; GRT188R61E106ME13	TDK; SAMSUNG ELECTRONICS; MURATA;MURATA	10µF	CAPACITOR; SMT (0603); CERAMIC CHIP; 10µF; 25V; TOL = 20%; TG = -55°C TO +85°C; TC = X5R
5	1	C7	Pref	20-0001U-B8	C0402C105K8PAC; CC0402KRX5R6BB105	KEMET;YAGEO	1µF	CAPACITOR; SMT (0402); CERAMIC CHIP; 1µF; 10V; TOL = 10%; TG = -55°C TO +85°C; TC = X5R
6	1	C9	Pref	20-000U1-BA99	GRM033C71C104KE14	MURATA	0.1µF	CAPACITOR; SMT (0201); CERAMIC CHIP; 0.1µF; 16V; TOL = 10%; TG = -55°C TO +125°C; TC = X7S
7	5	C10, C17, C19-C21	Pref	20-0018P-27	C0402C180J5GAC; GRM1555C1H180JAD1; C1005C0G1H180J050BA	KEMET;MURATA;TDK	18PF	CAPACITOR; SMT (0402); CERAMIC CHIP; 18PF; 50V; TOL = 5%; TG = -55°C TO +125°C; TC = C0G
8	1	C18	Pref	20-0047U-J7	GRM32ER61C476KE15	MURATA	47µF	CAPACITOR; SMT (1210); CERAMIC CHIP; 47µF; 16V; TOL = 10%; MODEL = GRM SERIES; TG = -55°C TO +85°C; TC = X5R ; NOTE:NOT RECOMMENDED DUE TO FLUCTUATING AND EXTENDING LEAD TIME
9	1	C25	Pref	20-0001U-73	GRM033R60J105MEA2; C0603X5R0J105M030; CL03A105MQ3CSN	MURATA;TDK; SAMSUNG	1µF	CAPACITOR; SMT (0201); CERAMIC CHIP; 1µF; 6.3V; TOL = 20%; MODEL = GRM SERIES; TG = -55°C TO +85°C; TC = X5R
10	1	D1	Pref	30-LTSTC190KGKT-00	LTST-C190KGKT	LITE-ON ELECTRONICS INC.	LTST- C190KGKT	DIODE; LED; SMT (0603); PIV = 5V; IF = 0.03A
11	3	DVDD, PGND3, PGND4	Pref	EH111000002165	5023	KEYSTONE	N/A	TEST POINT; PIN DIA = 0.100IN; TOTAL LENGTH = 0.200IN; BOARD HOLE = 0.0725IN; PHOSPHOR BRONZE WIRE SILVER PLATE FINISH
12	1	J1	Pref	01-TSW11308GTRA39P-19	TSW-113-08-G-T-RA	SAMTEC	TSW-113-08- G-T-RA	EVKIT PART; CONNECTOR; MALE; THROUGH HOLE; 0.025IN SQ POST HEADER; RIGHT ANGLE; 39PINS; MODIFY PIN NUMBERING ARRANGEMENT
13	1	J2	Pref	01-SBH11PBPCD10STBK20P-21	SBH11-PBPC-D10-ST-BK	SULLINS ELECTRONICS CORP	SBH11-PBPC- D10-ST-BK	CONNECTOR; MALE; THROUGH HOLE; HEADER; STRAIGHT; 20PINS
14	1	J3	Pref	EH111000001242	1790283	PHOENIX CONTACT	1790283	CONNECTOR; FEMALE; THROUGH HOLE; GREEN TERMINAL BLOCK; PUSH-IN SPRING CONNECTION; RIGHT ANGLE; 2PINS
15	5	J4, PGND6, SPKN2, SPKP2, VBAT1	Pref	01-9020BUS20AWG-00	9020 BUSS	WEICO WIRE	MAXIMPAD	EVK KIT PARTS; MAXIM PAD; WIRE; NATURAL; SOLID; WEICO WIRE; SOFT DRAWN BUS TYPE-S; 20AWG
16	1	J9	Pref	01-PEC02SAAN2P-21	PEC02SAAN	SULLINS	PEC02SAAN	CONNECTOR; MALE; THROUGH HOLE; BREAKAWAY; STRAIGHT; 2PINS
17	1	J10	Pref	01-EJ503A-27	EJ503A	MEMORY PROTECTION DEVICES INC	EJ503A	CONNECTOR; FEMALE; THROUGH HOLE; DC JACK; 5.5MM OD; 2.1MM ID; POSITIVE TIP CONNECTOR; RIGHT ANGLE; 3PINS
18	1	JU1	Pref	01-PEC03SAAN3P-21	PEC03SAAN	SULLINS	PEC03SAAN	CONNECTOR; MALE; THROUGH HOLE; BREAKAWAY; STRAIGHT; 3PINS
19	1	L1	Pref	50-0001U-SM58	PIFE32251B-1R0MS	CYNTec	1UH	INDUCTOR; SMT (1210); FERRITE BOBBIN CORE; 1UH; TOL = +/-20%; 4.7A
20	4	MH1-MH4	Pref	02-MS440014P-02	4C25MXPS; PMSSS4400025PH; 9900; 91735A102	MCMaster-CARR	N/A	MACHINE SCREW; PHILLIPS; PAN; 4-40; 1/4IN; 18-8 STAINLESS STEEL
21	2	MTH1, MTH2	Pref	02-MS440038P-02	91772A108; PHILLIPS-PAN_4-40X3/8IN; PMSSS4400038PH; 9901	GENERIC PART	N/A	MACHINE SCREW; PHILLIPS; PAN; 4-40; 3/8IN; 18-8 STAINLESS STEEL; NOTE: SET TO OBSOLETE FOR PART NUMBER CORRECTION. KINDLY REFER TO PART NUMBER 91772A108;9901
22	4	PGND, SPKN, SPKP, VBAT	Pref	02-TS14321132BP-01	111-2223-001	EMERSON NETWORK POWER	111-2223-001	MACHINE SCREW; THUMBSREW; BANANA; 1/4-32IN; 11/32IN; NICKEL PLATED BRASS
23	1	PVDD	Pref	02-TPMINI5002-00	5002	KEYSTONE	N/A	TEST POINT; PIN DIA=0.1IN; TOTAL LENGTH=0.3IN; BOARD HOLE=0.04IN; WHITE; PHOSPHOR BRONZE WIRE SILVER; NOT FOR COLD TEST
24	1	R1	Pref	80-0010K-49B	CRCW040210KJLN	VISHAY DALE	10K	RESISTOR; 0402; 10K.; 5%; 200PPM; 0.063W; THICK FILM



MAX98390C EV Kit Bill of Materials (continued)

ITEM	QTY	REF DES	VAR STATUS	MAXINV	MFG PART #	MANUFACTURER	VALUE	DESCRIPTION
25	8	R5, R6, R16, R21, R23-R25, R28	Pref	80-0000R-26A	ERJ-2GE0R00	PANASONIC	0	RESISTOR; 0402; 0Ω; 0%; JUMPER; 0.10W; THICK FILM
26	5	R7-R11	Pref	80-0051R-49A	CRCW040251R0JN	VISHAY DALE	51	RESISTOR; 0402; 51Ω; 5%; 200PPM; 0.063W; THICK FILM
27	1	R27	Pref	80-0014K-18	ERJ-2RF140Z	PANASONIC	14K	RESISTOR; 0402; 14KΩ; 1%; 100PPM; 0.10W; THICK FILM
28	1	R29	Pref	80-001K2-23	CRCW04021K20FK; 9C04021A1201LF; MCR01M2PF1201	VISHAY DALE; VISHAY DALE; ROHM SEMICONDUCTOR	1.2K	RESISTOR; 0402; 1.2K; 1%; 100PPM; 0.0625W; THICK FILM
29	1	SU1	Pref	02-JMPFS1100B-00	S1100-B;SX1100-B; STC02SYAN	KYCON;KYCON; SULLINS ELECTRONICS CORP.	SX1100-B	TEST POINT; JUMPER; STR; TOTAL LENGTH = 0.24IN; BLACK; INSULATION = PBT;PHOSPHOR BRONZE CONTACT = GOLD PLATED
30	1	U1	Pref	00-SAMPLE-01	MAX98390CEWX+	MAXIM	MAX98390CEWX+	EVKIT PART - IC; MAX98390; PACKAGE CODE: W362G2+1; PACKAGE OUTLINE: 21-100287
31	1	U2	Pref	10-DS7505U-U	DS7505U+	MAXIM	DS7505U+	IC; DTHM; DIGITAL THERMOMETER AND THERMOSTAT; UMUX8
32	1	PCB	—	N/A	MAX98390C_APPS_A	MAXIM	PCB	PCB;MAX98390C_APPS_A
<b>TOTAL</b>	<b>63</b>							

DO NOT PURCHASE(DNP)								
ITEM	QTY	REF DES	VAR STATUS	MAXINV	MFG PART #	MANUFACTURER	VALUE	DESCRIPTION
1	17	ADDR1, ADDR2, BCLK, DIN, DOUT, ICC, IRQ, LRCLK, LX, MCLK, PGND2, SCL, SDA, VREFC, VSNP, VSNP, WDT	DNP	02-TPMIN5002-00	5002	KEYSTONE	N/A	TEST POINT; PIN DIA=0.1IN; TOTAL LENGTH = 0.3IN; BOARD HOLE = 0.04IN; WHITE; PHOSPHOR BRONZE WIRE SILVER; NOT FOR COLD TEST
2	1	C8	DNP	20-0010U-BA12	GRM155R61A106ME44; GRM155R61A106ME11; 0402ZD106MAT2A; CL05A106MP5NUNC	MURATA;MURATA; AVX;SAMSUNG	10UF	CAPACITOR; SMT (0402); CERAMIC CHIP; 10μF; 10V; TOL = 20%; TG = -55°C TO +85°C; TC=X5R
3	4	C11-C14	DNP	N/A	N/A	N/A	OPEN	PACKAGE OUTLINE 0201 NON-POLAR CAPACITOR - EVKIT
4	2	C15, C16	DNP	N/A	N/A	N/A	OPEN	PACKAGE OUTLINE 0402 NON-POLAR CAPACITOR - EVKIT
5	2	C22, C23	DNP	20-0047U-BA60	PSLB31A476M5HF; 10TPE47MAZB	NEC TOKIN;PANASONIC	4μF	CAPACITOR; SMT (3528); TANTALUM CHIP; 47UF; 10V; TOL = 20%; TG = -55°C TO +105°C
6	2	FB1, FB2	DNP	N/A	N/A	N/A	OPEN	PACKAGE OUTLINE 0402 FERRITE BEAD - EVKIT
7	1	J8	DNP	01-PEC02DAANP-21	PEC02DAAN	SULLINS ELECTRONIC CORP.	PEC02DAAN	CONNECTOR; MALE; THROUGH HOLE; BREAKAWAY; STRAIGHT; 4PINS
8	1	L1A	DNP	50-0001U-0WW	74406042010	WURTH ELECTRONICS INC.	1μH	INDUCTOR; SMT; SHIELDED; 1μH; 30%; 4.47A;NOTE:PURCHASE DIRECT FROM THE MANUFACTURER
9	1	OUT	DNP	01-PEC02SAANP-21	PEC02SAAN	SULLINS	PEC02SAAN	CONNECTOR; MALE; THROUGH HOLE; BREAKAWAY; STRAIGHT; 2PINS
10	9	R2-R4, R13-R15, R17, R18, R20	DNP	N/A	N/A	N/A	OPEN	PACKAGE OUTLINE 0402 RESISTOR - EVKIT
11	1	R19	DNP	N/A	N/A	N/A	SHORT	PACKAGE OUTLINE 0603 RESISTOR - EVKIT
12	2	R22, R12	DNP	N/A	N/A	N/A	OPEN	PACKAGE OUTLINE 0603 RESISTOR - EVKIT
13	1	R26	DNP	80-0000R-26A	ERJ-2GE0R00	PANASONIC	0	RESISTOR; 0402; 0Ω; 0%; JUMPER; 0.10W; THICK FILM
14	1	SPKN1	DNP	02-TPMIN5001-00	5001	KEYSTONE	N/A	TEST POINT; PIN DIA = 0.1IN; TOTAL LENGTH = 0.3IN; BOARD HOLE = 0.04IN; BLACK; PHOSPHOR BRONZE WIRE SILVER PLATE FINISH; RECOMMENDED FOR BOARD THICKNESS = 0.062IN; NOT FOR COLD TEST
15	1	SPKP1	DNP	02-TPMIN5000-00	5000	KEYSTONE	N/A	TEST POINT; PIN DIA=0.1IN; TOTAL LENGTH = 0.3IN; BOARD HOLE = 0.04IN; RED; PHOSPHOR BRONZE WIRE SILVER PLATE FINISH; RECOMMENDED FOR BOARD THICKNESS = 0.062IN; NOT FOR COLD TEST
<b>TOTAL</b>	<b>46</b>							

PACKOUT (These are purchased parts but not assembled on PCB and will be shipped with PCB)								
ITEM	QTY	REF DES	VAR STATUS	MAXINV	MFG PART #	MANUFACTURER	VALUE	DESCRIPTION
1	4	MH1-MH4	Pref	02-SO440012H-01	MCH_SO_F_HEX_4-40X1/2	GENERIC PART	N/A	STANDOFF; FEMALE-THREADED; HEX; 4-40; 1/2IN; ALUMINUM
<b>TOTAL</b>	<b>4</b>							

MAX98390C EV Kit Schematic Diagram

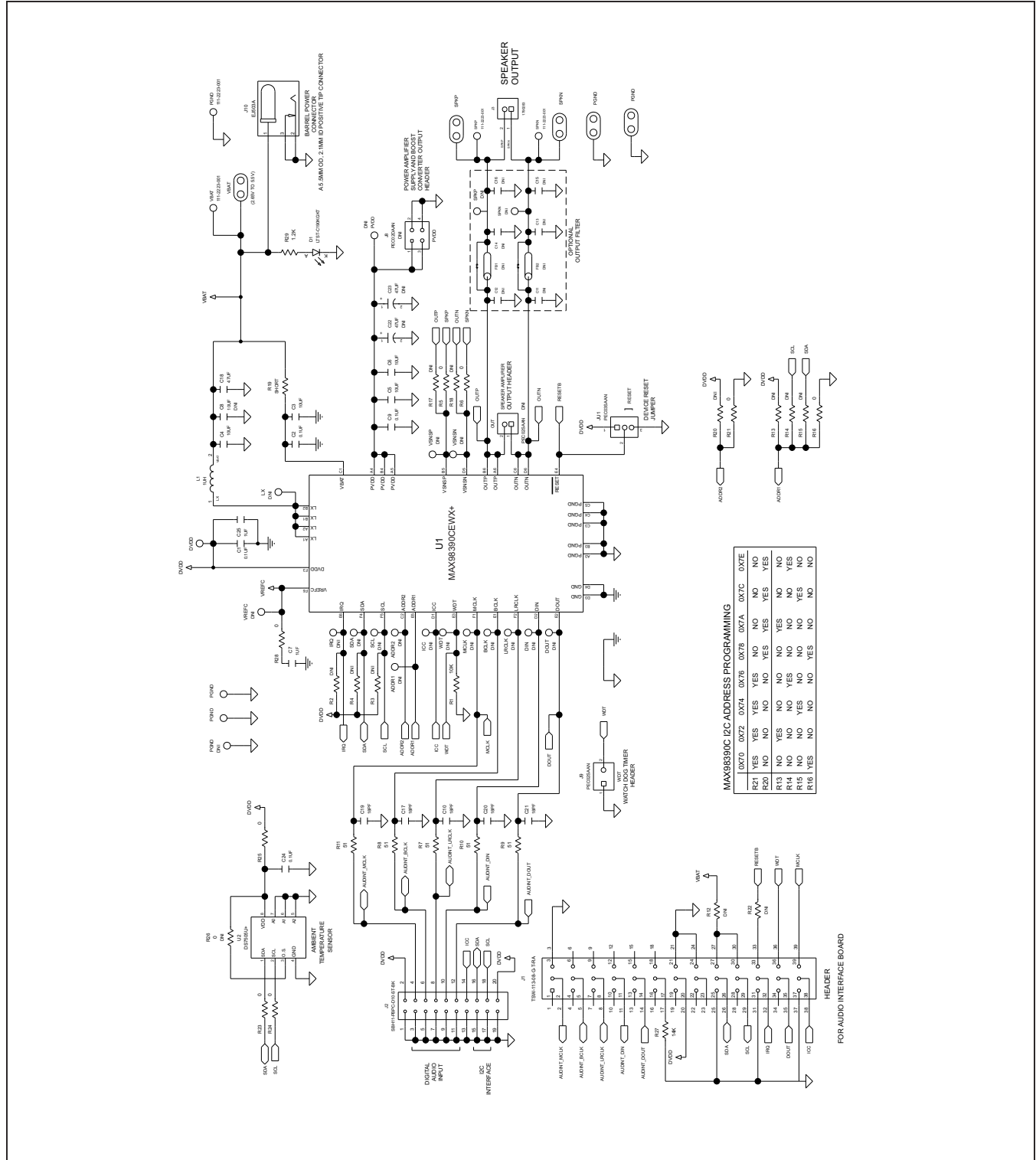

MAX98390C EV Kit PCB Layout Diagrams

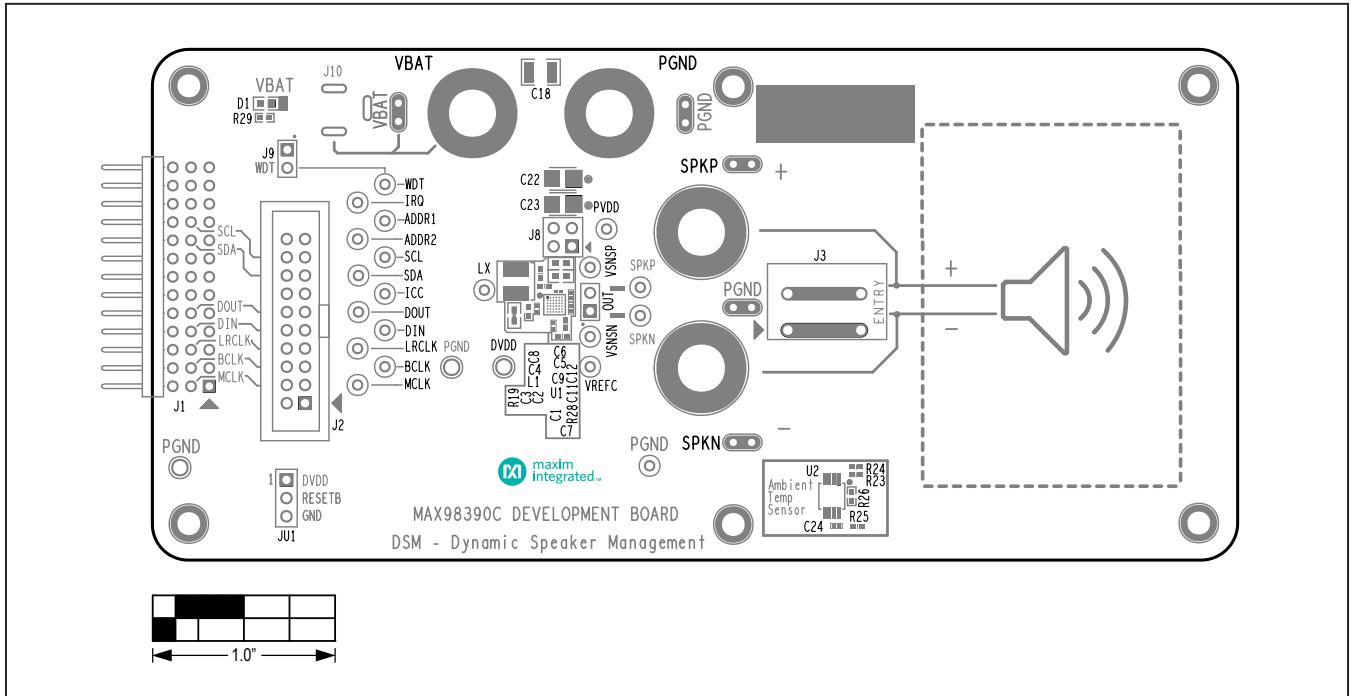

MAX98390C EV Kit Component Placement Guide—Top Silkscreen

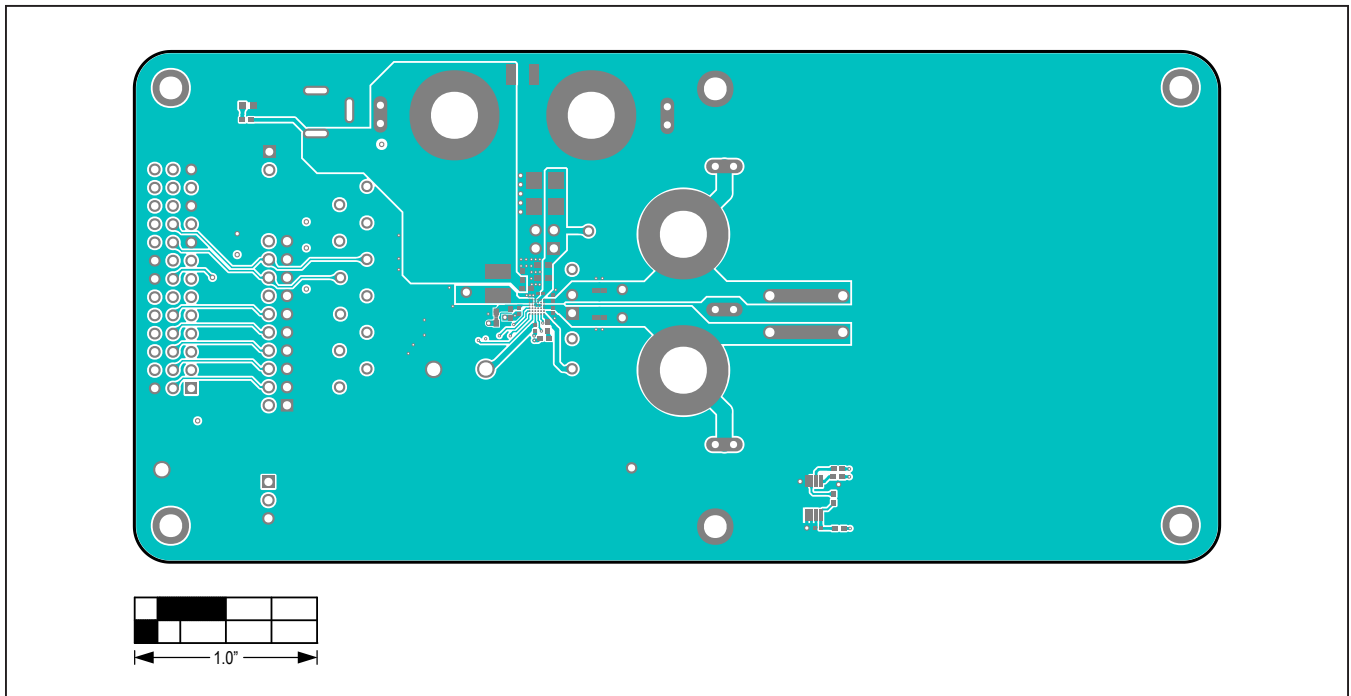

MAX98390C EV Kit PCB Layout—Top View

MAX98390C EV Kit PCB Layout Diagrams (continued)

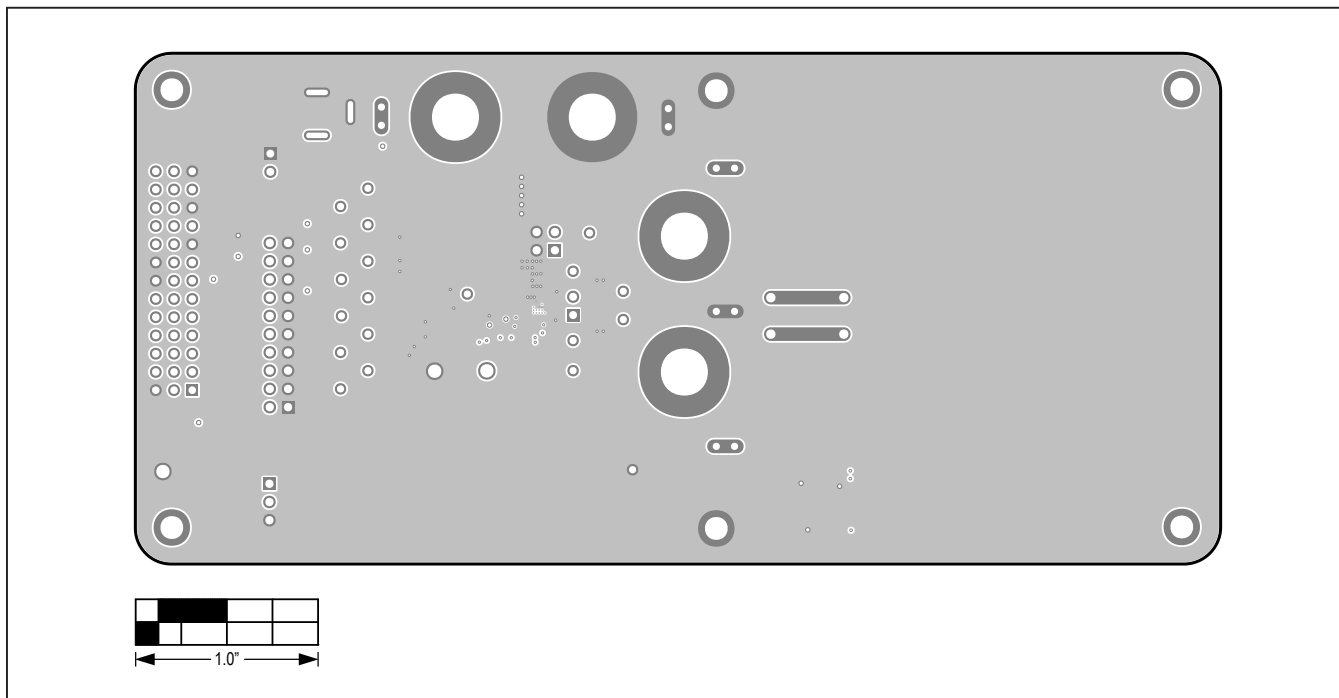

MAX98390C EV Kit PCB Layout—Inner 1

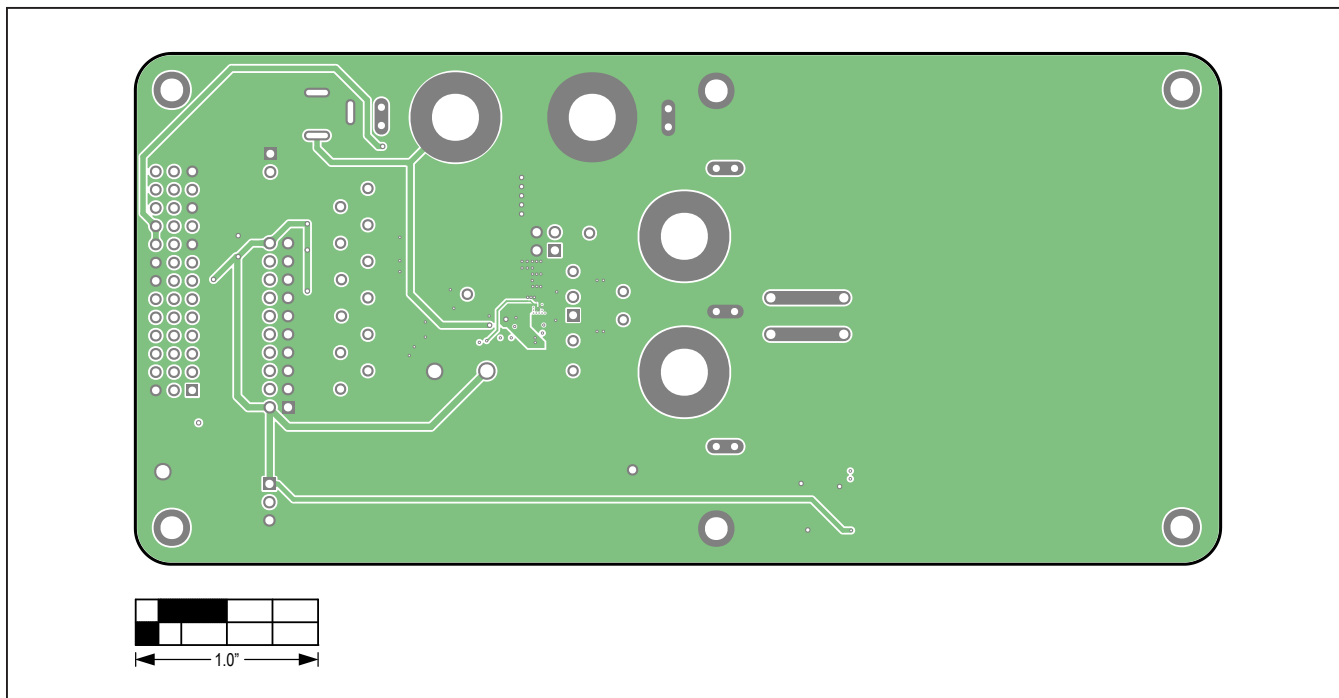

MAX98390C EV Kit PCB Layout—Inner 2

MAX98390C EV Kit PCB Layout Diagrams (continued)

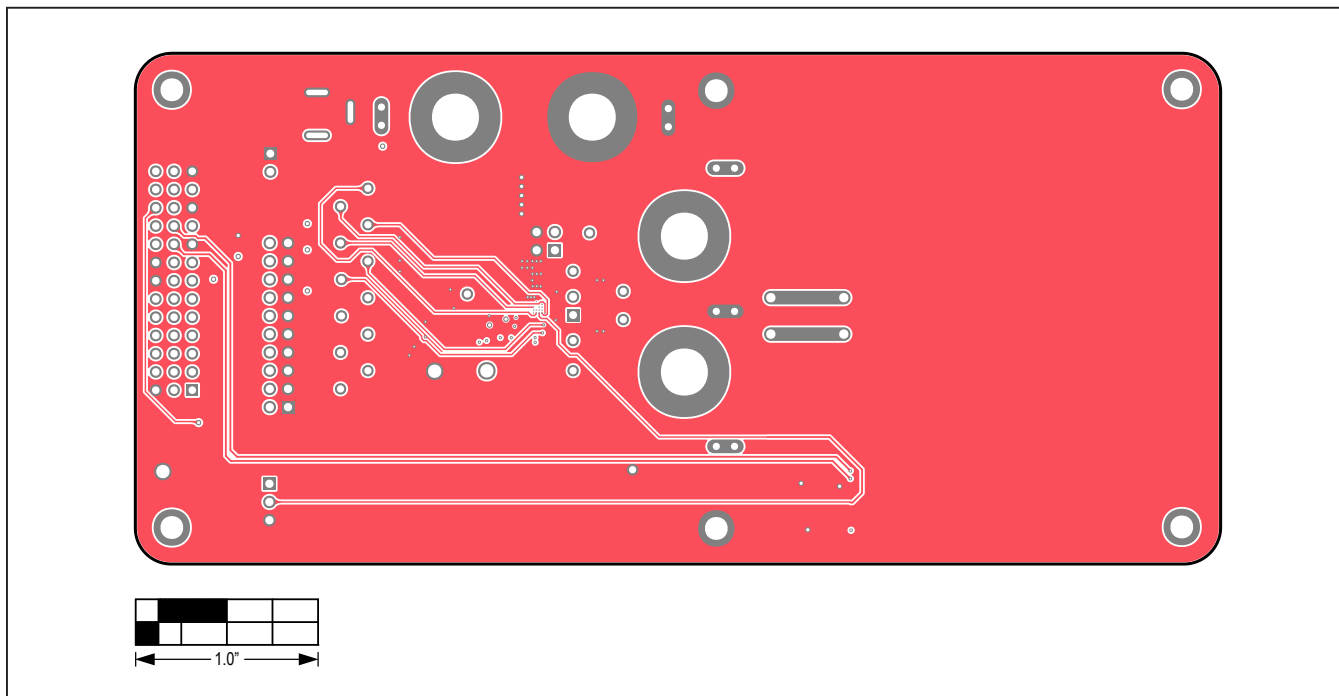

MAX98390C EV Kit PCB Layout—Inner 3

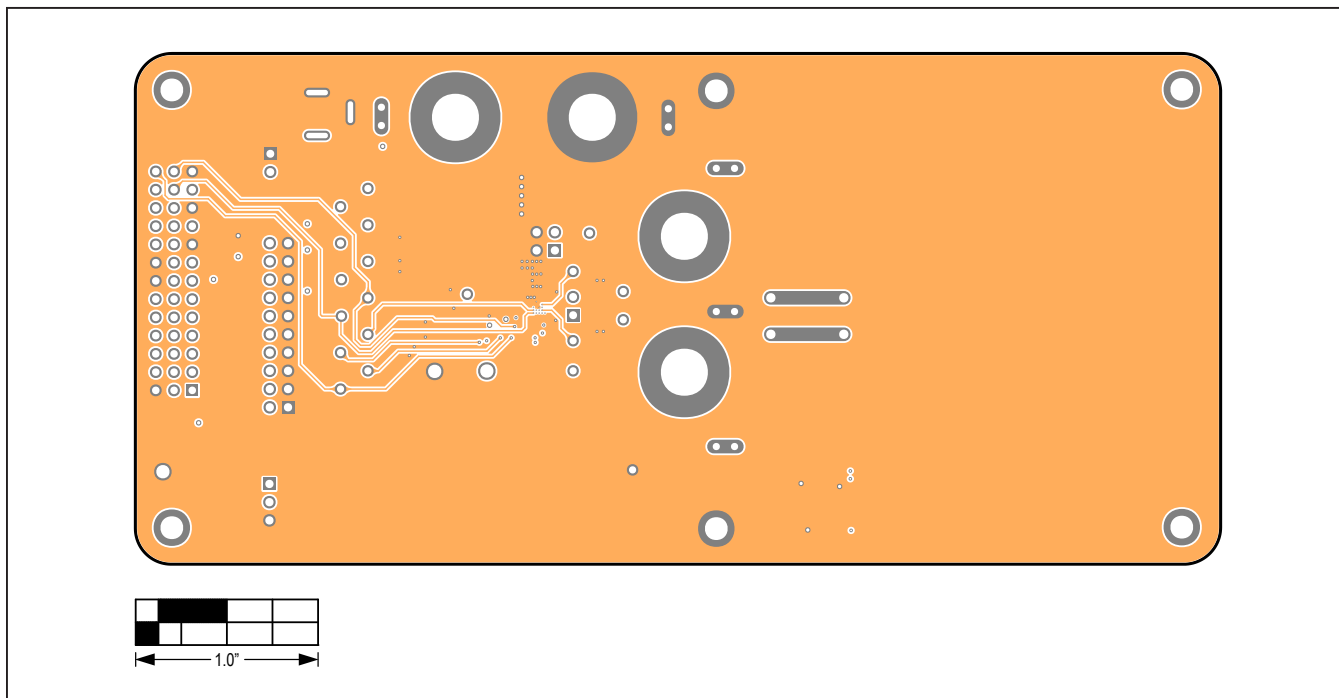

MAX98390C EV Kit PCB Layout—Inner 4

MAX98390C EV Kit PCB Layout Diagrams (continued)

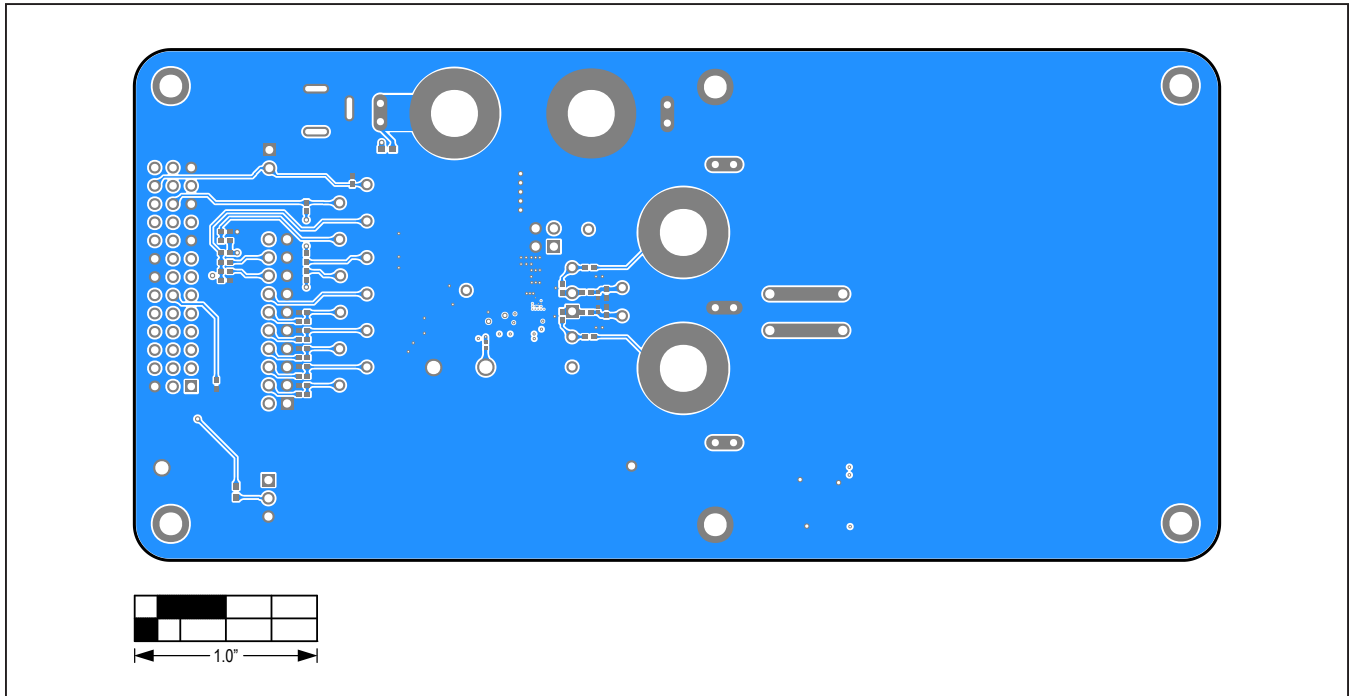

MAX98390C EV Kit PCB Layout—Bottom View

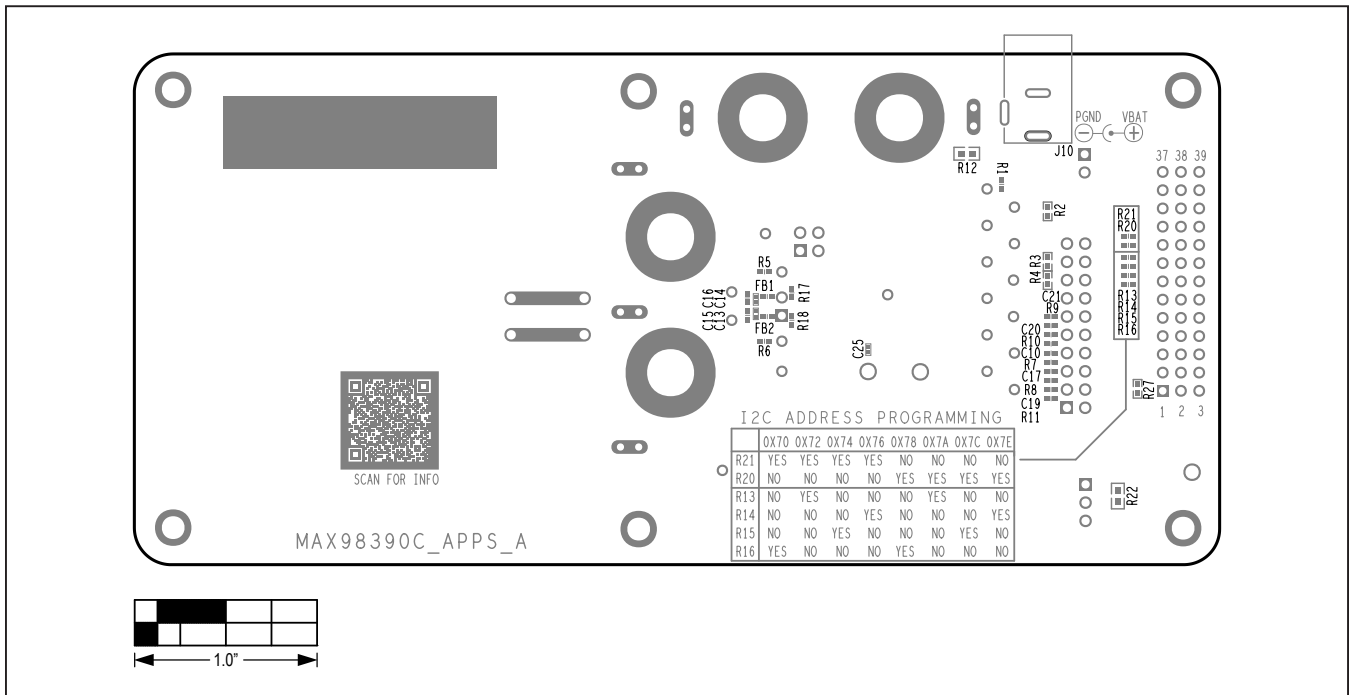

MAX98390C EV Kit Component Placement Guide—Bottom Silkscreen



MAX98390D EV Kit Bill of Materials Diagram

ITEM	QTY	REF DES	VAR STATUS	MAXINV	MFG PART #	MANUFACTURER	VALUE	DESCRIPTION
1	2	C1, C24	Pref	20-000U1-D5	C0201C104K9PAC; GRM033R60J104KE19; C0603X5R0J104K030BC; C0201X5R6R3-104KNP	KEMET;MURATA; VENKEL;TDK	0.1µF	CAPACITOR: SMT (0201); CERAMIC CHIP; 0.1µF; 6.3V; TOL = 10%; MODEL=X5R; TG = -55°C TO +85°C; TC=+/
2	1	C2	Pref	20-000U1-H9	GRM033R61A104KE15; LMK063B1104KP	MURATA; TAIYO YUDEN	0.1µF	CAPACITOR: SMT (0201); CERAMIC CHIP; 0.1µF; 10V; TOL = 10%; MODEL=-; TG = -55°C TO +85°C; TC=X5R
3	2	C3, C4	Pref	20-0010U-BA12	GRM155R61A106ME44; GRM155R61A106ME11; 0402ZD106MAT2A; CL05A106MP5NUNC	MURATA;MURATA; AVX;SAMSUNG	10µF	CAPACITOR: SMT (0402); CERAMIC CHIP; 10µF; 10V; TOL = 20%; TG = -55°C TO +85°C; TC=X5R
4	2	C5, C6	Pref	20-0010U-P7	C1608X5R1E106M080AC; CL10A106MABNRNC; GRM188R61E106MA73; ZRB18AR61E106ME01; GRT188R61E106ME13	TDK; SAMSUNG ELECTRONICS; MURATA;MURATA	10µF	CAPACITOR: SMT (0603); CERAMIC CHIP; 10µF; 25V; TOL = 20%; TG = -55°C TO +85°C; TC=X5R
5	1	C7	Pref	20-0001U-19	C0402X5R6R3-105KNP; C1005X5R0J105K050BB; GRM155R60J105KE19; JMK105BJ105KV-F; JMK105BJ105KVHF	VENKEL LTD;TDK; MURATA;TAIYO YUDEN; TAIYO YUDEN	1µF	CAPACITOR: SMT (0402); CERAMIC CHIP; 1µF; 6.3V; TOL = 10%; TG = -55°C TO +85°C; TC = X5R; NOT RECOMMENDED FOR NEW DESIGN-USE 20-0001U-B8
6	1	C9	Pref	20-000U1-BA99	GRM033C71C104KE14	MURATA	0.1µF	CAPACITOR: SMT (0201); CERAMIC CHIP; 0.1µF; 16V; TOL = 10%; TG = -55°C TO +125°C; TC=X7S
7	5	C10, C17, C19-C21	Pref	20-0018P-27	C0402C180J5GAC; GRM1555C1H180JA01; C1005C0G1H180J050BA	KEMET;MURATA;TDK	18PF	CAPACITOR: SMT (0402); CERAMIC CHIP; 18PF; 50V; TOL = 5%; TG = -55°C TO +125°C; TC=COG
8	1	C18	Pref	20-0047U-17	GRM32ER61C476KE15	MURATA	47µF	CAPACITOR: SMT (1210); CERAMIC CHIP; 47µF; 16V; TOL = 10%; MODEL = GRM SERIES; TG = -55°C TO +85°C; TC = X5R; NOTE:NOT RECOMMENDED DUE TO FLUCTUATING AND EXTENDING LEAD TIME
9	1	C25	Pref	20-0001U-73	GRM033R60J105ME42; C0603X5R0J105M030; CL03A105M03CSN	MURATA;TDK; SAMSUNG	1µF	CAPACITOR: SMT (0201); CERAMIC CHIP; 1µF; 6.3V; TOL = 20%; MODEL = GRM SERIES; TG = -55°C TO +85°C; TC = X5R
10	1	D1	Pref	30-LTSTC190KGKT-00	LTST-C190KGKT	LITE-ON ELECTRONICS INC.	LTST-C190KGKT	DIODE; LED; SMT (0603); PIV = 5V; IF = 0.03A
11	3	DVDD, PGND3, PGND4	Pref	EH111000002165	5023	KEYSTONE	N/A	TEST POINT; PIN DIA = 0.100IN; TOTAL LENGTH = 0.200IN; BOARD HOLE = 0.0725IN; PHOSPHOR BRONZE WIRE SILVER PLATE FINISH
12	1	J1	Pref	01-TSW11308GTRA39P-19	TSW-113-08-G-T-RA	SAMTEC	TSW-113-08-G-T-RA	EVKIT PART; CONNECTOR, MALE; THROUGH HOLE; 0.025IN SQ POST HEADER; RIGHT ANGLE; 39PINS; MODIFY PIN NUMBERING ARRANGEMENT
13	1	J2	Pref	01-SBH11PBPCD10STBK20P-21	SBH11-PBPC-D10-ST-BK	SULLINS ELECTRONICS CORP	SBH11-PBPC-D10- ST-BK	CONNECTOR; MALE; THROUGH HOLE; HEADER; STRAIGHT; 20PINS
14	1	J3	Pref	EH111000001242	1790283	PHOENIX CONTACT	1790283	CONNECTOR; FEMALE; THROUGH HOLE; GREEN TERMINAL BLOCK; PUSH-IN SPRING CONNECTION; RIGHT ANGLE; 2PINS
15	5	J4, PGND6, SPKN2, SPKP2, VBAT1	Pref	01-9020BUSS20AWG-00	9020 BUSS	WEICO WIRE	MAXIMPAD	EVK KIT PARTS; MAXIM PAD; WIRE; NATURAL; SOLID; WEICO WIRE; SOFT DRAWN BUS TYPE-S; 20AWG
16	1	J10	Pref	01-EJ503A-27	EJ503A	MEMORY PROTECTION DEVICES INC	EJ503A	CONNECTOR; FEMALE; THROUGH HOLE; DC JACK; 5.5MM OD; 2.1MM ID; POSITIVE TIP CONNECTOR; RIGHT ANGLE; 3PINS
17	1	JU1	Pref	01-PEC03SAAN3P-21	PEC03SAAN	SULLINS	PEC03SAAN	CONNECTOR; MALE; THROUGH HOLE; BREAKAWAY; STRAIGHT; 3PINS
18	1	L1	Pref	50-0001U-SM58	PIFE32251B-1R0MS	CYNTEC	1µH	INDUCTOR; SMT (1210); FERRITE BOBBIN CORE; 1µH; TOL = ±20%; 4.7A
19	4	MH1-MH4	Pref	02-MS440014P-02	4C25MXPS; PMSSS4400025PH; 9900; 91735A102	MCMaster-CARR	N/A	MACHINE SCREW; PHILLIPS; PAN; 4-40; 1/4IN; 18-8 STAINLESS STEEL
20	2	MTH1, MTH2	Pref	02-MS440038P-02	91772A108; PHILLIPS-PAN_4-40X3/8IN; PMSSS4400038PH; 9901	GENERIC PART	N/A	MACHINE SCREW; PHILLIPS; PAN; 4-40; 3/8IN; 18-8 STAINLESS STEEL; NOTE: SET TO OBSOLETE FOR PART NUMBER CORRECTION. KINDLY REFER TO PART NUMBER 91772A108;9901
21	4	PGND, SPKN, SPKP, VBAT	Pref	02-TS14321132BP-01	111-2223-001	EMERSON NETWORK POWER	111-2223-001	MACHINE SCREW; THUMBSCREW; BANANA; 1/4-32IN; 11/32IN; NICKEL PLATED BRASS
22	2	PGND2, PVDD	Pref	02-TPMIN5002-00	5002	KEYSTONE	N/A	TEST POINT; PIN DIA = 0.1IN; TOTAL LENGTH = 0.3IN; BOARD HOLE = 0.04IN; WHITE; PHOSPHOR BRONZE WIRE SILVER; NOT FOR COLD TEST
23	8	R5, R6, R16, R21, R23-R25, R28	Pref	80-0000R-26A	ERJ-2GE0R00	PANASONIC	0	RESISTOR; 0402; 0Ω; 0%; JUMPER; 0.10W; THICK FILM
24	5	R7-R11	Pref	80-0051R-49A	CRCW040251R0JN	VISHAY DALE	51	RESISTOR; 0402; 51Ω; 5%; 200PPM; 0.063W; THICK FILM
25	1	R27	Pref	80-0014K-18	ERJ-2RFK1402	PANASONIC	14K	RESISTOR; 0402; 14KΩ; 1%; 100PPM; 0.10W; THICK FILM

MAX98390D EV Kit Bill of Materials (continued)

ITEM	QTY	REF DES	VAR STATUS	MAXINV	MFG PART #	MANUFACTURER	VALUE	DESCRIPTION
26	1	R29	Pref	80-001K2-23	CRCW04021K20FK; 9C04021A1201LF; MCR01M2PF1201	VISHAY DALE; VISHAY DALE; ROHM SEMICONDUCTOR	1.2K	RESISTOR; 0402; 1.2K; 1%; 100PPM; 0.0625W; THICK FILM
27	1	SU1	Pref	02-JMPFS1100B-00	S1100-B;SX1100-B; STC02SYAN	KYCON;KYCON; SULLINS ELECTRONICS CORP.	SX1100-B	TEST POINT; JUMPER; STR; TOTAL LENGTH = 0.24IN; BLACK; INSULATION = PBT;PHOSPHOR BRONZE CONTACT = GOLD PLATED
28	1	U1	Pref	00-SAMPLE-01	MAX98390DEWV+	MAXIM	MAX98390DEWV+	EVKIT PART - IC; MAX98390; PACKAGE CODE: W302Q2+1; PACKAGE OUTLINE: 21-100460; WLP30
29	1	U2	Pref	10-DS7505U-U	DS7505U+	MAXIM	DS7505U+	IC; DTHM; DIGITAL THERMOMETER AND THERMOSTAT; UMAX8
30	1	PCB	—	N/A	MAX98390D_APPS_A	MAXIM	PCB	PCB:MAX98390D_APPS_A
<b>TOTAL</b>	<b>62</b>							

DO NOT PURCHASE(DNP)								
ITEM	QTY	REF DES	VAR STATUS	MAXINV	MFG PART #	MANUFACTURER	VALUE	DESCRIPTION
1	15	ADDR1, ADDR2, BCLK, DIN, DOUT, ICC, IRQ, LRCLK, LX, MCLK, SCL, SDA, VREFC, VSNSN, VSNRP	DNP	02-TPMINI5002-00	5002	KEystone	N/A	TEST POINT; PIN DIA = 0.1IN; TOTAL LENGTH = 0.3IN; BOARD HOLE = 0.04IN; WHITE; PHOSPHOR BRONZE WIRE SILVER; NOT FOR COLD TEST
2	1	C8	DNP	20-0010U-BA12	GRM155R61A106ME44; GRM155R61A106ME11; 0402ZD106MATZA; CLO5A106MPSNUNC	MURATA-MURATA; AVX;SAMSUNG	10µF	CAPACITOR; SMT (0402); CERAMIC CHIP; 10µF; 10V; TOL = 20%; TG = -55°C TO +85°C; TC=X5R
3	4	C11-C14	DNP	N/A	N/A	N/A	OPEN	PACKAGE OUTLINE 0201 NON-POLAR CAPACITOR - EVKIT
4	2	C15, C16	DNP	N/A	N/A	N/A	OPEN	PACKAGE OUTLINE 0402 NON-POLAR CAPACITOR - EVKIT
5	2	C22, C23	DNP	20-0047U-BA60	PSLB31A476M55HF; 10TPE47MAZB	NEC TOKIN; PANASONIC	47µF	CAPACITOR; SMT (3528); TANTALUM CHIP; 47µF; 10V; TOL = 20%; TG = -55°C TO +105°C
6	2	FB1, FB2	DNP	N/A	N/A	N/A	OPEN	PACKAGE OUTLINE 0402 FERRITEBEAD - EVKIT
7	1	J8	DNP	01-PEC02DAAN4P-21	PEC02DAAN	SULLINS ELECTRONIC CORP.	PEC02DAAN	CONNECTOR; MALE; THROUGH HOLE; BREAKAWAY; STRAIGHT; 4PINS
8	1	L1A	DNP	50-0001U-QWW	74406042010	WURTH ELECTRONICS INC.	1µH	INDUCTOR; SMT; SHIELDED; 1µH; 30%; 4.47A ; NOTE:PURCHASE DIRECT FROM THE MANUFACTURER
9	1	OUT	DNP	01-PEC02SAAN2P-21	PEC02SAAN	SULLINS	PEC02SAAN	CONNECTOR; MALE; THROUGH HOLE; BREAKAWAY; STRAIGHT; 2PINS
10	9	R2-R4, R13-R15, R17, R18, R20	DNP	N/A	N/A	N/A	OPEN	PACKAGE OUTLINE 0402 RESISTOR - EVKIT
11	1	R19	DNP	N/A	N/A	N/A	SHORT	PACKAGE OUTLINE 0603 RESISTOR - EVKIT
12	2	R22, R12	DNP	N/A	N/A	N/A	OPEN	PACKAGE OUTLINE 0603 RESISTOR - EVKIT
13	1	R26	DNP	80-0000R-26A	ERJ-2GE0R00	PANASONIC	0	RESISTOR; 0402; 0Ω; 0%; JUMPER; 0.10W; THICK FILM
14	1	SPKN1	DNP	02-TPMINI5001-00	5001	KEystone	N/A	TEST POINT; PIN DIA = 0.1IN; TOTAL LENGTH = 0.3IN; BOARD HOLE = 0.04IN; BLACK; PHOSPHOR BRONZE WIRE SILVER PLATE FINISH; RECOMMENDED FOR BOARD THICKNESS = 0.062IN; NOT FOR COLD TEST
15	1	SPKP1	DNP	02-TPMINI5000-00	5000	KEystone	N/A	TEST POINT; PIN DIA = 0.1IN; TOTAL LENGTH = 0.3IN; BOARD HOLE = 0.04IN; RED; PHOSPHOR BRONZE WIRE SILVER PLATE FINISH; RECOMMENDED FOR BOARD THICKNESS = 0.062IN; NOT FOR COLD TEST
<b>TOTAL</b>	<b>44</b>							

PACKOUT (These are purchased parts but not assembled on PCB and will be shipped with PCB)								
ITEM	QTY	REF DES	VAR STATUS	MAXINV	MFG PART #	MANUFACTURER	VALUE	DESCRIPTION
1	4	MH1-MH4	Pref	02-S0440012H-01	MCH_SO_F_HEX_4-40X1/2	GENERIC PART	N/A	STANDOFF; FEMALE-THREADED; HEX; 4-40; 1/2IN; ALUMINUM
<b>TOTAL</b>	<b>4</b>							

MAX98390D EV Kit Schematic Diagram

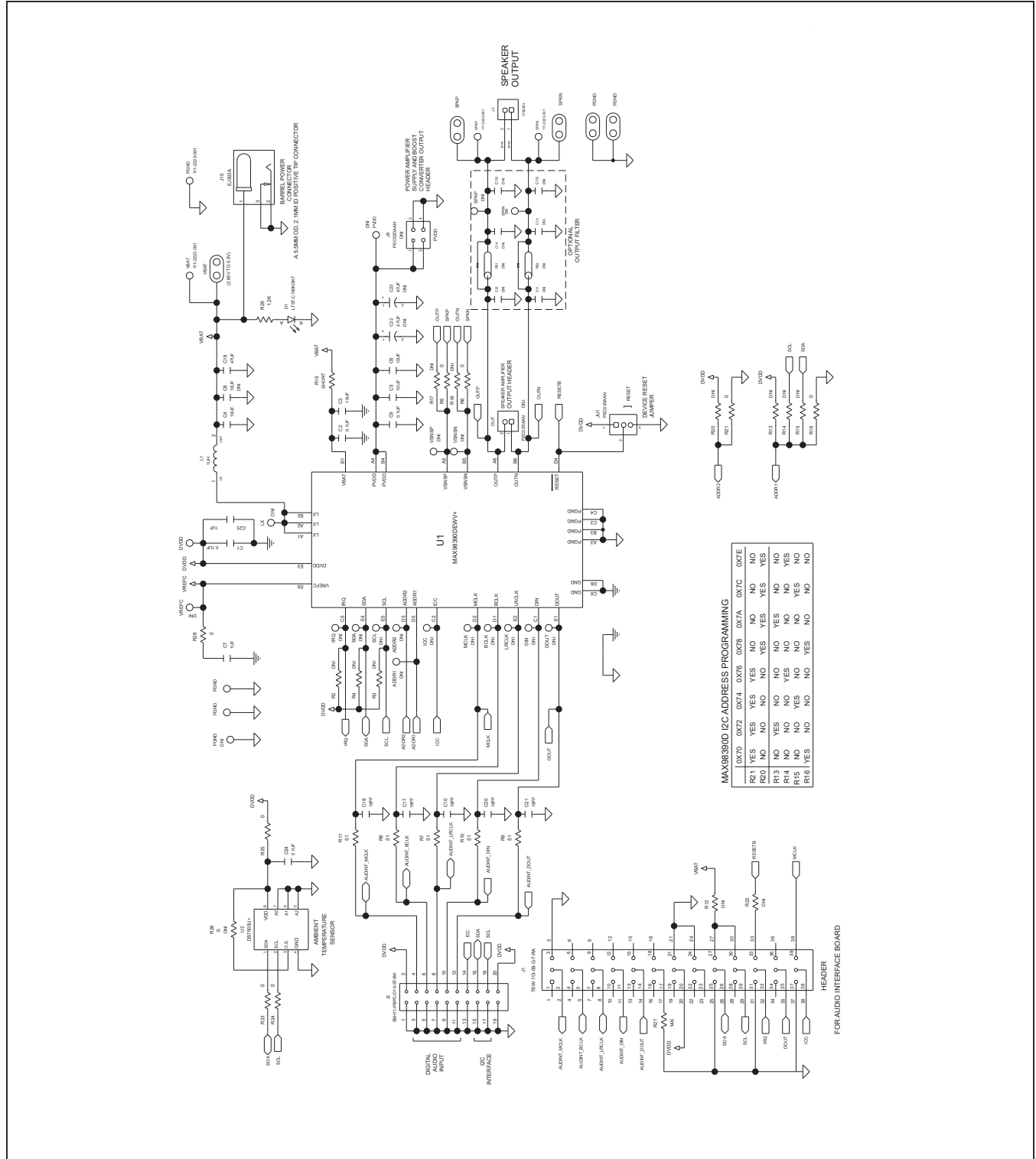

MAX98390D EV Kit PCB Layout Diagrams

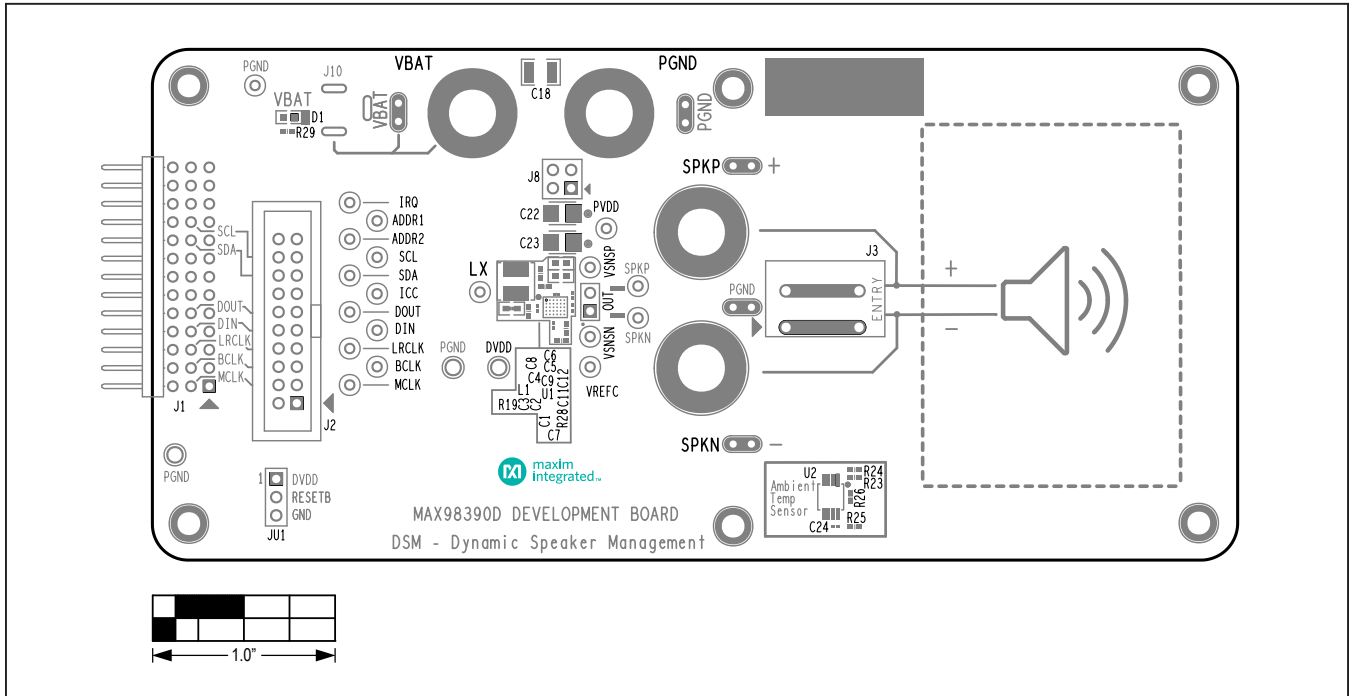

MAX98390D EV Kit Component Placement Guide—Top Silkscreen

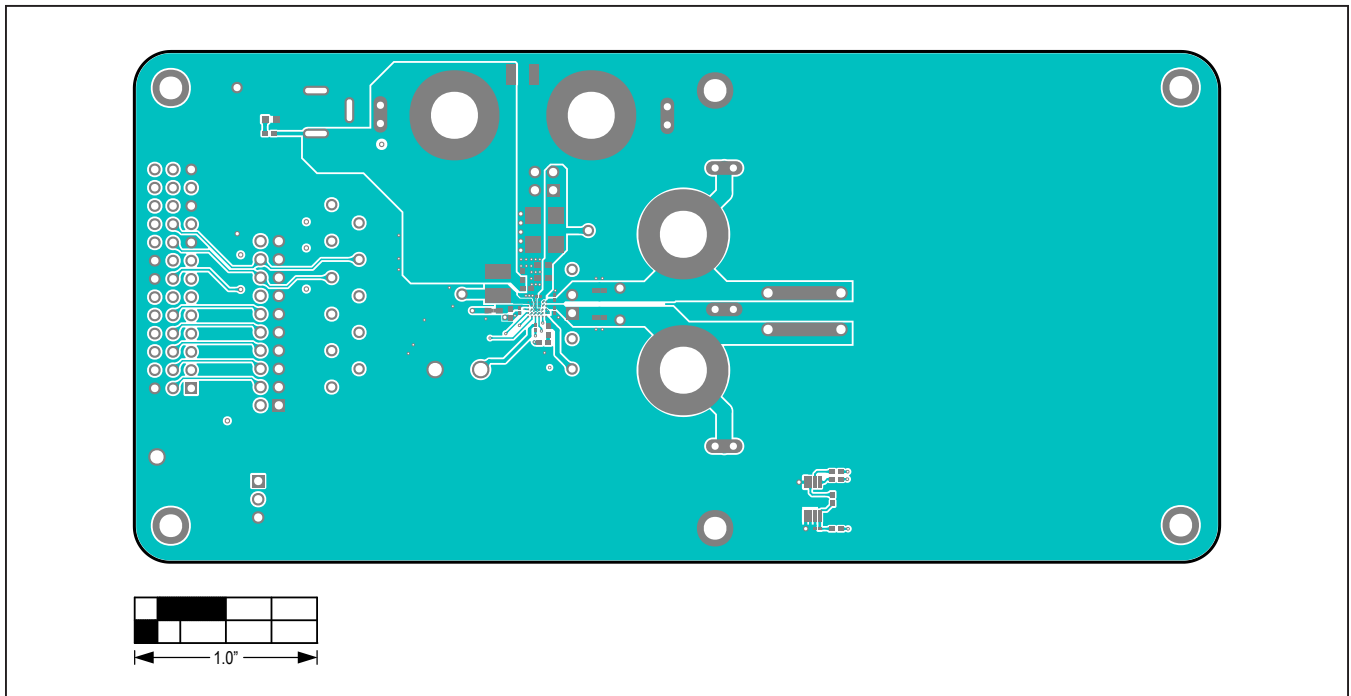

MAX98390D EV Kit PCB Layout—Top View

**MAX98390D EV Kit PCB Layout Diagrams (continued)**

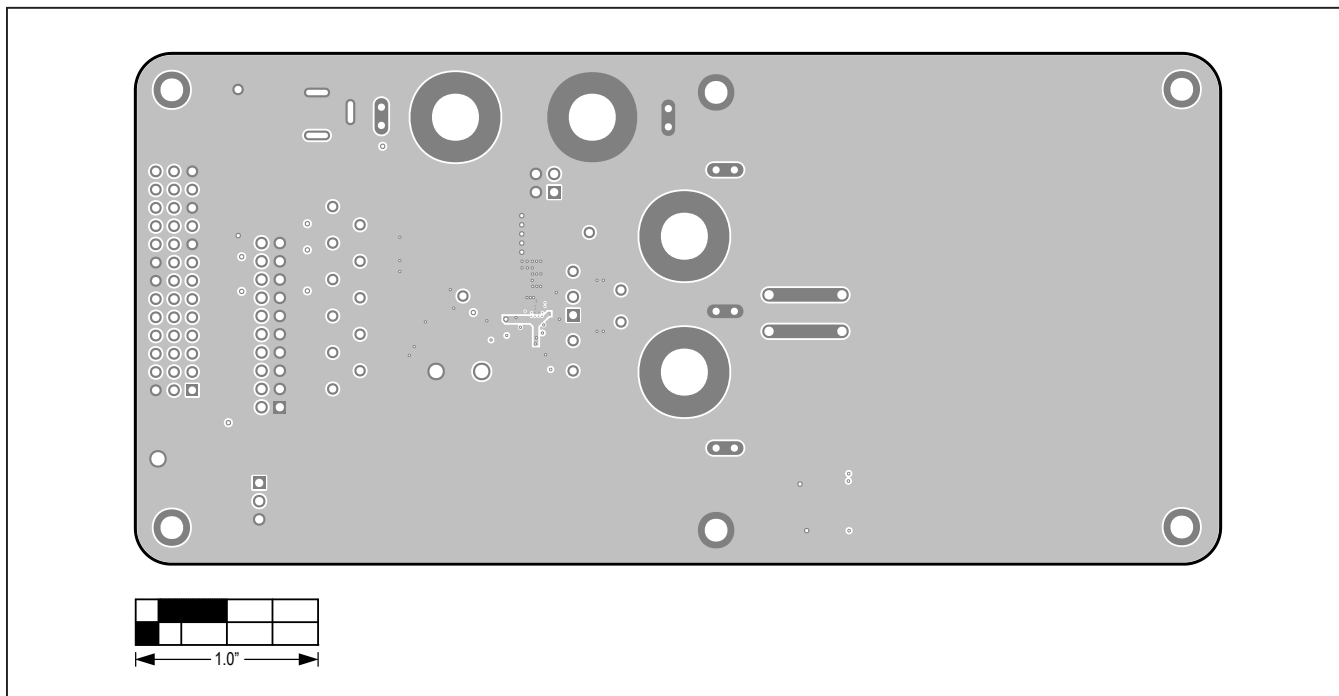

MAX98390D EV Kit PCB Layout—Inner 2

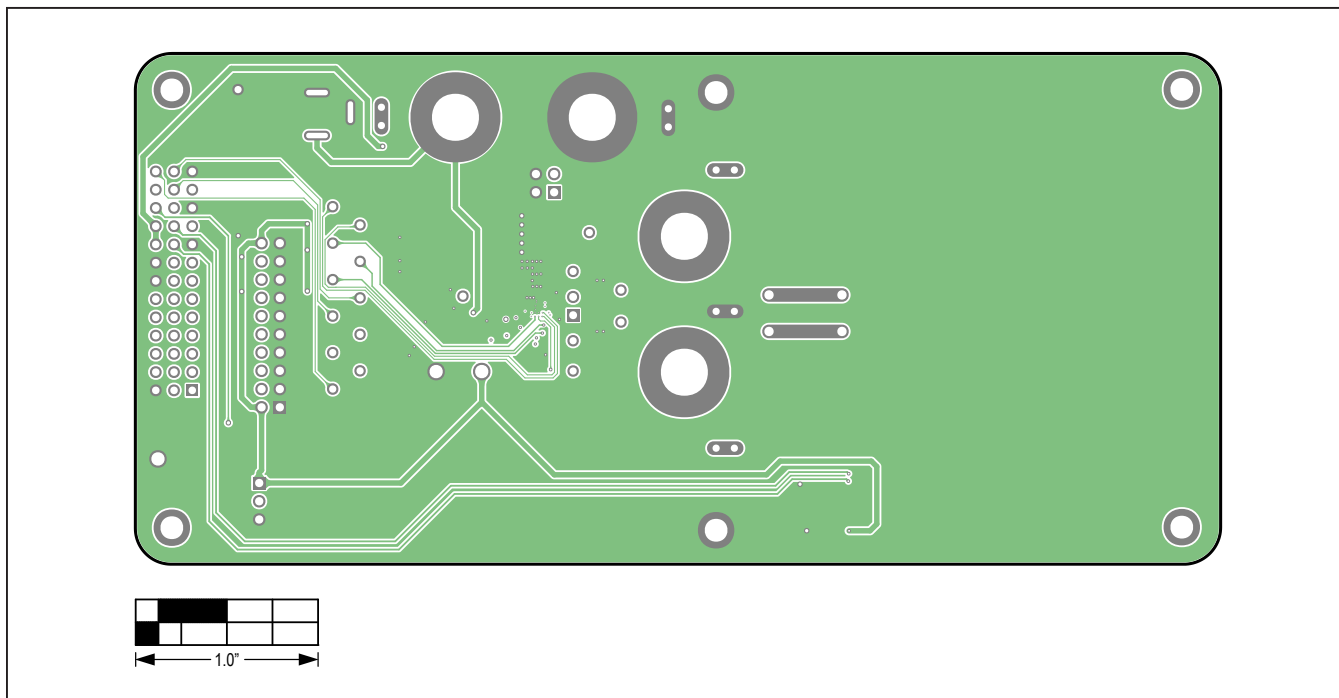

MAX98390D EV Kit PCB Layout—Inner 3

MAX98390D EV Kit PCB Layout Diagrams (continued)

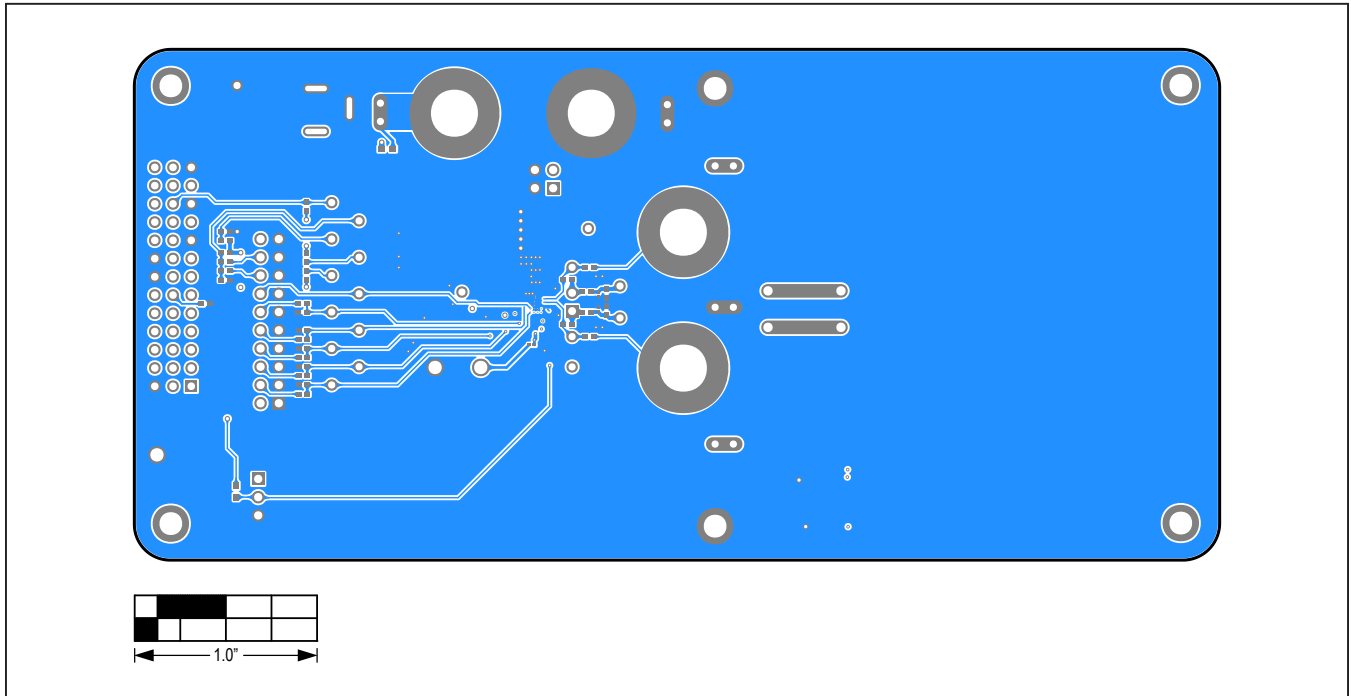

MAX98390D EV Kit PCB Layout—Bottom View

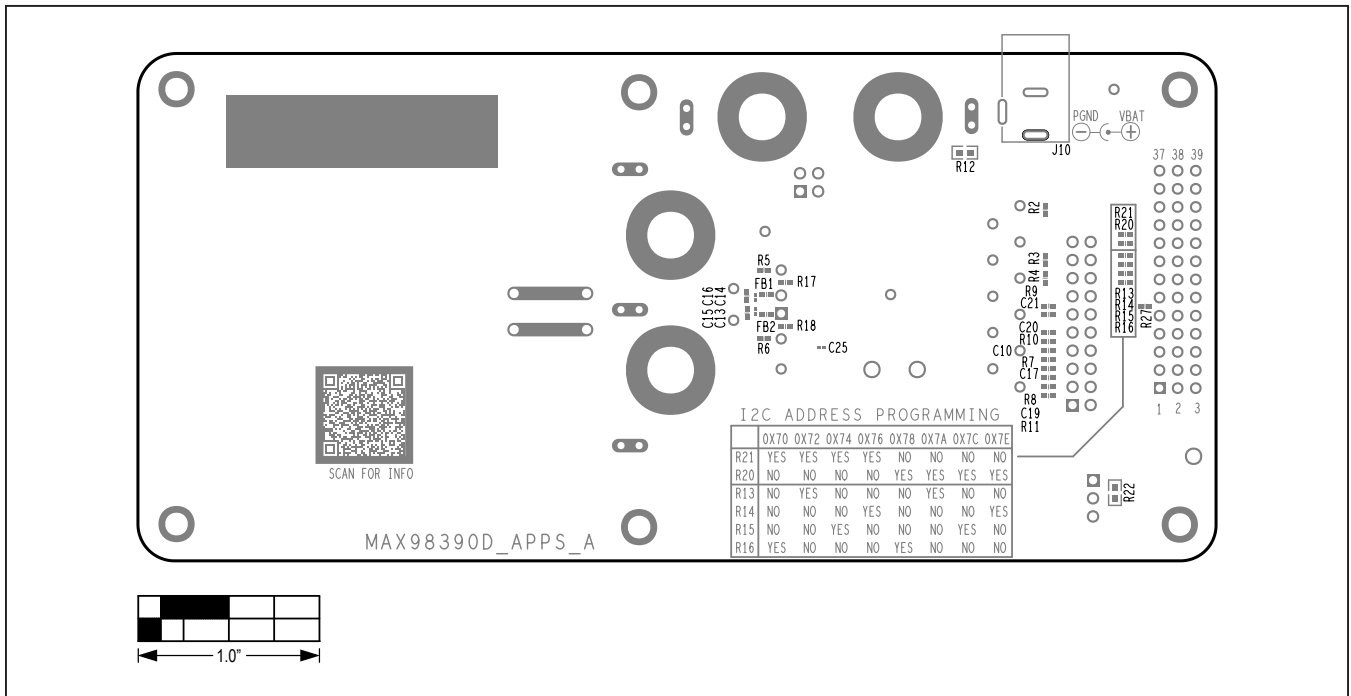

MAX98390D EV Kit Component Placement Guide—Bottom Silkscreen