

MAX98395 Evaluation System

Evaluates: MAX98395

General Description

The MAX98395 evaluation system (EV system) evaluates the MAX98395 mono Class-D audio amplifier featuring dynamic headroom tracking (DHT) and clock-and-data monitoring. The EV system consists of the IC development board (DEV board), Maxim's audio interface board III (AUDINT3), USB cable, and IC evaluation software.

It is recommended that the DEV board be evaluated with the AUDINT3 board, as an EV system. The IC supports standard I²S, left-justified, and TDM digital audio interfaces, as well as I²C for control.

The AUDINT3 board provides the USB-to-PCM and USB-to-I²C interfaces in addition to the 1.8V AVDD supply and the 1.2V DVDD and DVDDIO supplies that are needed to evaluate the DEV board. The IC DEV board requires two additional supply inputs, 3V to 5.5V (VBAT) and 3V to 14V (PVDD). [Figure 1](#) details the DEV board and the AUDINT3 board.

The MAX98395 Evaluation Software provides complete access to all hardware registers.

Features

- Complete Hardware System with Easy Setup; No Tools or Special Equipment Required
- Easy to use Graphical User Interface (GUI) Evaluation Software (Windows 7/10 Compatible)
 - Complete Access to all Hardware Registers

EV System Contents

- MAX98395 Development Board
- Audio Interface Board III
- Micro-USB Cable

[Ordering Information](#) appears at end of data sheet.

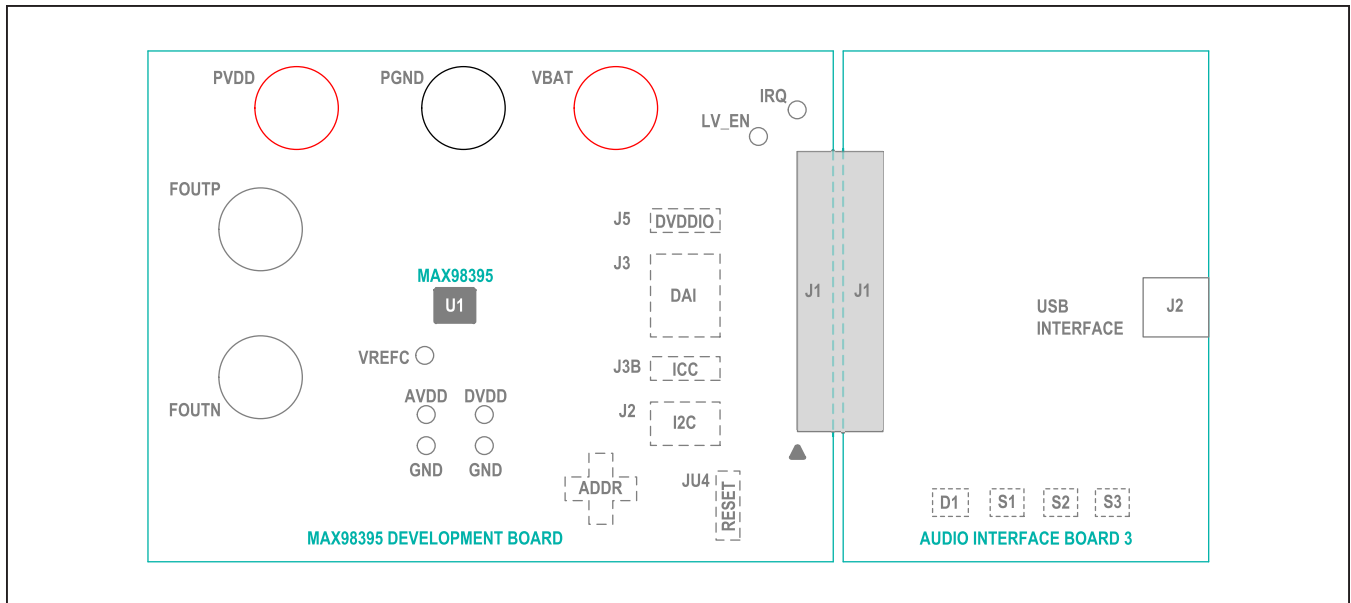

Figure 1. Simplified EV System Block Diagram

Windows is a registered trademark and registered service mark of Microsoft Corporation.

Quick Start Guide

Note: In the following sections, software-related items are identified by bolding. Text in **bold** refers to items directly from the evaluation software. Text in **bold and underlined** refers to items from the Windows operating system.

Software Installation

- 1) For the latest software, login to your MyMaxim account at MaximIntegrated.com, navigate to MAX98395 > Design Resources > MAX98395 Software. Download MAX98395EVSwSetupVxx.exe. Extract the downloaded folder to a temporary location.
- 2) Install the MAX98395 Evaluation Software by running the program installer MAX98395EVSwSetupvxx.exe. Follow the installer prompts to completion. Windows might display a message indicating that this software is from an unknown publisher. This is not an error condition and it is safe to proceed with the installation. The application icon is located at **Windows | Maxim Integrated | MAX98395 Evaluation Software**.

Required Equipment

- MAX98395 EV System
 - Audio interface board III
 - 3V to 14V DC power supply
 - 3V to 5.5V DC power supply
 - Micro-USB cable
- 4Ω to 8Ω speaker
- USB audio source (e.g., Windows Media Player® or iTunes®)
- User-supplied Windows 7 or Windows 10 PC with available USB port

Required Software

- The MAX98395 Evaluation Software application, if not already installed. See the [Software Installation](#) section.

Reference Material

- MAX98395 IC data sheet

Procedure

The MAX98395 and AUDINT3 boards are fully assembled and tested. Follow the steps below to set up the EV System for device evaluation:

AUDINT3 Board Setup:

- 1) Connect the MAX98395 DEV board (J1 connector) to the AUDINT3 board (J1 connector).

- 2) With the audio source disabled, connect the USB cable from your computer to the USB port (J2) on the AUDINT3 board. The AUDINT3 board provides the power for DVDD, sourcing 1.8V to the DEV board through the J1 connector.
- 3) The multi-color LED D1 blinks white. When the computer registers the AUDINT3 as a USB device, D1 changes to magenta and blinks slowly.

DEV Board Setup:

- 1) With all supplies unpowered, connect the 3V to 5.5V power supply across the VBAT and GND binding posts.
- 2) Connect the 3V to 14V power supply across the PVDD and GND binding posts.
- 3) Connect the micro-speaker leads across the SPKP and SPKN binding posts.
- 4) Place the shunt on jumper JU4 across pins $\overline{\text{RESET}}$ and DVDDIO.

Test:

- 1) Enable the supply voltages across each of the supply pins.
- 2) Launch the MAX98395 Evaluation Software and wait while the software connects to the EV system. See [Figure 2](#).
- 3) Once the connection is established, the status bar at the bottom of the GUI window reports USB connected, displays the MAX98395 part number, and revision ID. After the EV system is fully connected, configure the device by loading the "I2S_48kHz_IVADCs.98395" configuration file. This file can be loaded from **File, Load Register Settings, Pre-Installed Configuration Files**, then scroll down to select.
- 4) Open the Windows' **Sound** dialog and select the **Playback** tab. A **Speakers** item similar to [Figure 3](#) should be listed as an available playback device.
- 5) Verify that the **Speakers** item is set as the default device.
- 6) Adjust the audio source volume to a low level.
- 7) Enable the audio source and verify that audio is heard through the connected speaker. Adjust the audio source volume as needed.
- 8) Quick start of the Evaluation Software is now complete.

Windows Media is a registered trademark and registered service mark of Microsoft Corporation.

iTunes is a registered trademark of Apple Inc.

Detailed Description of Evaluation Software

The MAX98395 Evaluation Software is designed to be used only with the MAX98395 EV system. The software provides an intuitive graphical user interface (GUI) for programming the MAX98395 device and includes many features intended to aid evaluation.

The MAX98395 Evaluation Software's main window in [Figure 2](#) is composed of four main sections: menu bar, communication tool bar, tabbed pages, and a status bar. The menu bar provides additional features to aid evaluation, the toolbar provides basic functionality for communicating with the device, and the status bar provides information about hardware connectivity and communication status. The tabbed pages make up the bulk of the GUI and provide the controls for programming the device's hardware registers.

The **Block Diagram** tab provides access to all the device registers using dialog windows, which contain GUI controls for configuring the device. The dialog windows are opened by clicking on the blocks in the block diagram. The **Control Registers** tab provides direct access to the valid registers from 0x2000-0x21FE, as well as to the revision ID register, 0x21FF. The **Log** tab provides a log of the I2C transactions and a tool to read specific registers. The MAX98395 Evaluation Software is compatible with Windows 7 and Windows 10 and can be found on Maxim's website (MaximIntegrated.com). Refer to the MAX98395 IC data sheet for device register information.

Communication Tool Bar

The tool bar consists of seven buttons, a drop-down combo box, and a display box. These controls are always accessible, regardless of the active tabbed page. The tool bar is shown in [Figure 4](#) and [Table 1](#) provides details about each control.

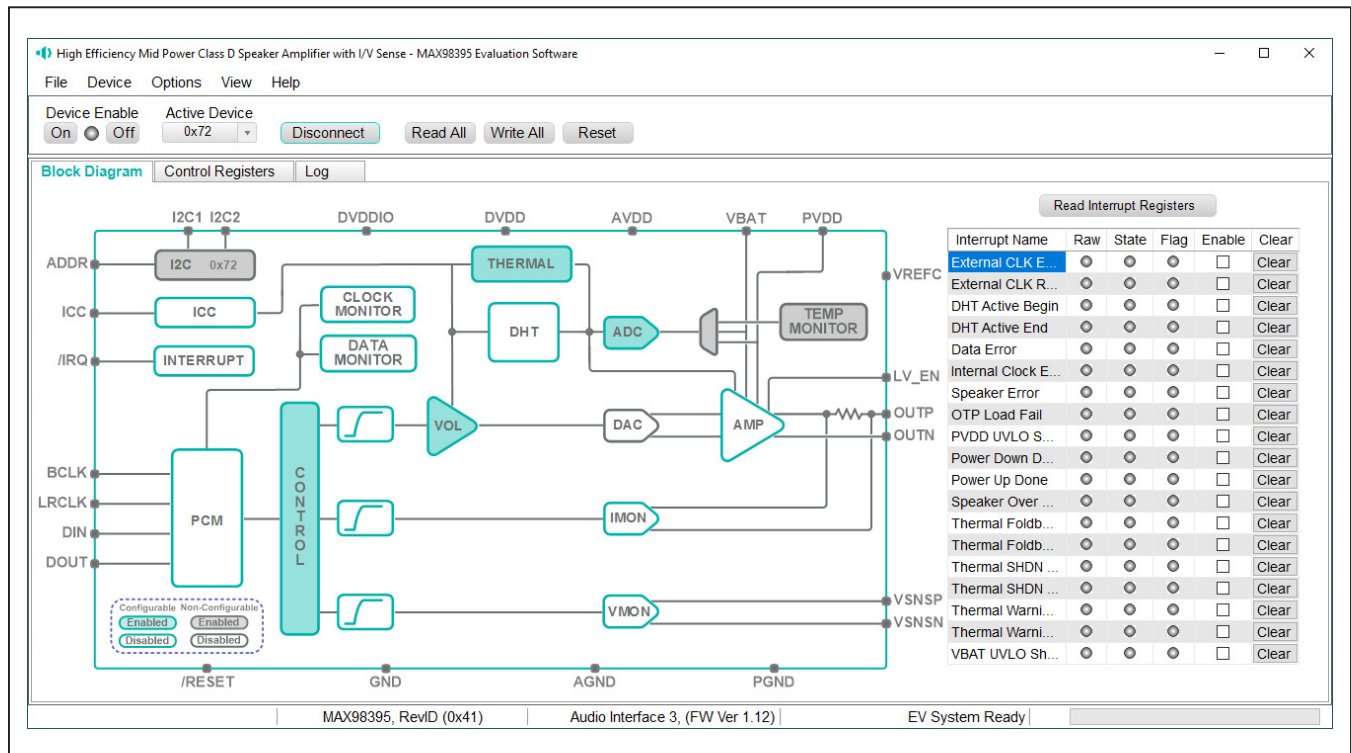

Figure 2. MAX98395 Evaluation Software

Connect Sequence

When the evaluation software starts for the first time, the program automatically connects to the EV System and attempts to connect to the USB control (USB) interface on the AUDINT3 board first. Once that connection is established, it searches for all I²C addresses associated with the MAX98395 device and populates all detected device addresses in the **Active Device** drop-down list. During this sequence, the text on the **Connect** button automatically changes from **Connect** to **Disconnect**, and the status bar is also updated to reflect the current state of the hardware connection.

Once the EV System is fully connected, the button displays **Disconnect**, and when pushed, it disconnects the software from the hardware. The software can also be disconnected from the hardware by selecting **Device | Disconnect** from the menu bar.

There are two methods to re-establish a connection with the hardware. The first is by selecting **Device | Connect** from the menu bar. This instructs the program to connect to the EV System. The second method is to manually push the **Connect** button until it displays **Disconnect**, which signifies that the EV System is fully connected.

Status Bar

The Status bar is divided into four sections. From left to right: status and alert messages, device part number and revision ID, interface name and firmware version, and evaluation system connection status.

Status Panel

The Status panel (not to be confused with the Status bar) displays the state of the **Raw**, **State**, and **Flag** interrupts. This data is read from the Raw, State, and Flag_ interrupt registers (0x2001 to 0x200D). When the image is red it indicates that the associated interrupt bit has been set.

The panel also includes checkboxes for each interrupt that is used to enable the link between an interrupt’s Flag bit and State bit. When enabled, the Flag bit is set whenever the State bit is set. To clear the State and Flag bits, click on the interrupt’s associated **Clear** button.

Note:

- 1) Each interrupt source must be enabled for the FLAG column (i.e., flag bits) to be set.
- 2) The IRQ_EN bit needs to be set for the interrupt to be output on the IRQ pin.



Figure 3. Playback Device



Figure 4. Communication Tool Bar

Table 1. Tool Bar Controls

CONTROL	FUNCTION
On	Press to set the Global Enable bit (EN). This enables the device.
Off	Press to clear the Global Enable bit (EN). This disables the device. Note: The software can communicate with a disabled device, as long as its I ² C interface remains active.
Active Device	Provides a list of detected I ² C addresses. The displayed address is the active device.
Connect/Disconnect	See the Connect Sequence section for additional details.
Connect	Detected addresses are shown in the Active Device drop-down list.
Disconnect	Press to disconnect from the USB Control interface.
Read All	Press to initiate a read of all device registers. The Control Registers and Block Diagram tabs are updated to reflect the read data.
Write All	Press to initiate a write to all device registers, using the settings shown on the Control Registers tab.
Reset	Press to reset device registers to their power-on-reset (POR) state.

Block Diagram Tab

The evaluation software uses an interactive block diagram to facilitate the programming of the MAX98395 device. The block diagram also provides a visual representation of the device’s functions and current configuration.

There are three types of blocks in the block diagram and they are identified by the cursor image. The cursor changes to a hand when over a block that opens a dialog window and changes to a solid arrow when over a block that toggles a specific device setting. If the cursor does not change when over a block, then it is an inactive block and is only provided for illustrational purposes.

The color of a diagram block changes, depending on the enabled state of the device function(s) associated with that block. An inactive block is grey, a disabled block is white, and an enabled block is teal. [Figure 5](#) shows the block diagram with the MAX98395 configured for DAI (USB audio) input and speaker output.

Dialog Windows

Dialog windows are associated with specific blocks in the block diagram and they contain the controls for configuring the registers associated with that functional block. A dialog window is opened by clicking on a dialog block. [Figure 7](#) shows the typical GUI controls that are found on a dialog window.

Control Registers Tab

The **Control Registers** tab provides two methods for configuring the device. As an example, [Figure 6](#) shows the elements of the interrupt registers.

The first configuration method involves clicking on the register’s bit labels. A greyed-out bit label indicates that the bit is currently set low. A bold bit label indicates that the bit is currently set high. Clicking on a bit toggles its state and results in a write to that register. This action also updates the value displayed in the register’s edit box, located to the right of the bit labels.

The second configuration method involves entering a hexadecimal value in the register’s edit box and then pressing the **Enter** key; the software automatically configures the device register once the **Enter** key is pressed. The state of the bit labels is then updated to reflect the value shown in the edit box.

Note: Trying to write to a read-only bit by clicking/toggling its label or entering a hex value in its edit box updates the GUI, but it does not affect the bit’s value in the device. All read-only bits are updated to reflect their current value in the device by performing a read all operation.

All changes made on this tab are reflected on the **Block Diagram** tab and on any open dialog windows.

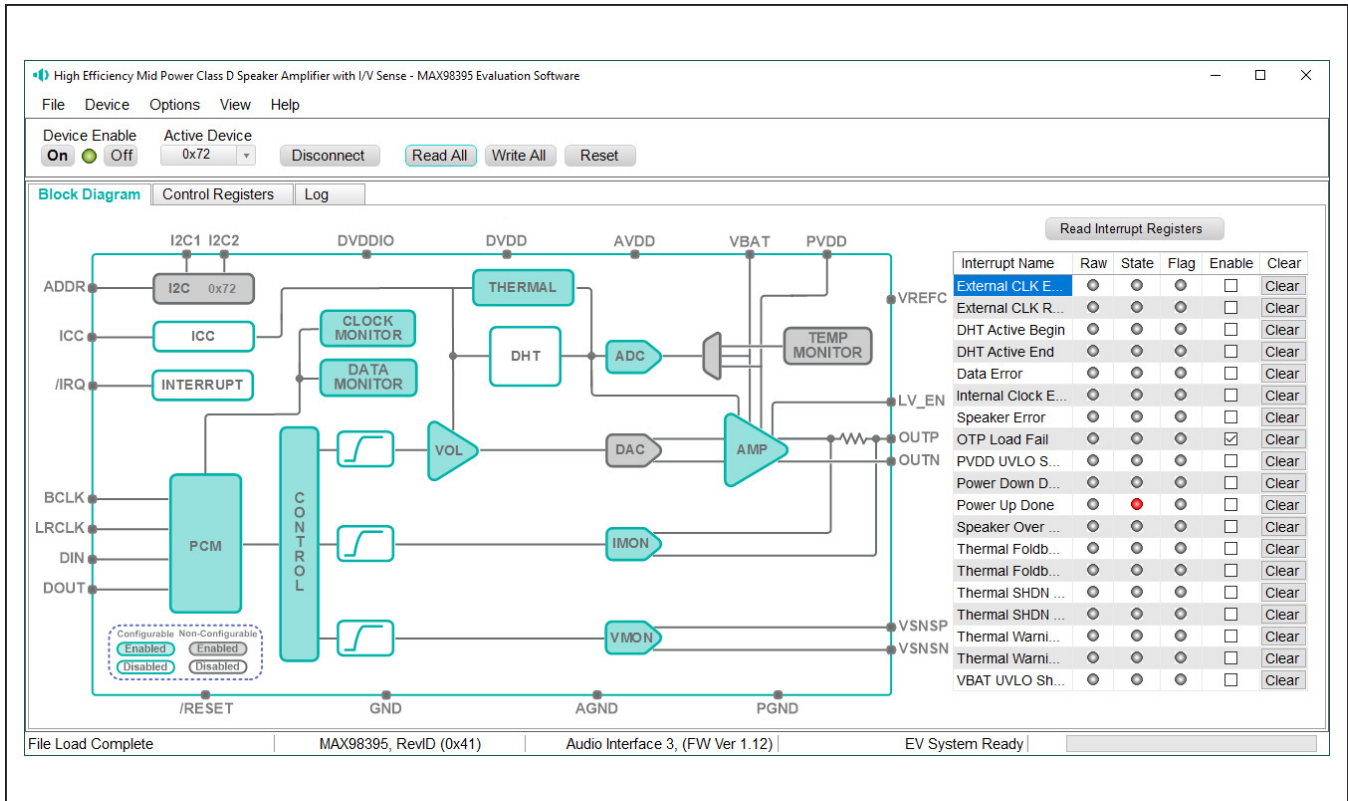

Figure 5. MAX98395 Block Diagram (USB Audio Input to Speaker Output)

Register Address	Register Name	[7]	[6]	[5]	[4]	[3]	[2]	[1]	[0]	Hex
0x2000	Software Reset								RST	0x09
0x2001	Interrupt Raw 1	THERMSHD...	THERMSHD...	THERMWAR...	THERMWAR...	THERMFB_B...	THERMFB_E...	OTP_FAIL_R...	SPK_OVC_R...	0x00
0x2002	Interrupt Raw 2			INT_SPKMO...	INT_CLK_ER...		CLK_RECO...	CLK_ERR_R...	DMON_ERR...	0x00
0x2003	Interrupt Raw 3			PWRUP_DO...	PWRDN_DO...	PVDD_UVLO...	VBAT_UVLO...	DHT_ACTIVE...	DHT_ACTIVE...	0x00
0x2006	Interrupt State 1	THERMSHD...	THERMSHD...	THERMWAR...	THERMWAR...	THERMFB_B...	THERMFB_E...	OTP_FAIL_S...	SPK_OVC_S...	0x00

Figure 6. Control Register Tab

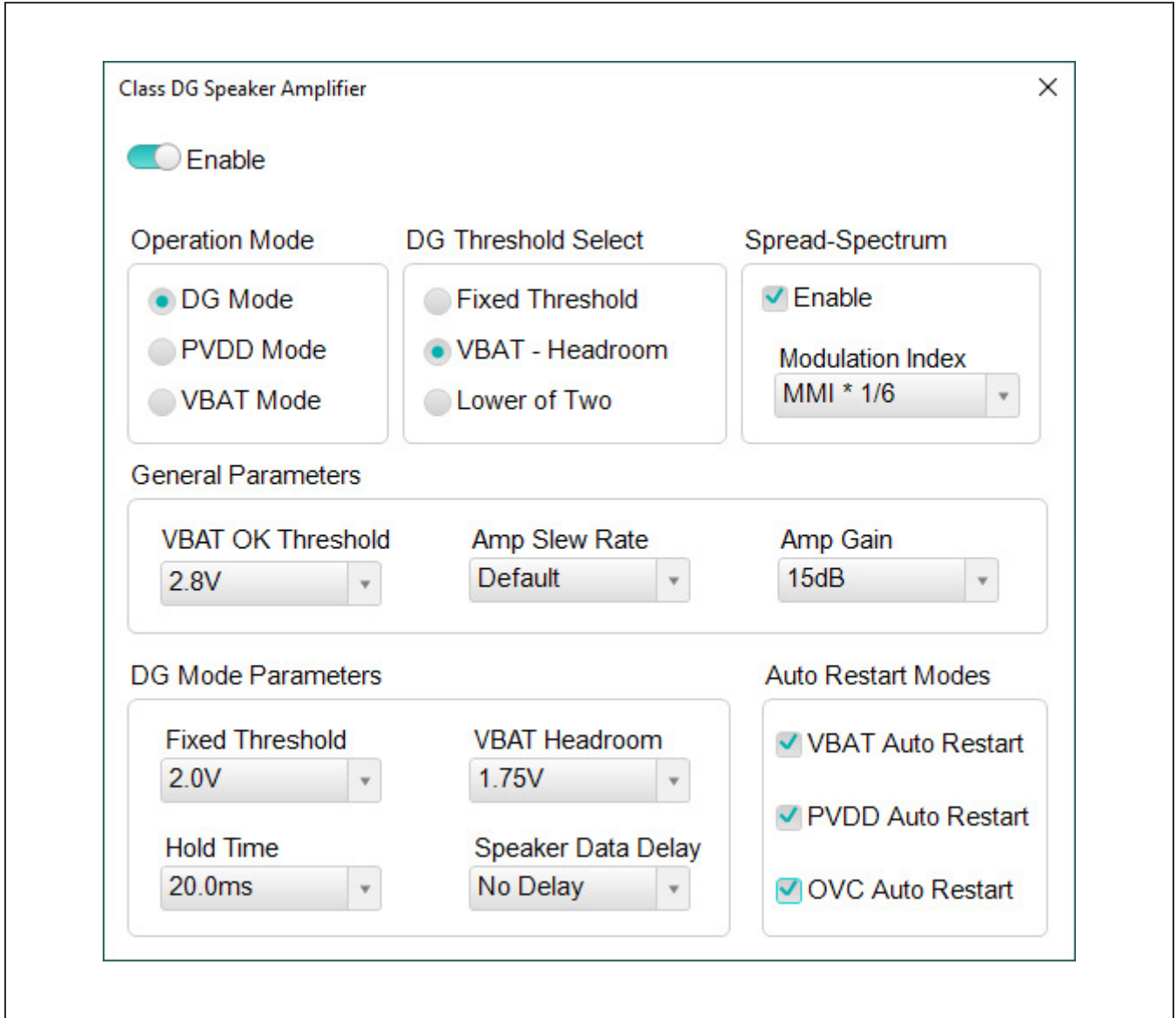

Figure 7. Typical GUI Controls

Menu Bar

All the menu bar items are described in [Table 2](#), with additional information for some menu items provided in the following sections.

File I/O

The software’s save and load features are accessed from the **File** menu. The **Save Control Register Settings** feature saves the data currently displayed on the **Control Registers** tab.

A configuration file’s main purpose is to capture the current state of the MAX98395 registers, as displayed on the **Register** tab. This feature makes it easy to program a device to a saved/known state and allows for the sharing of configuration files between users. To facilitate usage, use descriptive file names when saving the configuration files.

The save and load features are functional even when the hardware is not connected. This allows configuration files to be created and opened when the hardware is not available. Since the configuration file is automatically generated by the software, it is not meant to be manually formatted and doing so may cause file loading issues. To open a configuration file for viewing purposes only, use a plain text editor.

Select **File | Save Control Register Settings** to create a configuration file. The register address and its data are saved as tab-delimited values and the file is saved with a .98395 extension.

The software has many standard configuration files pre-installed. A file can be loaded by selecting **File | Load Register Settings | Pre-Installed Configuration Files**, and using the drop-down menu, select the file, then clicking **Load**.

Table 2. Menu Bar Items

MENU ITEM	DESCRIPTION
File	
Load Register Settings	Loads a configuration file (as saved by the Save Control Register Settings option or a factory pre-installed file).
Save Control Register Settings	Saves a configuration file containing the current device settings.
Exit	Closes the MAX98395 Evaluation software.
Device	
Connect	Runs a connection routine to connect to the evaluation system. First establishing a connection to the AUDINT3 board and then to the MAX98395 device.
Disconnect	Disconnects the PC from the EV System.
Reset	Resets all control registers to their power-on-reset (POR) states.
Read All	Performs a read from all registers and updates the GUI.
Write All	Performs a write to all writeable-registers, using the values show on the Control Registers tab and then updates the GUI.
Read Rev ID	Reads the device’s revision ID register and updates the status bar.
Options	
Interface Selection	Selects the I ² C hardware interface to either the Audio Interface or an I ² C Bridge (not supported).
Configuration Mode F4	Opens a dialog that allows multiple MAX98395 devices to be selected for configuration through the software. This feature is available only when more than one active device is detected.
Demo Mode	Puts the software in demo mode.
Help	
View Help F1	Links to technical documents.
About	Provides information about the MAX98395 Evaluation Software.

Detailed Description of Hardware

The MAX98395 EV System is designed to allow for a thorough evaluation of the MAX98395 boosted Class-D audio amplifier IC. The EV System includes the MAX98395 development board (DEV board), Maxim’s Audio Interface Board III (AUDINT3), and a Micro-USB cable.

The MAX98395 DEV board can be evaluated as a stand-alone board that is driven directly by audio test equipment, powered by multiple external supplies, and configured by an external I²C capable controller. To simplify the evaluation, the DEV board can be evaluated with the AUDINT3 board. This hardware combination provides an easy-to-use method for exercising the capabilities of the device with no additional audio equipment.

The AUDINT3 board provides on-board LDO regulators, USB-to-PCM, and USB-to-I²C interfaces. The AUDINT3 LDO regulators are used to power the MAX98395’s DVDD, DVDDIO, and AVDD supply rail through connector J1. The USB-to-PCM converter accepts a USB audio stream from a USB connected computer and converts that into an I²S data stream, allowing for USB audio playback through the MAX98395 device. The USB-to-I²C interface is the bridge that allows the evaluation software to configure, monitor, and control the I²C capable devices on the MAX98395 DEV and AUDINT3 boards. Do not use the AUDINT3 board while directly driving the DEV board’s PCM interface with external audio test equipment since the Digital Audio Interface (DAI) pins for the DEV board and AUDINT3 are connected through the J1 header.

Measuring Quiescent Current

To accurately measure the quiescent current of the MAX98395, the AUDINT3 should be disconnected from J1 and the DVDD, DVDDIO (1.2V), and the AVDD (1.8V) supplies must then be powered by external power supplies. I²C control and PCM audio can then be connected using J2 on the DEV board.

Power Supplies

The MAX98395 DEV board requires up to five external power supplies when evaluated as a stand-alone board. If 1.8V operation is desired, DVDD, DVDDIO, and AVDD pins can be shorted together by soldering 0Ω resistors to R13, R14, and R31 on the bottom layer of the DEV board.

Soldering a MAX8887EZX18+ LDO regulator in the U2 position on the bottom layer of the DEV board eliminates the need for an external 1.8V supply.

The power supplies and their ranges are listed in [Table 3](#). The external supply voltages can be connected at the respective supply test-points and/or binding posts.

When using the AUDINT3 board, the AUDINT3’s on-board LDO regulators independently power DVDD, DVDDIO, and AVDD on the DEV board. This power is routed to the DEV board through the J1 connector. See the [Digital Audio Interface](#) section.

Jumper Selection

The DEV board includes jumper JU4 to facilitate a device reset. [Table 4](#) describes the JU4 configuration options. **Note:** Before starting evaluation, ensure that the jumper is configured as needed.

Digital Audio Interface

The MAX98395 Digital Audio Interface (DAI) is routed to interface header J3 as well as the AUDINT3 connector J1. The interface headers provide easy access to the device’s PCM bus and the AUDINT3 connector allows for USB audio to be streamed onto the DEV board. See the [USB Audio Input](#) section for details on USB audio streaming and [Table 6](#) for the connector J1 pinout.

Table 3. Power Supplies

POWER SUPPLY	RANGE (V)
VBAT	3.0 to 5.5
PVDD	3.0 to 14.0
DVDD	1.14 to 1.89
DVDDIO	1.14 to 1.26 1.71 to 1.89
AVDD	1.71 to 1.89

Table 4. Jumper Configuration (JU4)

HEADER	SHUNT POSITION	DESCRIPTION
JU4	$\overline{\text{RESET}}$ to DVDDIO	Normal operation
	$\overline{\text{RESET}}$ to GND	Device is reset

DAI Header

The DAI header (J3) provides access to MAX98395’s PCM bus (BCLK, LRCLK, DIN, and DOUT). These DAI headers facilitate evaluation with audio equipment I/O. See [Table 5](#)

for the pinout of the DAI headers and [Figure 8](#) for an illustration of how the MAX98395 DAI interface is routed through the DAI headers to the AUDINT3 connector.

Table 5. DAI Header (Portion of J3)

SIGNAL	PIN	PIN	SIGNAL
GND	1	2	BCLK
GND	3	4	LRCLK
GND	5	6	DIN
GND	7	8	DOUT

Table 6. AUDINT3 Connector (J1)

SIGNAL	PIN	SIGNAL	PIN	SIGNAL	PIN
—	1	MCLK	2	GND	3
BCLK2	4	BCLK1	5	GPIO1	6
LRCLK2	7	LRCLK1	8	GPIO2	9
DAC2	10	DAC1	11	GPIO3	12
ADC2	13	ADC1	14	GPIO4	15
—	16	ID	17	3.3V	18
AVDD	19	DVDD	20	GND	21
HPVD	22	VDDIO	23	GND	24
GND	25	SDA	26	5V	27
—	28	SCL	29	5V	30
GND	31	IRQ	32	RST	33
—	34	—	35	—	36
GND	37	—	38	—	39

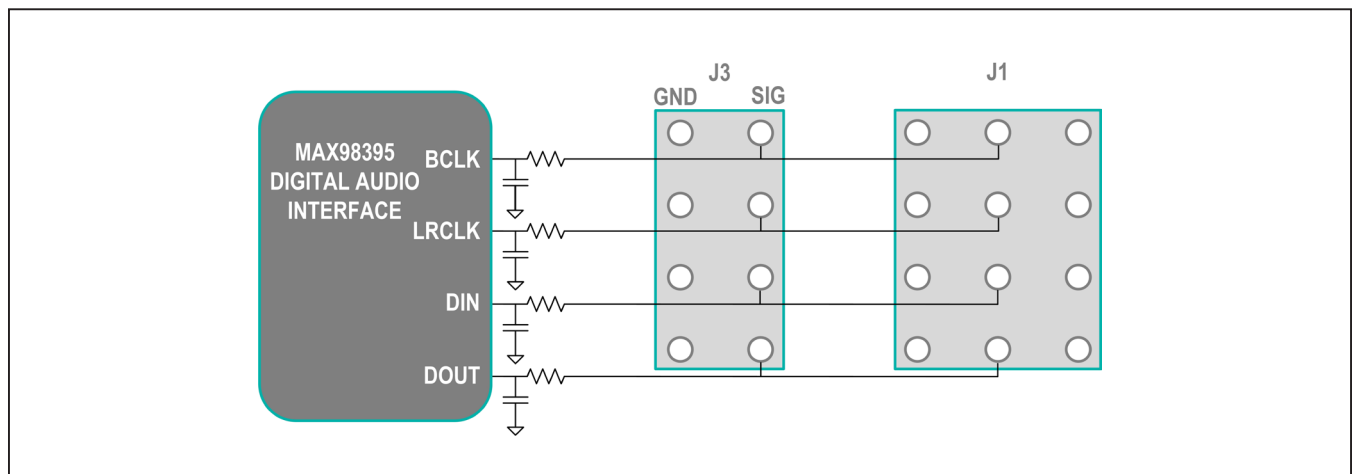

Figure 8. MAX98395 DAI Interface Headers (PCM)

Speaker Output

The MAX98395 audio output is routed to the FOUTP and FOUTN connections on the DEV board. The DEV board is, by default, assembled to allow the MAX98395 output to connect directly to a speaker load without the need for filtering.

EMI Filter

When long speaker cables are used with the MAX98395 output, a ferrite bead plus capacitor filter can be installed to prevent excessive EMI radiation. Although it is best to choose filter components based on EMI test results, the combination of 100pF capacitors (C11, C12) and ferrite beads (FB1, FB2) generally works well. Before adding the filters to the design, first remove the small PCB traces shorting FB1 and FB2 (see the [MAX98395 EV System Development Board Schematic](#) and the [MAX98395 EV System Development Board PCB Layout Diagrams](#)).

Table 7. I²C Header (J2)

SIGNAL	PIN	PIN	SIGNAL
GND	1	2	SDA
GND	3	4	SCL

Table 8. I²C Address Resistors

R6 & R7	R22 & R23	ADDR PIN	I ² C Slave ADDRESS
0Ω	OPEN	GND	0x70*
0Ω	OPEN	DVDDIO	0x72
0Ω	OPEN	SDA	0x74
0Ω	OPEN	SCL	0x76
OPEN	0Ω	GND	0x78
OPEN	0Ω	DVDD	0x7A
OPEN	0Ω	SDA	0x7C
OPEN	0Ω	SCL	0x7E

*Default position

I²C Interface

The MAX98395's I²C interface is routed to connector J1. The J1 connector is for the AUDINT3 board and connects the device's I²C interface to the I²C interface of the AUDINT3 board. This connection allows the MAX98395 evaluation software to read and write to the device. See [Table 6](#).

Header J2 allows for an external I²C controller to connect to the device's I²C bus. See [Table 7](#).

Device Address

The MAX98395 I²C device address can be configured to one of eight values: 0x70 (default), 0x72, 0x74, 0x76, 0x78, 0x7A, 0x7C, and 0x7E. The device address is set by connecting the device's ADDR1 pin to GND, SDA, SCL, or DVDDIO, and ADDR2 pin to DVDD or GND. This is accomplished by installing a 0Ω resistor in either the R6 and R7 locations or the R22 and R23 locations. For proper address programming, only one resistor is used for each ADDR pin. R6, R7, R22, and R23 are located on the bottom side of the board and are identified with silkscreen. See [Table 8](#) for all I²C slave address options.

Audio Interface Board III

Maxim’s Audio Interface board III (AUDINT3 board) facilitates the evaluation of the DEV board by providing a set of features that can be used to exercise the capabilities of the DEV board without the need for additional audio equipment. The main components of the AUDINT3 board are its LDO supply voltages, its USB-to-I²C and USB-to-PCM interfaces. The supply voltages allow the DEV board to be evaluated with a minimal amount of external supplies. The USB-to-PCM converter allows any computer to be used as an audio source for the DEV board’s digital audio PCM interface, and the USB-to-I²C interface allows for the use of the MAX98395 evaluation software, making device configuration and monitoring a lot simpler.

The MAX98395 DEV board connects to the AUDINT3 board through connector J1. The physical connections made between the DEV board and the AUDINT3 board are listed in [Table 6](#).

USB Audio Input

To utilize the USB streaming feature of the AUDINT3 board, connect the USB cables from your computer to the USB connector J2 on the AUDINT3 board and ensure that the AUDINT3 board is connected to the DEV board.

Once the hardware is ready, use the MAX98395 evaluation software to configure and enable the device for DAI audio playback.

Ordering Information

PART	TYPE
MAX98395EVSYS#	Complete Evaluation System

#Denotes a RoHS-compliant device.

MAX98395 EV System Development Board Bill of Materials

ITEM	REF_DES	DNI/DNP	QTY	MFG PART #	MANUFACTURER	VALUE	DESCRIPTION	COMMENTS
1	ADDR, ICC, RESET, VREFC	-	4	5002	KEYSTONE	N/A	TEST POINT; PIN DIA=0.1IN; TOTAL LENGTH=0.3IN; BOARD HOLE=0.04IN; WHITE; PHOSPHOR BRONZE WIRE SILVER;	
2	AVDD, DVDD, DVDDIO	-	3	5010	KEYSTONE	N/A	TEST POINT; PIN DIA=0.125IN; TOTAL LENGTH=0.445IN; BOARD HOLE=0.063IN; RED; PHOSPHOR BRONZE WIRE SIL;	
3	BCLK, DIN, DOUT, IRQ, LRCLK	-	5	5003	KEYSTONE	N/A	TEST POINT; PIN DIA=0.1IN; TOTAL LENGTH=0.3IN; BOARD HOLE=0.04IN; ORANGE; PHOSPHOR BRONZE WIRE SILVER PLATE FINISH;	
4	C4, C5, C19, C20	-	4	GRM033R60J105MEA2; C0603X5R0J105M030; CL03A105MQ3CSN	MURATA;TDK;SAMSUNG	1UF	CAPACITOR; SMT (0201); CERAMIC CHIP; 1UF; 6.3V; TOL=20%; MODEL=GRM SERIES; TG=-55 DEGC TO +85 DEGC; TC=X5R	
5	C6	-	1	EMZA350ADA221MHA0G	UNITED CHEMI-CON	220UF	CAPACITOR; SMT (CASE_HAO); ALUMINUM-ELECTROLYTIC; 220UF; 35V; TOL=20%; MODEL=MZA SERIES	
6	C7	-	1	TMK105BJ104KV; GRM155R61E104KA87	TAIYO YUDEN;MURATA	0.1UF	CAPACITOR; SMT (0402); CERAMIC CHIP; 0.1UF; 25V; TOL=10%; TG=-55 DEGC TO +85 DEGC; TC=X5R	
7	C8	-	1	CL1608X5R1E106M080AC; CL10A106MA8NRNC; GRM188R61E106MA73; ZRB18AR61E106ME01; GRT188R61E106ME13	TDK; SAMSUNG ELECTRONICS; MURATA;;MURATA	10UF	CAPACITOR; SMT (0603); CERAMIC CHIP; 10UF; 25V; TOL=20%; TG=-55 DEGC TO +85 DEGC; TC=X5R	
8	C15	-	1	C3216X5R1E476M160AC	TDK	47UF	CAPACITOR; SMT (1206); CERAMIC CHIP; 47UF; 25V; TOL=20%; MODEL=C SERIES; TG=-55 DEGC TO +85 DEGC; TC=X5R ;	
9	C22	-	1	GRM155R61A106ME44; GRM155R61A106ME11; 0402ZD106MAT2A; CL05A106MP5NUNC	MURATA;MURATA; AVX;SAMSUNG	10UF	CAPACITOR; SMT (0402); CERAMIC CHIP; 10UF; 10V; TOL=20%; TG=-55 DEGC TO +85 DEGC; TC=X5R	
10	C23	-	1	CL03A105MO3NRN	SAMSUNG ELECTRONICS	1UF	CAPACITOR; SMT (0201); CERAMIC CHIP; 1UF; 16V; TOL=20%; TG=-55 DEGC TO +85 DEGC; TC=X5R	
11	FOUTN, FOUTP, GND, PVDD, VBAT	-	5	111-2223-001	EMERSON NETWORK POWER	111-2223-001	MACHINE SCREW; THUMBSCREW; BANANA; 1/4-32IN; 11/32IN; NICKEL PLATED BRASS	
12	J1	-	1	TSW-113-08-G-T-RA	SAMTEC	TSW-113-08-G-T-RA	EVKIT PART; CONNECTOR; MALE; THROUGH HOLE; 0.025IN SQ POST HEADER; RIGHT ANGLE; 39PINS; MODIFY PIN NUMBERING ARRANGEMENT	
13	J2	-	1	PEC02DAAN	SULLINS ELECTRONIC CORP.	PEC02DAAN	CONNECTOR; MALE; THROUGH HOLE; BREAKAWAY; STRAIGHT; 4PINS	
14	J3	-	1	PEC04DAAN	SULLINS ELECTRONICS CORP.	PEC04DAAN	CONNECTOR; MALE; THROUGH HOLE; BREAKAWAY; STRAIGHT; 8PINS	
15	J3B, J5	-	2	PEC02SAAN	SULLINS	PEC02SAAN	CONNECTOR; MALE; THROUGH HOLE; BREAKAWAY; STRAIGHT; 2PINS	
16	J4, J6, X1-X4, X6	-	7	9020 BUSS	WEICO WIRE	MAXIMPAD	EVK KIT PARTS; MAXIM PAD; WIRE; NATURAL; SOLID; WEICO WIRE; SOFT DRAWN BUS TYPE-S; 20AWG	
17	JU4	-	1	PEC03SAAN	SULLINS ELECTRONICS CORP.	PEC03SAAN	EVKIT PART-CONNECTOR; MALE; THROUGH HOLE; BREAKAWAY; STRAIGHT; 3PINS; -65 DEGC TO +125 DEGC;	
18	JU6	-	1	PBC05SAAN	SULLINS ELECTRONICS CORP.	PBC05SAAN	CONNECTOR; MALE; THROUGH HOLE; BREAKAWAY; STRAIGHT; 5PINS; -65 DEGC TO +125 DEGC	
19	LV_EN	-	1	5116	KEYSTONE	N/A	TEST POINT; PIN DIA=0.1IN; TOTAL LENGTH=0.3IN; BOARD HOLE=0.04IN; GREEN; PHOSPHOR BRONZE WIRE SILVER PLATE FINISH;	
20	MTH1-MTH4	-	4	91772A108; PHILLIPS-PAN_4-40X3/8IN; PMSSS4400038PH; 9901	GENERIC PART	N/A	MACHINE SCREW; PHILLIPS; PAN; 4-40; 3/8IN; 18-8 STAINLESS STEEL	
21	MTH1-MTH4	-	4	MCH_SO_F_HEX_4-40X1/2	GENERIC PART	N/A	STANDOFF; FEMALE-THREADED; HEX; 4-40; 1/2IN; ALUMINUM	
22	R1-R10, R12, R18, R23-R25	-	15	RC0402JR-070RL; CR0402-16W-000RJT	YAGEO PHYCOMP; VENKEL LTD.	0	RESISTOR; 0402; 0 OHM; 5%; JUMPER; 0.063W; THICK FILM	
23	R11, R27	-	2	CRCW04024K70FK; MCR01M2PF4701	VISHAY DALE; ROHM SEMICONDUCTOR	4.7K	RESISTOR; 0402; 4.7K OHM; 1%; 100PPM; 0.0625W; THICK FILM	
24	R28	-	1	ERJ-2RKF1602	PANASONIC	16K	RESISTOR; 0402; 16K OHM; 1%; 100PPM; 0.1W; THICK FILM	
25	SCL, SDA	-	2	5004	KEYSTONE	N/A	TEST POINT; PIN DIA=0.1IN; TOTAL LENGTH=0.3IN; BOARD HOLE=0.04IN; YELLOW; PHOSPHOR BRONZE WIRE SILVER PLATE FINISH;	

MAX98395 EV System Development Board Bill of Materials (continued)

ITEM	REF_DES	DNI/DNP	QTY	MFG PART #	MANUFACTURER	VALUE	DESCRIPTION	COMMENTS
26	SU1, SU2	-	2	S1100-B;SX1100-B; STC02SYAN	KYCON;KYCON; SULLINS ELECTRONICS CORP.	SX1100-B	TEST POINT; JUMPER; STR; TOTAL LENGTH=0.24IN; BLACK; INSULATION=PBT;PHOSPHOR BRONZE CONTACT=GOLD PLATED	
27	TP1-TP4	-	4	5011	KEystone	N/A	TEST POINT; PIN DIA=0.125IN; TOTAL LENGTH=0.445IN; BOARD HOLE=0.063IN; BLACK; PHOSPHOR BRONZE WIRE SILVER PLATE FINISH;	GND
28	TP5, TP6	-	2	5001	KEystone	N/A	TEST POINT; PIN DIA=0.1IN; TOTAL LENGTH=0.3IN; BOARD HOLE=0.04IN; BLACK; PHOSPHOR BRONZE WIRE SILVER PLATE FINISH;	DNI
29	U1	-	1	MAX98395ENI+	MAXIM	MAX98395ENI+	EVKIT PART - IC; MAX98395ENI+; LOW QUIESCENT POWER DIGITAL INPUT AMPLIFIER WITH DHT AND I/V SENSE; PACKAGE OUTLINE DRAWING: 21-100333; PACKAGE CODE: N281B2+1; BGA28	
30	PCB	-	1	MAX98395_DEV_APPS_A	MAXIM	PCB	PCB:MAX98395_DEV_APPS_A	-
31	C1-C3, C9-C12, C14, C17, C18, C21	DNP	0	N/A	N/A	OPEN	CAPACITOR; 0402 PACKAGE; GENERIC	
32	C13	DNP	0	N/A	N/A	OPEN	PACKAGE OUTLINE 0201 NON-POLAR CAPACITOR	
33	C16	DNP	0	C3216X5R1E476M160AC	TDK	47UF	CAPACITOR; SMT (1206); CERAMIC CHIP; 47UF; 25V; TOL=20%; MODEL=C SERIES; TG=-55 DEGC TO +85 DEGC; TC=X5R ;	
34	C24, C25	DNP	0	N/A	N/A	OPEN	PACKAGE OUTLINE 1206 NON-POLAR CAPACITOR	
35	C26	DNP	0	C1005X5R1E225K050	TDK	2.2UF	CAPACITOR; SMT (0402); CERAMIC CHIP; 2.2UF; 25V; TOL=10%; TG=-55 DEGC TO +85 DEGC; TC=X5R	DNI
36	C27	DNP	0	NMC0402X7R103K16TRP; GRM155R71C103KA01; CC0402KRX7R7BB103; C0402C103K4RACAUTO	NIC COMPONENTS CORP.; MURATA;YAGEO; KEMET	0.01UF	CAPACITOR; SMT (0402); CERAMIC CHIP; 0.01UF; 16V; TOL=10%; MODEL=; TG=-55 DEGC TO +125 DEGC; TC=X7R	DNI
37	FB1, FB2	DNP	0	N/A	N/A	N/A	INDUCTOR; 0603 PACKAGE; FERRITE-BEAD; GENERIC	
38	OUTN, OUTP	DNP	0	5116	KEystone	N/A	TEST POINT; PIN DIA=0.1IN; TOTAL LENGTH=0.3IN; BOARD HOLE=0.04IN; GREEN; PHOSPHOR BRONZE WIRE SILVER PLATE FINISH;	
39	OUTNSNS, OUTPSNS	DNP	0	5002	KEystone	N/A	TEST POINT; PIN DIA=0.1IN; TOTAL LENGTH=0.3IN; BOARD HOLE=0.04IN; WHITE; PHOSPHOR BRONZE WIRE SILVER;	DNI
40	R15-R17, R19, R20	DNP	0	N/A	N/A	OPEN	RESISTOR; 0402 PACKAGE; GENERIC	
41	R26	DNP	0	N/A	N/A	OPEN	PACKAGE OUTLINE 0201 RESISTOR	
42	R29, R30	DNP	0	RC0402JR-070RL; CR0402-16W-000RJT	YAGEO PHYCOMP; VENKEL LTD.	0	RESISTOR; 0402; 0 OHM; 5%; JUMPER; 0.063W; THICK FILM	DNI
43	U2	DNP	0	MAX8887EZK18+	MAXIM	MAX8887EZK18+	IC; VREG; LOW-DROPOUT; 0.3A LINEAR REGULATOR; SOT23-5	DNI
44	R13, R14, R21, R22, R31	DNP	0	N/A	N/A	OPEN	RESISTOR; 0402; OPEN; FORMFACTOR	
TOTAL			80					

NOTE: DNI--> DO NOT INSTALL(PACKOUT); DNP--> DO NOT PROCURE

MAX98395 EV System Development Board Schematic

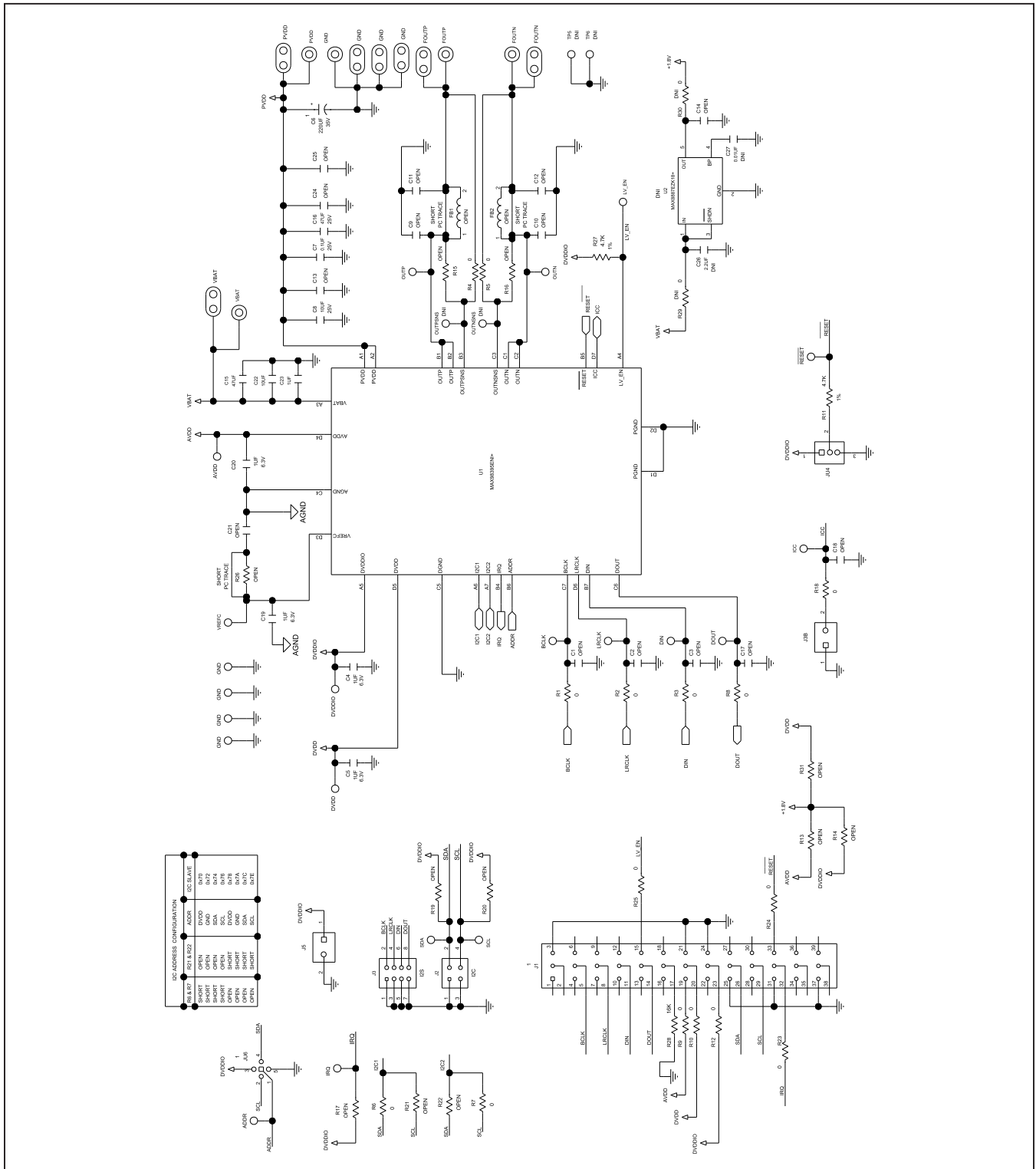

MAX98395 EV System Development Board PCB Layout Diagrams

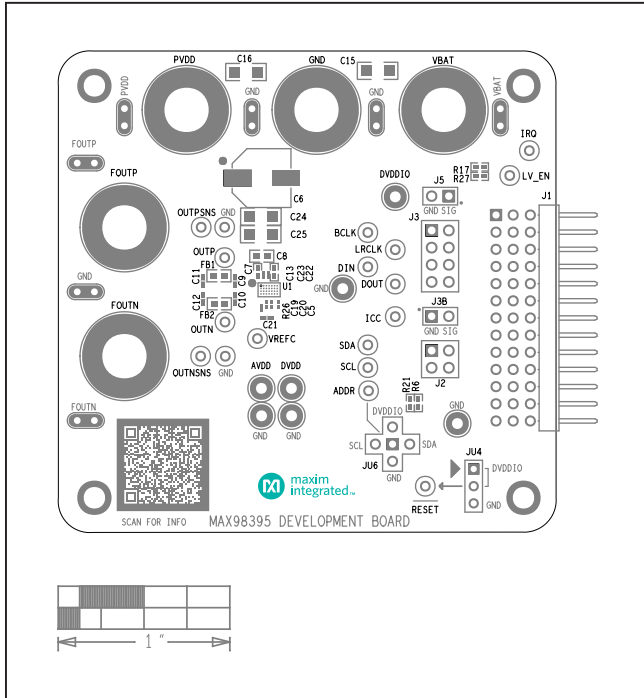

MAX98395 EV System Component Placement Guide—Top Silkscreen

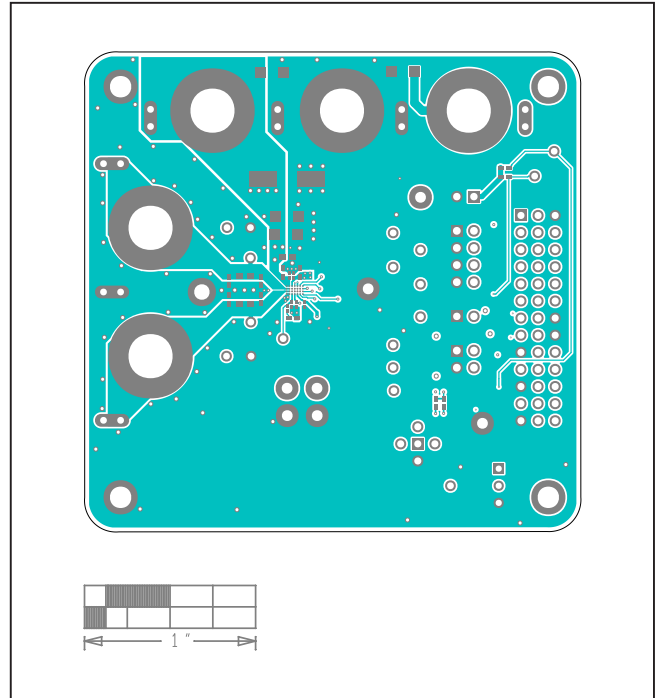

MAX98395 EV System PCB Layout—Top Layer

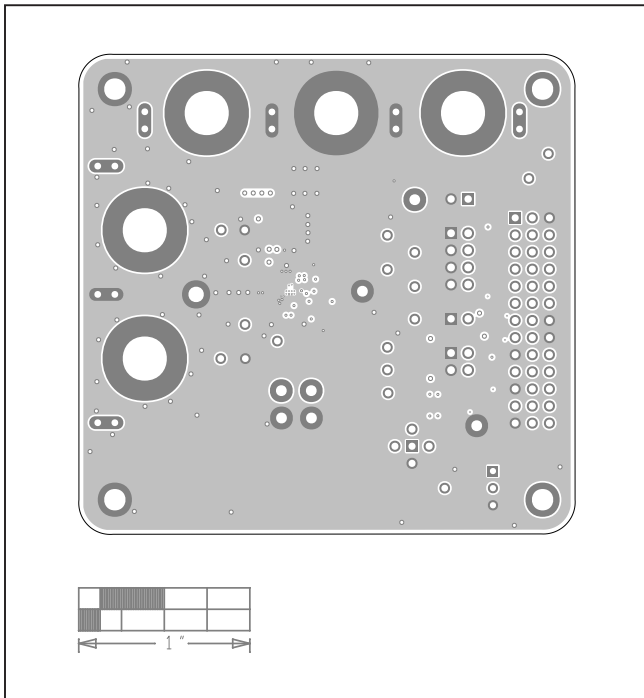

MAX98395 EV System PCB Layout—GND L2

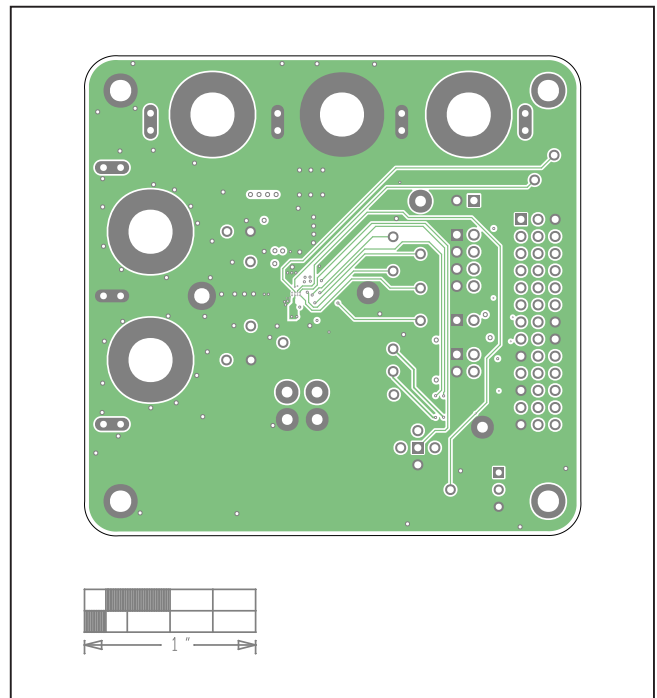

MAX98395 EV System PCB Layout—Signal GND L3

MAX98395 EV System Development Board PCB Layout Diagrams (continued)

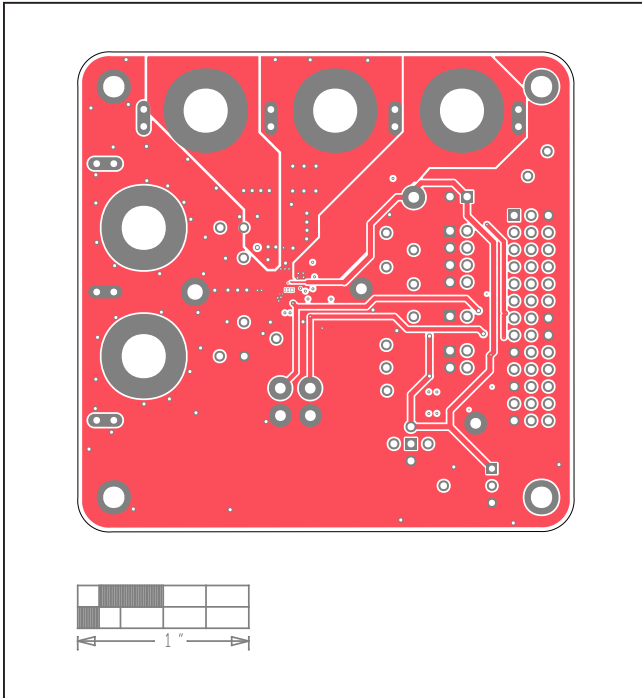

MAX98395 EV System PCB Layout—Power L4

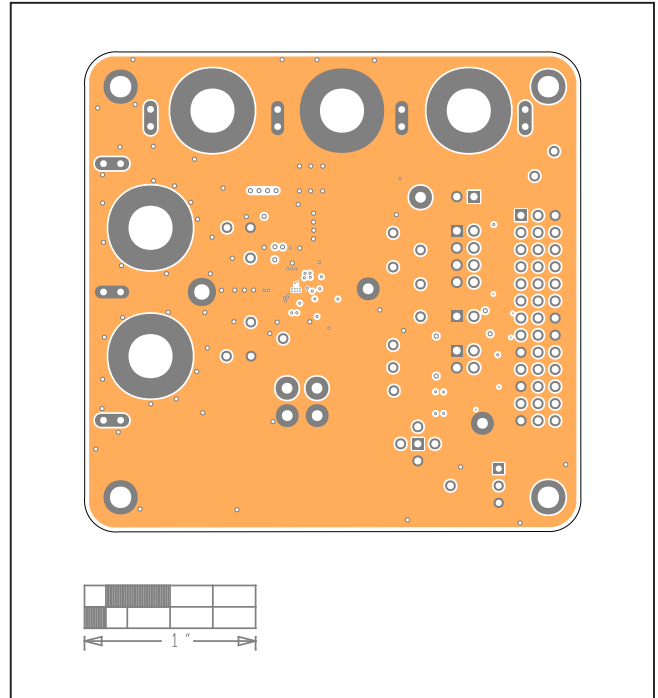

MAX98395 EV System PCB Layout—GND L5

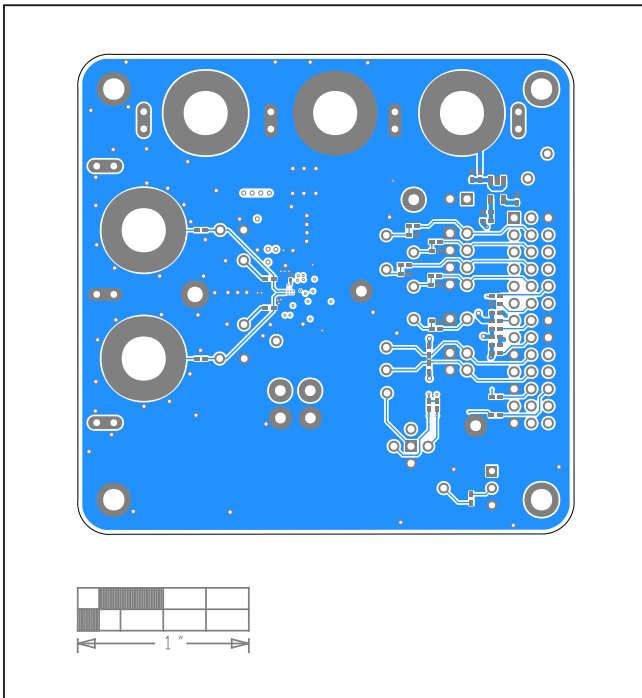

MAX98395 EV System PCB Layout—Bottom View

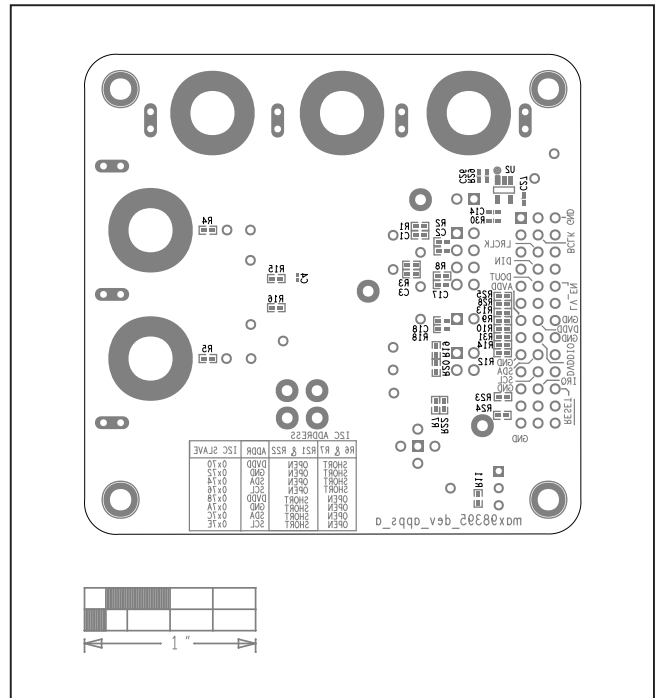

MAX98395 EV System Component Placement Guide—Bottom Silkscreen