



Boosted 2.2W Class D Amplifier with Automatic Level Control

MAX98502

General Description

The MAX98502 is a high-efficiency, Class D audio amplifier that features an integrated boost converter to deliver a constant output power over a wide range of battery supply voltages.

The boost converter operates at 2MHz, requiring only a small (2.2µH) external inductor and capacitor.

The automatic level control has a battery tracking function that reduces the output swing as the supply voltage drops, preventing collapse of battery voltage.

The amplifier has differential inputs and an internal fully differential design. The MAX98502 also features three gain settings (6dB, 15.5dB, and 20dB) that are selectable with a logic input.

The MAX98502 is available in a small, 0.5mm pitch 16-bump WLP package (2.1mm x 2.1mm). It is specified over the extended -40°C to +85°C temperature range.

Applications

- Cell Phones
- Smartphones
- GPS Devices
- Mobile Internet Devices
- Active Speaker Accessories

Features

- ◆ Boosted Class D Output
- ◆ Integrated Automatic Level Control
- ◆ Output Power
 - 2.2W into 8Ω, 10% THD+N
 - 1.7W into 8Ω, 1% THD+N
 - 4.1W into 4Ω, 10% THD+N
 - 3.4W into 4Ω, 1% THD+N
- ◆ Wide 2.5V to 5.5V Supply Voltage Range
- ◆ Undervoltage Lockout Protection
- ◆ High Total Efficiency of 87%
- ◆ High Step-Up Switching Frequency (2MHz)
- ◆ Active Emission Limiting for Low EMI

Ordering Information

PART	TEMP RANGE	PIN-PACKAGE
MAX98502EWE+	-40°C to +85°C	16 WLP

+Denotes a lead(Pb)-free/RoHS-compliant package.

Typical Application Circuit appears at end of data sheet.

Simplified Block Diagram

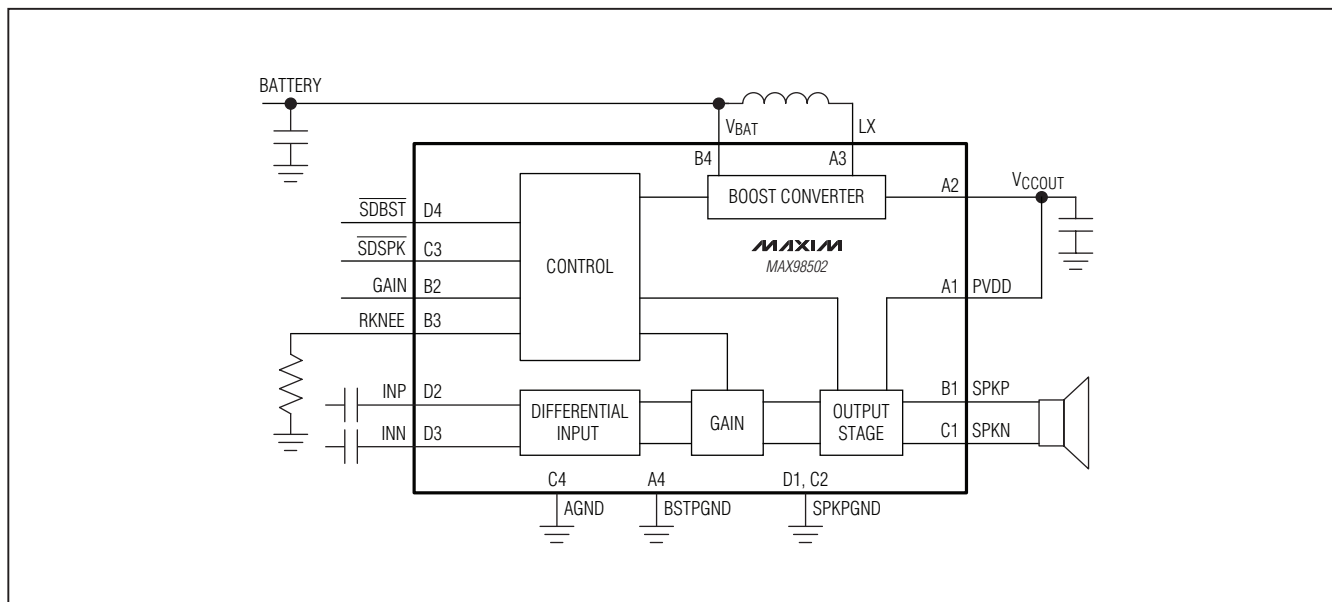

Boosted 2.2W Class D Amplifier with Automatic Level Control

ABSOLUTE MAXIMUM RATINGS

V _{BAT} to AGND	-0.3V to +6V	Duration of SPK_ Short Circuit to PVDD or SPKPGND	Continuous
V _{CCOUT} to BSTPGND, AGND	-0.3V to +6V	Duration of Short Circuit Between SPKP and SPKN	Continuous
PVDD to SPKPGND	-0.3V to +6V	Continuous Power Dissipation, Multilayer Board (T _A = +70°C)	1.33W
BSTPGND, SPKPGND to AGND	-0.3V to +0.3V	WLP (derate 20.4mW/°C above +70°C)	+150°C
GAIN to AGND	-0.3V to (V _{BAT} + 0.3V)	Junction Temperature	+150°C
SDBST, SDSPK to AGND	-0.3V to +6V	Operating Temperature Range	-40°C to +85°C
All Other Pins (excluding LX) to AGND	-0.3V to +6V	Storage Temperature Range	-65°C to +150°C
Current Into/Out of LX, V _{CCOUT} , BSTPGND	±3.9A	Soldering Temperature (reflow)	+260°C
Continuous Current Into/Out of SPK_, PVDD, SPKPGND	±800mA		
Continuous Input Current (all other pins)	±20mA		
Duration of Short Circuit Between V _{CCOUT} and BSTPGND	Continuous		

PACKAGE THERMAL CHARACTERISTICS (Note 1)

WLP

Junction-to-Ambient Thermal Resistance (θ_{JA}) 49°C/W

Note 1: Package thermal resistances were obtained using the method described in JEDEC specification JESD51-7, using a four-layer board. For detailed information on package thermal considerations, refer to www.maxim-ic.com/thermal-tutorial.

Stresses beyond those listed under "Absolute Maximum Ratings" may cause permanent damage to the device. These are stress ratings only, and functional operation of the device at these or any other conditions beyond those indicated in the operational sections of the specifications is not implied. Exposure to absolute maximum rating conditions for extended periods may affect device reliability.

ELECTRICAL CHARACTERISTICS

(V_{BAT} = 3.6V, R_L = ∞ between SPKP and SPKN, A_v = +6dB, C_{IN} = 1μF, 20Hz to 22kHz AC measurement bandwidth, T_A = T_{MIN} to T_{MAX}, unless otherwise noted. Typical values are at T_A = +25°C.) (Note 2)

PARAMETER	SYMBOL	CONDITIONS	MIN	TYP	MAX	UNITS
Power-Supply Rejection Ratio (Note 3)	PSRR	T _A = +25°C, V _{BAT} = 2.5V to 5.5V		95		dB
Quiescent Current	I _{VBAT}	T _A = +25°C, $\overline{SDSPK} = \overline{SDBST} = V_{BAT}$		3.7		mA
		T _A = +25°C, $\overline{VSDSPK} = 0V$, $\overline{SDBST} = V_{BAT}$		0.1	0.15	
	I _{PVDD}	T _A = +25°C, PVDD = 5.55V, $\overline{SDSPK} = \overline{SDBST} = V_{BAT}$		1.7	2.7	
Combined Efficiency	η	P _{OUT} = 1.7W, f = 1kHz, Z _{SPK} = 8Ω + 68μH		87		%
Shutdown Current	I _{SHDN}	$\overline{VSDSPK} = \overline{VSDBST} = 0V$, T _A = +25°C		0.04	1.5	μA
Turn-On Time	t _{ON}	Time from power-on to full operation		10	12	ms
BOOST CONVERTER						
Battery Supply Voltage Range	V _{BAT}		2.5		5.5	V
Soft-Start Interval	t _{ON}			5.6		ms
Undervoltage Lockout	UVLO	V _{BAT} falling	2.1	2.2	2.3	V
Boost Converter Output Voltage	V _{VCCOUT}	I _{LOAD} = 0mA	5.45	5.5	5.65	V
Output Current Limit	I _{MAX}	V _{BAT} ≥ 3.6V	1.5			A
Input Current Limit	I _{LIMIT}	Startup, V _{CCOUT} = 0V		0.3	0.5	A
nMOS Current Limit	I _{LX,MAX}			3.3		A
pMOS Turn-Off Current Limit				10		mA

Boosted 2.2W Class D Amplifier with Automatic Level Control

MAX98502

ELECTRICAL CHARACTERISTICS (continued)

(V_{BAT} = 3.6V, R_L = ∞ between SPKP and SPKN, A_v = +6dB, C_{IN} = 1μF, 20Hz to 22kHz AC measurement bandwidth, T_A = T_{MIN} to T_{MAX}, unless otherwise noted. Typical values are at T_A = +25°C.) (Note 2)

PARAMETER	SYMBOL	CONDITIONS		MIN	TYP	MAX	UNITS	
Switching Frequency	f _S			1.8	2.0	2.2	MHz	
Efficiency	η	0.1A ≤ I _{OUT} ≤ 0.75A		93			%	
Startup Short-Circuit Time		Converter latch off		50			ms	
Thermal Shutdown				165			°C	
LX Leakage Current		V _{LX} = 0V or 5.5V, V _{CCOUT} = 5.5V	T _A = +25°C	-1.0	+0.1	+1.0	μA	
			-40°C ≤ T _A ≤ +85°C	0.1				
SPEAKER AMPLIFIER								
Output Offset Voltage	V _{OS}	T _A = +25°C		1			3	mV
Click-and-Pop Level	K _{CP}	Peak voltage, T _A = +25°C, A-weighted, 32 samples per second, Z _{SPK} = 8Ω + 68μH, (Notes 3, 4)	Into shutdown	-56			dBV	
			Out of shutdown	-56				
Output Power (Note 5)	P _{OUT}	Z _{SPK} = 4Ω + 33μH	THD+N ≤ 1%	3.4			W	
			THD+N ≤ 10%	4.1				
		Z _{SPK} = 8Ω + 68μH	THD+N ≤ 1%	1.7				
			THD+N ≤ 10%	2.2				
Total Harmonic Distortion Plus Noise	THD+N	f = 1kHz, P _{OUT} = 1.7W, T _A = +25°C, Z _{SPK} = 4Ω + 33μH		0.05			%	
		f = 1kHz, P _{OUT} = 850mW, T _A = +25°C, Z _{SPK} = 8Ω + 33μH		0.04				
Output Switching Frequency				300			kHz	
Gain	A _v	GAIN = AGND		5.5	6	6.5	dB	
		GAIN = unconnected		15	15.5	16		
		GAIN = V _{BAT}		19.5	20	20.5		
Output Current Limit				2			A	
Efficiency	η	P _{OUT} = 1.5W, f = 1kHz, Z _{SPK} = 8Ω + 68μH		92			%	
		P _{OUT} = 1.5W, f = 1kHz, Z _{SPK} = 4Ω + 33μH		87				
Output Noise		A-weighted		43			μVRMS	
Input Resistance	R _{IN}	S _{DBST} = S _{DSPK} = V _{BAT}	A _v = 6dB (GAIN = AGND)	36	54	72	kΩ	
			A _v = 15.5dB (GAIN = unconnected)	12	18	26		
			A _v = 20dB (GAIN = V _{BAT})	6.5	11	16		
		V _{SDBST} = V _{SDSPK} = 0V	All gain settings			110		
Common-Mode Rejection Ratio	CMRR	f = 1kHz		60			dB	
Bias Voltage	V _{BIAS}			1.3	1.4	1.5	V	

Boosted 2.2W Class D Amplifier with Automatic Level Control

ELECTRICAL CHARACTERISTICS (continued)

($V_{BAT} = 3.6V$, $R_L = \infty$ between SPKP and SPKN, $A_V = +6dB$, $C_{IN} = 1\mu F$, 20Hz to 22kHz AC measurement bandwidth, $T_A = T_{MIN}$ to T_{MAX} , unless otherwise noted. Typical values are at $T_A = +25^\circ C$.) (Note 2)

PARAMETER	SYMBOL	CONDITIONS	MIN	TYP	MAX	UNITS	
ALC							
Attack Time				20		$\mu s/dB$	
Release Time				1.6		s/dB	
Maximum Attenuation				8		dB	
Attenuation Resolution				0.5		dB	
Knee Voltage	V_{KNEE}	$T_A = +25^\circ C$	$R_{KNEE} = 154k\Omega$	2.19	2.3	2.42	V
			$R_{KNEE} = 40.5k\Omega$	3.14	3.3	3.47	
			$R_{KNEE} = 13k\Omega$	3.71	3.9	4.10	
Knee Resistor	R_{KNEE}	$T_A = +25^\circ C$, $A_V = 15.5dB$	$V_{KNEE} = 3.25V$		43.2	k Ω	
			$V_{KNEE} = 3.35V$		37.4		
			$V_{KNEE} = 3.45V$		32.4		
			$V_{KNEE} = 3.55V$		27.4		
			$V_{KNEE} = 3.65V$		23.2		
			$V_{KNEE} = 3.75V$		18.7		
			$V_{KNEE} = 3.85V$		15.0		
DIGITAL INPUTS (\overline{SDBST}, \overline{SDSPK})							
Input Voltage High	V_{IH}		1.4			V	
Input Voltage Low	V_{IL}				0.4	V	
Input Capacitance	C_{IN}			10		pF	
Input Leakage Current	I_{IN}	$T_A = +25^\circ C$	-1.0		+1.0	μA	

Note 2: 100% production tested at $T_A = +25^\circ C$. Specifications over temperature limits are guaranteed by design.

Note 3: Amplifier inputs are AC-coupled to AGND.

Note 4: Mode transitions are controlled by \overline{SDSPK} .

Boosted 2.2W Class D Amplifier with Automatic Level Control

Typical Operating Characteristics

($V_{BAT} = 3.6V$, $R_L = \infty$ between SPKP and SPKN, $A_V = +15.5dB$, $R_{KNEE} = V_{BAT}$, 20Hz to 22kHz AC measurement bandwidth, unless otherwise noted.)

General

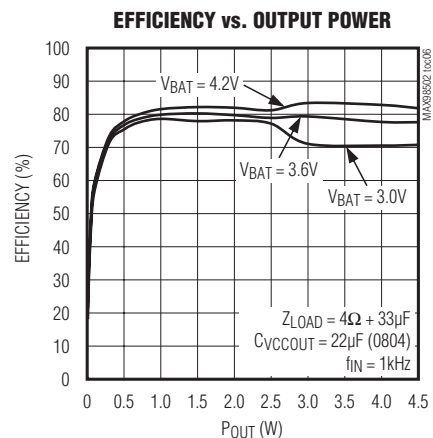
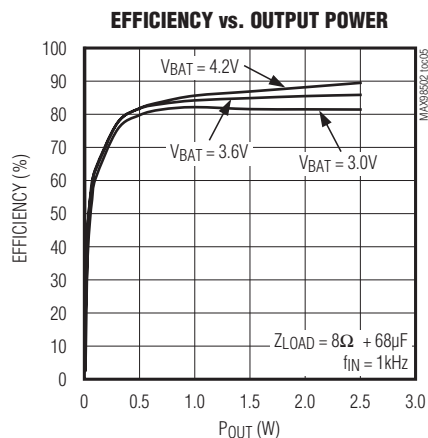
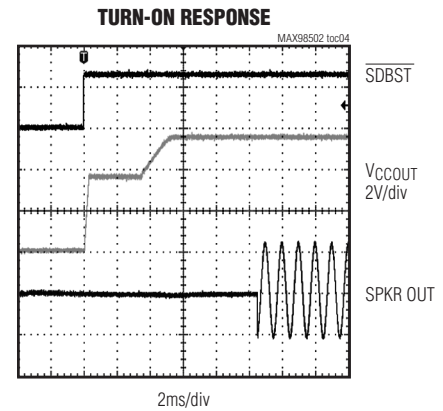
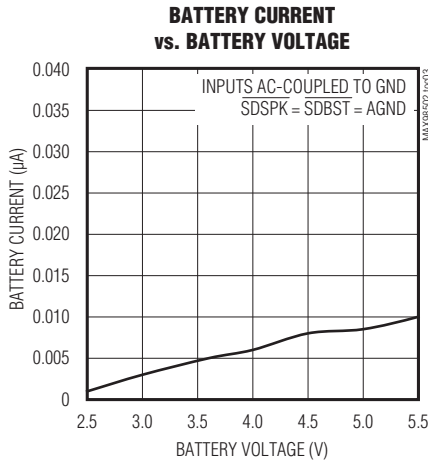
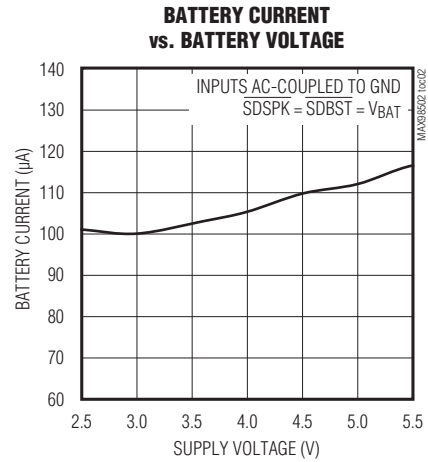
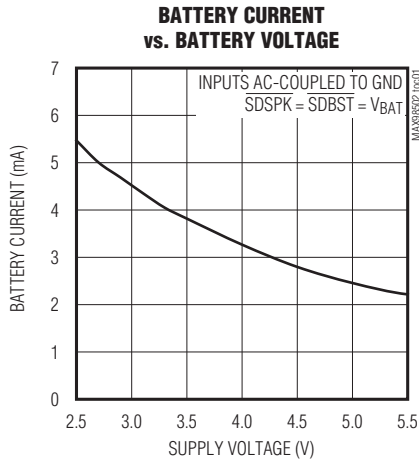

Boosted 2.2W Class D Amplifier with Automatic Level Control

Typical Operating Characteristics (continued)

($V_{BAT} = 3.6V$, $R_L = \infty$ between SPKP and SPKN, $A_V = +15.5dB$, $R_{KNEE} = V_{BAT}$, 20Hz to 22kHz AC measurement bandwidth, unless otherwise noted.)

Speaker

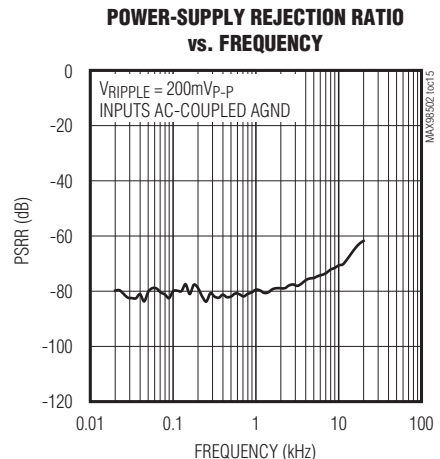
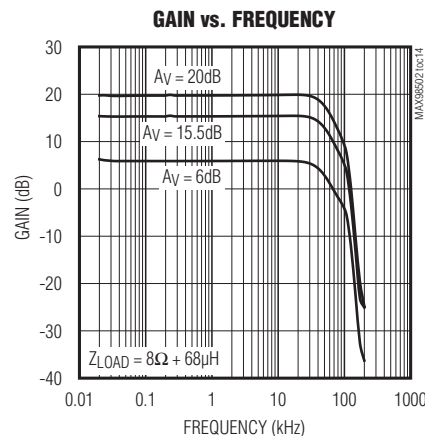
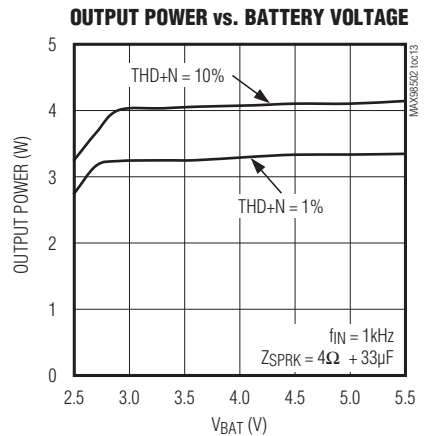
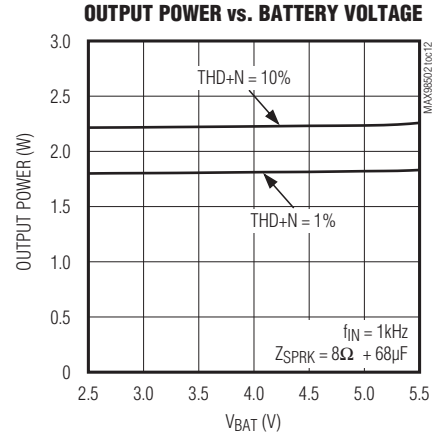
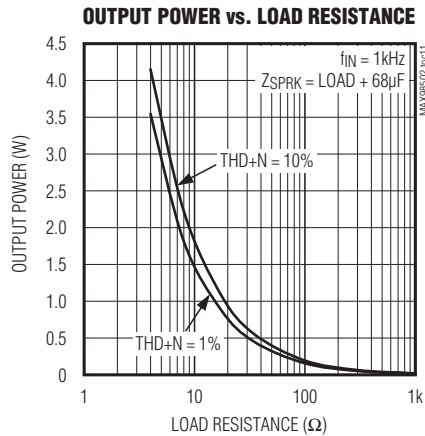
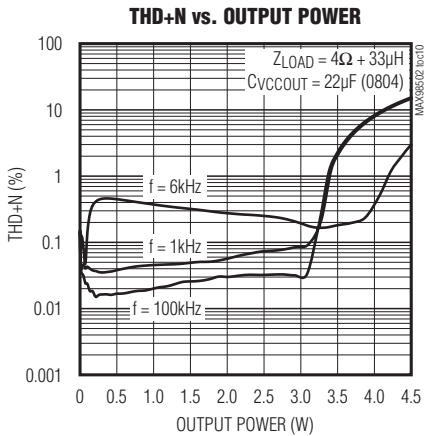
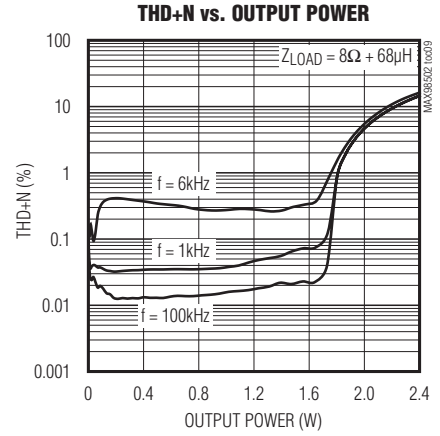
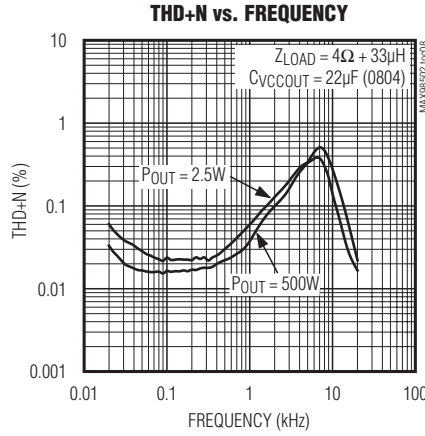
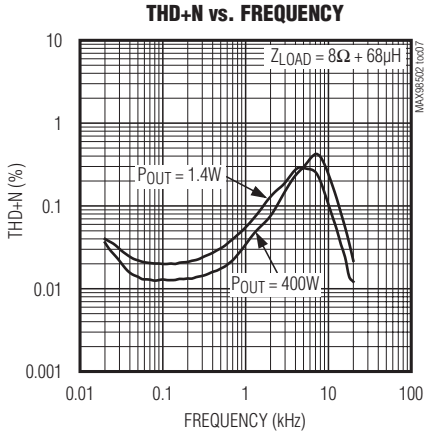

Boosted 2.2W Class D Amplifier with Automatic Level Control

Typical Operating Characteristics (continued)

($V_{BAT} = 3.6V$, $R_L = \infty$ between SPKP and SPKN, $A_V = +15.5dB$, $R_{KNEE} = V_{BAT}$, 20Hz to 22kHz AC measurement bandwidth, unless otherwise noted.)

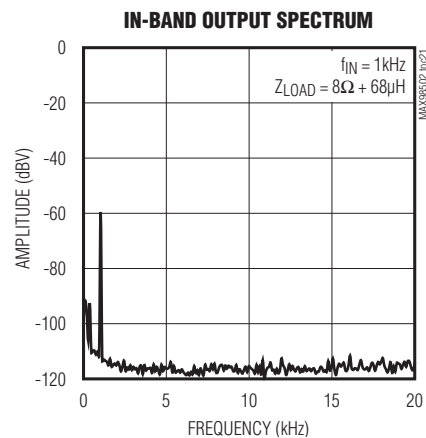
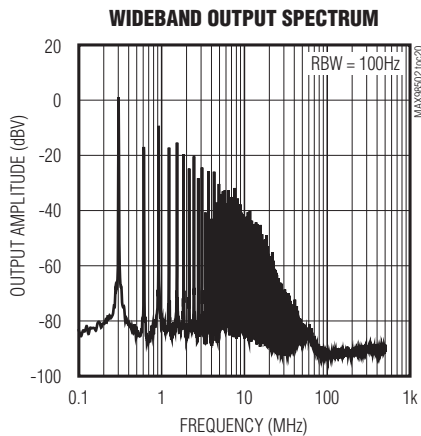
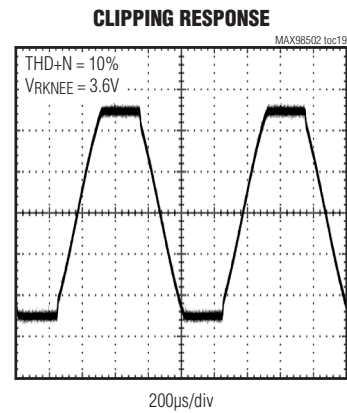
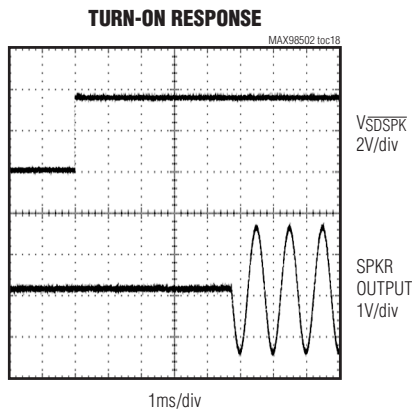
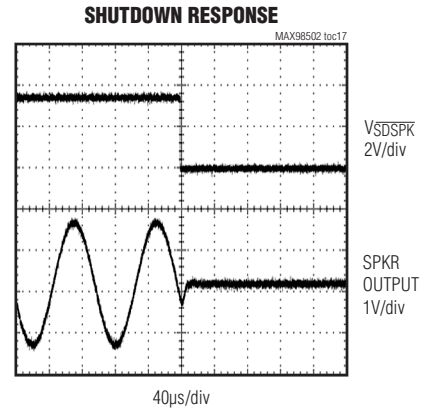
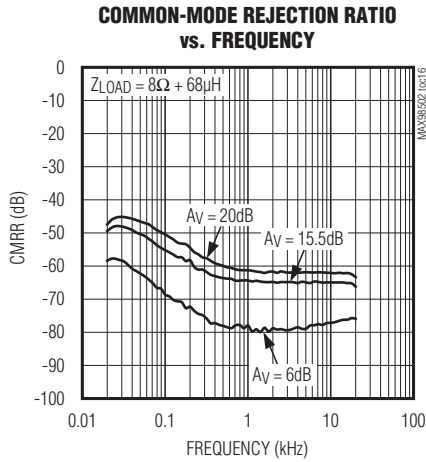

Boosted 2.2W Class D Amplifier with Automatic Level Control

Typical Operating Characteristics (continued)

($V_{BAT} = 3.6V$, $R_L = \infty$ between SPKP and SPKN, $A_V = +15.5dB$, $R_{KNEE} = V_{BAT}$, 20Hz to 22kHz AC measurement bandwidth, unless otherwise noted.)

Boost Converter

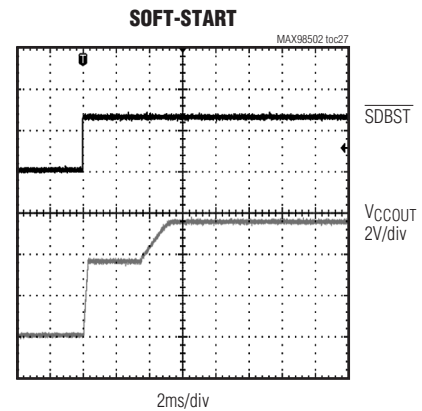
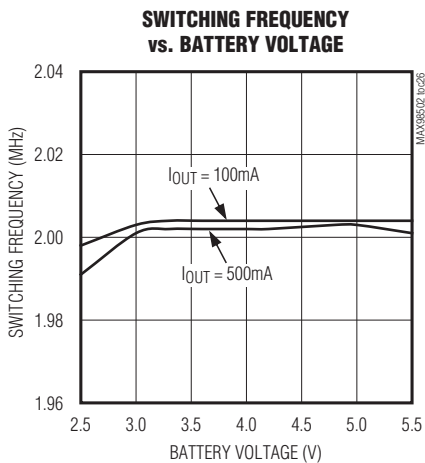
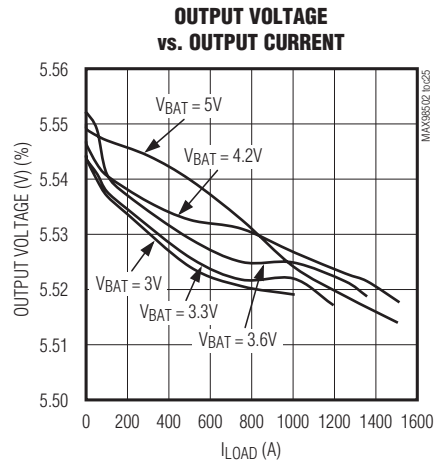
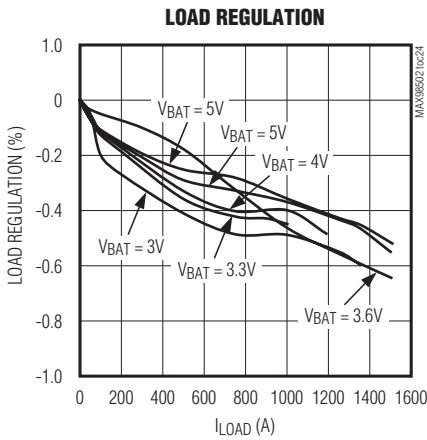
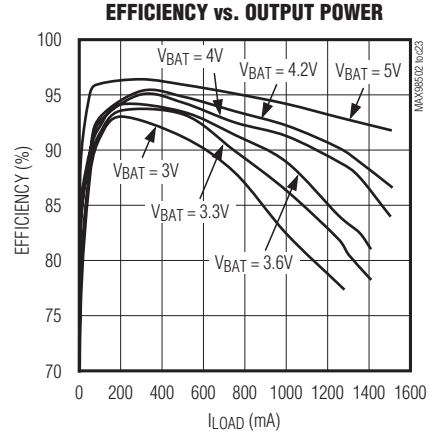
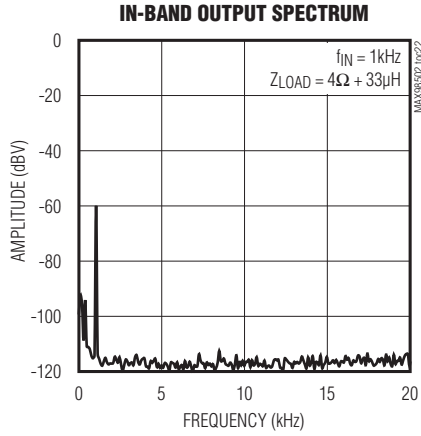

Boosted 2.2W Class D Amplifier with Automatic Level Control

Pin Configuration

MAX98502

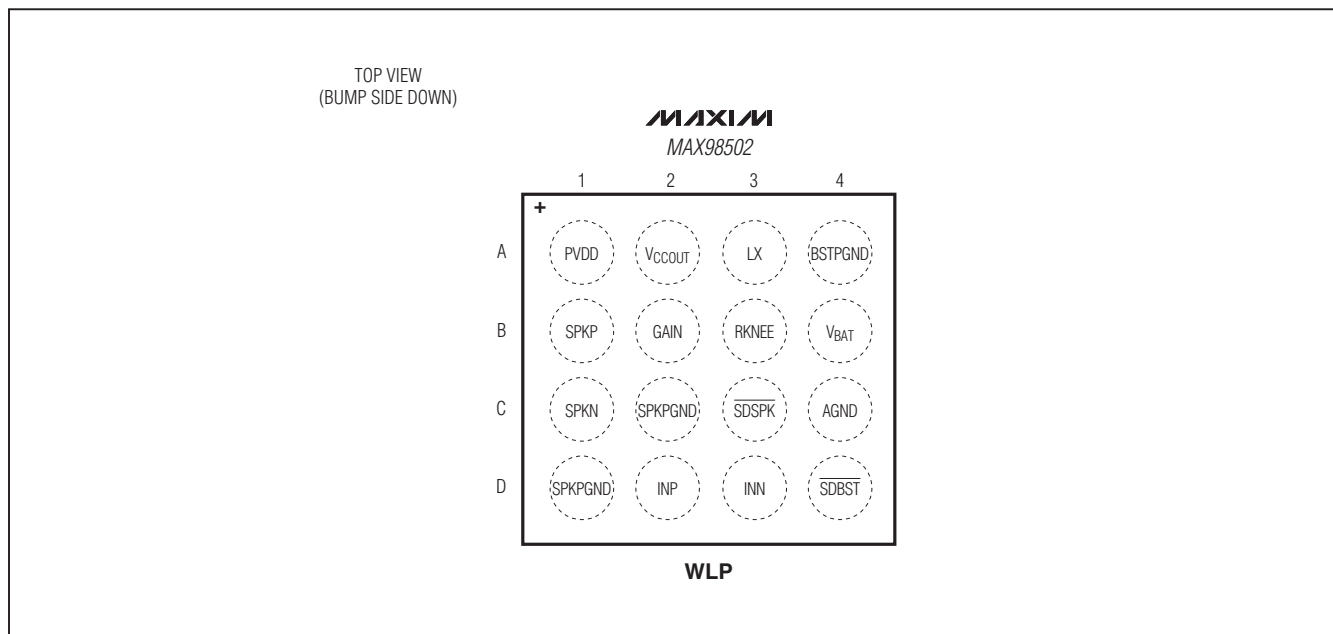

Pin Description

BUMP	NAME	FUNCTION
A1	PVDD	Speaker Amplifier Power Supply. Bypass to SPKPGND with a 0.1 μ F capacitor.
A2	VCCOUT	Boost Converter Output. Connect a 22 μ F (0805) capacitor between VCCOUT and BSTPGND.
A3	LX	Boost Switch Input
A4	BSTPGND	Boost Power Ground
B1	SPKP	Positive Speaker Output
B2	GAIN	Gain Select Input. Connect GAIN to ground to set the speaker gain to 6dB. Leave GAIN unconnected to set the speaker gain to 15.5dB. Connect GAIN to VBAT to set the speaker gain to 20dB.
B3	RKNEE	ALC Knee Voltage Set Input. Set the ALC knee voltage with a resistor to AGND.
B4	VBAT	Battery Voltage Input. Connect a 10 μ F (0805) capacitor between VBAT and BSTPGND. Include at least 22 μ F of system bulk capacitance.
C1	SPKN	Negative Speaker Output
C2, D1	SPKPGND	Speaker Ground
C3	SDSPK	Speaker Output Shutdown. Drive SDSPK low to shutdown the speaker output.
C4	AGND	Analog Ground
D2	INP	Positive Audio Input
D3	INN	Negative Audio Input
D4	SDBST	Boost Converter Shutdown. Drive SDBST low to shutdown the boost converter and the speaker output.

Boosted 2.2W Class D Amplifier with Automatic Level Control

Detailed Description

The MAX98502 is a high-efficiency Class D audio amplifier that features an integrated boost converter to deliver a constant output power over a large range of battery supply voltages. The boost converter operates at 2MHz, requiring only a small (2.2μH) external inductor and output capacitor. The amplifier has differential inputs and an internal fully differential design with three gain settings (6dB, 15.5dB, and 20dB) that are selectable with a logic input.

The MAX98502 also features automatic level control. The automatic level control reduces the output swing when the battery voltage decreases to prevent the collapse of battery voltage.

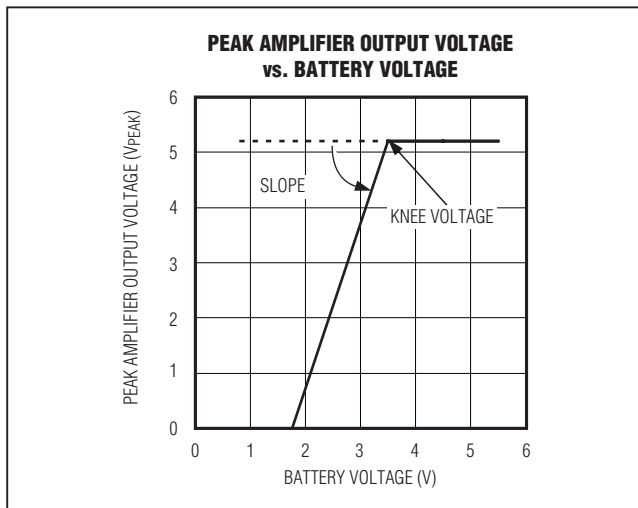

Figure 1. Typical Tracking Function

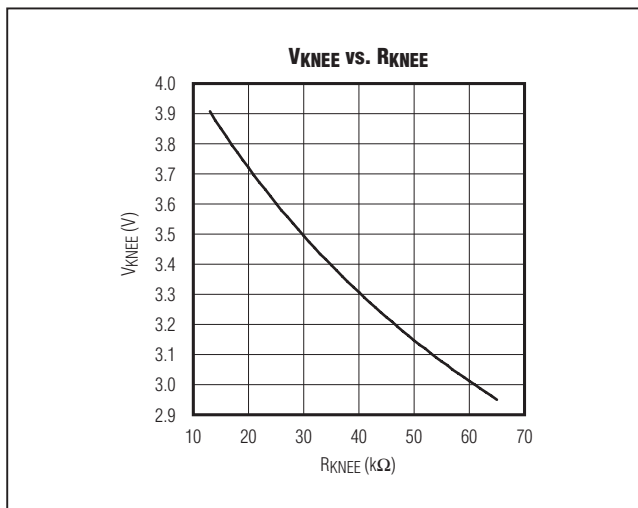

Figure 2. The Relationship of R_{KNEE} and V_{KNEE}

Class D Speaker Amplifier

The MAX98502 filterless Class D amplifier offers much higher efficiency than Class AB amplifiers. The high efficiency of a Class D amplifier is due to the switching operation of the output stage transistors. Any power loss associated with the Class D output stage is mostly due to the I²R loss of the MOSFET on-resistance and quiescent current overhead.

Low-EMI Filterless Output Stage

Traditional Class D amplifiers require the use of external LC filters, or shielding, to meet EN55022B electromagnetic-interference (EMI) regulation standards. Maxim's active emissions limiting edge-rate control circuitry reduces EMI emissions, while maintaining up to 92% efficiency (speaker only). Above 10MHz, the wideband spectrum looks like noise for EMI purposes.

Automatic Level Control

The MAX98502 features an automatic level control circuit that limits the maximum speaker output swing. This helps:

- Avoid clipping
- Save the battery from collapsing, which could cause a reset of the system

The limiter keeps the peak voltage below a value that is a function of battery voltage, as shown in Figure 1.

The full output swing of 5.2V is maintained for battery voltages down to the knee voltage, while for lower battery voltages the maximum V_{PEAK}-swing is reduced by 3V/V.

The knee voltage can be changed by applying different resistors between R_{KNEE} and AGND. The typical tracking function is shifted horizontally with different R_{KNEE} resistor values (Figure 2).

The preamplifier gain reduces as the automatic level control activates. The maximum gain reduction is 8dB with a resolution of 0.5dB steps.

The attack (gain reduction) happens immediately (20μs/dB), while the release is set to 1.6s/dB.

GAIN Select

The MAX98502 features three internal gain settings that are selectable with the GAIN input. Table 1 shows the gain settings.

Table 1. Gain Settings

GAIN	AMPLIFIER GAIN (dB)
AGND	6
Unconnected	15.5
V _{BAT}	20

Boosted 2.2W Class D Amplifier with Automatic Level Control

Table 2. Shutdown Configurations

$\overline{\text{SDBST}}$	$\overline{\text{SDSPK}}$	BOOST STATUS	SPEAKER STATUS
Low	Low	Off	Off
Low	High	Off	Off
High	Low	On	Off
High	High	On	On

Shutdown

The MAX98502 features two active-low shutdown inputs ($\overline{\text{SDSPK}}$ and $\overline{\text{SDBST}}$). Table 2 shows the different shutdown configurations.

Click-and-Pop Suppression

The MAX98502 speaker amplifier features Maxim's comprehensive click-and-pop suppression. During startup, the click-and-pop suppression circuitry reduces any audible transient sources internal to the device. When entering shutdown, the differential speaker outputs ramp down to SPKPGND quickly and simultaneously.

Current-Limit and Thermal Protection

The IC features overcurrent and thermal protection. The IC shuts down when the V_{CCOUT} output decreases to about 80% of the expected output. The IC also enters into shutdown when the die temperature exceeds +165°C. The device remains in shutdown until power is reset or $\overline{\text{SDBST}}$ is toggled low and back high after the fault condition has been removed. The IC speaker amplifier also features a 2A (typ) short-circuit protection scheme.

Boost Converter

Soft-Start

The MAX98502 features a two-stage, soft-start, power-up sequence. When $\overline{\text{SDBST}}$ is taken high and V_{BAT} is above UVLO the soft-start first ramps V_{CCOUT} quickly to V_{BAT} voltage with a battery current of 300mA (typ). Once the V_{CCOUT} reaches the V_{BAT} voltage, the internal switching turns on and ramps the V_{CCOUT} to 5.5V in 5ms (typ), see the Soft-Start graph in the *Typical Operating Characteristics*. The maximum load current is available after the soft-start is completed.

Undervoltage Lockout (UVLO)

The undervoltage lockout (UVLO) circuit compares the voltage at V_{BAT} with the UVLO threshold (2.2V typ) to ensure that the input voltage is high enough for reliable operation. Once the V_{BAT} voltage exceeds the UVLO

threshold, the soft-start begins. When the input voltage falls below the UVLO threshold, the boost converter and speaker amplifier turn off.

Applications Information

Filterless Class D Operation

Traditional Class D amplifiers require an output filter to recover the audio signal from the amplifier's output. The filter adds cost, increases the solution size of the amplifier, and can decrease efficiency and THD+N performance. The traditional PWM scheme uses large differential output swings (2 x supply voltage peak-to-peak) and causes large ripple currents. Any parasitic resistance in the filter components results in a loss of power and lowers the efficiency.

The MAX98502 does not require an output filter. The device relies on the inherent inductance of the speaker coil and the natural filtering of both the speaker and the human ear to recover the audio component of the square-wave output. Eliminating the output filter results in a smaller, less costly, and more efficient solution.

Because the frequency of the MAX98502 output is well beyond the bandwidth of most speakers, voice coil movement due to the square-wave frequency is very small. Although this movement is small, a speaker not designed to handle the additional power can be damaged. For optimum results, use a speaker with a series inductance > 10 μ H. Typical 8 Ω speakers exhibit series inductances in the 20 μ H to 100 μ H range.

RF Susceptibility

GSM radios transmit using time-division multiple access (TDMA) with 217Hz intervals. The result is an RF signal with strong amplitude modulation at 217Hz and its harmonics that is easily demodulated by audio amplifiers. The MAX98502 is designed specifically to reject RF signals; however, PCB layout has a large impact on the susceptibility of the end product.

In RF applications, improvements to both layout and component selection decrease the MAX98502's susceptibility to RF noise and prevent RF signals from being demodulated into audible noise. Trace lengths should be kept below 1/4 of the wavelength of the RF frequency of interest. Minimizing the trace lengths prevents them from functioning as antennas and coupling RF signals into the MAX98502. The wavelength (λ) in meters is given by: $\lambda = c/f$ where $c = 3 \times 10^8$ m/s, and f = the RF frequency of interest.

Boosted 2.2W Class D Amplifier with Automatic Level Control

Route audio signals on the middle layers of the PCB to allow the ground planes above and below to shield them from RF interference. Ideally the top and bottom layers of the PCB should primarily be ground planes to create effective shielding.

Additional RF immunity can also be obtained from relying on the self-resonant frequency of capacitors as it exhibits the frequency response similar to a notch filter. Depending on the manufacturer, 10pF to 20pF capacitors typically exhibit self resonance at RF frequencies. These capacitors, when placed at the input pins, can effectively shunt the RF noise at the inputs of the MAX98502. For these capacitors to be effective, they must have a low-impedance, low-inductance path to the ground plane. Do not use microvias to connect to the ground plane as these vias do not conduct well at RF frequencies.

Speaker Component Selection

Optional Ferrite Bead Filter

Additional EMI suppression can be achieved using a filter constructed from a ferrite bead and a capacitor to ground (Figure 3). Use a ferrite bead with low DC resistance, high-frequency (> 100MHz) impedance between 100Ω and 600Ω, and rated for at least 1A for an 8Ω load and 2A for a 4Ω load. The capacitor value varies based on the ferrite bead chosen and the actual speaker lead length. Select a capacitor less than 1nF based on EMI performance.

Input Capacitor (C_{IN})

An input capacitor, C_{IN}, in conjunction with the input impedance of the MAX98502 speaker inputs forms a highpass filter that removes the DC bias from an incoming analog signal. The AC-coupling capacitor allows the amplifier to automatically bias the signal to an optimum DC level. Assuming zero-source impedance, the -3dB point of the highpass filter is given by:

$$f_{-3dB} = \frac{1}{2\pi R_{IN} C_{IN}}$$

Choose C_{IN} such that f_{-3dB} is well below the lowest frequency of interest. For best audio quality, use capacitors whose dielectrics have low-voltage coefficients, such as tantalum or aluminum electrolytic. Capacitors with high-voltage coefficients, such as ceramics, could result in increased distortion at low frequencies.

Boost Converter Component Selection

Inductor Selection

In most step-up converter designs, a reasonable inductor value can be derived from the following equation. This equation sets peak-to-peak inductor current at 1/2 the DC inductor current:

$$L = (2 \times V_{BATT} \times D \times (1-D)) / (I_{OUT(MAX)} \times f_{SW})$$

where f_{SW} is the switching frequency, and D is the duty factor given by D = 1 - (V_{BAT}/V_{OUT}). Using L from the equation above results in a peak-to-peak inductor current ripple of 0.5 × I_{OUT}/(1 - D), and a peak inductor current of 1.25 × I_{OUT}/(1 - D). Ensure the peak (saturation) current rating of the inductor meets or exceeds this requirement.

The recommended nominal inductance for the MAX98502 is 2.2μH. Nominal inductance decreases as the inductor current increases. If the decrease from the nominal inductance is severe, the boost converter may become unstable or shut down at lower output power levels than expected. Ensure the minimum inductance at the peak inductor current is 1.0μH.

Output Capacitor (C_{VCCOUT})

An output capacitor, C_{VCCOUT}, is required to keep the output voltage ripple small and to ensure regulation loop stability. The output capacitor must have low impedance at the switching frequency. Ceramic capacitors are highly recommended due to their small size and low ESR. Ceramic capacitors with X5R or X7R temperature characteristics generally perform well. The recommended nominal capacitance for the MAX98502 is 22μF (0805 case size or larger). Ensure the minimum capacitance at 5.5V is 6.8μF.

Input Capacitor (C_{VBAT})

An input capacitor, C_{VBAT}, reduces the current peaks drawn from the battery or input power source and reduces switching noise in the IC. The impedance of the input capacitor at the switching frequency should be kept very low. Ceramic capacitors are highly recommended due to their small size and low ESR. Ceramic capacitors with X5R or X7R temperature characteristics generally perform well. One 10μF ceramic capacitor is recommended with a system bulk capacitance of 22μF or larger.

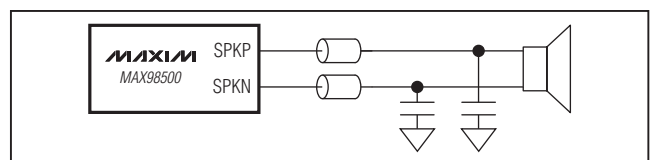

Figure 3. Optional Class D Ferrite Bead Filter

Boosted 2.2W Class D Amplifier with Automatic Level Control

Supply Bypassing, Layout, and Grounding

Proper layout and grounding are essential for optimum performance. Use a large continuous ground plane on a dedicated layer of the PCB to minimize loop areas. Connect AGND and BSTPGND/SPKPGND directly to the ground plane using the shortest traces length possible. Proper grounding improves audio performance, and prevents any digital noise from coupling into the analog audio signals.

Bypass V_{BAT} with a $10\mu\text{F}$ capacitor and a system bulk capacitance of $22\mu\text{F}$ or larger. Bypass $PVDD$ to $SPKPGND$ with a $0.1\mu\text{F}$ capacitor and with as minimal a loop area as possible. Connect $SPKP$ and $SPKN$ to the speaker using the shortest and widest traces possible. Reducing trace length minimizes radiated EMI. Route $SPKP/SPKN$ as a differential pair on the PCB to minimize loop area, thereby, the inductance of the circuit. If filter components are used on the speaker outputs, be sure to locate them as close as possible to the MAX98502 to ensure maximum effectiveness. Minimize the trace length from any ground-tied passive components to $SPKPGND$ to further minimize radiated EMI.

An evaluation kit (MAX98502 Evaluation Kit) is available to provide an example layout for the MAX98502.

WLP Applications Information

For the latest application details on WLP construction, dimensions, tape carrier information, PCB techniques, bump-pad layout, and recommended reflow temperature profile, as well as the latest information on reliability testing results, refer to the Application Note 1891: *Wafer-Level Packaging (WLP) and Its Applications* on Maxim's website at www.maxim-ic.com/ucsp. See Figure 4 for the recommended PCB footprint for the MAX98502.

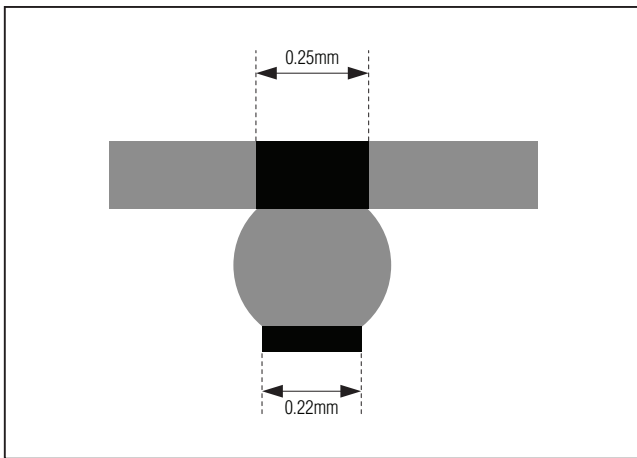
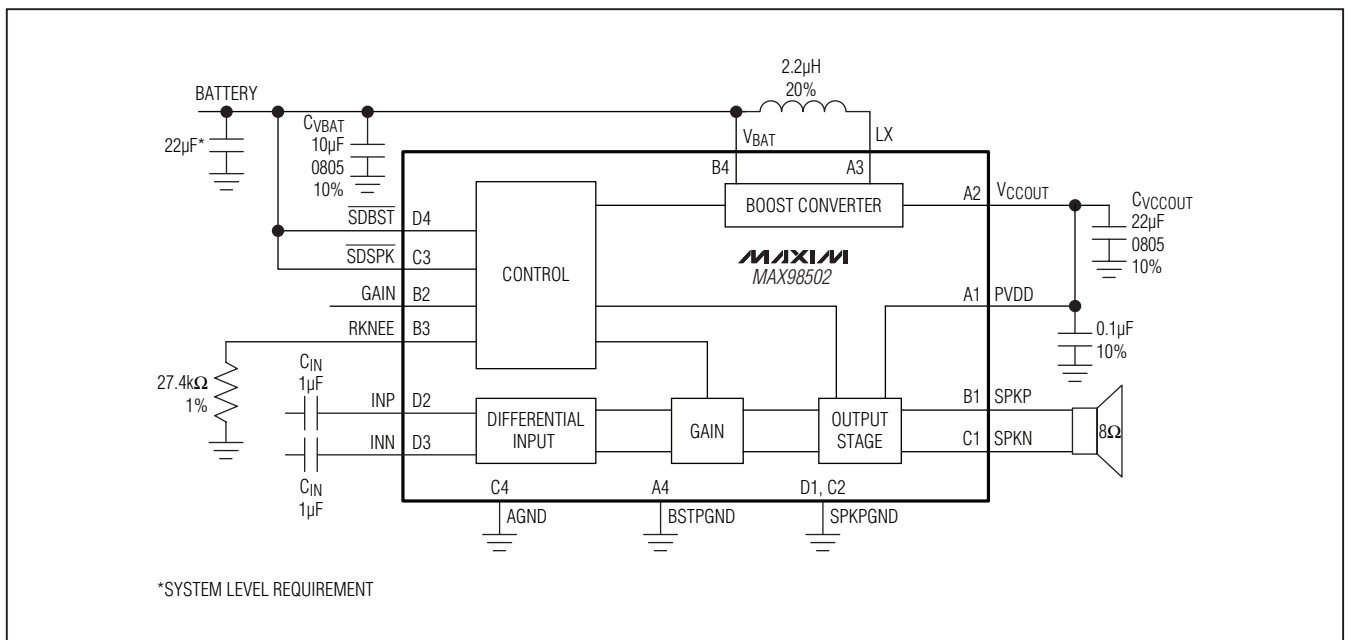

Figure 4. Recommended PCB Footprint

Typical Application Circuit



Boosted 2.2W Class D Amplifier with Automatic Level Control

Package Information

For the latest package outline information and land patterns, go to www.maxim-ic.com/packages. Note that a "+", "#", or "-" in the package code indicates RoHS status only. Package drawings may show a different suffix character, but the drawing pertains to the package regardless of RoHS status.

PACKAGE TYPE	PACKAGE CODE	OUTLINE NO.	LAND PATTERN NO.
16 WLP	W162B2+1	21-0200	Refer to Application Note 1891

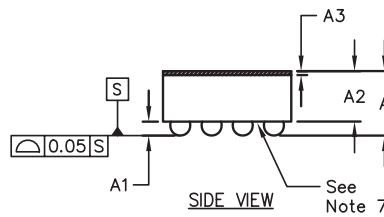
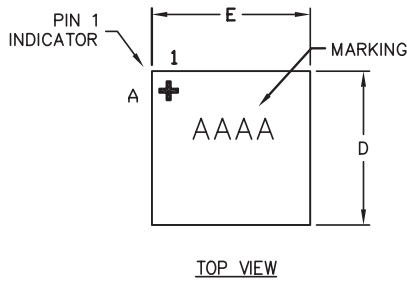

COMMON DIMENSIONS	
A	0.64±0.05
A1	0.24±0.03
A2	0.40 REF
A3	0.025 BASIC
b	∅0.31±0.03
D1	1.50 BASIC
E1	1.50 BASIC
e	0.50 BASIC
SD	0.25 BASIC
SE	0.25 BASIC

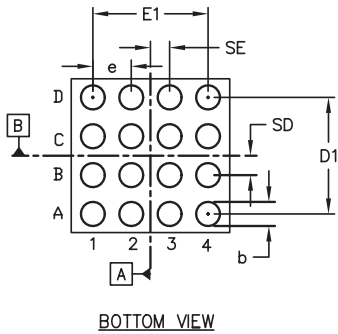

PKG. CODE	E		D		DEPOPULATED BUMPS
	MIN	MAX	MIN	MAX	
W162B2+1	1.98	2.11	1.98	2.11	NONE
W162C2+1	2.12	2.26	1.99	2.13	NONE
W162D2+1	1.99	2.01	1.99	2.01	B3, C2

NOTES:

1. Terminal pitch is defined by terminal center to center value.
2. Outer dimension is defined by center lines between scribe lines.
3. All dimensions in millimeters.
4. Marking shown is for package orientation reference only.
5. Tolerance is ± 0.02mm unless specified otherwise.
6. All dimensions apply to PbFree (+) package codes only.
7. Front-side finish can be either Black or Clear.

-DRAWING NOT TO SCALE-

MAXIM		
TITLE: PACKAGE OUTLINE 16 BUMPS, WLP PKG. 0.5mm PITCH		
APPROVAL	DOCUMENT CONTROL NO. 21-0200	REV. E 1/1