

MAX9972 Evaluation Kit

Evaluates: MAX9972

General Description

The MAX9972 evaluation kit is a fully assembled and tested printed circuit board (PCB) that simplifies evaluation and demonstrates the functionality of the MAX9972, a quad-channel, ultra-low power pin electronics IC. The MAX5734 DAC is included in the EV kit for pin electronic IC level setting. Standard 50Ω SMA connectors are included on the EV kit for the inputs and outputs to allow for quick and easy evaluation on the test bench.

The EV kit contains a microcontroller (MCU) that translates between the SPI interface and USB to allow the user to configure internal registers and modes with graphical user interface (GUI) software running on a PC. The EV kit includes Windows® 10-compatible software that provides a simple GUI for configuration of all the MAX9972 registers through SPI. The EV kit is fully assembled and tested at the factory.

This document includes the [MAX9972 EV Kit Bill of Materials](#), a list of equipment required to evaluate the device, a straightforward test procedure to verify functionality, a description of the EV kit circuit, [MAX9972 EV Kit Schematic Diagrams](#), and [MAX9972 EV Kit PCB Layout Diagrams](#).

Features

- Easy Evaluation of MAX9972 Quad-Channel DCL and PMU Switches
- On-Board MAX5734 2-Channel, 16-Bit DAC
- On-Board MAX32625 Pico Board
- Includes Heatsink
- On-Board Voltage Regulators
- USB Interface
- Headers for External SPI Interface
- Proven PCB Layout
- Fully Assembled and Tested

Ordering Information appears at end of data sheet.

Windows is a registered trademark and registered service mark of Microsoft Corporation.

Arm and Cortex are registered trademarks of Arm Limited (or its subsidiaries) in the US and/or elsewhere.

Quick Start

Required Equipment

This section lists the recommended test equipment to verify operation of the MAX9972. It is intended as a guide only and some substitutions are possible.

- MAX9972 EV kit
- A user-supplied Windows 10-compatible PC with a spare USB 2.0 port
- Dual-output DC power supply
 - +8V/500mA
 - -5V/500mA
- Function/pulse generator (recommend high speed up to 250MHz)
- High-speed oscilloscope (recommend 1GHz bandwidth)
- Digital multimeter
- SMA/SMA cable as needed for connection to the equipment

Software and Drivers

The MAX9972 EV kit is used in conjunction with the Arm® Cortex® M4 processor with FPU, MAX32625PICO application platform or PICO board to provide power and control the device through a software application or GUI. Users also have the option to connect SPI through their system with J1 header on the EV kit.

Install the MAX9972 EV Kit GUI Software

This process takes less than 10 minutes after downloading the software package.

- Download the MAX9972 EV kit software from www.maximintegrated.com/evkit-software, run the installation file, and install the GUI package.
- Run the GUI program.

Powering the MAX9972 EV Kit

- Set the DC supply to +8V and connect (through an ammeter if desired) to the headers (VCC) and ground (GND) on the EV kit. Do not turn on the supply.
- Set the DC supply to -5V and connect (through an ammeter if desired) to the headers (VEE) and ground (GND) on the EV kit. Do not turn on the supply.

- There are on-board linear regulators to power the MAX9972 VL and VCTV and the MAX5734 32-channel DAC, connect jumpers in default position, as shown in [Table 1](#) and [Table 2](#).
- Verify that the heatsink is installed and flush on the top of the MAX9972 IC.

Procedure

This section provides a step-by-step guide to operating the EV kit and testing the device functions.

Caution: Do not turn on the DC power or function generator until all connections are completed. Connect all power-supply grounds to a single ground terminal.

- 1) Set the function generator to output peak-to-peak amplitude of 500mV with offset +250mV. Ensure that the outputs are disabled (high impedance). Set the square wave frequency to 20MHz, 50% duty cycle.
- 2) Connect the function generator output to the DATA1 SMA connector on the MAX9972 EV kit with a SMA cable.
- 3) Set the RCV1 to a 50Ω terminator to disable the high-impedance output mode.
- 4) Connect the DUT1 SMA connector of the MAX9972

- 5) EV kit with a short SMA cable to the high-speed oscilloscope. Set the scope input impedance to 50Ω.
- 5) Verify the correct polarity, voltage, and current limit of all power supplies. Turn on the power supplies and function generator.
- 6) Connect the PC to the on-board MAX32625 PICO microcontroller module on the EV kit using the provided USB cable.
- 7) Select the COM port and click on the **Connect** button. The MAX9972 GUI should indicate EV kit connected in the status bar (outlined in blue), as shown in [Figure 2](#).
- 8) Put the EV kit into drive mode by setting register values as shown on the **Channel 1** tab, as shown in [Figure 1](#). In this mode, **VDH Level Voltage** is set to 3.00 and **VDL Level Voltage** is set to 0.00 for Channel 1.
- 9) Click on the **Write Ch1** button to write the data into the MAX9972 and MAX5734 registers.
- 10) Set the oscilloscope to trigger on the DUT1 channel, with the trigger level set to 0.5V. Set the time base to 20ns per division. A 0 to 1.5V square wave of 20MHz should appear on the oscilloscope.

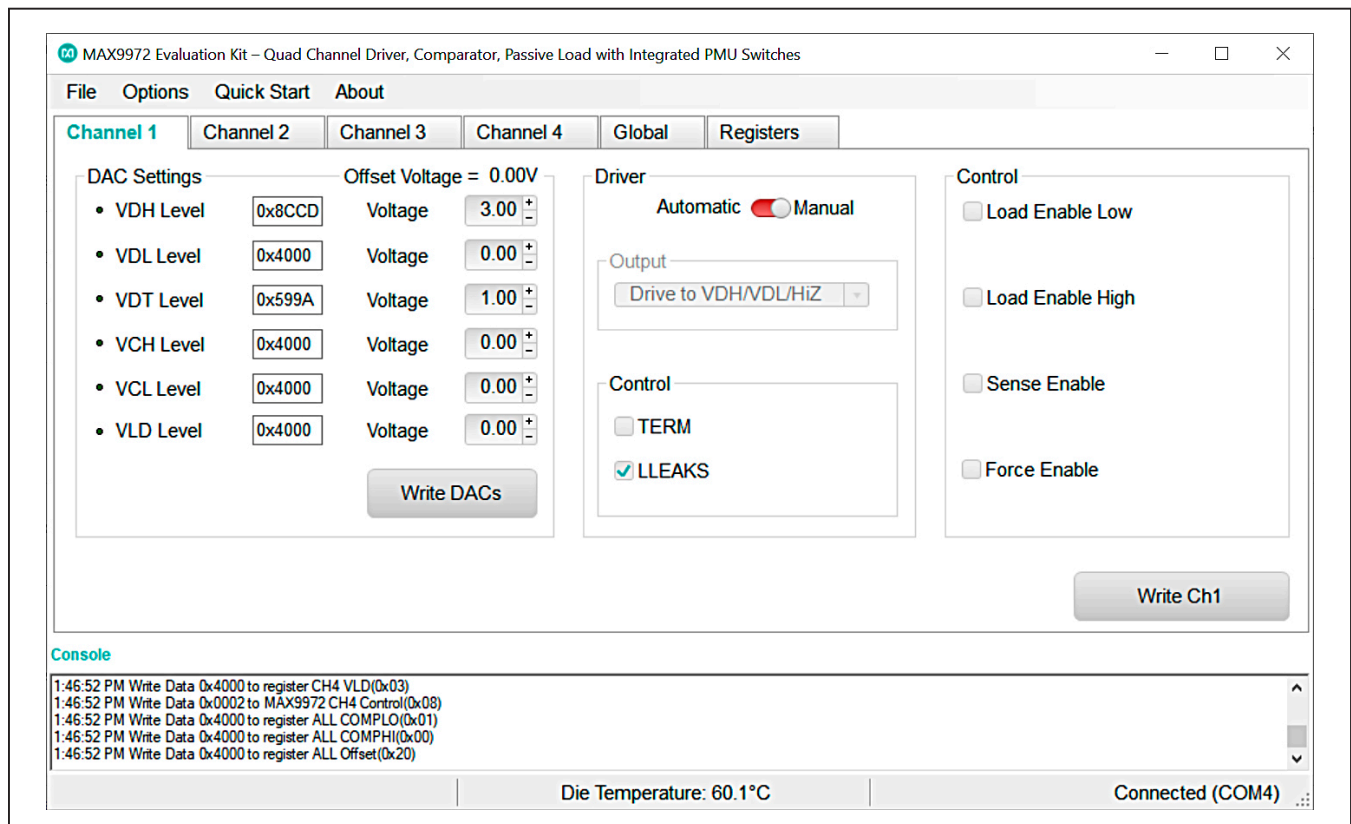

Figure 1. MAX9972 EV Kit Software Main Window (Ch1 Tab)

Detailed Description

Detailed Description of Software

The MAX9972 GUI is organized into six tabs for all level setting registers and control signal settings, plus the **File** menu to save and load all these settings. There are identical tabs that control the four channels of the MAX9972. The **Global** tab contains level-setting DAC controls shared across all four channels. The **Registers** tab consists of all the user registers in the MAX9972 and MAX5734.

Channel Tab

Channel 1, Channel 2, Channel 3, and Channel 4 are identical and control each of the MAX9972 channels independently. These tabs contain **Level-Setting DACs** and **Channel Control**, as shown in [Figure 2](#). After setting DAC levels and control signals, click on the **Write Ch_** button to load data into the MAX9972 device through the SPI interface.

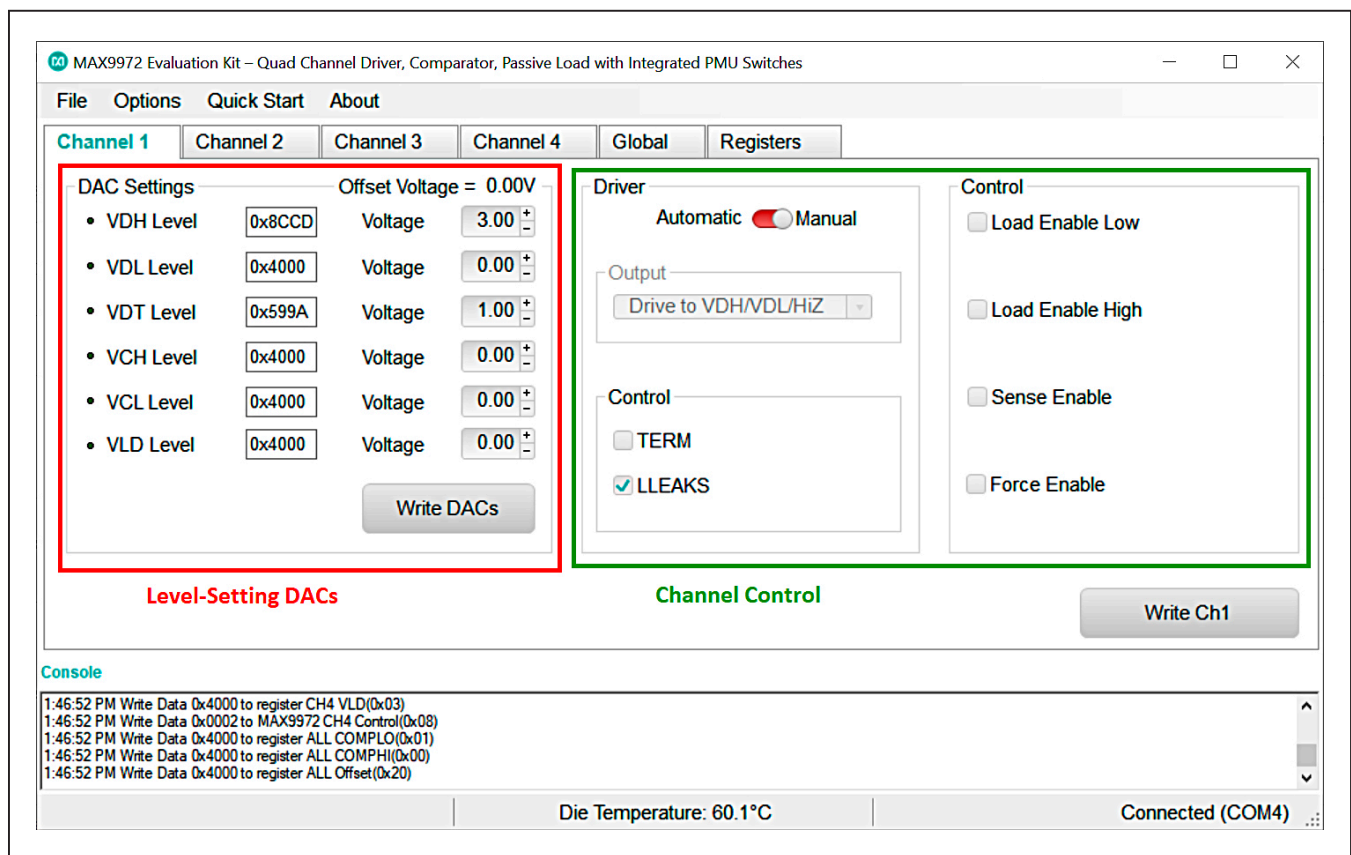

Figure 2. MAX9972 EV Kit Software Window (Level-Setting DACs and Control Register)

Level-Setting Channel DACs

The Level Setting Channel DACs group box contains signal level registers for **VDH**, **VDL**, **VDT**, **VCH**, **VCL**, and **VLD** level settings. Each voltage level can be set by entering value either in voltage box or hexadecimal box. Finer adjustment can be made by clicking on the +/- sign of the **Voltage** box. The **VDHV**, **VDLV**, **VDTV**, **VCHV**, **VCLV**, and **VLDV** voltage have 65,536 steps corresponding to 16 bits.

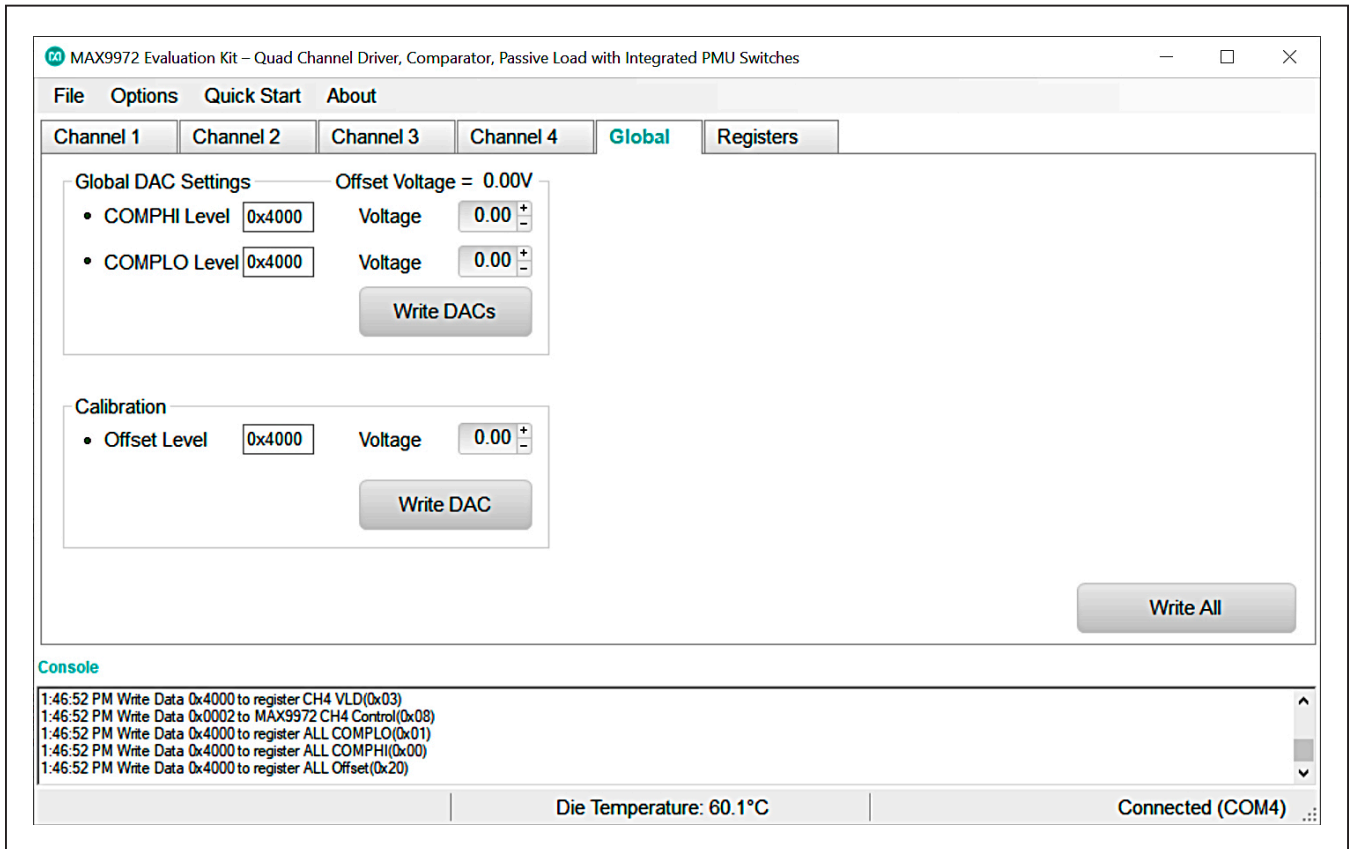

Figure 3. MAX9972 EV Kit Software Window (Level-Setting Channel DACs)

Channel Control Register

Channel control register is a combination of **Driver** and **Control** group boxes.

Driver output is chosen by setting the **Automatic** or **Manual** toggle button in the **Driver** group box. In automatic mode, driver output is selected from the **Output** drop-down box. In manual mode, driver output is selected based on the **Control** group box settings.

Passive load can be enabled or disabled with the **Load Enable Low** and **Load Enable High** check boxes. PMU switches can be enabled or disabled with **Sense Enable** and **Force Enable** check boxes.

Global Tab

The **Global** tab sheet (Figure 3) contains **Global DACs Settings** and **Offset Voltage** settings. **COMPHI Level** and **COMPLO Level** DAC's voltage level can be set by entering value either in the **Voltage** box or in the hexadecimal box. Offset level of the DAC can be set by entering value either in the **Voltage** box or in the hexadecimal box.

Registers Tab

There are two methods for configuring the MAX9972 and MAX5734 devices. The first method is through the graphical user interface as shown in Figure 2. The second method is through the **Registers** tab as shown in Figure 4. The **Registers** tab allows execution of serial commands manually. The **Registers** tab can also be used as a debug tool because it is capable of writing to every register of the MAX9972 and MAX5734.

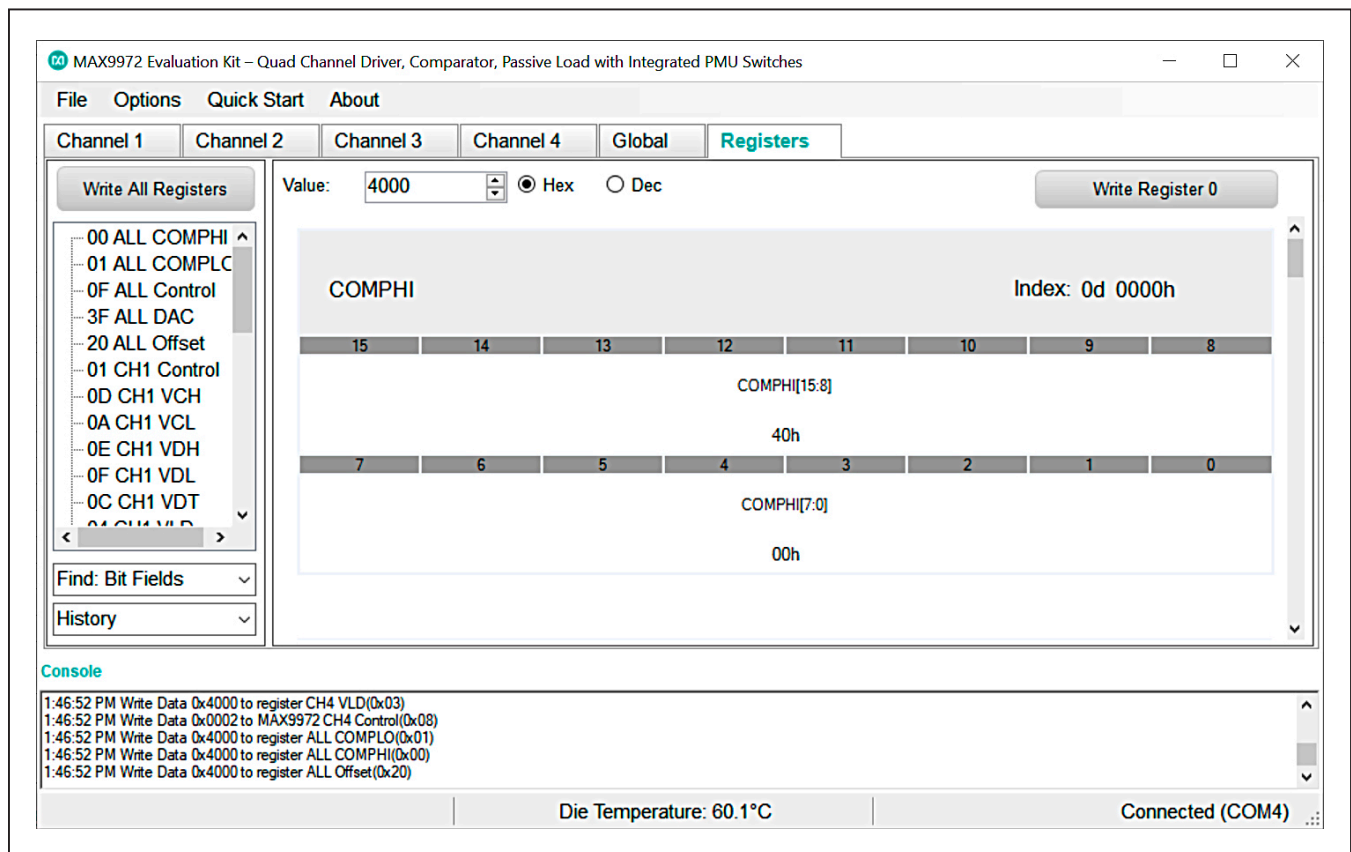

Figure 4. MAX9972 EV Kit Software Window (Register Tab)

Detailed Description of Hardware

The MAX9972 evaluation kit is a fully assembled and tested PCB that evaluates the MAX9972 quad-channel, ultra-low power pin electronic driver, comparator, passive load, and PMU switches. The EV kit includes SMA connectors for the high-speed digital I/Os. The MAX9972 EV kit is connected to a computer through the universal serial bus (USB) port.

Power Supplies

Connect the power supplies using the high-current banana jacks, VEE (-5V) and VCC (8V). The GND banana jack on the MAX9972 EV kit is common for all the power supplies. All power supplies should be within the range specified in the MAX9972 IC data sheet. The MAX9972 EV kit needs only two supplies to be connected to the board; all other supplies are generated through regulators on the EV kit.

High-Speed Digital I/Os

The top edge and the bottom edge of the PCB are populated with edge-launch SMA connectors and are the high-speed digital I/Os of the MAX9972. It is recommended that the CMPH_ and CMPL_ outputs are connected to 50Ω terminated oscilloscope/logic analyzer at the end of the attached cable.

The high-speed digital inputs (DATA_ and RCV_) are intended for use with a high-speed, single-ended signal source. The high-speed digital outputs (CMPH_/CMPL_) are intended for use with a high-speed differential logic analyzer. These outputs can be double terminated at the measurement source by external 50Ω resistors.

Pin Driver Outputs

The quad-pin driver output pins (DUT_) are accessed through the edge launch SMA connectors, located on the right edge of the PCB. The outputs have a typical output impedance of 50Ω.

Test Points

There are test points on the EV kit to facilitate performance analysis and circuit modification. The test points are listed in [Table 3](#).

Device Ground Sense

The MAX5734 IC can sense the ground potential at the device under test (DUT). The MAX5734 is preconfigured to have the device ground sense pin (DGS) connected to the ground plane through a 0Ω resistor (R9). If remote sensing is desired, remove R9 and connect DGS pin to the remote DUT ground.

Temperature Sensing

The MAX9972 EV kit provides the means to determine the MAX9972 IC's die temperature through the TEMP test point. During operation, continuously monitor the TEMP pin to ensure that the junction temperature does not exceed +150°C, which corresponds with +4.2V. During normal operation, a voltage of 3V to 3.6V is typical. The MAX9972 GUI provides another way to monitor die temperature.

Jumper Settings

[Tables 1, 2](#) and [3](#) provide a list for jumper settings.

Table 1. Power Supplies Jumper Settings

JUMPER	SHUNT POSITION	DESCRIPTION
J2	1-2*	Connects VEE to the negative power-supply input banana jack
	Open†	Disconnects VEE from the negative input power supply
J3	1-2*	Connects VCC to the positive power-supply input banana jack
	Open†	Disconnects VCC from the positive input power supply
J4	Open*	Disconnects EP from GND
	1-2	Connects EP to GND

*Indicates default jumper state.

†Connect the power supply through ammeter to monitor supply current.

Table 2. Digital Interface Jumper Settings

JUMPER	SHUNT POSITION	DESCRIPTION
DHV1	1-2*	Connects channel 1 DHV to MAX5734 DAC output
	Open	Disconnects channel 1 DHV from MAX5734 DAC output
DLV1	1-2*	Connects channel 1 DLV to MAX5734 DAC output
	Open	Disconnects channel 1 DLV from MAX5734 DAC output
DTV1	1-2*	Connects channel 1 DTV to MAX5734 DAC output
	Open	Disconnects channel 1 DTV from MAX5734 DAC output
CHV1	1-2*	Connects channel 1 CHV to MAX5734 DAC output
	Open	Disconnects channel 1 CHV from MAX5734 DAC output
CLV1	1-2*	Connects channel 1 CLV to MAX5734 DAC output
	Open	Disconnects channel 1 CLV from MAX5734 DAC output
LDV1	1-2*	Connects channel 1 LDV to MAX5734 DAC output
	Open	Disconnects channel 1 LDV from MAX5734 DAC output
COMPHI	1-2*	Connects COMPHI to MAX5734 DAC output
	Open	Disconnects COMPHI from MAX5734 DAC output
COMPLO	1-2*	Connects COMPLO to MAX5734 DAC output
	Open	Disconnects COMPLO from MAX5734 DAC output
DHV2	1-2*	Connects channel 2 DHV to MAX5734 DAC output
	Open	Disconnects channel 2 DHV from MAX5734 DAC output
DLV2	1-2*	Connects channel 2 DLV to MAX5734 DAC output
	Open	Disconnects channel 2 DLV from MAX5734 DAC output
DTV2	1-2*	Connects channel 2 DTV to MAX5734 DAC output
	Open	Disconnects channel 2 DTV from MAX5734 DAC output
CHV2	1-2*	Connects channel 2 CHV to MAX5734 DAC output
	Open	Disconnects channel 2 CHV from MAX5734 DAC output
CLV2	1-2*	Connects channel 2 CLV to MAX5734 DAC output
	Open	Disconnects channel 2 CLV from MAX5734 DAC output
LDV2	1-2*	Connects channel 2 LDV to MAX5734 DAC output
	Open	Disconnects channel 2 LDV from MAX5734 DAC output
DHV3	1-2*	Connects channel 3 DHV to MAX5734 DAC output
	Open	Disconnects channel 3 DHV from MAX5734 DAC output
DLV3	1-2*	Connects channel 3 DLV to MAX5734 DAC output
	Open	Disconnects channel 3 DLV from MAX5734 DAC output
DTV3	1-2*	Connects channel 3 DTV to MAX5734 DAC output
	Open	Disconnects channel 3 DTV from MAX5734 DAC output
CHV3	1-2*	Connects channel 3 CHV to MAX5734 DAC output
	Open	Disconnects channel 3 CHV from MAX5734 DAC output
CLV3	1-2*	Connects channel 3 CLV to MAX5734 DAC output
	Open	Disconnects channel 3 CLV from MAX5734 DAC output

Table 2. Digital Interface Jumper Settings (continued)

JUMPER	SHUNT POSITION	DESCRIPTION
LDV3	1-2*	Connects channel 3 LDV to MAX5734 DAC output
	Open	Disconnects channel 3 LDV from MAX5734 DAC output
DHV4	1-2*	Connects channel 4 DHV to MAX5734 DAC output
	Open	Disconnects channel 4 DHV from MAX5734 DAC output
DLV4	1-2*	Connects channel 4 DLV to MAX5734 DAC output
	Open	Disconnects channel 4 DLV from MAX5734 DAC output
DTV4	1-2*	Connects channel 4 DTV to MAX5734 DAC output
	Open	Disconnects channel 4 DTV from MAX5734 DAC output
CHV4	1-2*	Connects channel 4 CHV to MAX5734 DAC output
	Open	Disconnects channel 4 CHV from MAX5734 DAC output
CLV4	1-2*	Connects channel 4 CLV to MAX5734 DAC output
	Open	Disconnects channel 4 CLV from MAX5734 DAC output
LDV4	1-2*	Connects channel 4 LDV to MAX5734 DAC output
	Open	Disconnects channel 4 LDV from MAX5734 DAC output

*Indicates default jumper state.

Table 3. Test Points and Their Functions

TEST POINT	DESCRIPTION
RSTB	Active-Low Serial-Port Reset Input
LOADB	Active-Low Serial-Port Load Input
CSB	Active-Low Serial-Port Chip-Select Input for MAX9972
SCLK	Serial-Port Clock Input
DIN	Serial-Port Data Input
DOUT	Serial-Port Data Output
CS_DAC	Active-Low Serial-Port Chip-Select Input for MAX5734 32-Channel DAC
DSP	Digital Serial-Interface Select Input
TEMP	Temperature Sensor Output
SENSE1	Channel 1 PMU Sense Connection
FORCE1	Channel 1 PMU Force Connection
PMU1	Channel 1 Parametric Measurement Connection
SENSE2	Channel 2 PMU Sense Connection
FORCE2	Channel 2 PMU Force Connection
PMU2	Channel 2 Parametric Measurement Connection
SENSE3	Channel 3 PMU Sense Connection
FORCE3	Channel 3 PMU Force Connection
PMU3	Channel 3 Parametric Measurement Connection
SENSE4	Channel 4 PMU Sense Connection
FORCE4	Channel 4 PMU Force Connection
PMU4	Channel 4 Parametric Measurement Connection

Ordering Information

PART	TYPE
MAX9972EVKIT#	EV Kit

#Denotes RoHS compliance.

MAX9972 EV Kit Bill of Materials

ITEM	REF_DES	QTY	MFG PART #	MANUFACTURER	VALUE	DESCRIPTION
1	C1-C17	17	C1608C0G1H103J080AA; CGA3E2C0G1H103J080AD; GRM1885C1H103JA01	TDK; TDK; MURATA	0.01UF	CAP; SMT (0603); 0.01UF; 5%; 50V; C0G; CERAMIC
2	C18, C21, C23-C25, C27	6	GCM188R71H104KA12; GCM188R71H104K; CGA3E2X7R1H104K080AA; CGA3E2X7R1H104K080AD; CL10B104KB8WPN	MURATA; MURATA; TDK; TDK; SAMSUNG	0.1UF	CAP; SMT (0603); 0.1UF; 10%; 50V; X7R; CERAMIC
3	C19, C20, C26, C29-C32	7	UMK107BJ105KA; C1608X5R1H105K080AB; CL10A105KB8NNN; GRM188R61H105KAAL	TAIYO YUDEN; TDK; SAMSUNG; MURATA	1UF	CAP; SMT (0603); 1UF; 10%; 50V; X5R; CERAMIC
4	C22, C28	2	C1608X5R1E106M080AC; CL10A106MA8NRNC; GRM188R61E106MA73; ZRB18AR61E106ME01; GRT188R61E106ME13	TDK; SAMSUNG ELECTRONICS; MURATA;; MURATA	10UF	CAP; SMT (0603); 10UF; 20%; 25V; X5R; CERAMIC
5	CHV1-CHV4, CLV1-CLV4, COMP1, COMPLO, DHV1-DHV4, DLV1-DLV4, DTV1-DTV4, J2-J4, LDV1-LDV4	29	PEC02SAAN	SULLINS	PEC02SAAN	CONNECTOR; MALE; THROUGH HOLE; BREAKAWAY; STRAIGHT; 2PINS
6	CMPH1-CMPH4, CMPL1-CMPL4, DATA1-DATA4, DUT1-DUT4, RCV1-RCV4	20	142-0701-851	JOHNSON COMPONENTS	142-0701-851	CONNECTOR; END LAUNCH JACK RECEPTACLE; BOARDMOUNT; STRAIGHT THROUGH; 2PINS;
7	GND, VCC, VEE	3	3267	POMONA ELECTRONICS	3267	CONNECTOR; MALE; PANELMOUNT; STANDARD UNINSULATED BANANA JACK; STRAIGHT; 1PIN
8	GND2	1	5012	KEYSTONE	N/A	TEST POINT; PIN DIA=0.125IN; TOTAL LENGTH=0.445IN; BOARD HOLE=0.063IN; WHITE; PHOSPHOR BRONZE WIRE SILVER PLATE FINISH;
9	J1	1	PEC10DAAN	SULLINS ELECTRONICS CORP	PEC10DAAN	CONNECTOR; MALE; THROUGH HOLE; BREAKAWAY; STRAIGHT; 20PINS
10	J16, J51	2	PBC10SAAN	SULLINS ELECTRONICS CORP	PBC10SAAN	CONNECTOR; MALE; THROUGH HOLE; BREAKAWAY; STRAIGHT; 10PINS; -65 DEGC TO +125 DEGC

MAX9972 EV Kit Schematic Diagrams (continued)

ITEM	REF_DES		QTY	MFG PART #	MANUFACTURER	VALUE	DESCRIPTION
11	L2, L3		2	DFE252012F-100M	MURATA	10UH	INDUCTOR; SMT (1008); SHIELDED; 10UH; 20%; 0.95A
12	MH1-MH4		4	9032	KEYSTONE	9032	MACHINE FABRICATED; ROUND-THRU HOLE SPACER; NO THREAD; M3.5; 5/8IN; NYLON
13	R1		1	CRCW06031M69FK	VISHAY DALE	1.69M	RES; SMT (0603); 1.69M; 1%; +/-100PPM/DEGK; 0.1000W
14	R2		1	CRCW06031M20FK	VISHAY DALE	1.2M	RES; SMT (0603); 1.2M; 1%; +/-100PPM/DEGC; 0.1000W
15	R8		1	CRCW06031K00FK; ERJ-3EKF1001; CR0603AFX-1001ELF	VISHAY; PANASONIC; BOURNS	1K	RES; SMT (0603); 1K; 1%; +/-100PPM/DEGC; 0.1000W
16	R9		1	CRCW06030000ZS; MCR03EZPJ000; ERJ-3GEY0R00; CR0603AJJ-000ELF	VISHAY; ROHM SEMICONDUCTOR; PANASONIC;BOURNS	0	RES; SMT (0603); 0; JUMPER; JUMPER; 0.1000W
17	U1		1	MAX40026ATA+	MAXIM	MAX40026ATA+	IC; COMP; 280PS HIGH-SPEED COMPARATOR; ULTRA-LOWDISPERSION WITH LVDS OUTPUTS; TDFN8-EP
18	U2		1	MAX32625PICO	MAXIM	MAX32625PICO	MODULE; BOARD; MAX32625PICO BOARD DESIGN FOR MAX32625 ARM CORTEX-M4F; BOARD; LAMINATED PLASTIC WITH COPPER CLAD;
19	U3		1	MAX1735EUK30+	MAXIM	MAX1735EUK30+	IC; VREG; NEGATIVE-OUTPUT LOW-DROPOUT LINEAR REGULATOR; SOT23-5
20	U4, U8		2	MAX1726EUK50+	MAXIM	MAX1726EUK50+	IC; VREG; ULTRA-LOW IQ LOW-DROPOUT LINEAR REGULATOR; SOT23-5
21	U5		1	MAX1725EUK+	MAXIM	MAX1725EUK+	IC; REG; 12V; ULTRA-LOW IQ; LOW-DROPOUT LINEAR REGULATOR; SOT23-5
22	U6		1	MAX5734AUTN+	MAXIM	MAX5734AUTN+	IC; DAC; 32-CHANNEL; 16-BIT; +/-8 MAX INL; VOLTAGE-OUTPUT DAC WITH SERIAL INTERFACE; TQFN56-EP 8X8
23	U7		1	MAX6126AASA30+	MAXIM	MAX6126AASA30+	IC; VREF; VOLTAGE REFERENCE; NSOIC8
24	U9		1	MAX9972ACCS+	MAXIM	MAX9972ACCS+	IC; DRV; QUAD ULTRA-LOW-POWER 300MBPS ATE DRIVER/COMPARATOR; TQFP80-EP 12X12
25	Z1		1	10-6327-01G	AAVID	10-6327-01G	MACHINE FABRICATED; Q-PUSHPIN; 28.5MMX28.5MMX10MM; BGA SPRING TYPE; BLACK ANNOXIDIZED ALUMINUM
26	PCB		1	MAX9972	MAXIM	PCB	PCB:MAX9972
27	MISC1	DNI	1	3025010-03	QUALTEK ELECTRONICS CORP	3025010-03	CONNECTOR; MALE; USB-A_MINI-B; USB 4P(A)/M - USB MINI 5P(B)/M; STRAIGHT; 36IN
TOTAL			110				

MAX9972 EV Kit Schematic Diagrams

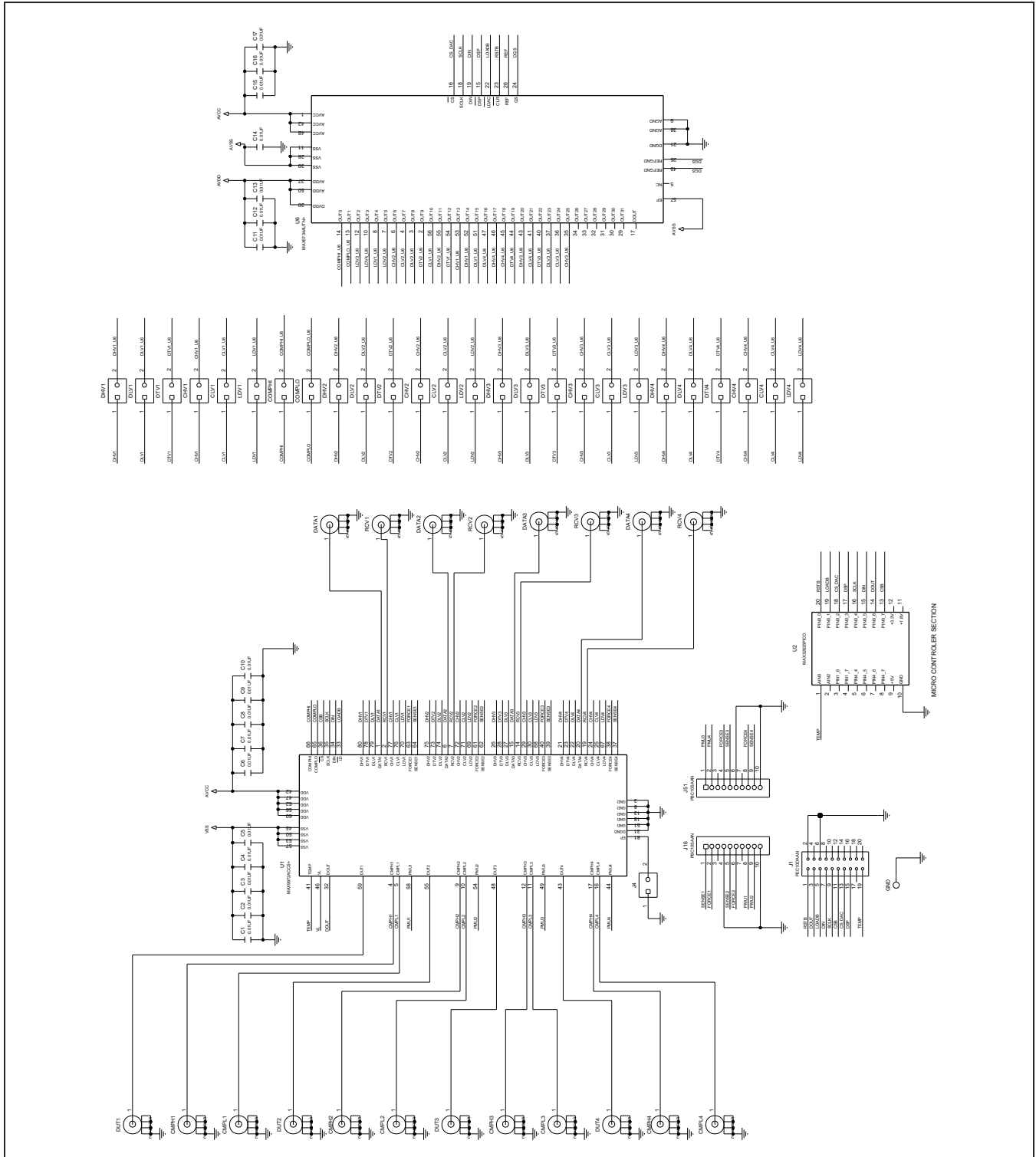

MAX9972 EV Kit Schematic Diagrams (continued)

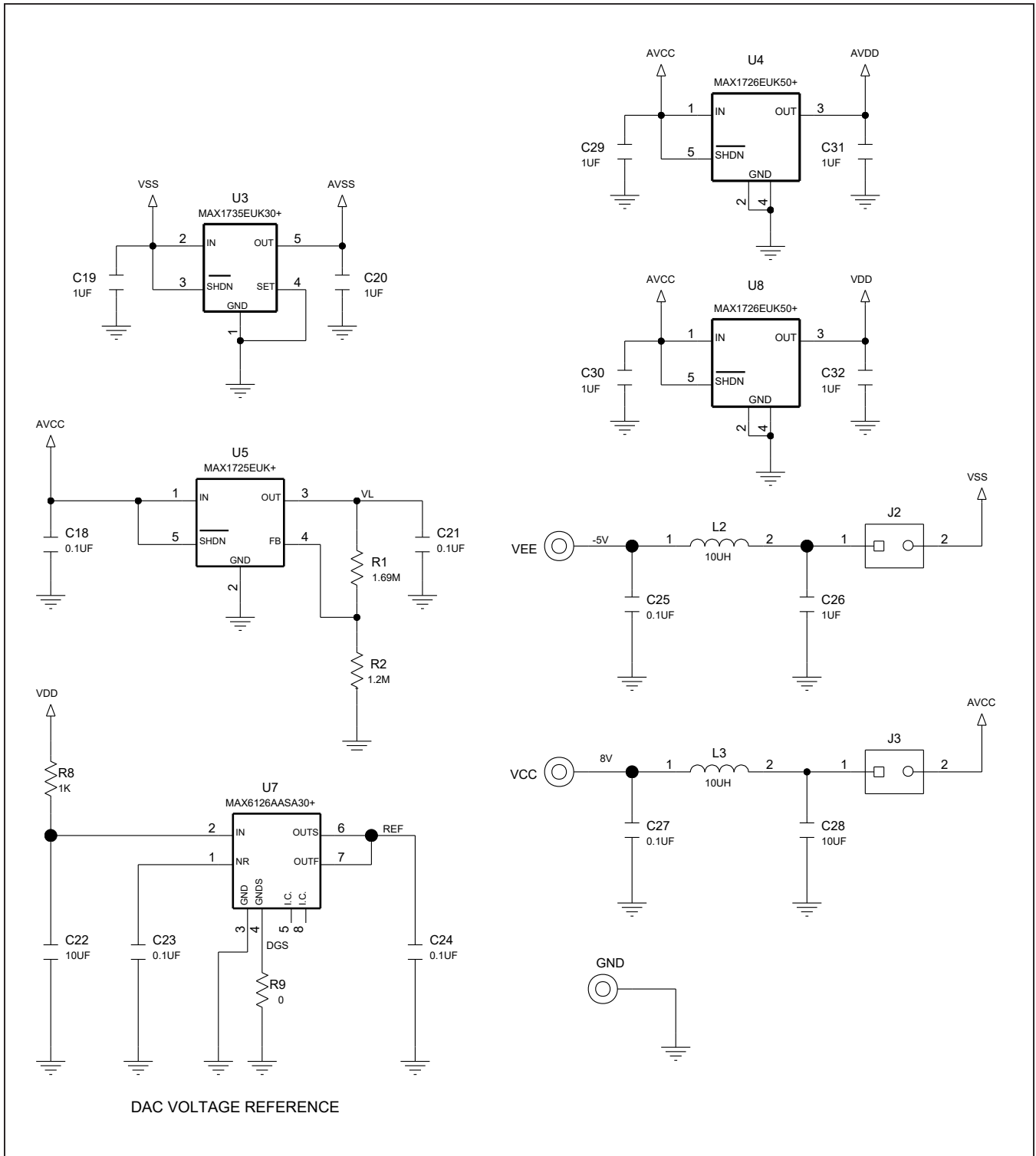

MAX9972 EV Kit PCB Layout Diagrams

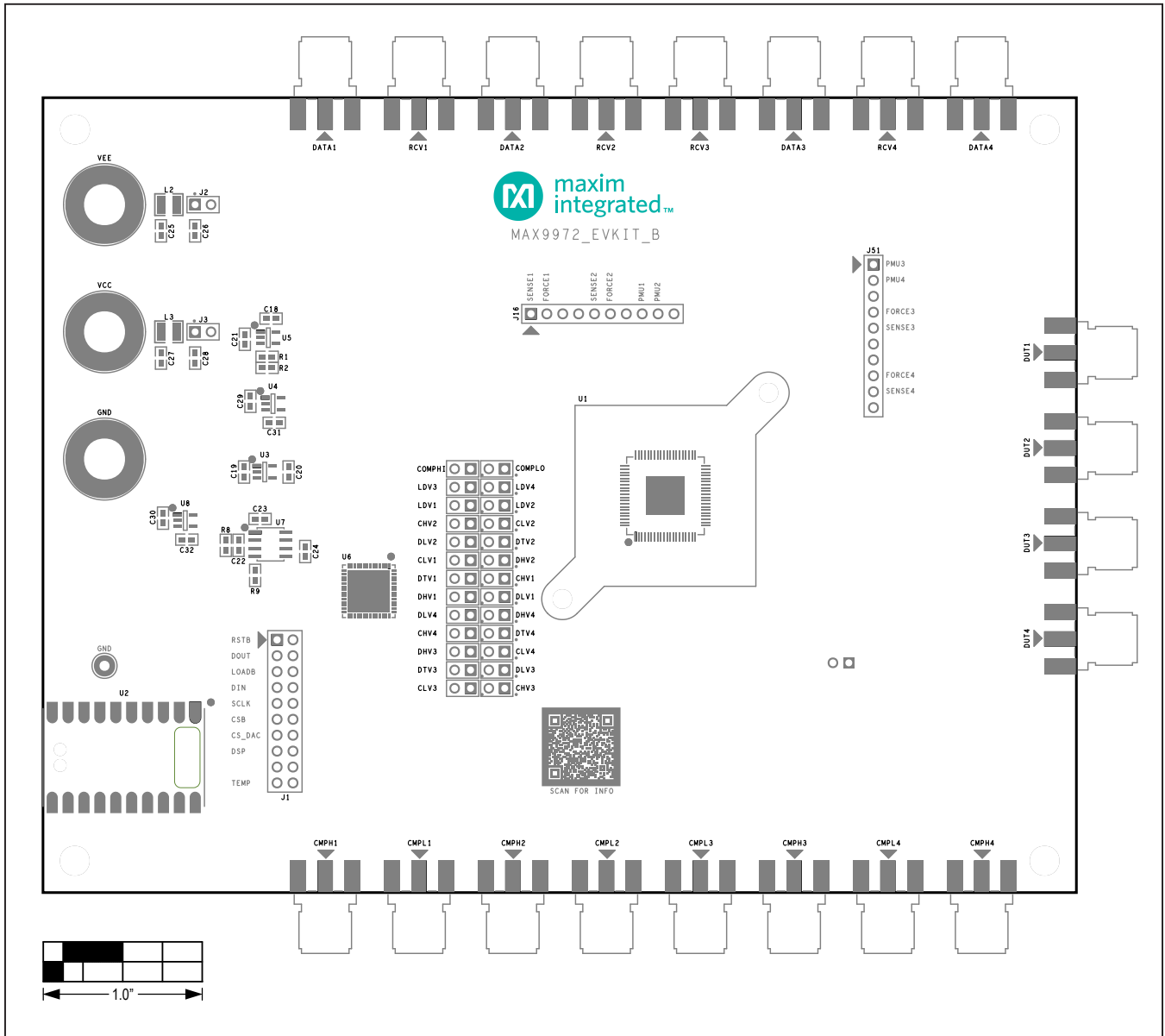

MAX9972 EV Kit PCB Layout—Top Silkscreen

MAX9972 EV Kit PCB Layout Diagrams (continued)

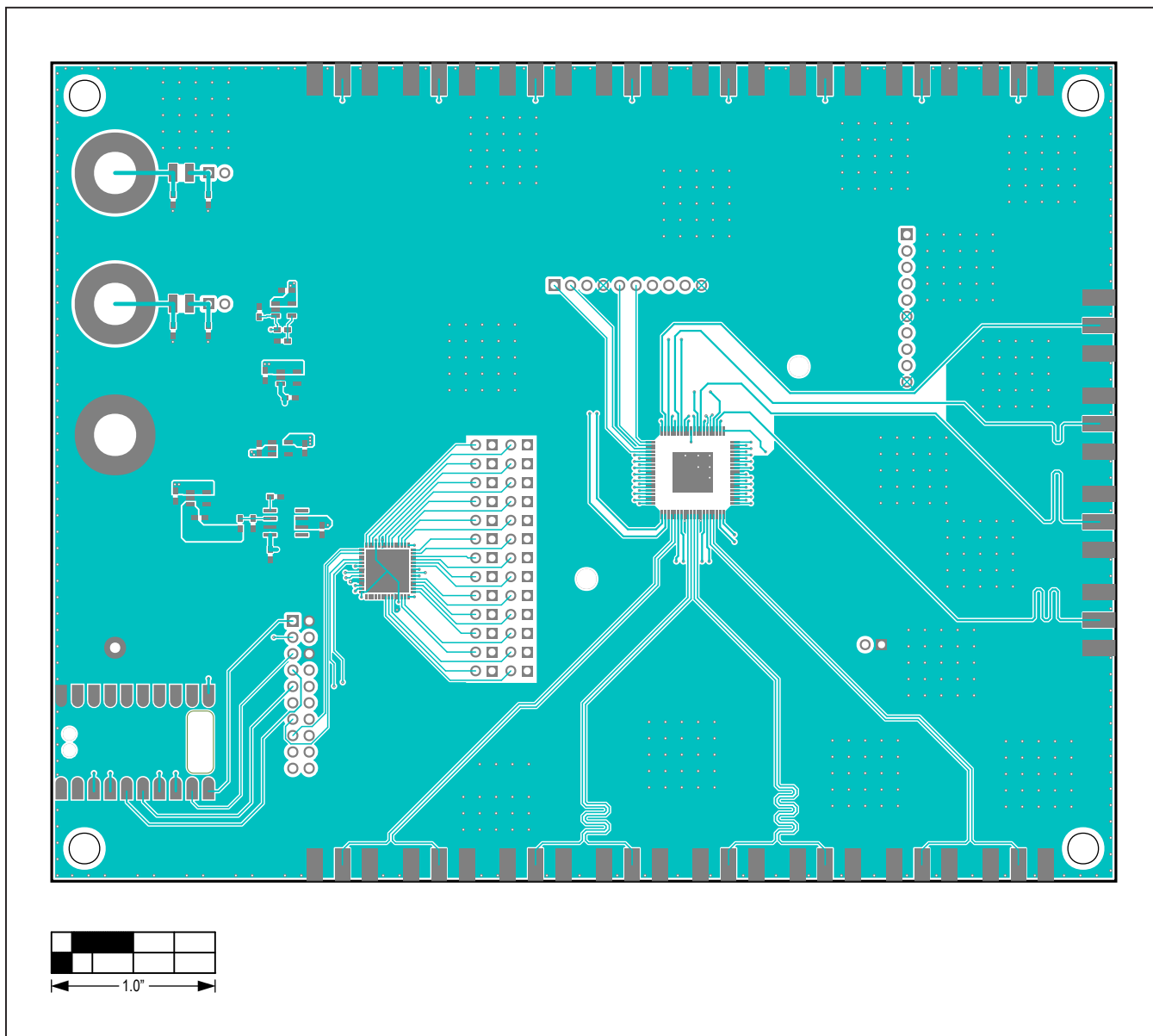

MAX9972 EV Kit PCB Layout—Top View

MAX9972 EV Kit PCB Layout Diagrams (continued)

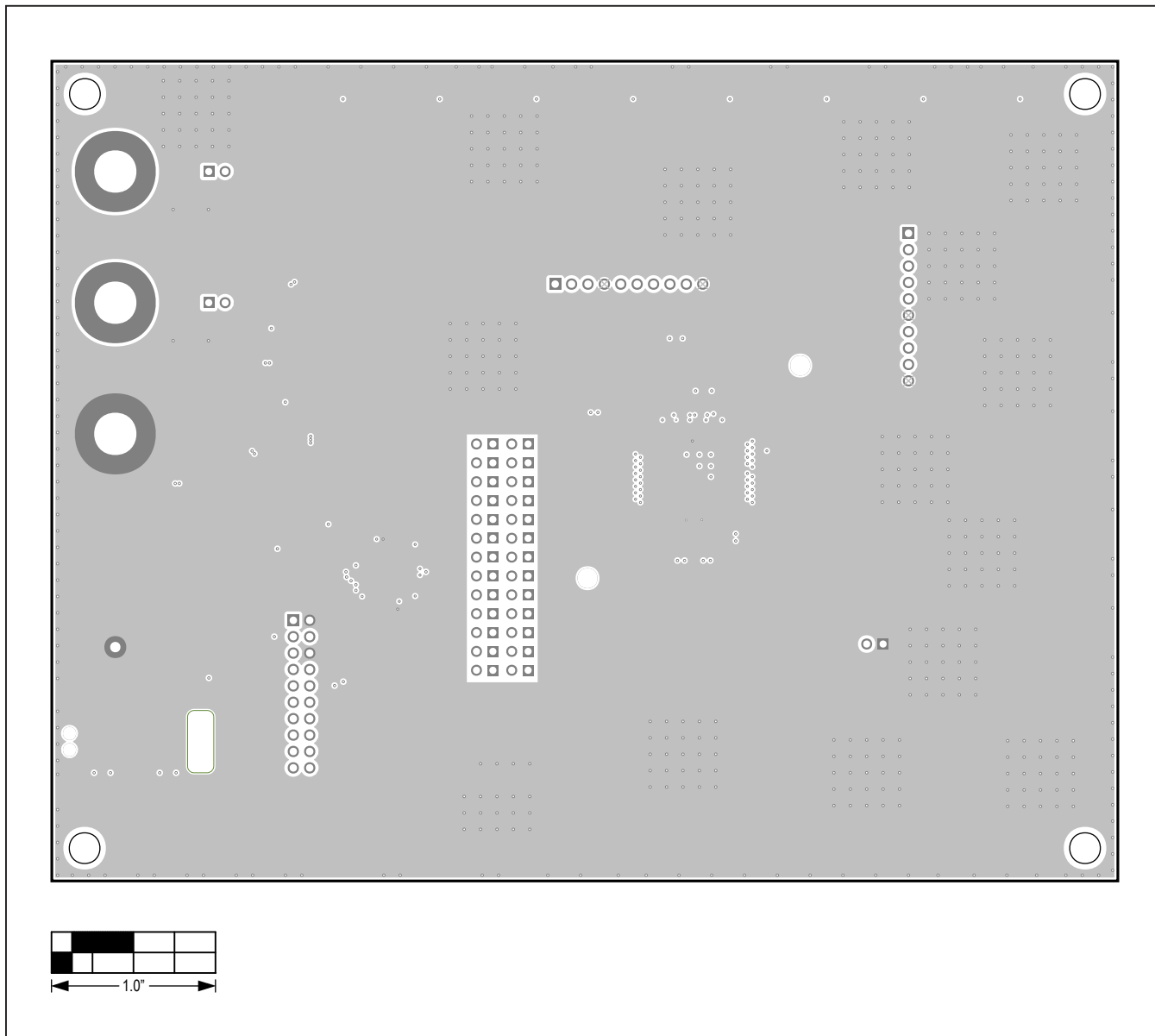

MAX9972 EV Kit PCB Layout—Internal 2 (Ground)

MAX9972 EV Kit PCB Layout Diagrams (continued)

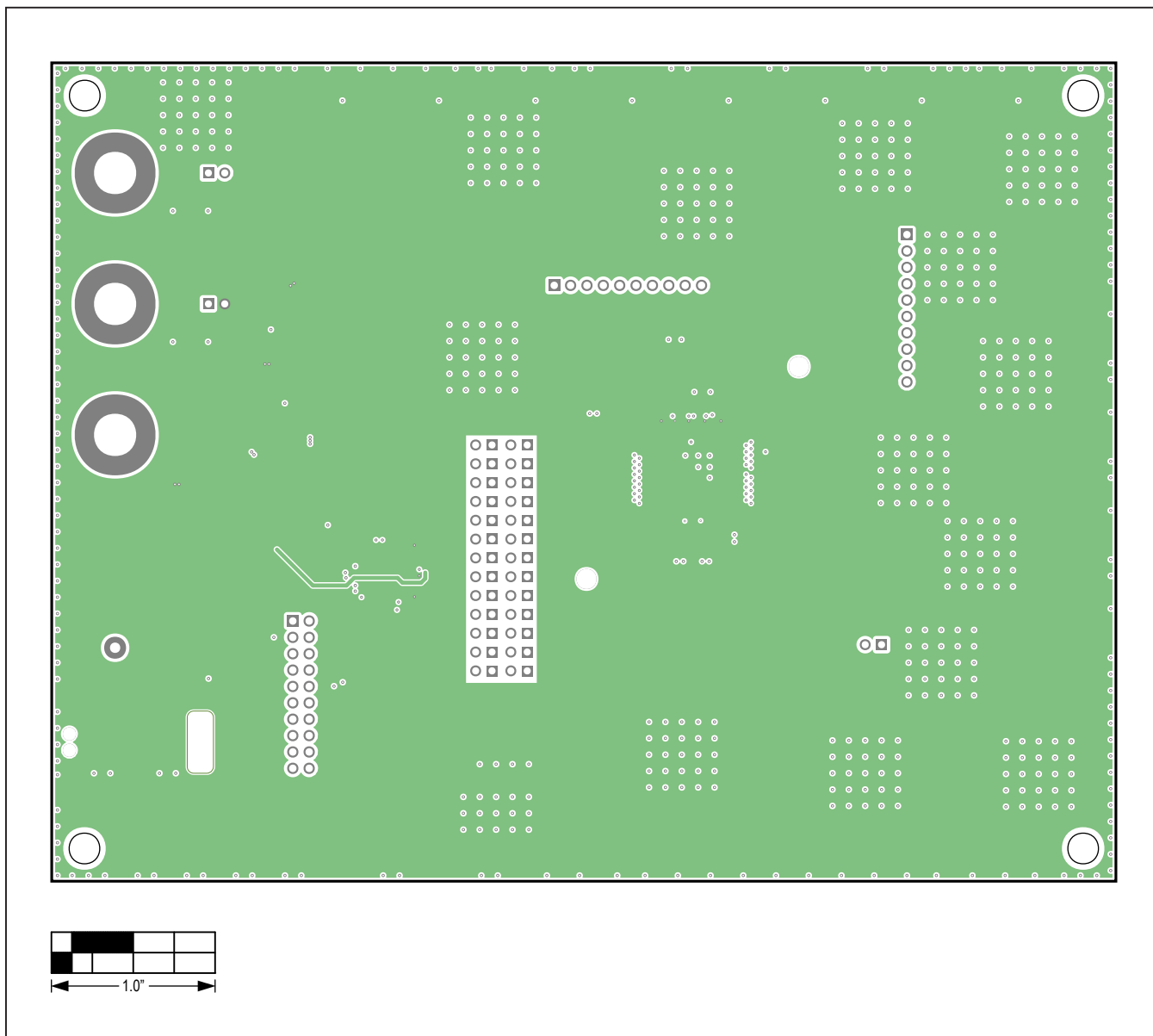

MAX9972 EV Kit PCB Layout—Internal 3 (VCC)

MAX9972 EV Kit PCB Layout Diagrams (continued)

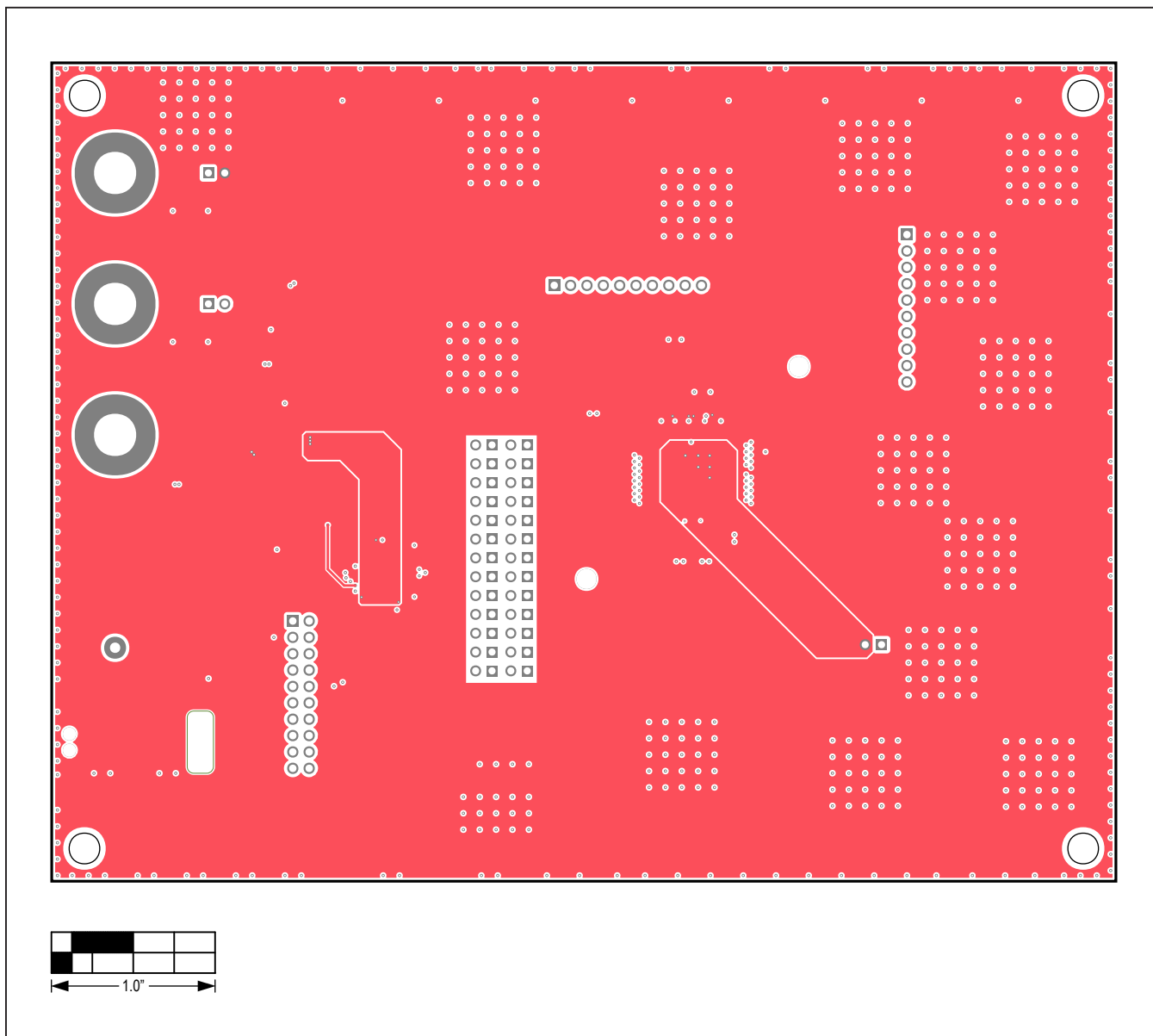

MAX9972 EV Kit PCB Layout—Internal 4 (VEE)

MAX9972 EV Kit PCB Layout Diagrams (continued)

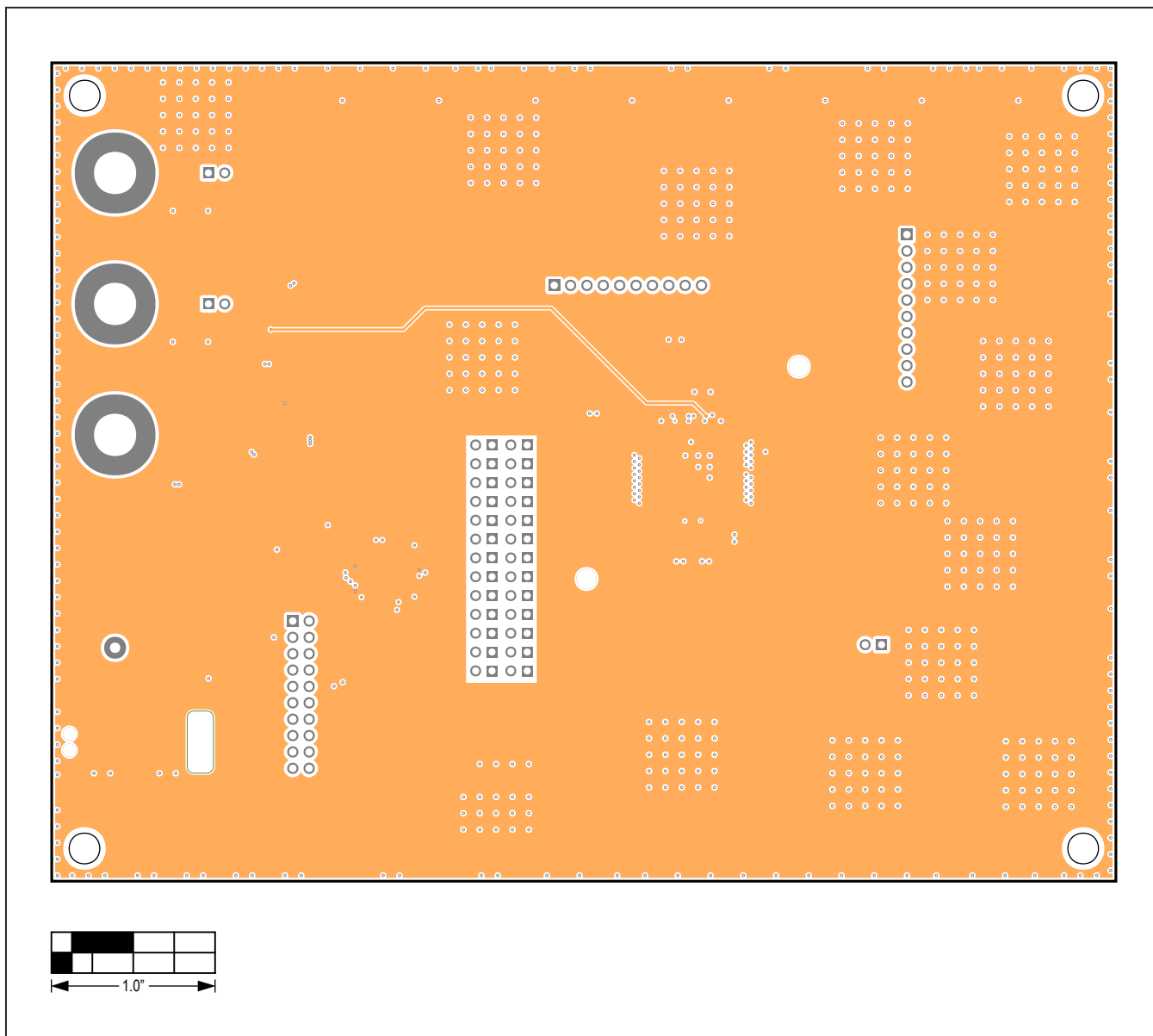

MAX9972 EV Kit PCB Layout—Internal 5 (VDD)

MAX9972 EV Kit PCB Layout Diagrams (continued)

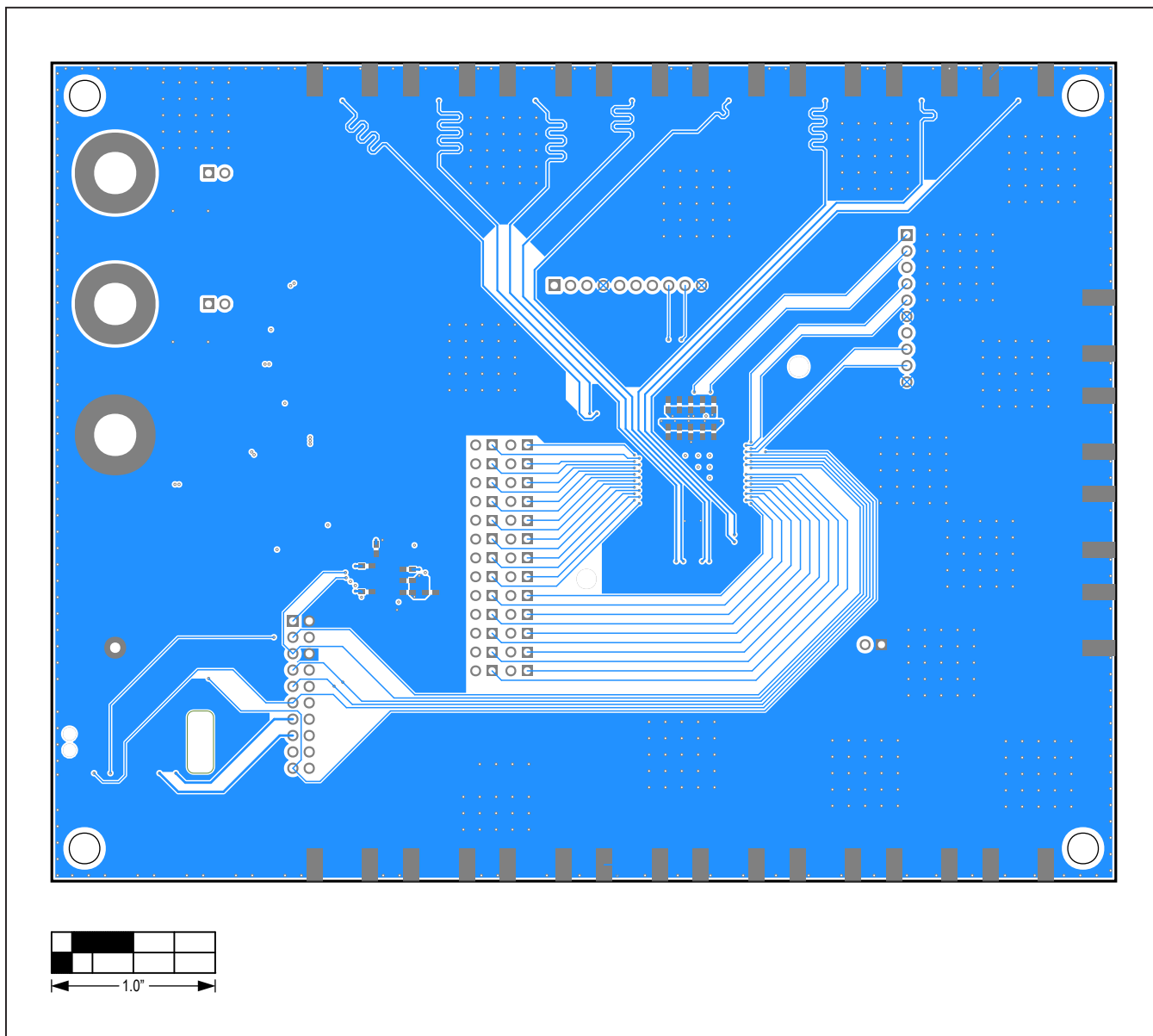

MAX9972 EV Kit PCB Layout—Bottom View

MAX9972 EV Kit PCB Layout Diagrams (continued)

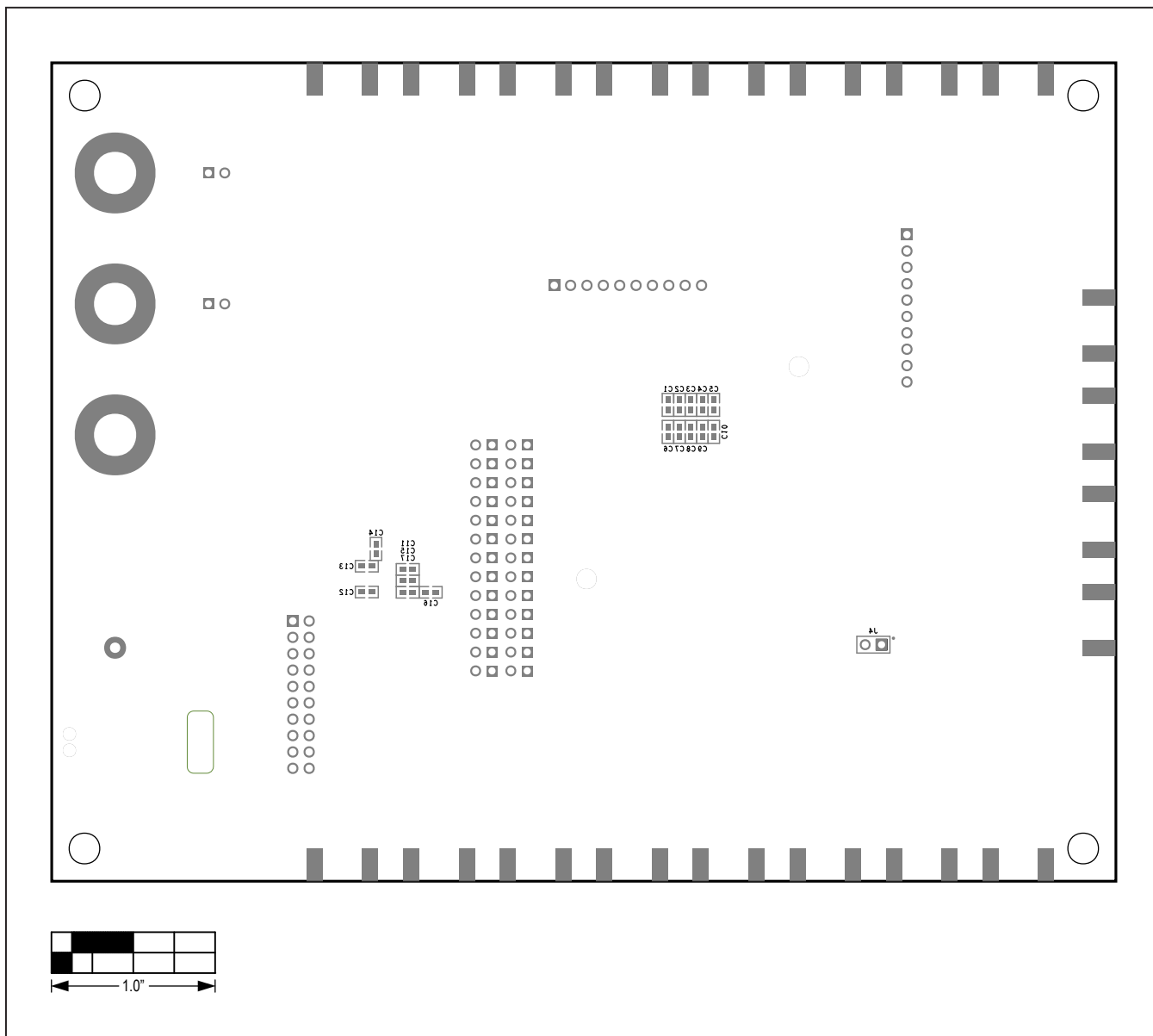

MAX9972 EV Kit PCB Layout—Silkscreen Bottom