

MAXM17712/MAXM17720/ MAXM17724 Evaluation Kit

Evaluates: MAXM17712/MAXM17720/ MAXM17724 Modules Application

General Description

The MAXM17712/MAXM17720/MAXM17724 evaluation kits (EV kit) provide a proven design to evaluate the performance of MAXM17712/MAXM17720/MAXM17724 modules. Each of these modules operates over a wide input range from 5.5V to 60V, and features an integrated 150mA step-down converter and 50mA linear regulator. The modules are configured to demonstrate optimum performance and component sizes in this EV kit.

MAXM17712 delivers up to 150mA from the 3.3V fixed output step-down converter, and up to 50mA from the 1.8V fixed output linear regulator. The step-down converter is configured to operate at 375kHz switching frequency, over a 5.5V to 60V input range.

MAXM17720 delivers up to 150mA from the 5V fixed output step-down converter, and up to 50mA from the 3.3V fixed output linear regulator. The step-down converter is configured to operate at 570kHz switching frequency, over an 8.4V to 60V input range.

MAXM17724 is configured to deliver up to 150mA from the adjustable output step-down converter programmed to 5V, and up to 50mA from the 2.5V fixed output linear regulator. The step-down converter is configured to operate at 570kHz switching frequency, over an 8.4V to 60V input range.

The EV kits feature provisions for selecting mode of operation (PWM or PFM), synchronization to an external clock source, enable/disable, and UVLO settings. The MAXM17710–MAXM17726 module family data sheet provides a complete description of the parts and should be read in conjunction with this data sheet prior to operating the EV kits.

Features

- Wide 5.5V to 60V Input Range
- MAXM17712 Offers High 82% Efficiency ($V_{IN} = 24V$, $V_{OUTB} = 3.3V$, $I_{OUTB} = 75mA$)
- MAXM17720 Offers High 85% Efficiency ($V_{IN} = 24V$, $V_{OUTB} = 5V$, $I_{OUTB} = 75mA$)
- MAXM17724 Offers High 85% Efficiency ($V_{IN} = 24V$, $V_{OUTB} = 5V$, $I_{OUTB} = 75mA$)
- Enable/UVLO Input, Resistor-Programmable UVLO Threshold
- Selectable PWM and PFM Modes of Operation
- Provision to Synchronize the Step-Down Converters to External-Clock Source
- Low-Profile, Surface-Mount Components
- Proven PCB Layout
- Fully Assembled and Tested
- \overline{RESET} Outputs, with Pullup Resistor to Respective Output Voltages
- Complies with CISPR22(EN55022) Class B Conducted and Radiated Emissions

Ordering Information appears at end of data sheet.

MAXM17712/MAXM17720/ MAXM17724 Evaluation Kit

Evaluates: MAXM17712/MAXM17720/ MAXM17724 Modules Application

Quick Start

Required Equipment

- One 60V DC power supply
- Digital multimeters (DMM)
- Load resistor for step-down converter capable of sinking 150mA
- Load resistor for linear regulator capable of sinking 50mA

Equipment Setup and Procedure

The EV kits are fully assembled and tested. Follow the steps below to verify and test an individual module's operation.

Caution: Do not turn on power supply until all connections are completed.

- 1) Set the input power supply at a voltage between 5.5V and 60V (for MAXM17712), or between 8.4V and 60V (for MAXM17720 and MAXM17724). Disable the power supply.
- 2) Connect the positive terminal and negative terminal of the power supply to the V_{IN} pad and its adjacent GND pad of the module under evaluation.
- 3) Connect a maximum of 50mA resistive load across OUTL pad and its adjacent GND pad of the corresponding module.
- 4) Connect a maximum of 150mA resistive load across OUTB pad and its adjacent GND pad of the corresponding module. Note that the step-down converter powers the linear regulator. Ensure that the total load on step-down converter does not exceed 150mA.
- 5) Verify that the shunts are not installed on jumpers (JU11, JU21, JU31) (see [Table 1](#) for details).
- 6) Select the shunt position on respective jumpers (JU12, JU22, JU32) according to the required mode of operation (see [Table 2](#) for details).
- 7) Connect digital multimeters (in voltage measurement mode) across the OUTB, OUTL and their respective GND pads.
- 8) Turn on the input power supply.
- 9) Verify that the DMMs display expected terminal voltages with respect to GND.

Detailed Description

The MAXM17712/MAXM17720/MAXM17724 EV kits are designed to demonstrate the salient features of the MAXM17712/MAXM17720/MAXM17724 power modules. The EV kits consist of typical application circuits of three different modules. Each of these circuits are electrically isolated from each other and hosted on the same PCB. Each of the modules can be evaluated by powering them from their respective input pins. Individual module settings can be adjusted to evaluate the performance under different operating conditions.

Setting Switching Frequency

Selection of switching frequency must consider input voltage range, desired output voltage, $t_{ON(MIN)}$ and $t_{OFF(MIN)}$ of the step-down converters. Resistors R15, R25, and R35 on the EV kits program the desired switching frequencies of the step-down converters. To optimize performance and component size, 375kHz switching frequency is chosen for the step-down converter in MAXM17712, and 570kHz is chosen for MAXM17720 and MAXM17724 step-down converters. Use [Table 1](#) and [Switching Frequency](#) section of MAXM17710-MAXM17726 data sheet to choose different values of resistors for programming the required switching frequency.

Enable/Undervoltage Lockout (EN/UVLO) Programming

The MAXM17712/MAXM17720/MAXM17724 offer an adjustable input undervoltage lockout level for the step-down converter. In the EV kits, for normal operation, leave the jumpers (JU11, JU21, JU31) open. When jumper JU11 is left open, MAXM17712 is enabled when the input voltage rises above 5.5V. When jumpers JU21 and JU31 are left open, MAXM17720 and MAXM17724 modules are enabled when the input voltage rises above 8.4V. To disable the modules, install shunts across pins 1-2 on jumpers (JU11, JU21, JU31). See [Table 1](#) for jumpers (JU11, JU21, JU31) settings.

A potential divider formed by the resistors R_{UPPER} (R11, R21, R31) and R_{LOWER} (R12, R22, R32) sets the input voltage (V_{INU}) at which the module is enabled.

Choose R_{UPPER} (R11, R21, R31) to be 3.32M Ω and then calculate R_{LOWER} (R12, R22, R32) as follows:

$$R_{LOWER} = \frac{R_{UPPER} \times 1.215}{(V_{INU} - 1.215)}$$

Where R_{LOWER} (R12, R22, R32) in M Ω .

MAXM17712/MAXM17720/ MAXM17724 Evaluation Kit

For MAXM17712 to turn ON at 5.5V input, the resistor R12 is calculated to be 953k Ω .

For MAXM17720 and MAXM17724 to turn ON at 8.4V input, the resistors R22 and R32 are calculated to be 562k Ω .

MODE Selection and External Clock Synchronization

The MAXM17712/MAXM17720/MAXM17724 PFM mode of operation increases operating efficiency at light-load conditions. In the EV kits, leave jumpers (JU12, JU22, JU32) open for operating the parts in PFM mode at light-loads. Install shunts across jumpers (JU12, JU22, JU32), to set the modules to operate in PWM mode. See [Table 2](#) for jumpers (JU12, JU22, JU32) settings.

The internal oscillators of the devices can be synchronized to an external clock signal through the MODE/SYNC pin. The external synchronization clock frequency must be between $1.1 \times f_{SW}$ and $1.4 \times f_{SW}$, where f_{SW} is the frequency programmed by the resistors (R15, R25, R35) connected to the RT pin. The minimum external clock on-time and off-time pulse-widths should be greater than 100ns. Jumpers JU12, JU22, and JU32 must be left unconnected before applying external clock at the MODE/SYNC pins.

Adjusting Output Voltage

The MAXM17724 supports a 2.5V to 5V adjustable output voltage range for the integrated step-down converter. The MAXM17724 default output voltage is preset to 5V. To program a different output voltage, choose R34 less than or equal to 49.9k Ω and calculate R33 with the following equation:

$$R_{33} = R_{34} \times \left[\frac{V_{OUTB}}{0.8} - 1 \right]$$

The minimum step-down converter voltage needed to guarantee regulated linear regulator output voltage is as follows:

$$V_{OUTB} = V_{LDO} + V_{DO}$$

Where V_{DO} is the dropout voltage of the LDO (450mV, as specified in the datasheet).

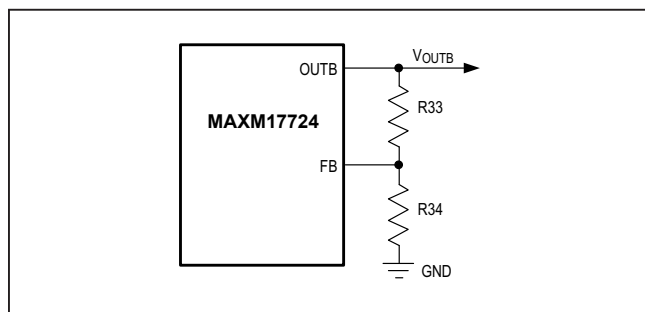

Figure 1. Adjusting Output Voltage of MAXM17724

Evaluates: MAXM17712/MAXM17720/ MAXM17724 Modules Application

The MAXM17724 integrated LDO output voltage is fixed at 2.5V. For guaranteed regulation of linear regulator output voltage, the integrated step-down converter (OUTB) in MAXM17724 should be adjusted to voltage greater than 2.95V.

Input Capacitor Selection

The input capacitors (C13, C23, C33) serve to reduce current peaks drawn from the input power supply and reduce switching frequency ripple at the input. The input capacitance must be greater than or equal to the value given in *Table 1* of *MAXM17710-MAXM17726 data sheet*. Input capacitors (C13, C23, C33) are chosen to be 1 μ F/100V.

Output Capacitor Selection

X7R ceramic output capacitors are preferred due to their stability over temperature in industrial applications. The required output capacitors (C15, C25, C35) for 3.3V and 5V outputs are selected from *Table 1* of *MAXM17710-MAXM17726 data sheet* as 10 μ F/10V.

Electromagnetic Interference (EMI)

Compliance with conducted emissions (CE) standards requires an EMI filter at the input of a switching power converter. The EMI filter attenuates high-frequency currents drawn by the switching power converter, and limits the noise injected back into the input power source.

Use of EMI filter components as shown in [Figure 2](#) in conjunction with the schematic results in lower conducted emissions, below CISPR22 Class B limits. Manufacturer part numbers of the EMI filter components are listed as optional BOM. The MAXM17712/MAXM17720/MAXM17724 EV kits PCB layout is also designed to limit radiated emissions from switching nodes of the power converter, resulting in radiated emissions below CISPR22 Class B limits. Further, capacitors (C14, C24, C34, 0.1 μ F/100V), placed near the modules, help in attenuating high frequency noise.

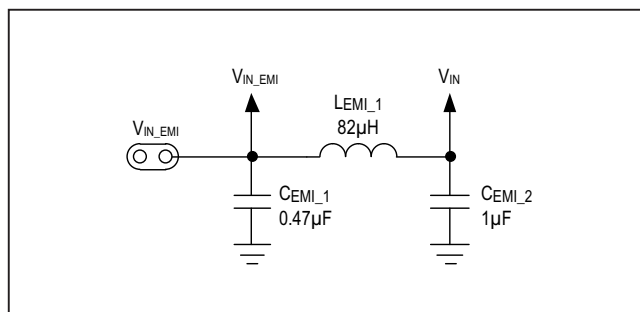

Figure 2. EMI Filter Components

Hot Plug-In and Long Input Cables

The MAXM17712/MAXM17720/MAXM17724 EV kits PCB provides optional electrolytic capacitors (C12, C22, C32 4.7uF/100V) to dampen input voltage peaks and oscillations that can arise during hot-plug-in and/or due to long input cables. These capacitors limit the peak voltage at the input of the power modules, when the EV kit is

powered directly from a pre-charged capacitive source or an industrial backplane PCB. Long input cables, between input power source and the EV kit circuit can cause input-voltage oscillations due to the inductance of the cables. The equivalent series resistance (ESR) of the electrolytic capacitor helps damp out the oscillations caused by long input cables.

Table 1. Step-Down Converter (EN/UVLO) Description (JU11, JU21 and JU31)

SHUNT POSITION	EN/UVLO PIN	OUTPUT
Not installed*	Connected to the center nodes of the respective resistor-dividers (R11 and R12; R21 and R22; R31 and R32)	Programmed to startup at desired input-voltage level
1-2	Connected to GND	Disabled

*Default position.

Table 2. MODE/SYNC Description (JU12, JU22 and JU32)

SHUNT POSITION	MODE/SYNC PIN	MODE
Not installed*	Unconnected	PFM mode of operation
1-2	Connected to GND	PWM mode of operation

*Default position.

MAXM17712/MAXM17720/ MAXM17724 Evaluation Kit

Evaluates: MAXM17712/MAXM17720/ MAXM17724 Modules Application

EV Kit Performance Report

$V_{IN} = 24V$, $T_A = 25^\circ C$, unless otherwise noted.

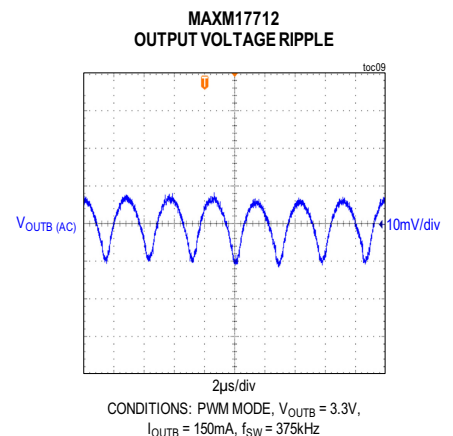
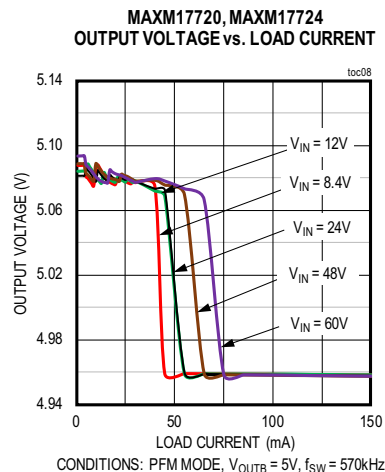
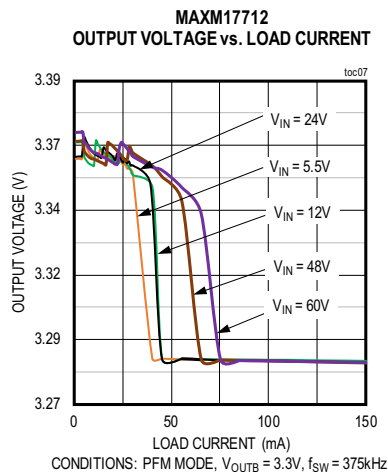
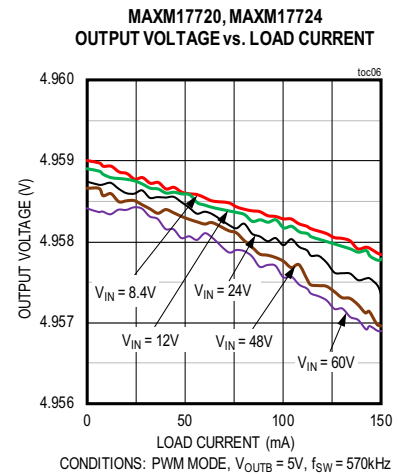
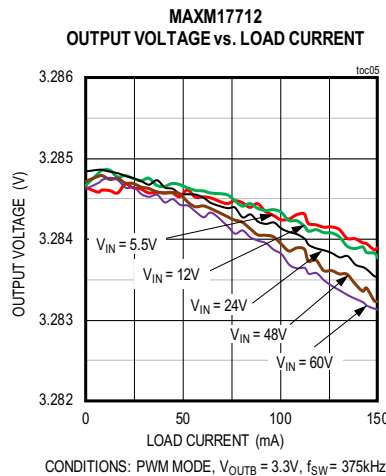
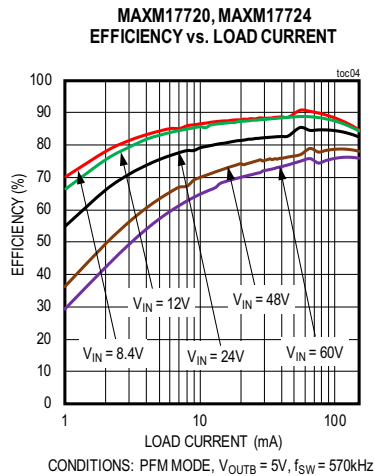
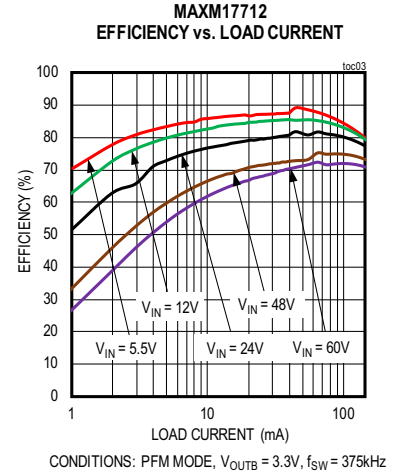
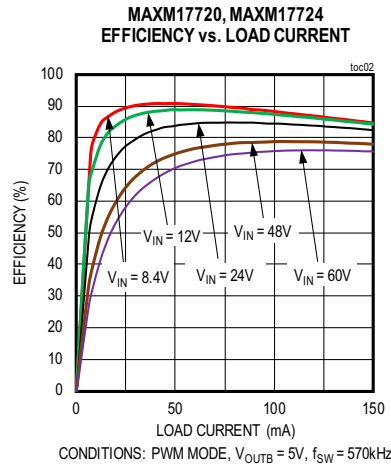
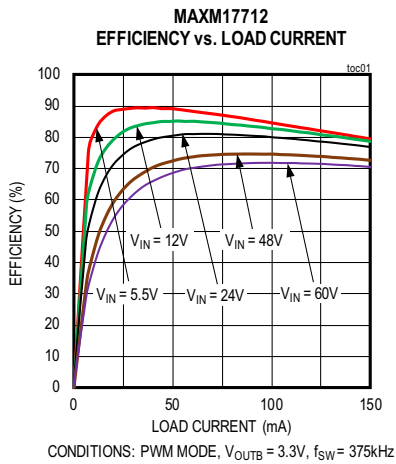

EV Kit Performance Report (continued)

$V_{IN} = 24V$, $T_A = 25^{\circ}C$, unless otherwise noted.

MAXM17720, MAXM17724
OUTPUT VOLTAGE RIPPLE

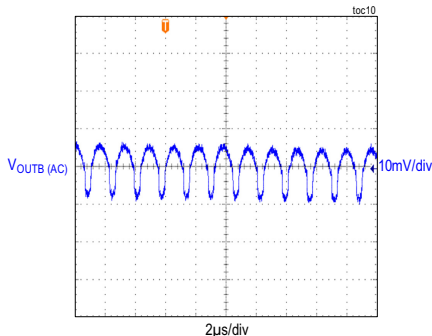

CONDITIONS: PWM MODE, $V_{OUTB} = 5V$,
 $I_{OUTB} = 150mA$, $f_{SW} = 570kHz$

MAXM17712
LOAD TRANSIENT RESPONSE

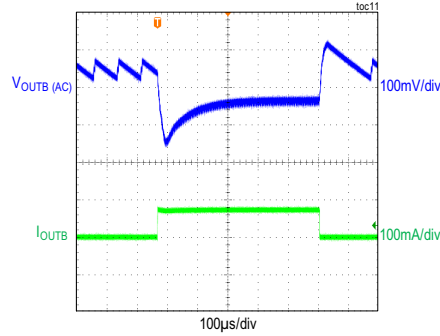

CONDITIONS: PFM MODE, $V_{OUTB} = 3.3V$, $f_{SW} = 375kHz$
LOAD STEP BETWEEN 5mA TO 75mA

MAXM17712
LOAD TRANSIENT RESPONSE

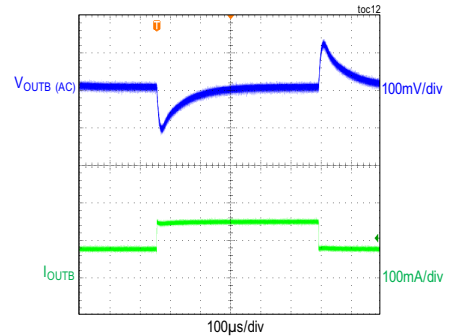

CONDITIONS: PWM MODE, $V_{OUTB} = 3.3V$, $f_{SW} = 375kHz$
LOAD STEP BETWEEN 75mA TO 150mA

MAXM17720, MAXM17724
LOAD TRANSIENT RESPONSE

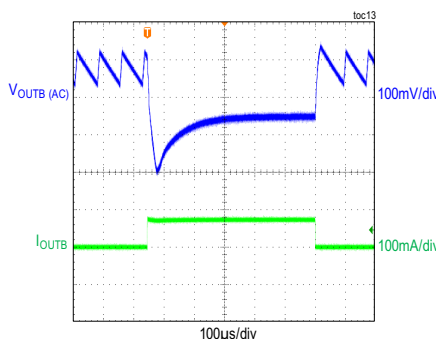

CONDITIONS: PFM MODE, $V_{OUTB} = 5V$, $f_{SW} = 570kHz$
LOAD STEP BETWEEN 5mA TO 75mA

MAXM17720, MAXM17724
LOAD TRANSIENT RESPONSE

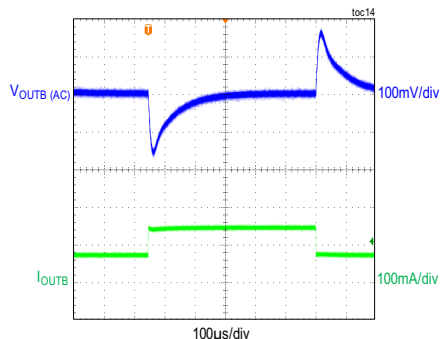

CONDITIONS: PWM MODE, $V_{OUTB} = 5V$, $f_{SW} = 570kHz$
LOAD STEP BETWEEN 75mA TO 150mA

MAXM17712
STARTUP THROUGH ENABLE

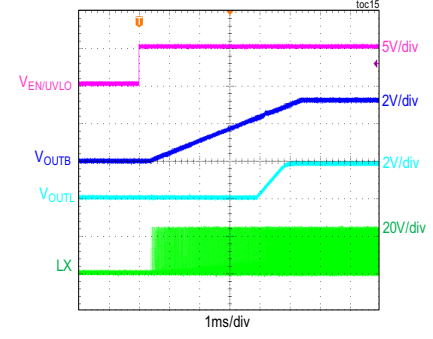

CONDITIONS: PWM MODE, $V_{OUTB} = 3.3V$, $V_{OUTL} = 1.8V$,
 $I_{OUTB} = 100mA$, $I_{OUTL} = 50mA$, $f_{SW} = 375kHz$

MAXM17712
SHUTDOWN THROUGH ENABLE

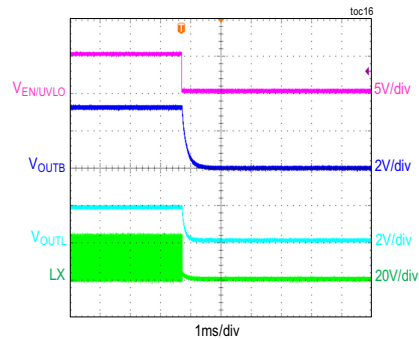

CONDITIONS: PWM MODE, $V_{OUTB} = 3.3V$, $V_{OUTL} = 1.8V$,
 $I_{OUTB} = 100mA$, $I_{OUTL} = 50mA$, $f_{SW} = 375kHz$

MAXM17720
STARTUP THROUGH ENABLE

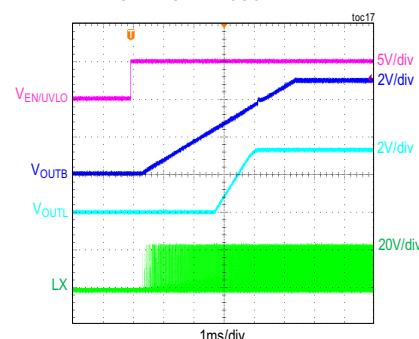

CONDITIONS: PWM MODE, $V_{OUTB} = 5V$, $V_{OUTL} = 3.3V$,
 $I_{OUTB} = 100mA$, $I_{OUTL} = 50mA$, $f_{SW} = 570kHz$

MAXM17720
SHUTDOWN THROUGH ENABLE

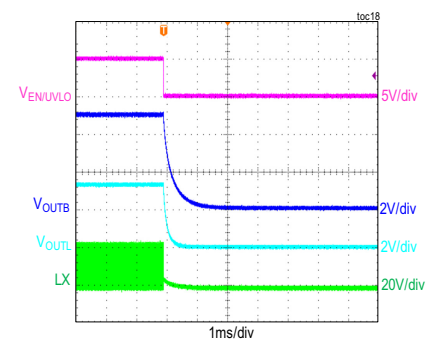

CONDITIONS: PWM MODE, $V_{OUTB} = 5V$, $V_{OUTL} = 3.3V$,
 $I_{OUTB} = 100mA$, $I_{OUTL} = 50mA$, $f_{SW} = 570kHz$

EV Kit Performance Report (continued)

$V_{IN} = 24V$, $T_A = 25^\circ C$, unless otherwise noted.

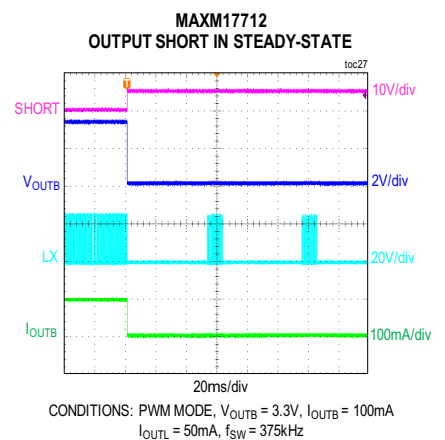
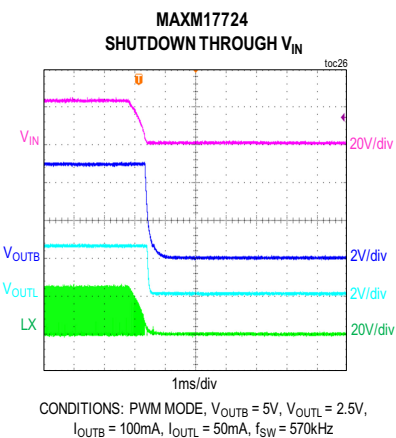
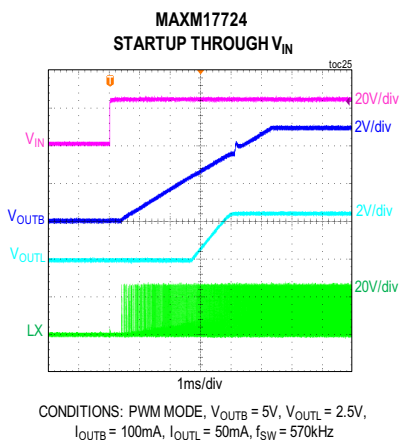
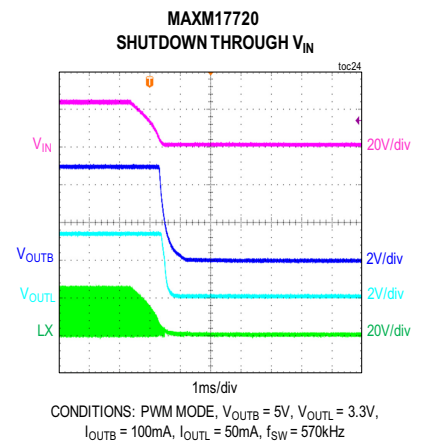
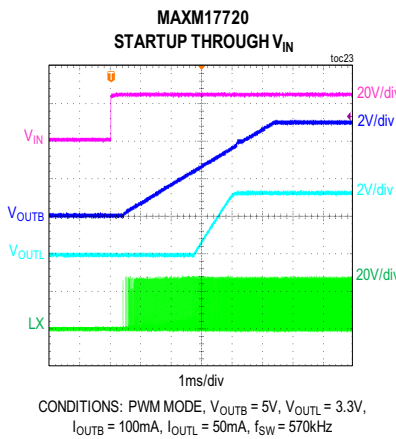
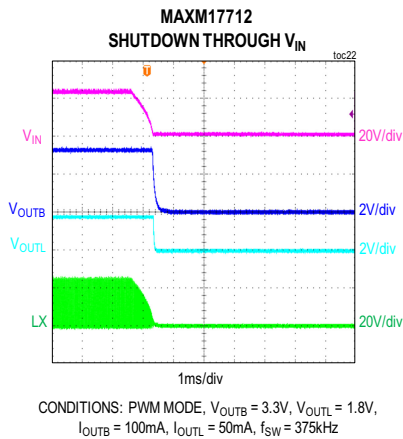
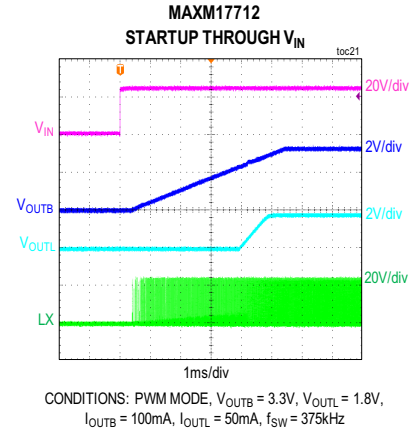
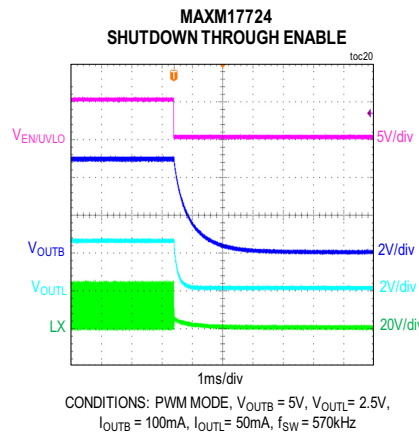
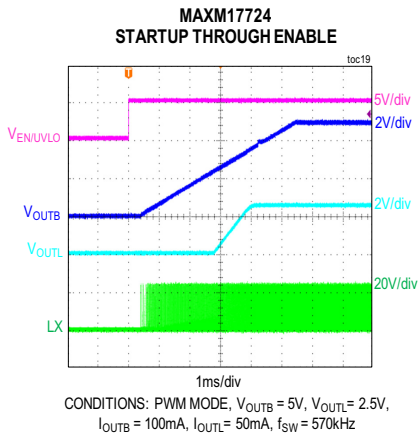

EV Kit Performance Report (continued)

$V_{IN} = 24V$, $T_A = 25^\circ C$, unless otherwise noted.

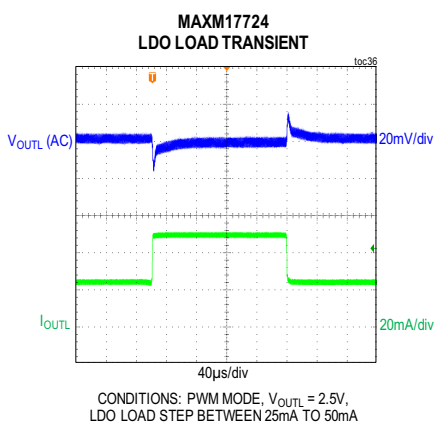
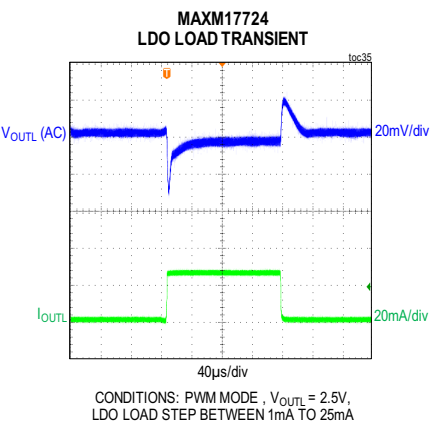
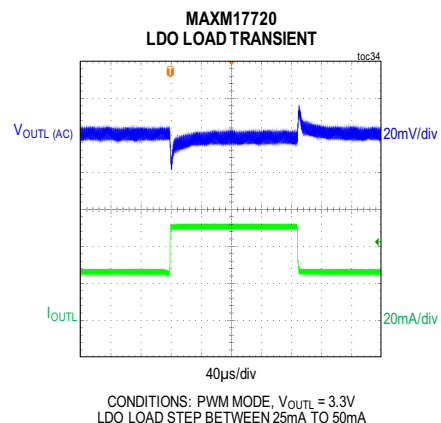
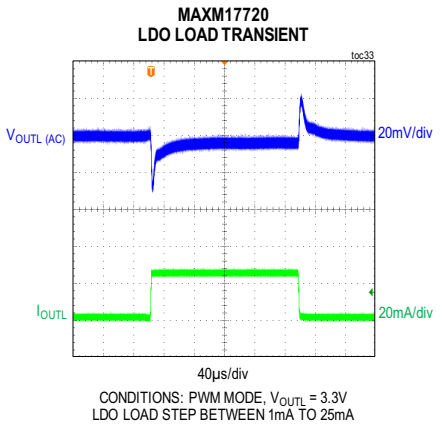
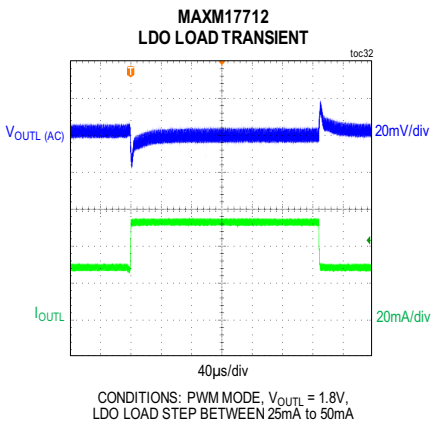
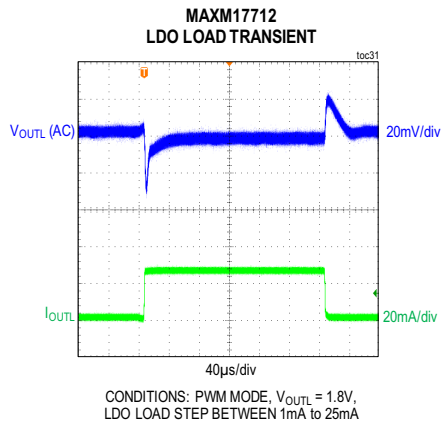
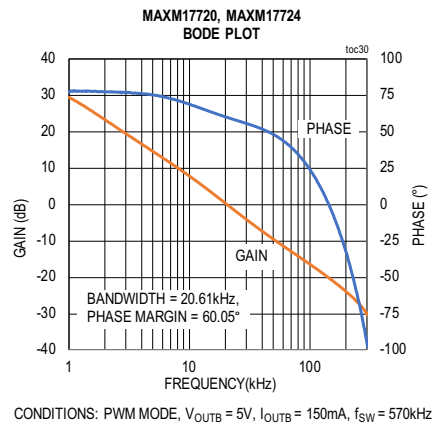
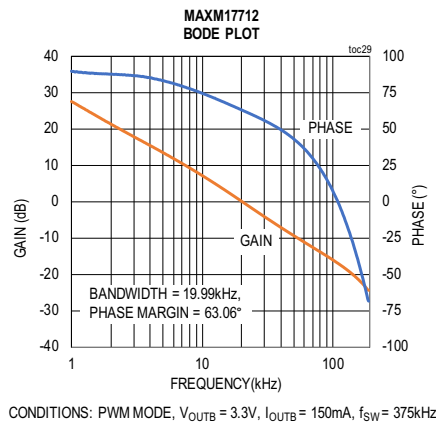
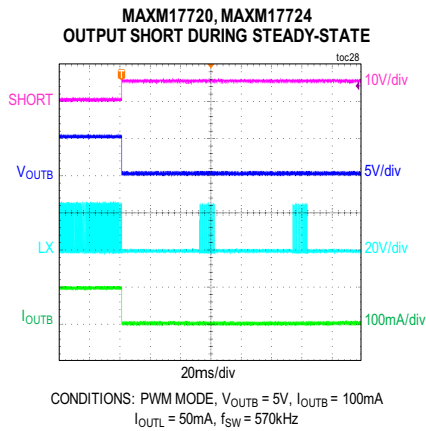

EV Kit Performance Report (continued)

$V_{IN} = 24V$, $T_A = 25^{\circ}C$, unless otherwise noted.

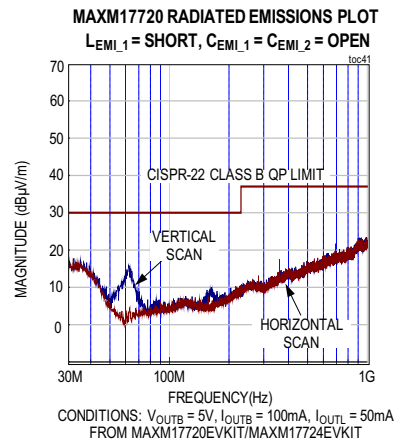
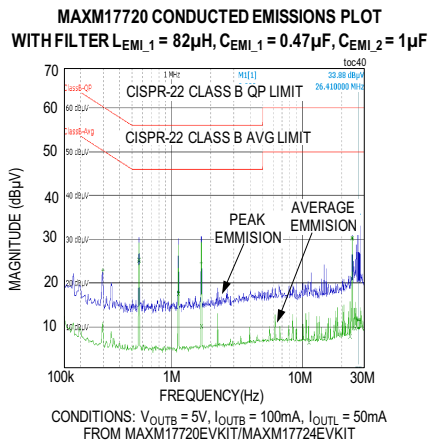
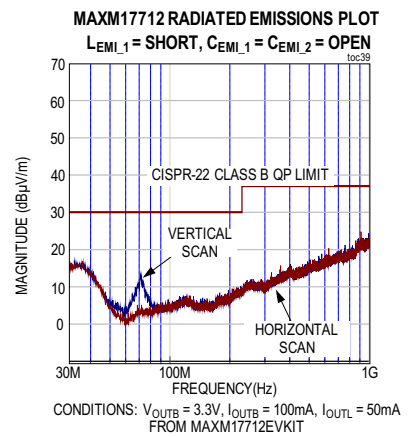
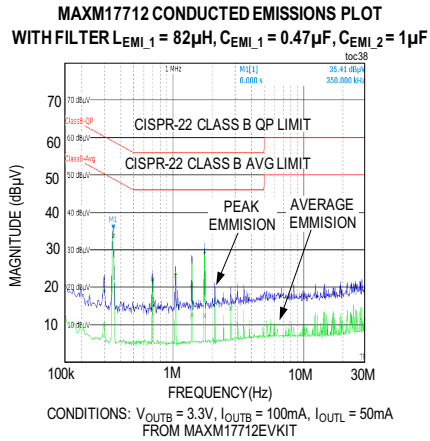
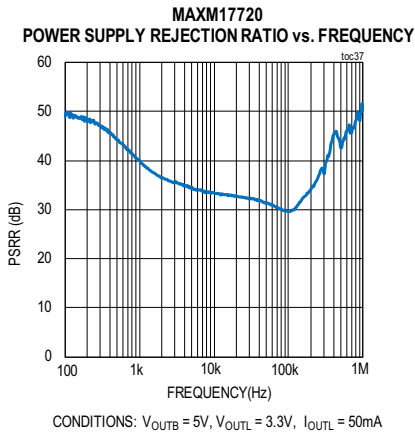

MAXM17712/MAXM17720/ MAXM17724 Evaluation Kit

Evaluates: MAXM17712/MAXM17720/ MAXM17724 Modules Application

Ordering Information

PART	TYPE
MAXM17712EVKIT#	EV Kit
MAXM17720EVKIT#	EV Kit
MAXM17724EVKIT#	EV Kit

#Denotes a RoHS-compliant device that may include lead(Pb) that is exempt under the RoHS requirements.

Component Suppliers

SUPPLIER	WEBSITE
Murata Americas	www.murata.com
Taiyo Yuden	www.yuden.co.jp
Nichicon	www.nichicon.co.jp
Vishay	www.vishay.com

Note: Indicate that you are using the MAXM17712/MAXM17720/MAXM17724 modules when contacting these component suppliers.

MAXM17712/MAXM17720/MAXM17724 EV Kit Bill of Materials

ITEM	QTY	DESIGNATION	DESCRIPTION	MANUFACTURER PART NUMBER
1	3	C12, C22, C32	4.7µF ± 20%, 100V; Aluminium capacitor	NICHICON UUR2A4R7MCL6GS
2	3	C13, C23, C33	1µF ±10%, 100V, X7R ceramic capacitor (1206)	TAIYO YUDEN HMK316B7105KLHT
3	3	C14, C24, C34	0.1µF ±10%, 100V, X7R ceramic capacitor (0603)	TAIYO YUDEN HMK107B7104KA
4	3	C15, C25, C35	10µF ±10%, 10V, X7R ceramic capacitor (0603)	MURATA GRM188Z71A106KA73
5	3	C17, C27, C37	2.2µF ±10%, 10V, X7R ceramic capacitor (0603)	MURATA GRM188R71A225KE15
6	3	R11, R21, R31	3.32MΩ ±1% resistor (0402)	VISHAY DALE CRCW04023M32FK
7	1	R12	953kΩ ±1% resistor (0402)	VISHAY DALE CRCW0402953KFKEDC
8	2	R22, R32	562kΩ ±1% resistor (0402)	VISHAY DALE CRCW0402562KFK
9	1	R15	127kΩ ±1% resistor (0402)	VISHAY DALE CRCW0402127KFK
10	2	R25, R35	78.7kΩ ±1% resistor (0402)	VISHAY DALE CRCW040278K7FK
11	1	R33	261kΩ ±1% resistor (0402)	VISHAY DALE CRCW0402261KFK
12	1	R34	49.9kΩ ±1% resistor (0402)	VISHAY DALE CRCW040249K9FK
13	3	R16, R26, R36	100kΩ ±1% resistor (0402)	VISHAY DALE CRCW0402100KFK
14	1	U1	MAXM17712, 10-pin micro-SLIC Power Module	MAXIM MAXM17712AMB+T
15	1	U2	MAXM17720, 10-pin micro-SLIC Power Modul	MAXIM MAXM17720AMB+T
16	1	U3	MAXM17724, 10-pin micro-SLIC Power Module	MAXIM MAXM17724AMB+T
17	3	C11,C21,C31	0.1µF ± 10%, 100V X7R ceramic capacitor (0603)	TAIYO YUDEN HMK107B7104KA
18	3	C18,C28,C38	0.1µF ± 10%, 16V X7R ceramic capacitor (0402)	TAIYO YUDEN EMK105B7104KV
19	1	LEMI_1	OPTIONAL: 82µH±20%,150mA Shielded Wirewound Inductor (2016)	MURATA LQH2MPN820MGRL
20	1	CEMI_1	OPTIONAL: 0.47µF±10%, 100V, X7R ceramic capacitor (1206)	MURATA GRM31MR72A474KA35L
21	1	CEMI_2	OPTIONAL: 1µF±10%, 100V, X7R ceramic capacitor (1206)	TAIYO YUDEN HMK316B7105KLHT
22	3	C16,C26,C36	OPTIONAL: open (0805)	
23	3	C19,C29,C39	OPTIONAL: open (0603)	

MAXM17712/MAXM17720/MAXM17724 EV Kit Schematics

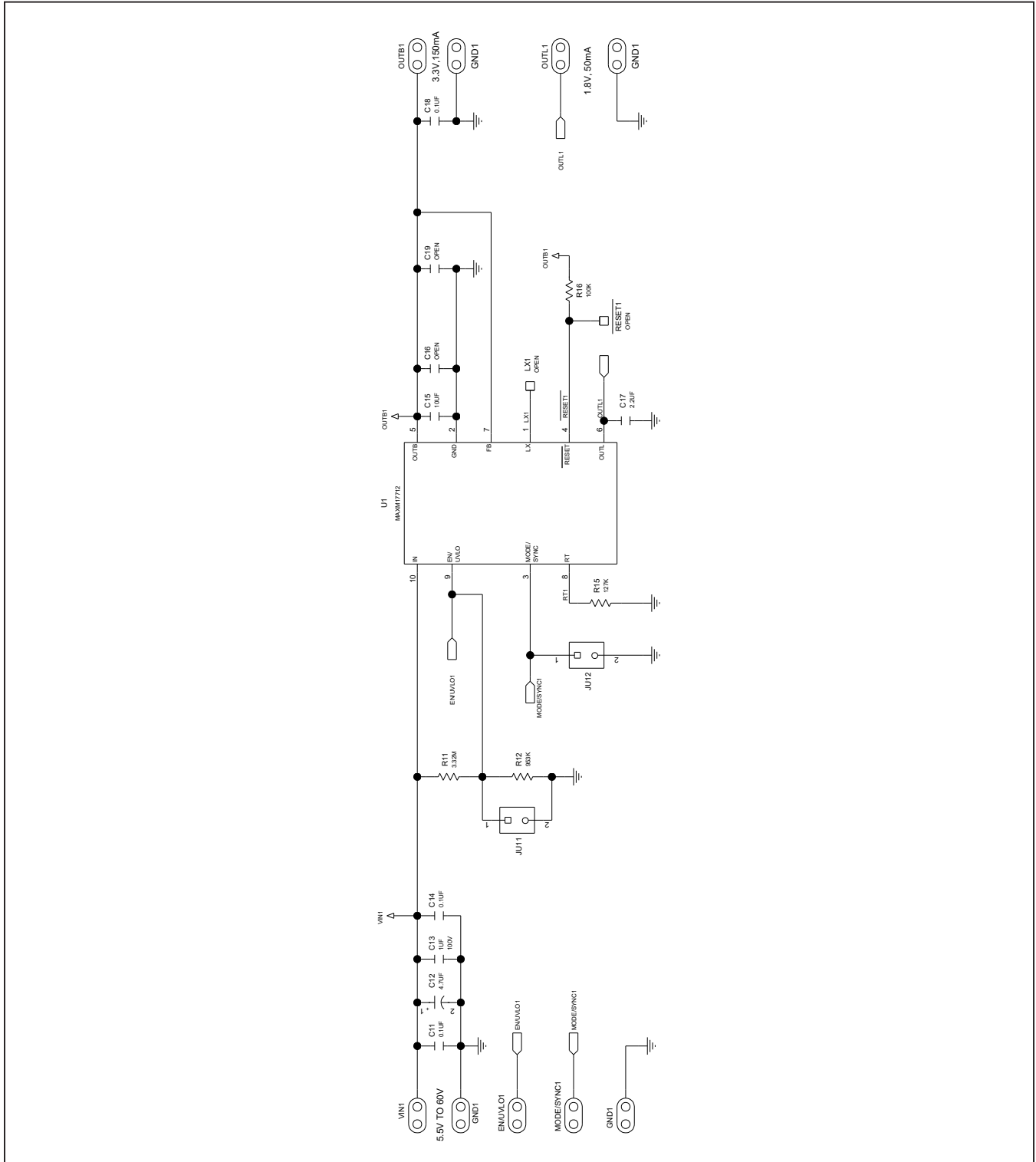

MAXM17712/MAXM17720/MAXM17724 EV Kit Schematics (continued)

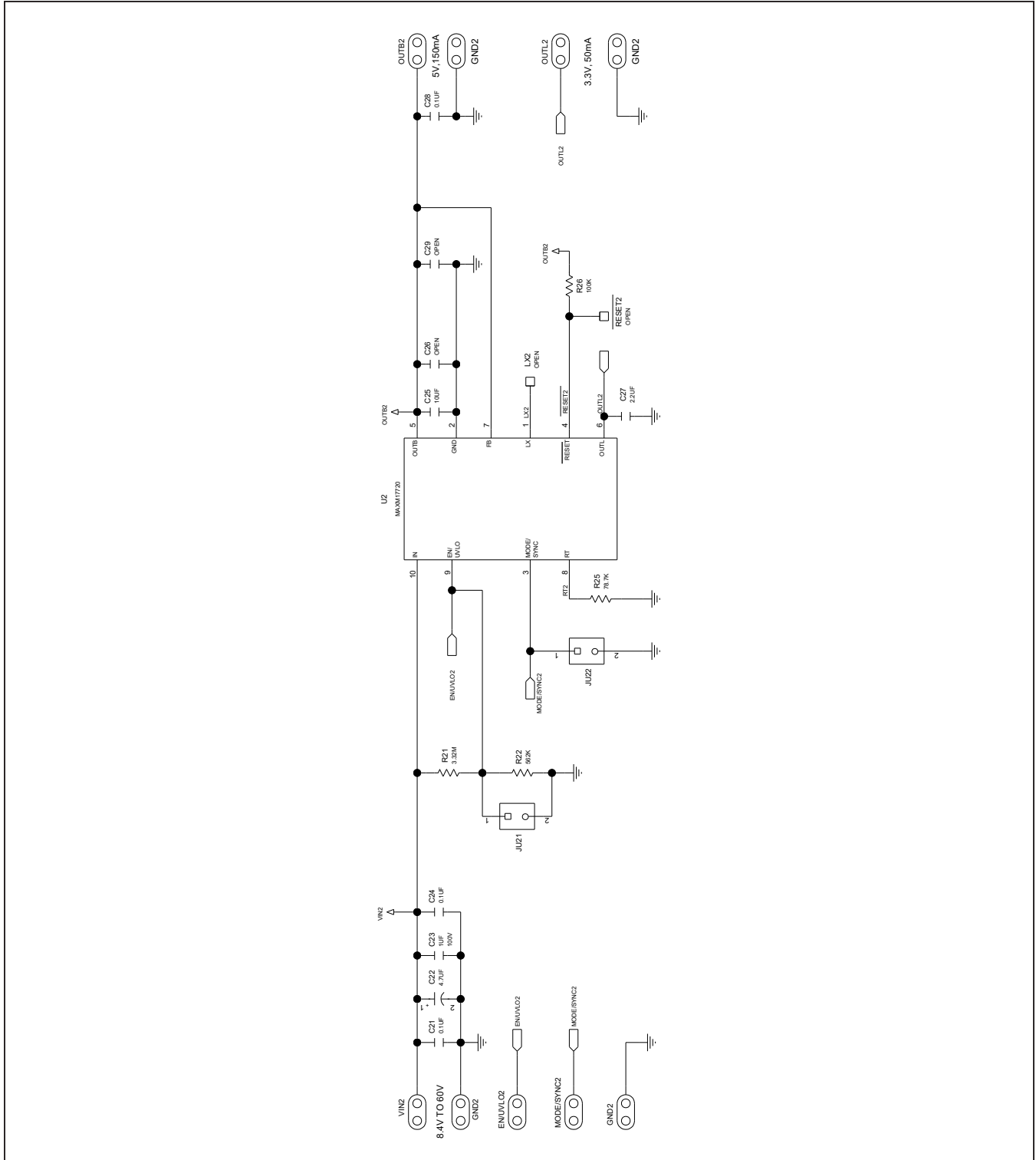

MAXM17712/MAXM17720/MAXM17724 EV Kit Schematics (continued)

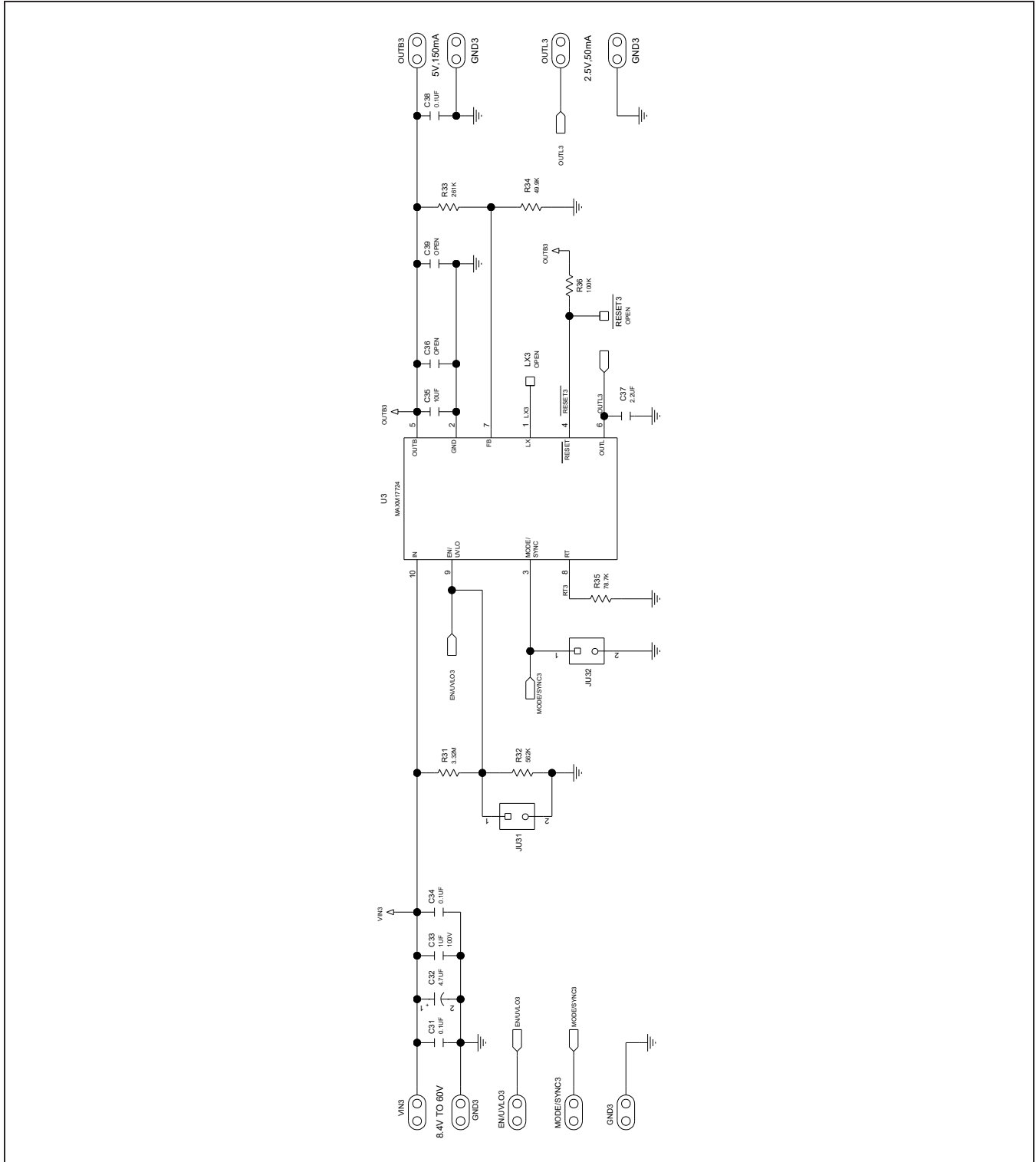

MAXM17712/MAXM17720/MAXM17724 EV Kit PCB Layout Diagrams

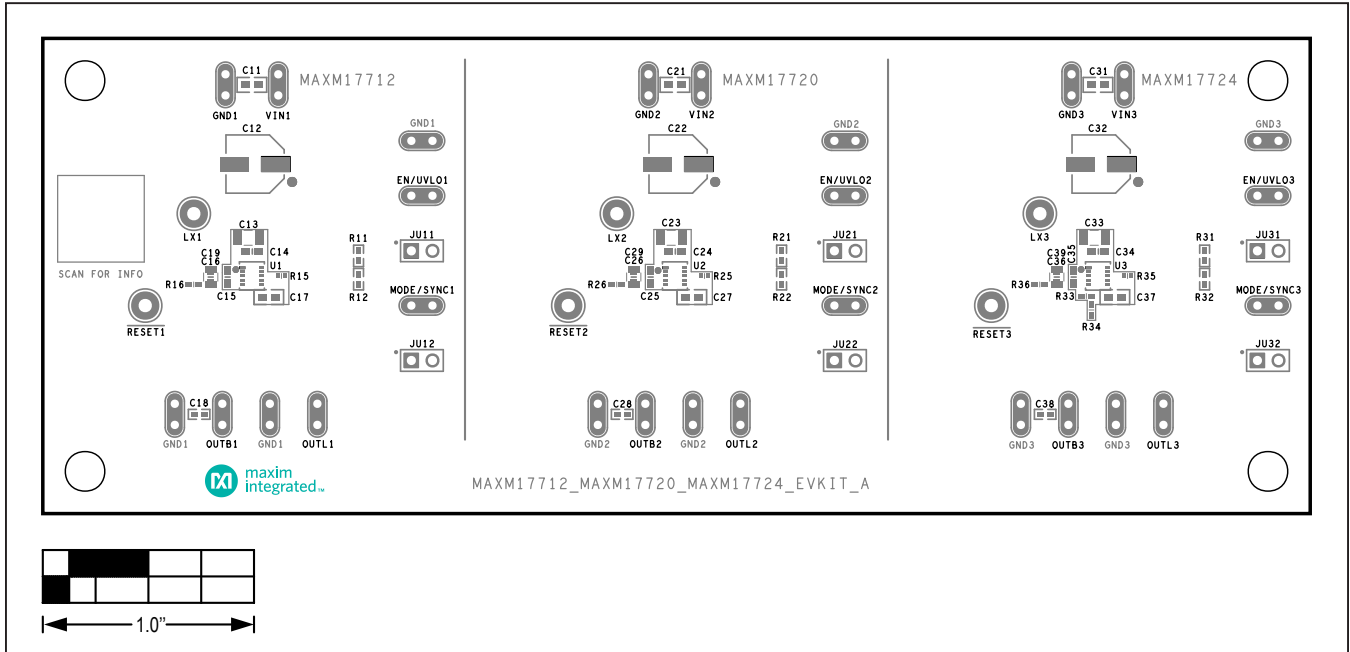

MAXM17712-20-24 EV kit PCB Layout—Top Silkscreen

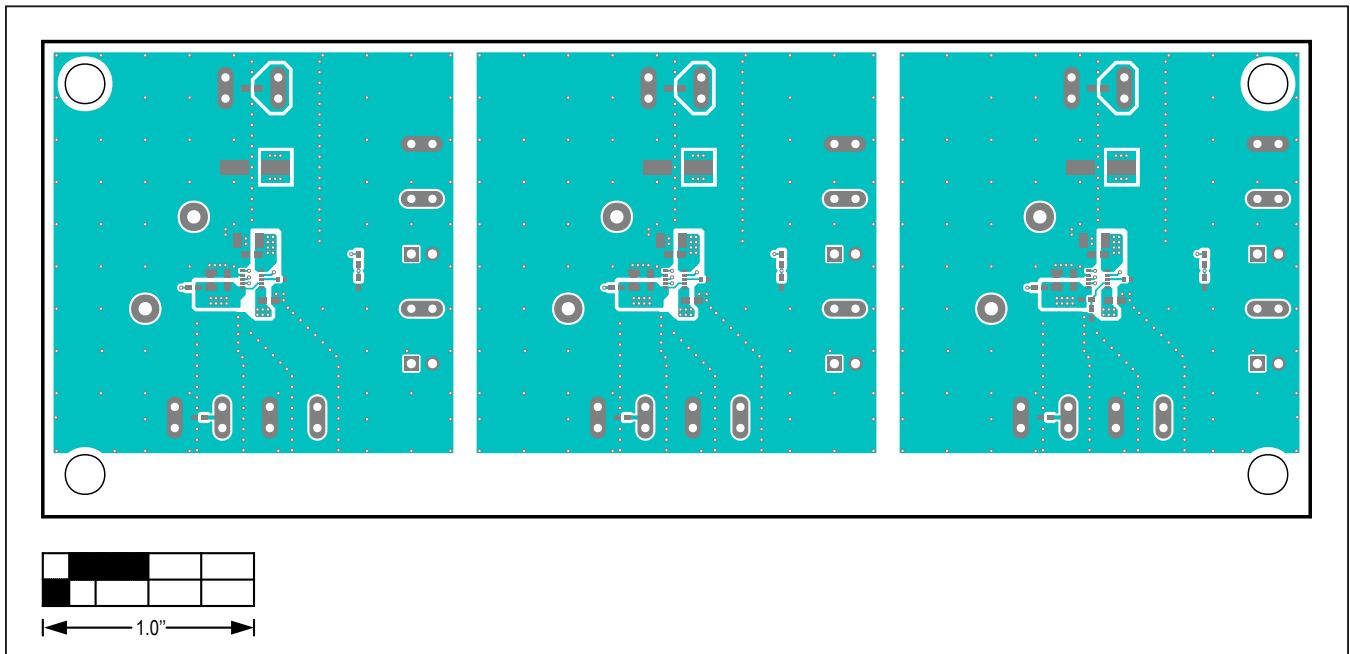

MAXM17712-20-24 EV kit PCB Layout—Top Layer

MAXM17712/MAXM17720/MAXM17724 EV Kit PCB Layout Diagrams (continued)

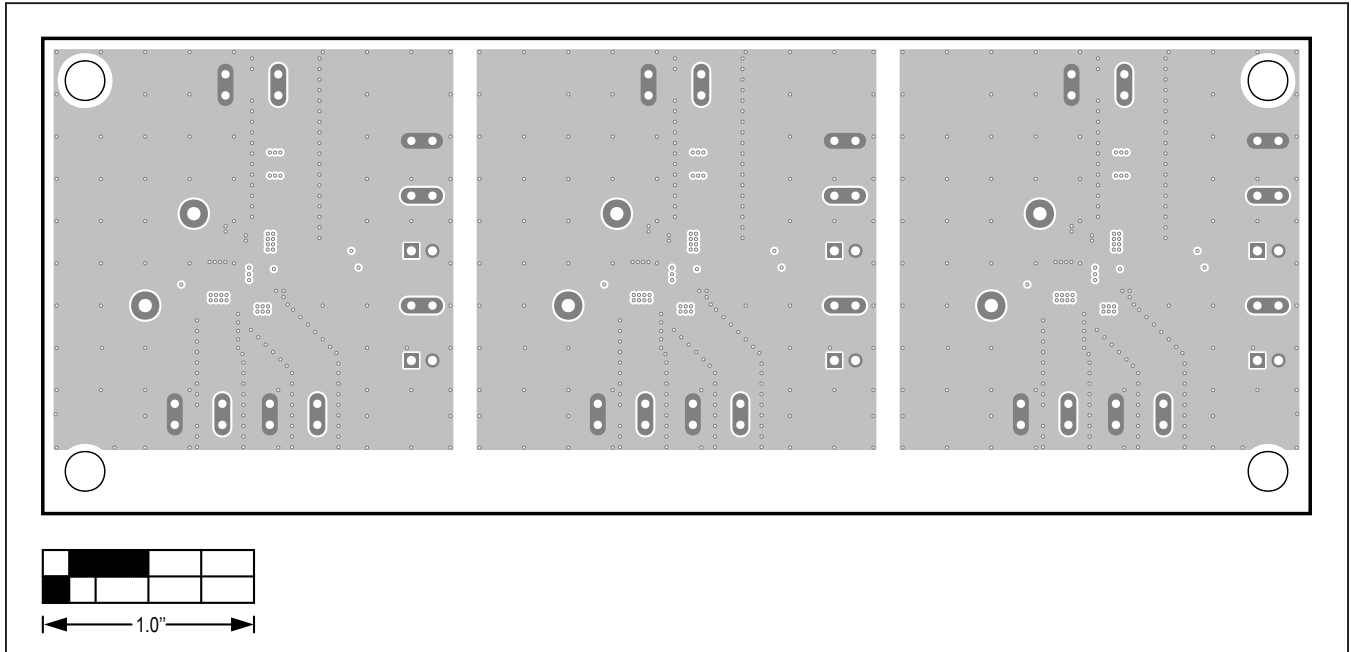

MAXM17712-20-24 EV kit PCB Layout—Layer 2

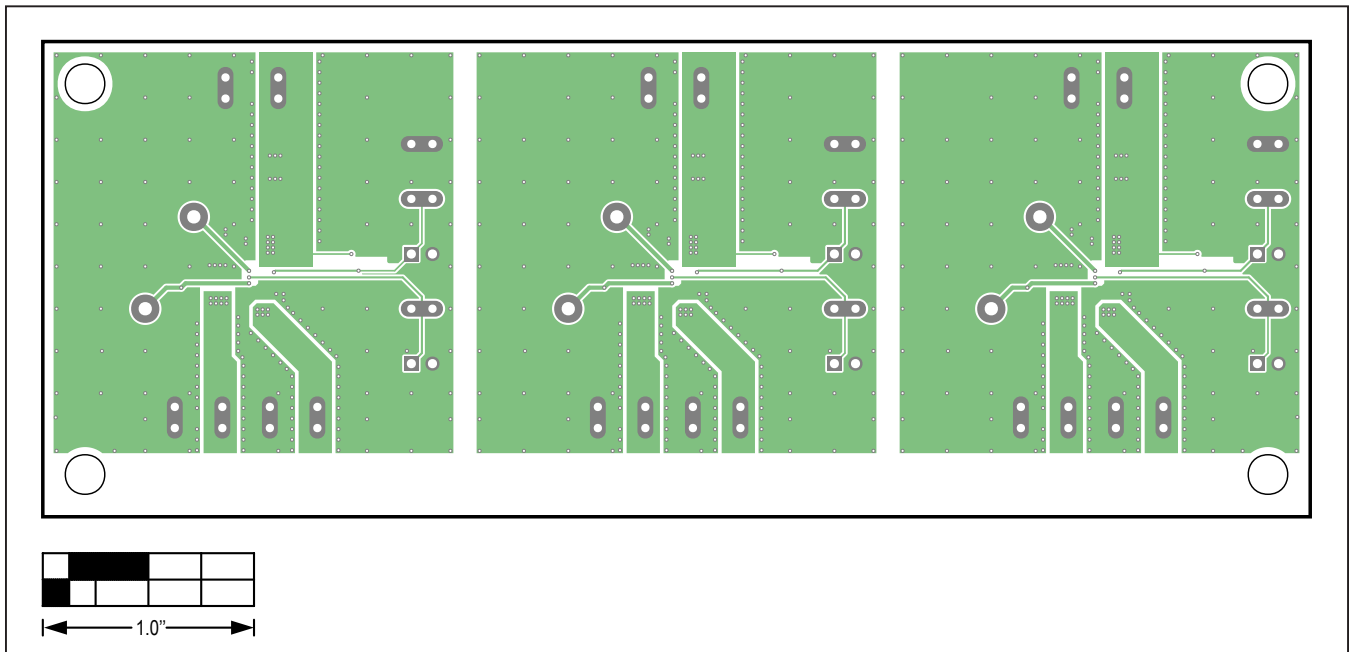

MAXM17712-20-24 EV kit PCB Layout—Layer 3

MAXM17712/MAXM17720/MAXM17724 EV Kit PCB Layout Diagrams (continued)

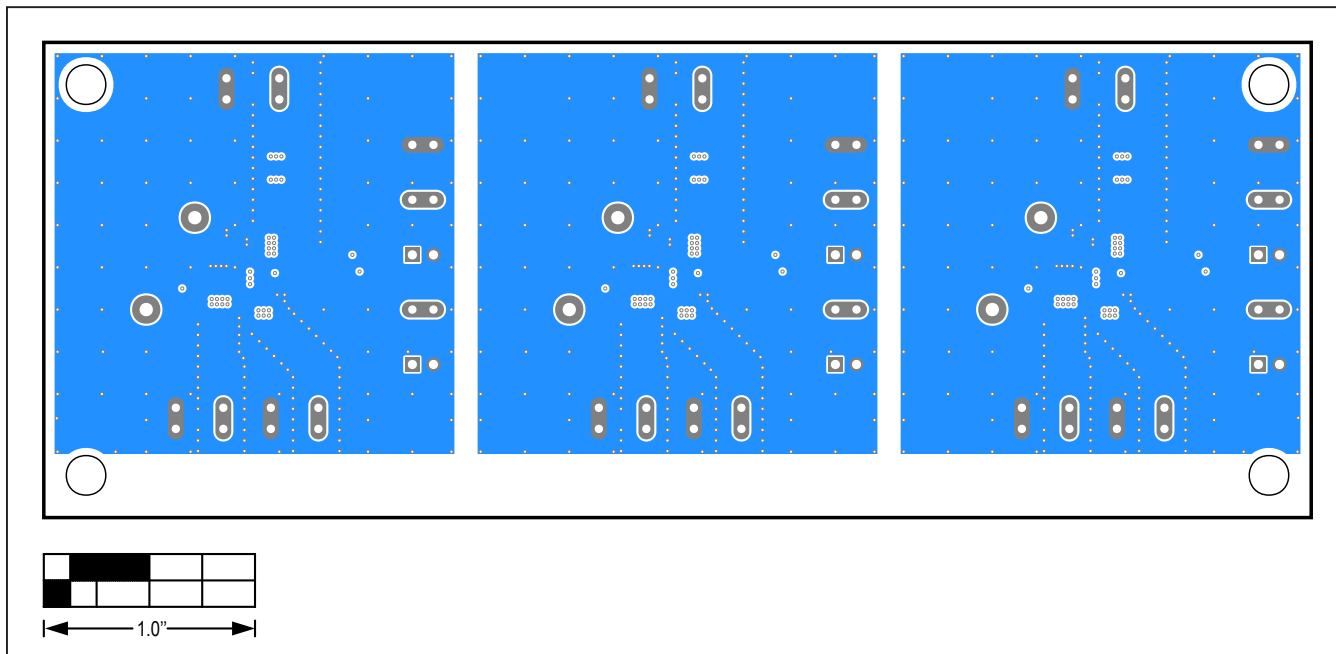

MAXM17712-20-24EV kit PCB Layout—Bottom Layer

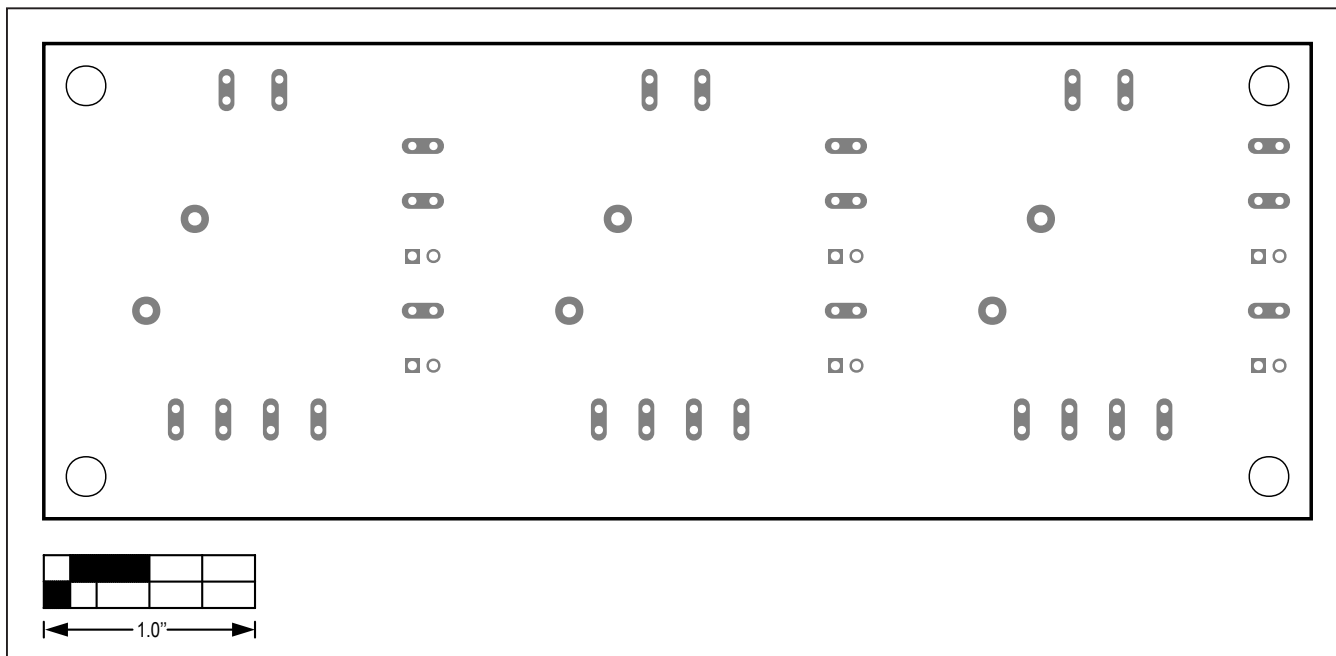

MAXM17712-20-24EV kit PCB Layout—Bottom Silkscreen