



Click [here](#) to ask an associate for production status of specific part numbers.

Evaluates: MAXM86161

MAXM86161EVSYS# Evaluation System

General Description

The MAXM86161EVSYS# evaluation system (EV system) allows for the quick evaluation of the MAXM86161 integrated optical module for applications at various sites on the body, particularly in-ear and mobile applications. The MAXM86161 device communicates using a standard I²C-compatible interface to Maxim's on-board MAX32664 Biometric Sensor Hub microcontroller (used for Maxim's algorithm evaluation) or in a pass-through mode for raw data collection. The MAXM86161 device consists of three optical readout channels that can be individually controlled (Green, Red, and IR). The EV system allows for flexible configurations to allow testing of various features of the sensor. Moreover, it helps the user quickly learn how to configure and use the MAXM86161 device.

The primary EV system consists of two circuit board assemblies (MAXSensorBLE_EVKIT and MAXM86161OSBFLEX), one USB-C to USB-A connector cable, and a Lithium Polymer battery. These components are highlighted in [Figure 1](#) below. In addition, two programming circuit boards (MAXM86161_MAX32630_PRGMR_ASSY, and the MAXREFDES100HDK) and one USB-B Micro-to-USB-A Male USB cable are provided for firmware updates if needed.

The EV system can be powered using a USB-C supply or LiPo Battery and comes with a MAXM86161EFD+ device in a 14-pin OLGA package.

The MAXM86161OSBFLEX Flex-Rigid circuit board has a Maxim Integrated MAX32664 Biometric Sensor Hub microcontroller device installed. This Sensor Hub can be used to implement Maxim's HR/SpO₂ Algorithm for evaluation. The MAXM86161 GUI PC application code that allows evaluation of both the MAXM86161EVSYS# and the MAX32664 Sensor Hub is available in the [MAXM86161EVSYS# EV System Design Resources](#) tab.

Features

- Performance Evaluation of the MAXM86161 Sensor (e.g., SNR, Dark Current, Noise, etc.)
- Performance Evaluation of Maxim Algorithms for Power Optimization, Heart Rate (HR), SpO₂ (Peripheral Capillary Oxygen Saturation), etc. Using the On-Board MAX32664GWEC+ Biometric Sensor Hub Microcontroller
- Facilitates Understanding of MAXM86161 Architecture and Solution Strategy
- Real-Time Monitoring and Data Logging Capabilities
- On-Board Accelerometer
- Bluetooth® LE for wireless data collection

MAXM86161EVSYS# EV System Files

FILE	DESCRIPTION
MAXM86161OSBFLEX.ZIP	Sch, BOM, Layout
MAXSensorBLE.ZIP	Sch, BOM, Layout
MAX32644FTHR.ZIP	Sch, BOM, Layout
MAXM86161ADPTR	Sch, BOM, Layout
MAXREFDES100HDK	Sch, BOM, Layout
MAXM86161 GUI	Executable PC S/W File

The GUI and other documentation to use this EV System are available in the [MAXM86161EVSYS# EV System Design Resources](#) tab and at the [MAXREFDES100HDK](#) website.

[Ordering Information](#) appears at end of data sheet.

Bluetooth word mark and logos are registered trademarks owned by Bluetooth SIG, Inc.

319-100382; Rev 1; 4/22

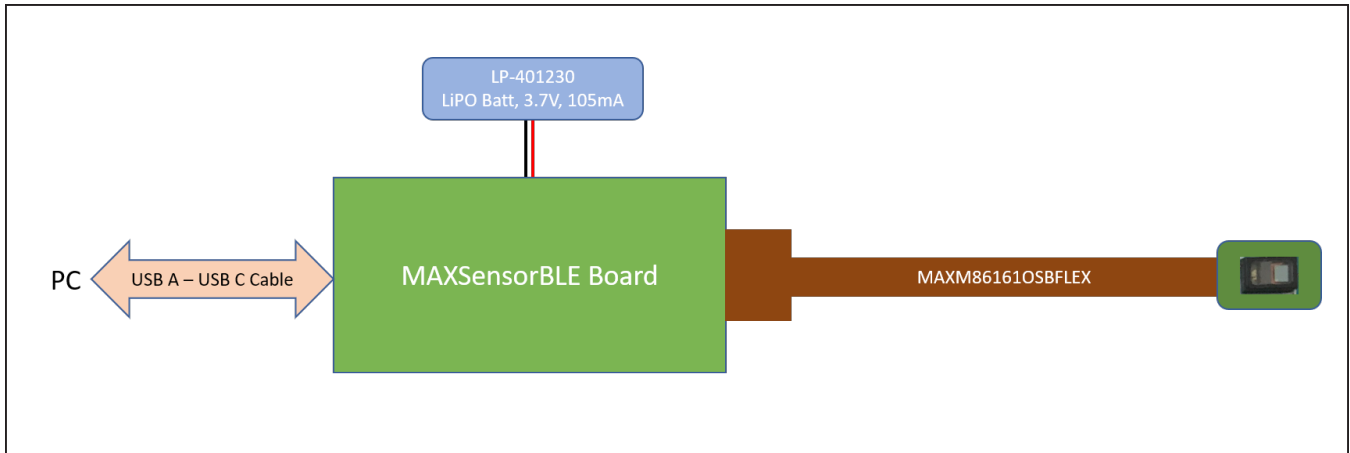

Figure 1. MAXM86161 EV System Block Diagram

Quick Start

Required Equipment

- MAXM86161EVSYS#
- MAXM86161 EV system GUI software
- Windows® System with a USB port and Bluetooth® 4 with BLE supported on its Hardware (Win BLE)

Procedure

- 1) Check that the MAXM86161OSBFLEX Board and the MAXSensorBLE Board are connected as shown in [Figure 2](#) and [Figure 3](#).

- 2) Connect a USB-C cable to the MAXSensorBLE Board to power up the EV system. When powered on, the LED toggles red and yellow.
- 3) Enable Bluetooth® on user's Windows® System/PC.
- 4) Visit www.maximintegrated.com/MAXM86161EVSYS to download the most recent version of the EV system software, MAXM86161GUISetupVxxx.ZIP. Save the EV system software to a temporary folder and uncompress the ZIP file.

Windows is a registered trademark of Microsoft Corporation.

**MAXM86161EVSYS#
Evaluation System**

Evaluates: MAXM86161

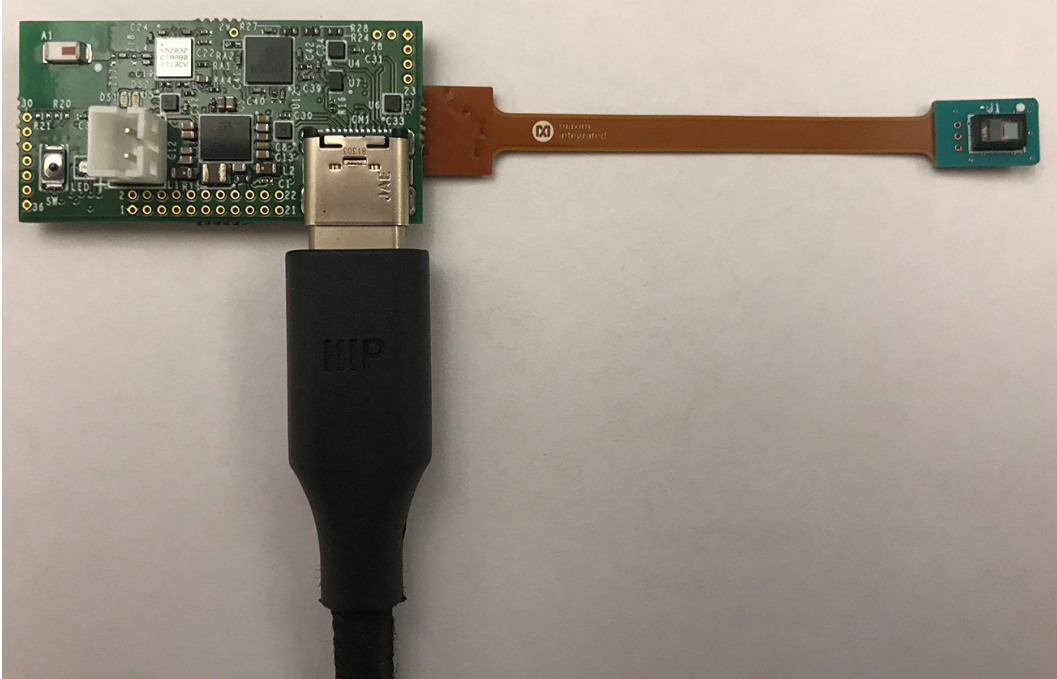

Figure 2. Hardware Setup (MAXM86161 EV System Micro PCB)

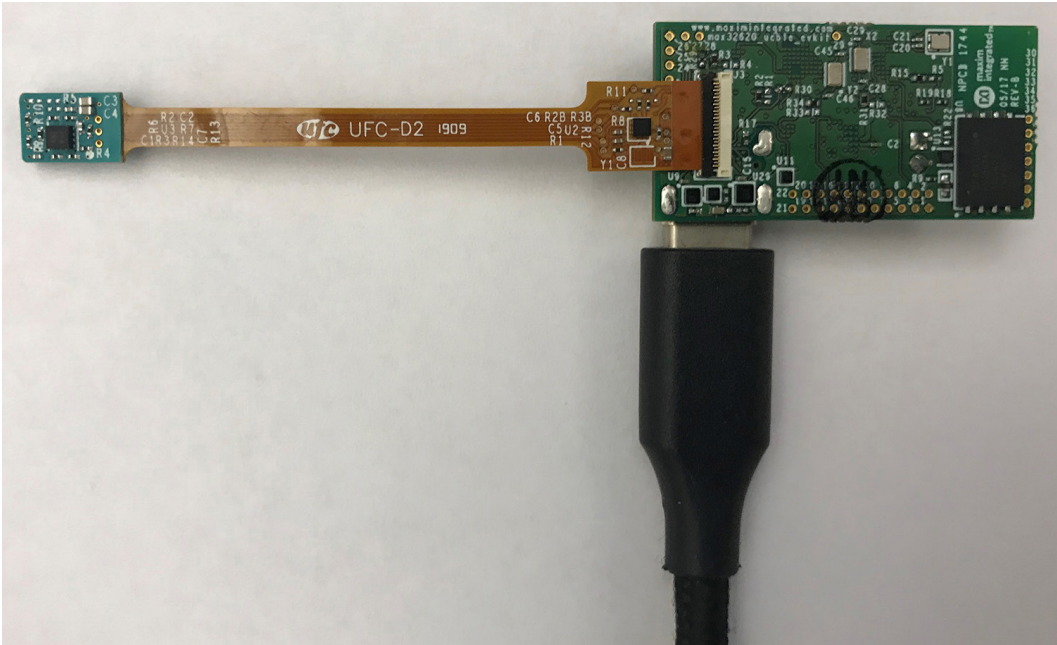

Figure 3. Hardware Setup (MAXM86161 EV System Sensor PCB)

MAXM86161EVSYS# Evaluation System

Evaluates: MAXM86161

- 5) Open up MAXM86161GUISetupVxxx.exe and follow the instructions from the pop-up windows as shown in [Figure 4](#) to [Figure 10](#).

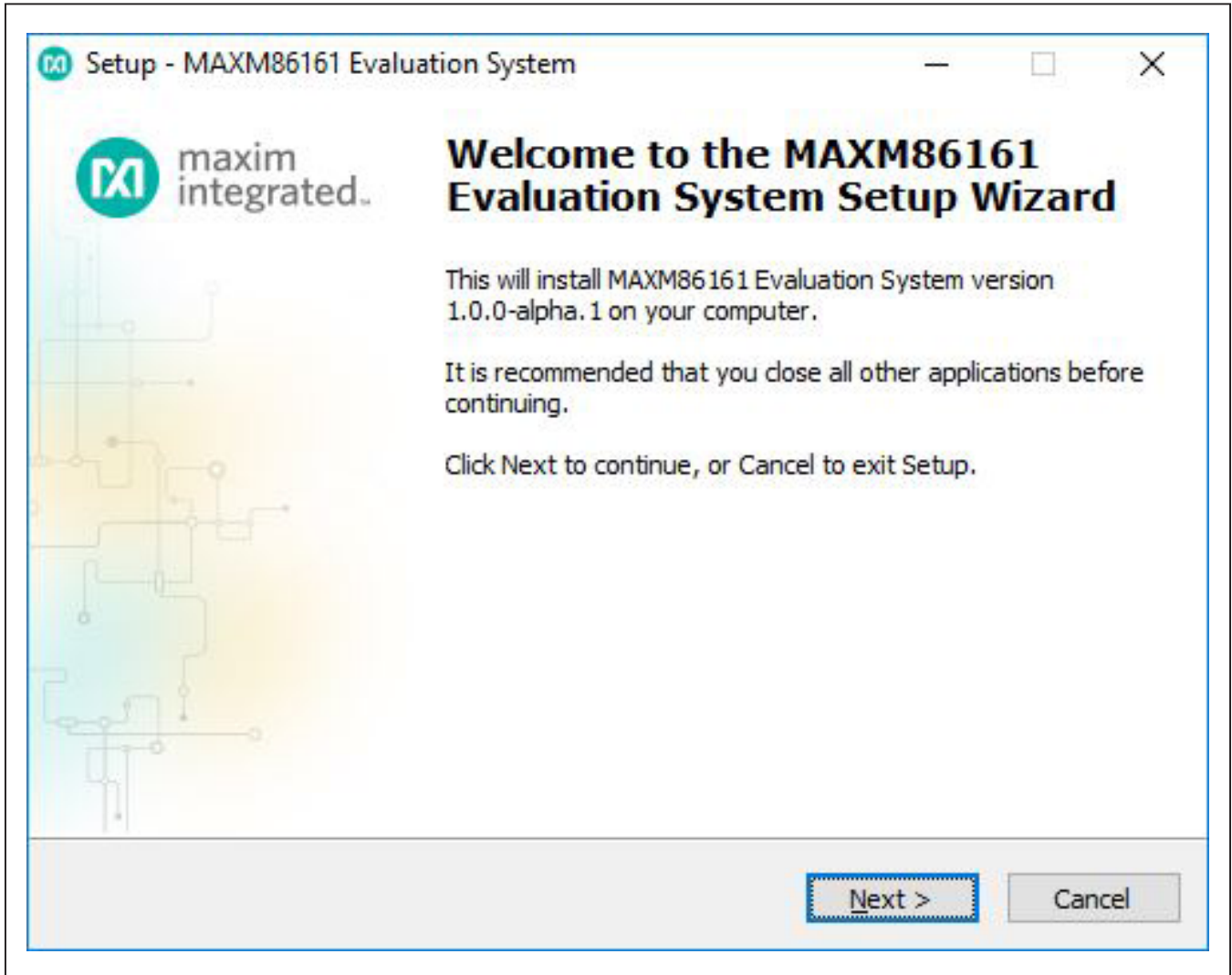

Figure 4. Setup MAXM86161 EV System GUI Software Step 1

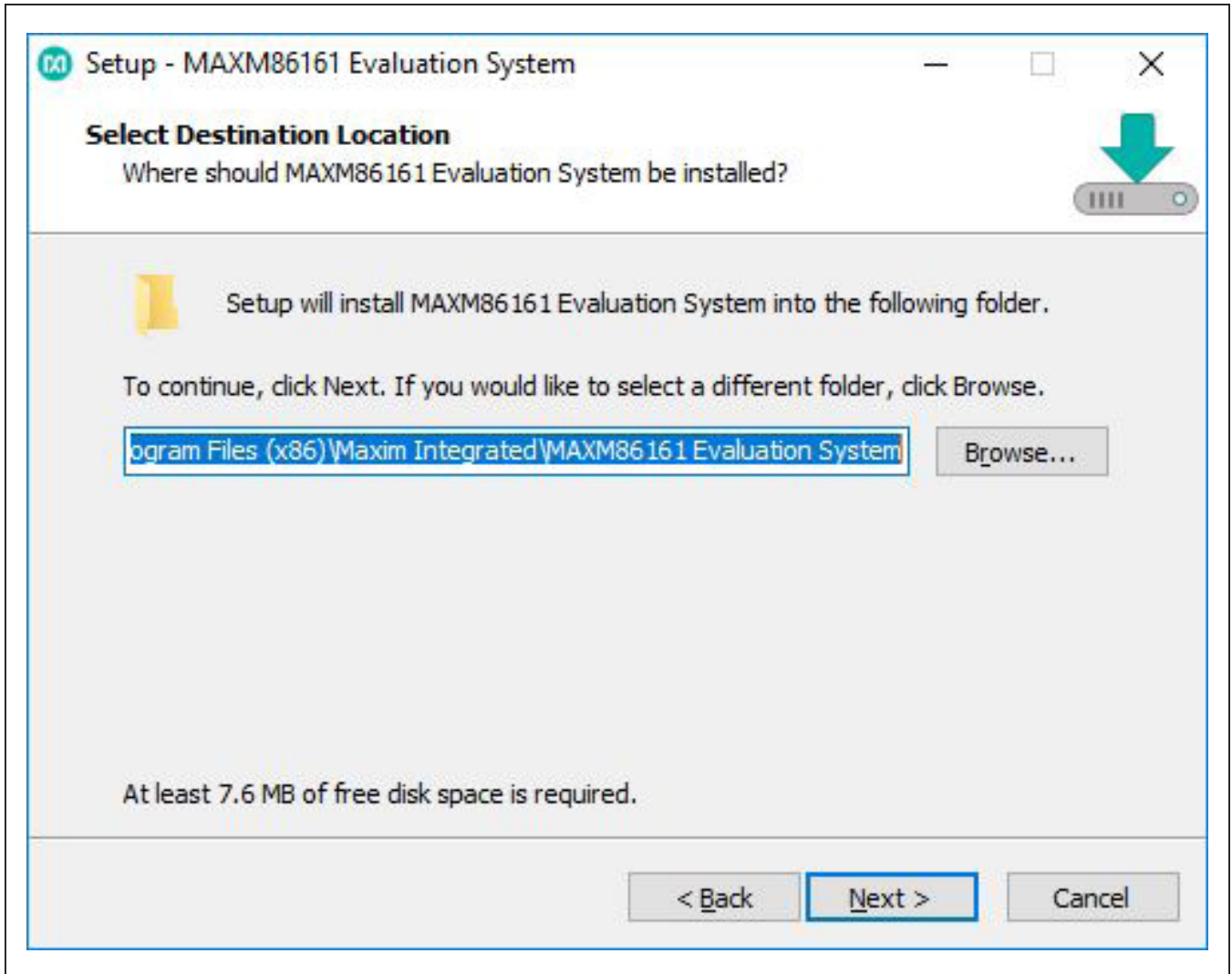

Figure 5. Setup MAXM86161 EV System GUI Software Step 2

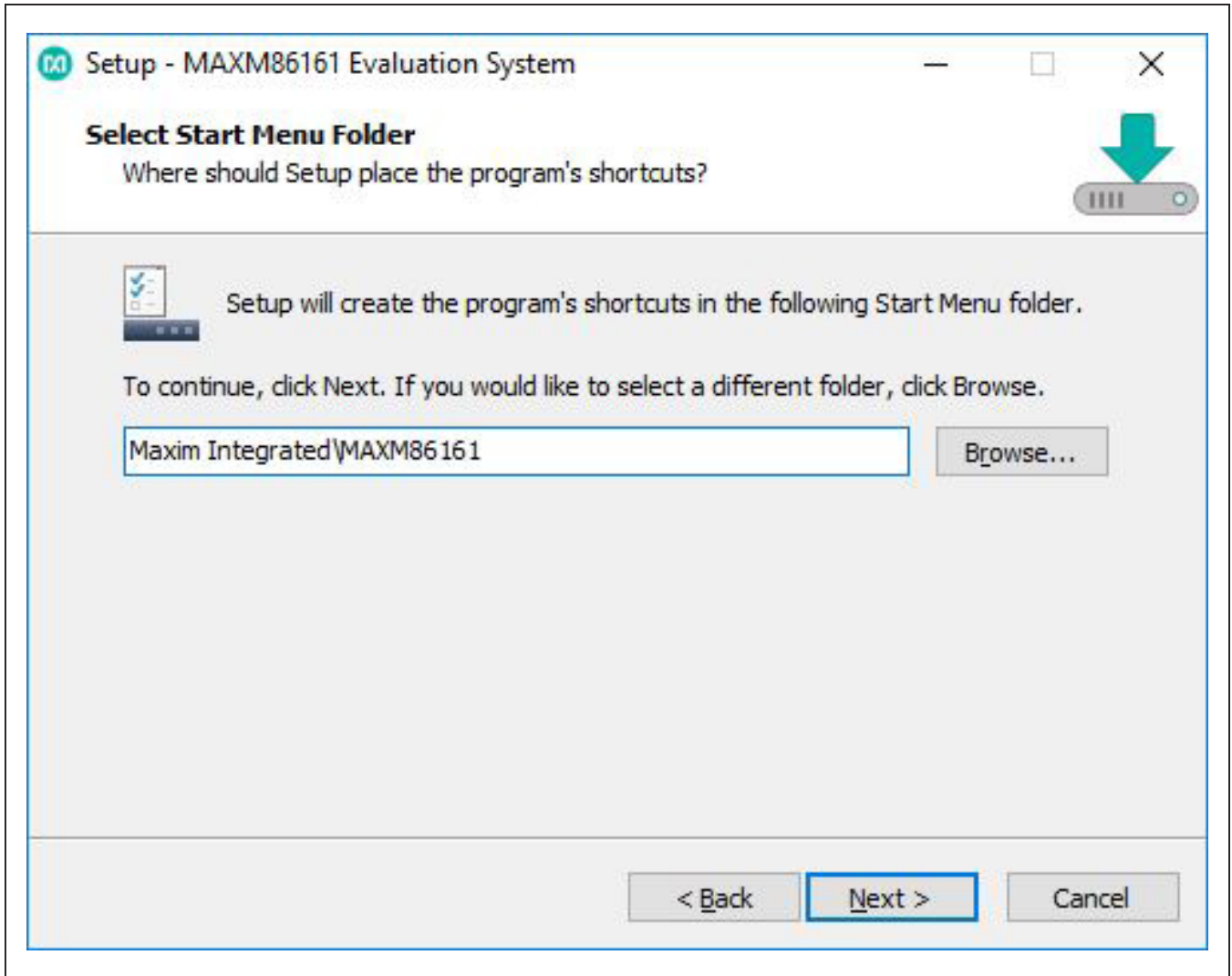

Figure 6. Setup MAXM86161 EV System GUI Software Step 3

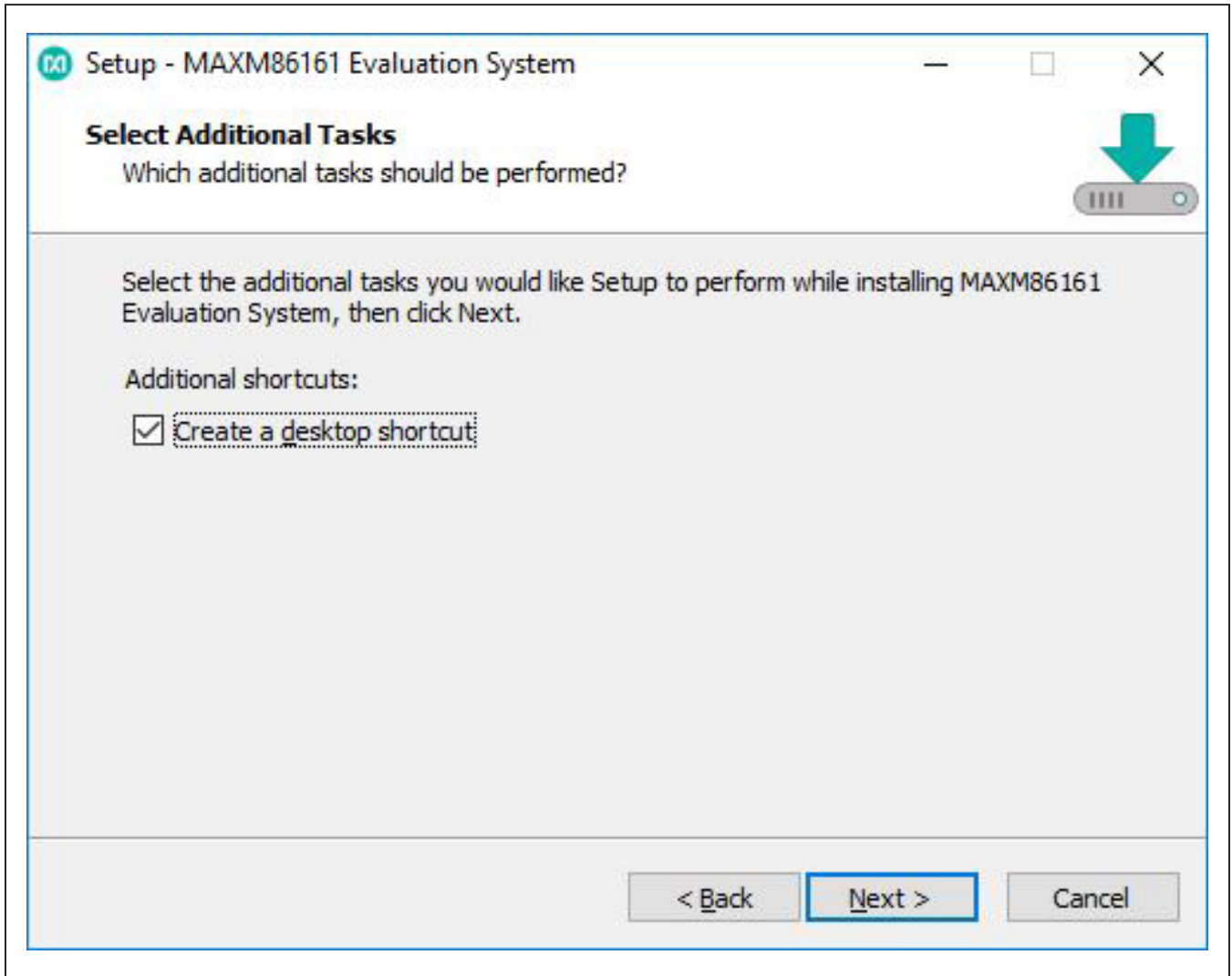

Figure 7. Setup MAXM86161 EV System GUI Software Step 4

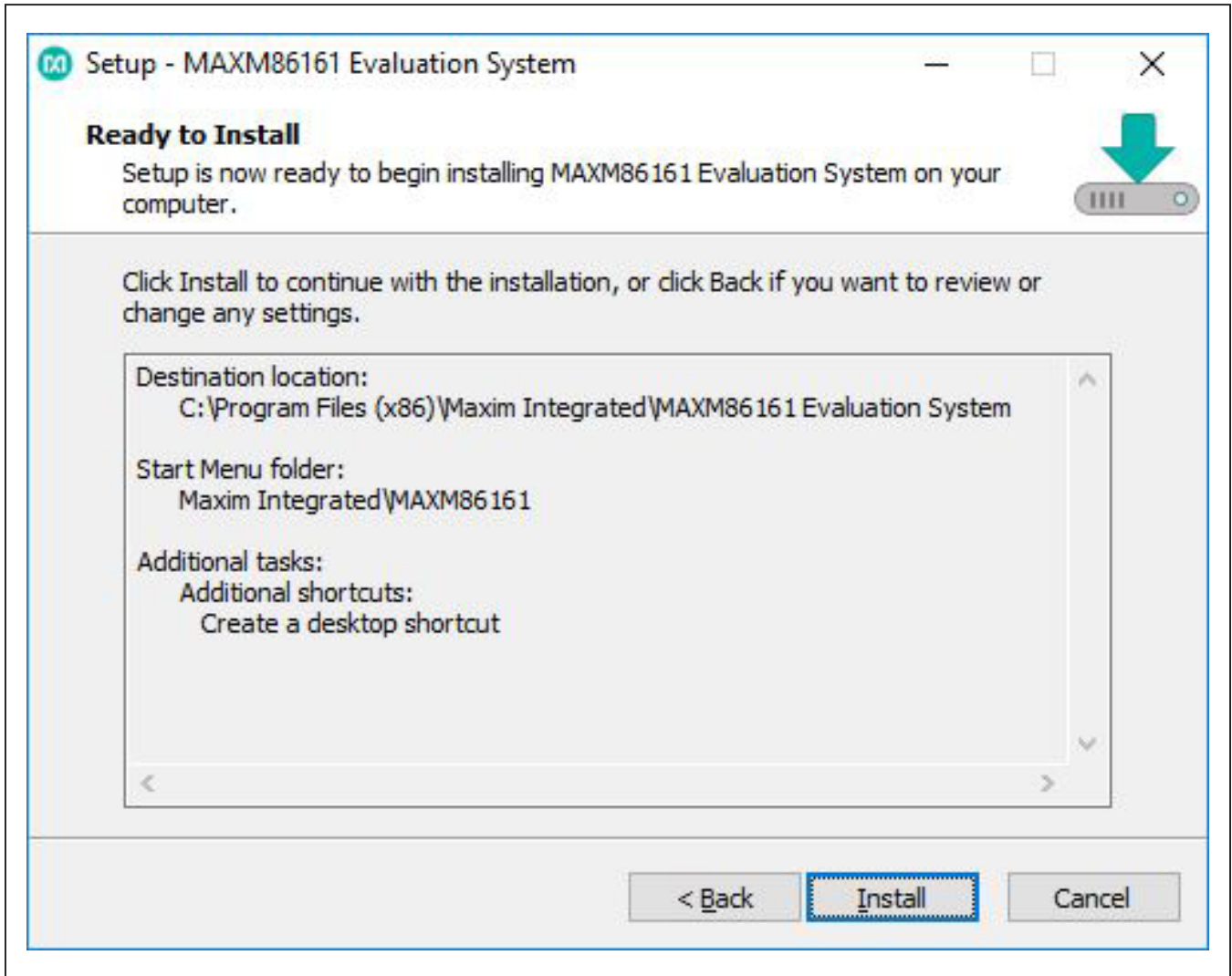

Figure 8. Setup MAXM86161 EV System GUI Software Step 5

MAXM86161EVSYS# Evaluation System

Evaluates: MAXM86161

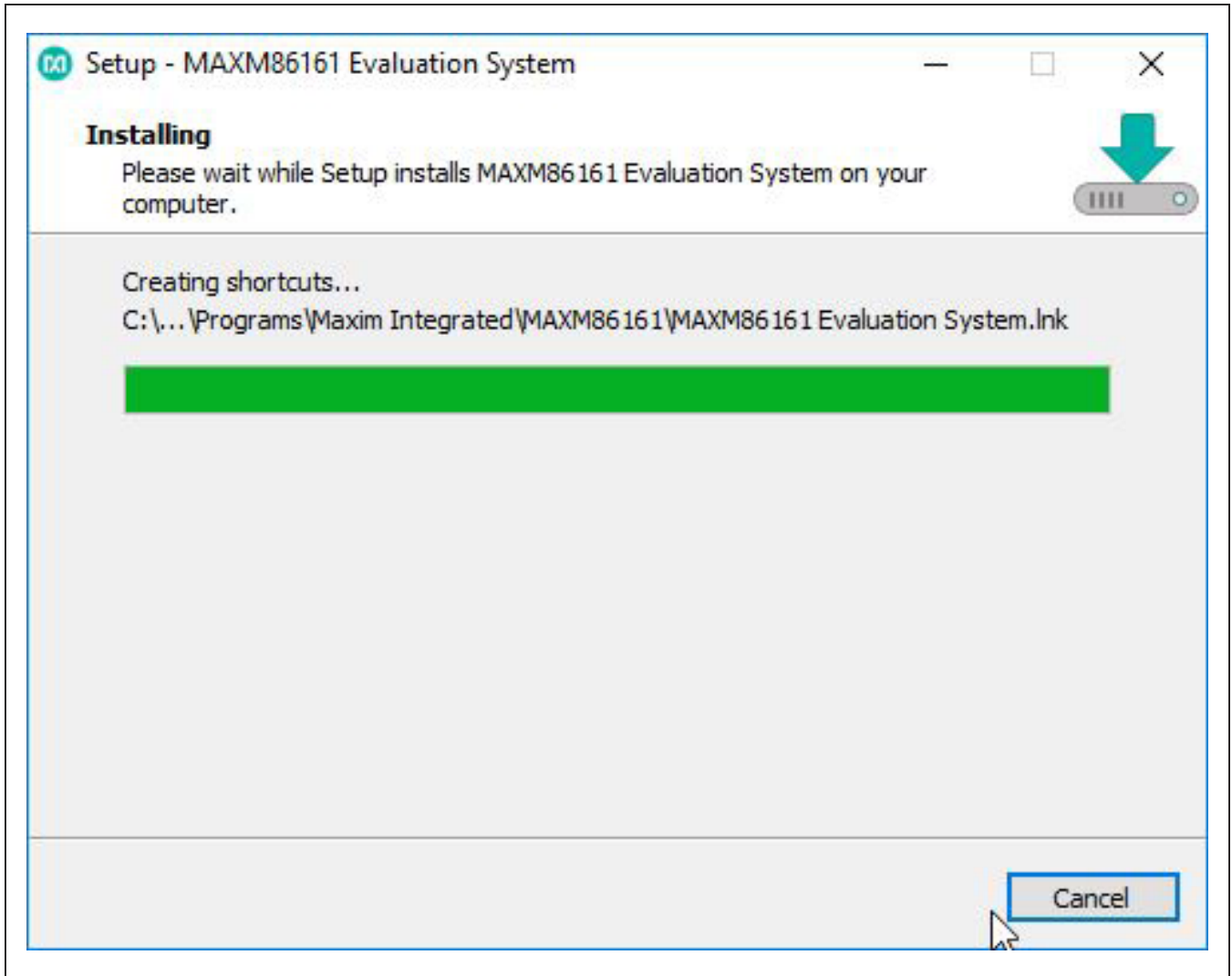

Figure 9. Setup MAXM86161 EV System GUI Software Step 6

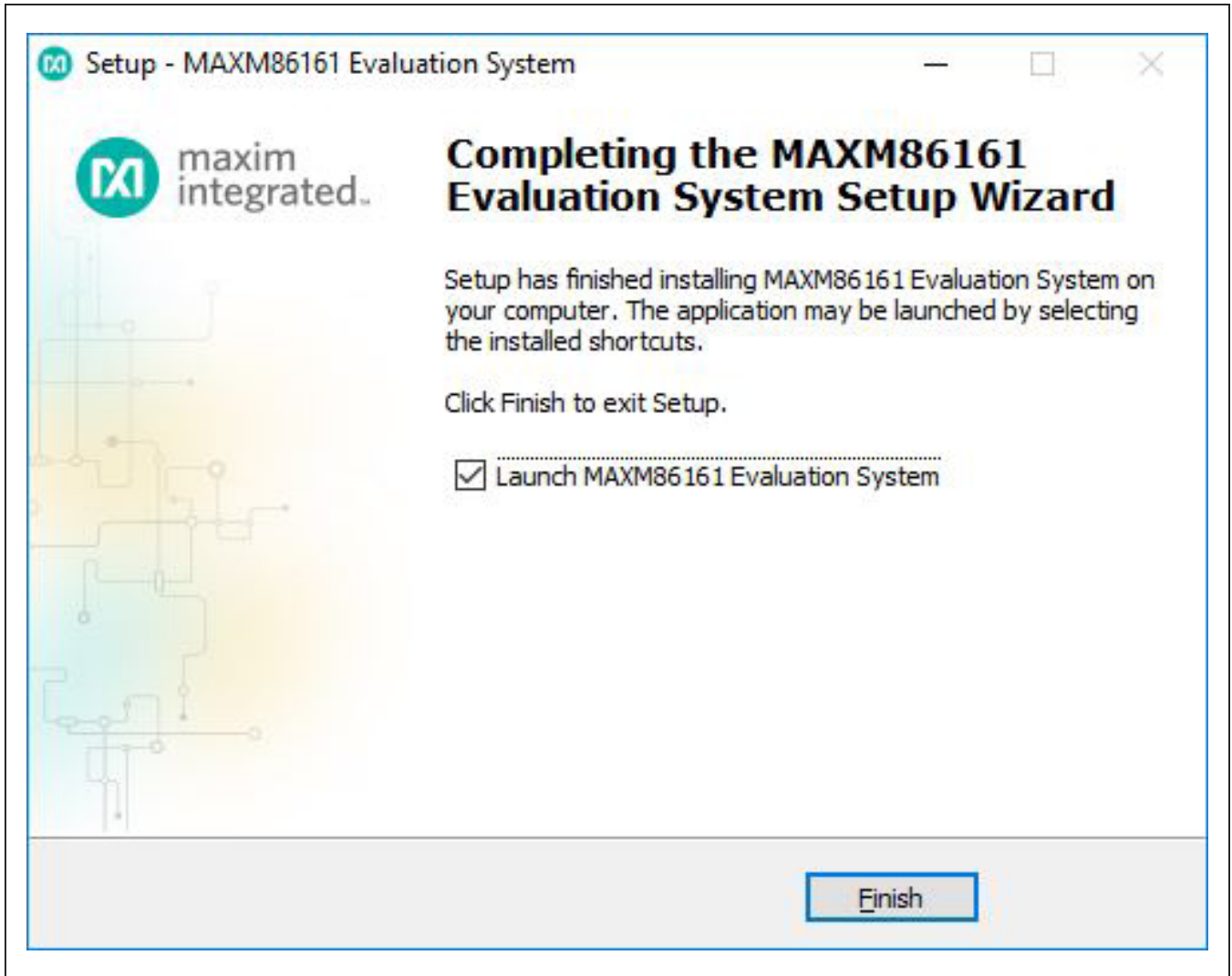

Figure 10. Setup MAXM86161 EV System GUI Software Step 7

- 6) Press “Finish.” Next, the “Connect To Device” window appears. Choose your device and press “Connect” as shown in [Figure 11](#).

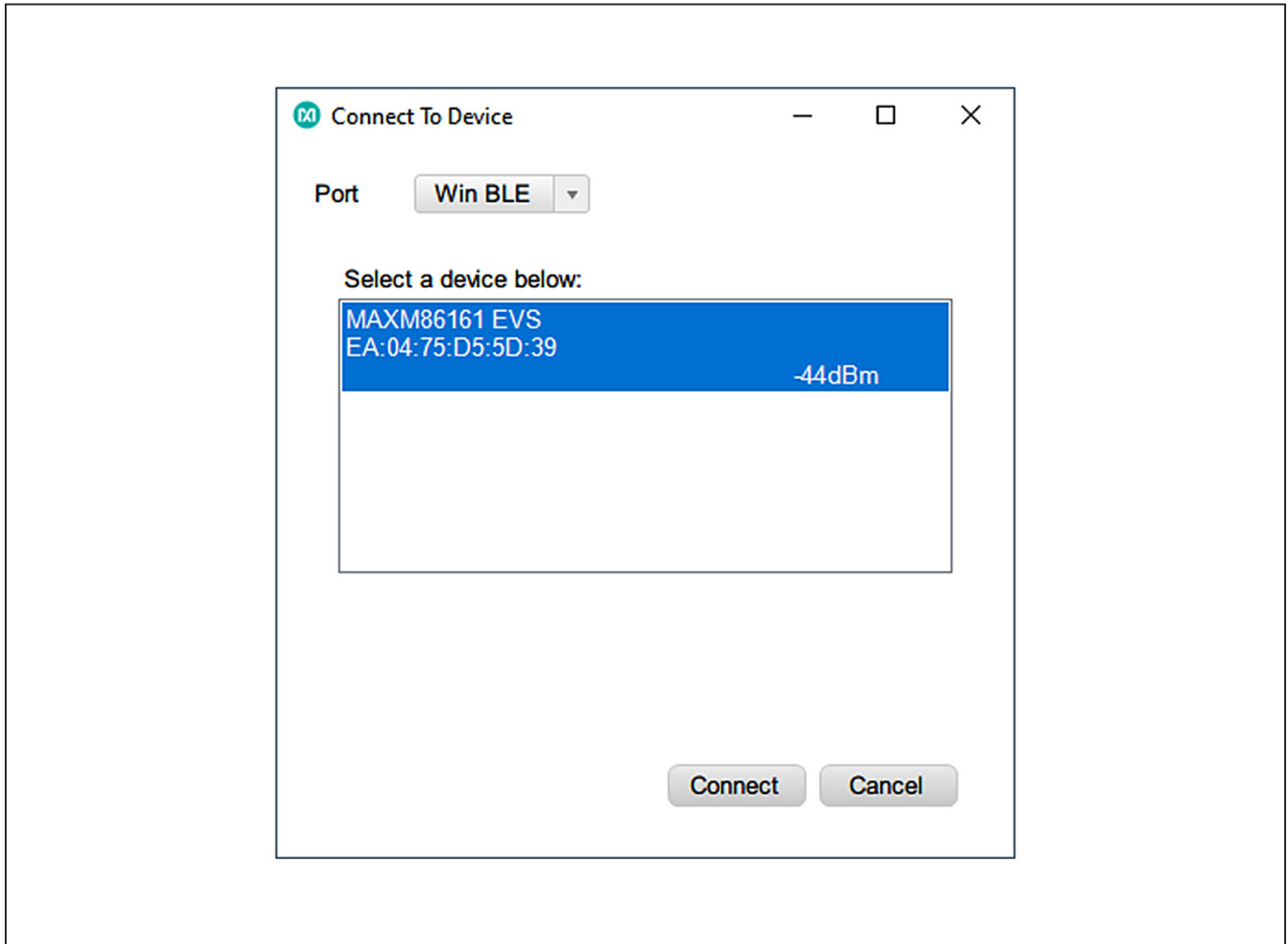

Figure 11. Connect to BLE Device

MAXM86161EVSYS# Evaluation System

Evaluates: MAXM86161

- 7) The GUI launches with default settings as shown in [Figure 12](#). Note that during operation, hitting the “Reset” button restores the default settings.
- 8) Click on the Start button on the bottom right side to start the data acquisition.
- 9) Place a finger on the optical sensor.

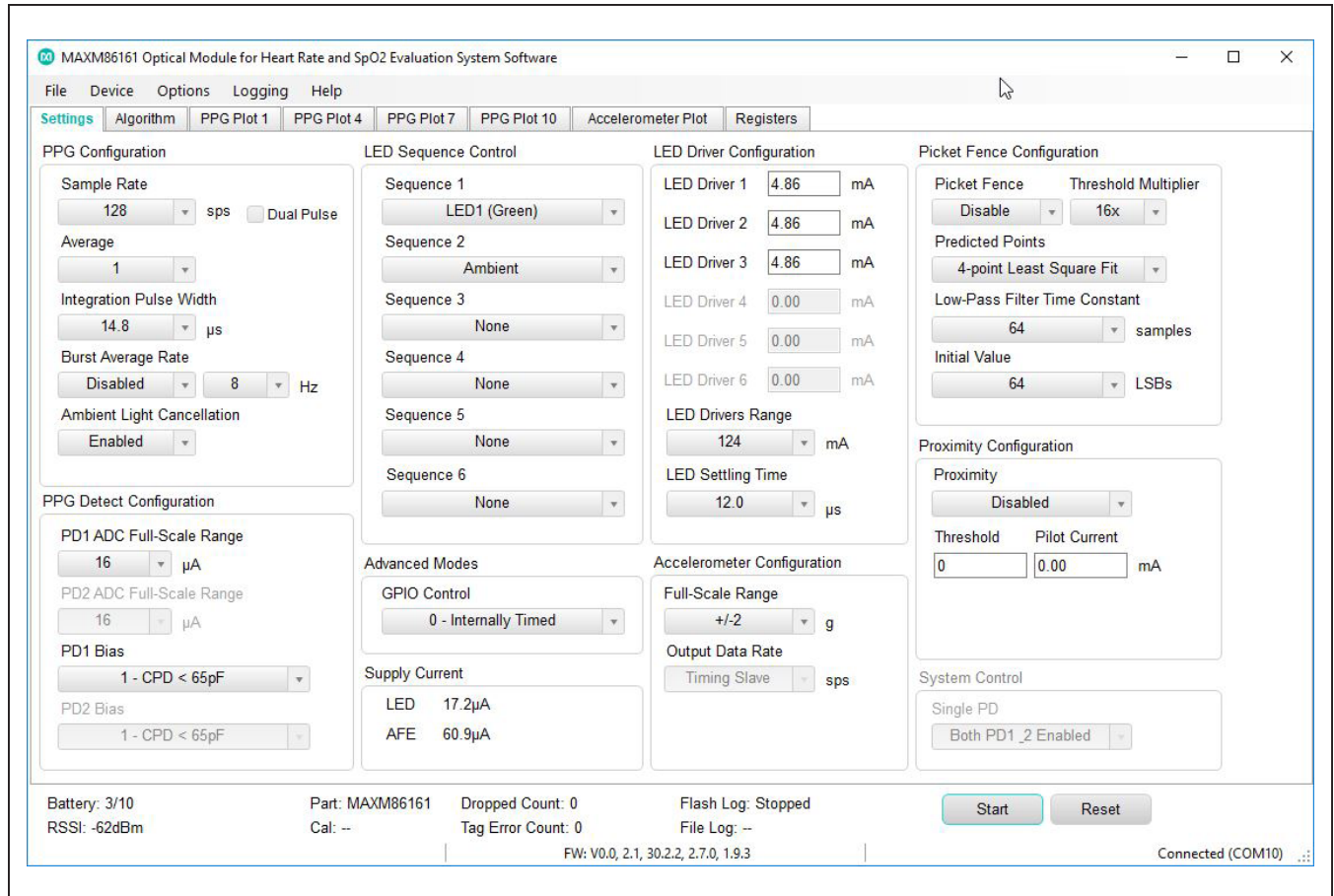

Figure 12. MAXM86161 EV System GUI (Default)

10) Verify the LEDs on the Micro PCB illuminate and the plots on the GUI stream with data and algorithm output as shown in [Figure 13](#) and [Figure 14](#).

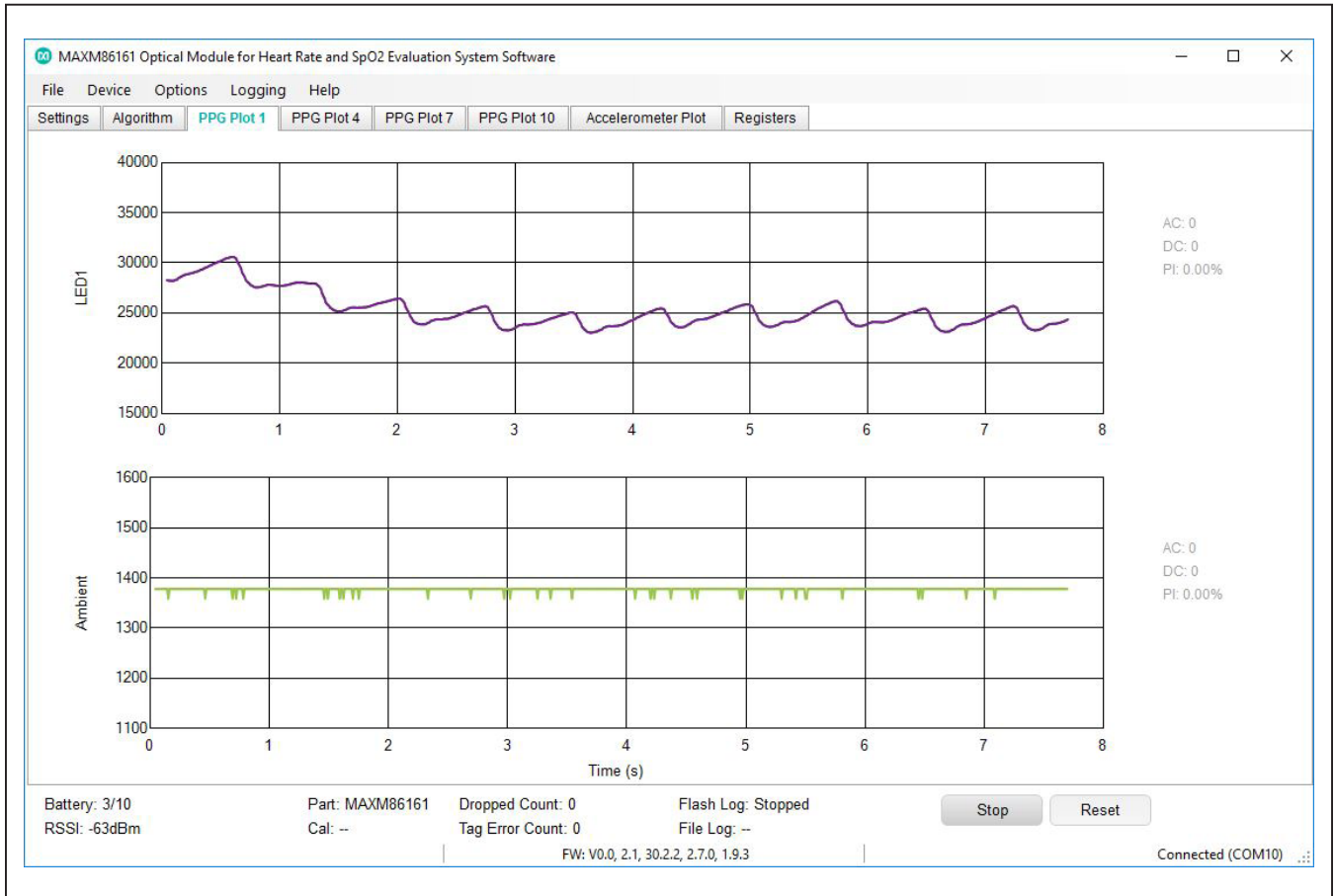

Figure 13. MAXM86161 EV System GUI (PPG Plots)

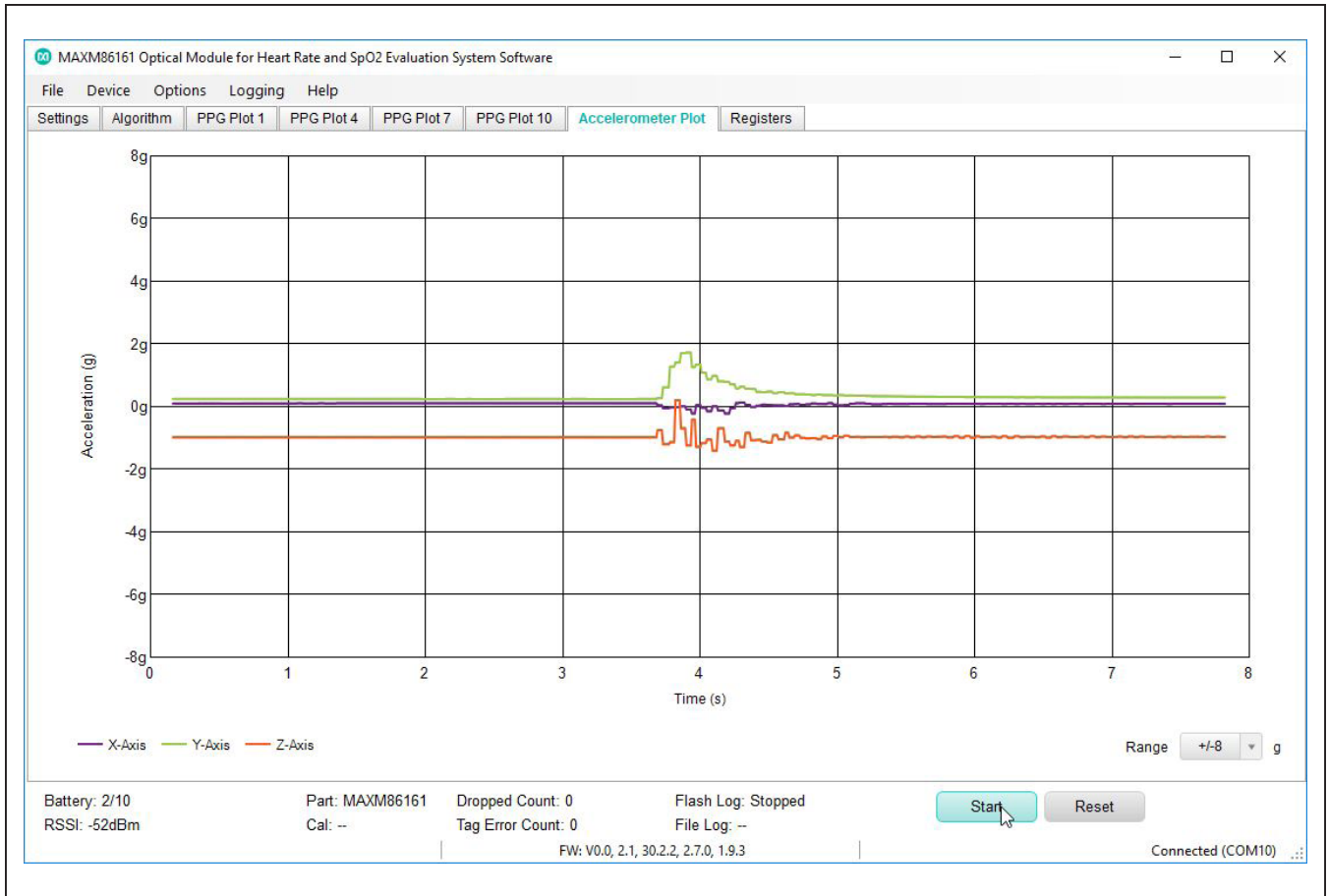

Figure 14. MAXM86161 EV System GUI (Accelerometer Plots)

Detailed Description of Software

The MAXM86161EVSYS# GUI has 5 drop-down lists (File, Device, Options, Logging, and Help) and 8 lower tabs that are used for configuring and viewing registers and data plots (Settings, Algorithm, PPG Plot 1, PPG Plot 4, PPG Plot 7, PPG Plot 10, Accelerometer Plot, and Registers).

Figure 15 below shows the 10 Configuration/Control Groups in the Settings tab. Setting descriptions of each group are given below.

The settings tab configures the MAXM86161 EV system allowing capture of raw optical and accelerometer data samples. The GUI further allows for both dynamic viewing and data logging through I2C or BLE data transfer protocols.

It should be noted that the GUI allows access to a subset of the MAXM86161 functionality. The MAXM86161 data sheet describes the complete set of functions supported by the device.

Start/Stop Button

The Start Monitor button is used to start data acquisition from the demo. The Start Monitor button is only effective when the EV system is connected and detected. Once Start has been pushed the Stop button appears, which can be used to stop the acquisition. Once the acquisition has started, all settings are locked. Terminate the acquisition to change any setting.

Reset Button

The Reset button clears out all register settings back to the programs default settings.

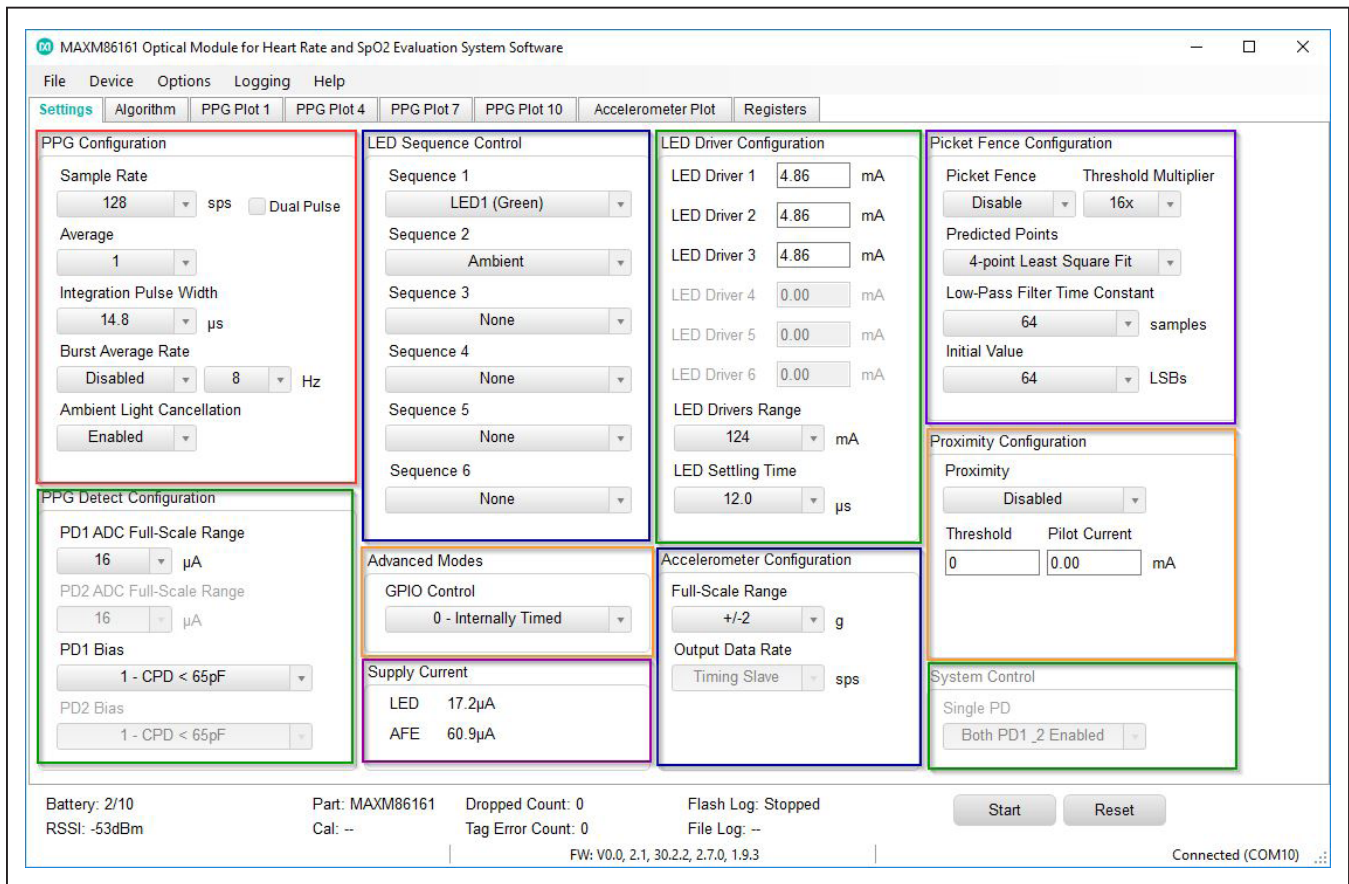

Figure 15. MAXM86161 EV System GUI: Settings Tab Descriptions

Settings Tab: PPG Configuration

Sample Rate

The sample rate can take on values between 8sps to 4096sps. The dual pulse mode option is a mode where two led exposures are used for each time slot and averaged to reduce noise. This helps achieve a higher SNR

[Table 1](#) shows the maximum supported sampling rates (in sps) for the MAXM86161 for the given number of exposure sequences and use of accelerometer. The maximum sample rate is limited by the BLE protocol, not the AFE itself.

For a given sample rate, the number listed can be increased to the next available MAXM86161 sample rate (i.e., 500sps → 512sps).

Sample Average

The MAXM86161 has the capability to sample averaging of 1 sample to 128 samples internally. While averaging increases the SNR of the system, it decreases the output data rate. For example, a 100sps sampling rate with a sample average of 4, reduces the output data rate to 25sps. This mode is particularly useful for subjects who have very low PPG signals. Averaging helps increase the SNR; thus, enabling customers to target populations with a lower perfusion index.

Integration Pulse Width

The pulse width setting adjusts the integration time of an exposure. The MAXM86161 supports exposure integration times of 14.8µs, 29.4µs, 58.7µs, and 117.3µs. The exposure pulse width is a critical parameter in any optical measurement. Longer exposures, yielding smaller effective noise bandwidths, result in higher SNR. Conversely, longer exposures produce higher power consumption compared to smaller exposures. This is primarily due to the longer “on” time of the LED(s) and ADC.

Table 1. MAXM86161 Max Sample Rates (sps)

ACCELEROMETER # OF SEQUENCES	WITH	WITHOUT
1	500	1000
2	250	500
3	125	250
4	125	125
5	125	125
6	62.5	125

The integration time is associated with a tradeoff between higher SNR and higher power.

Burst Average Rate

When Burst Mode is disabled, PPG data conversions are continuous at the sample rate defined by the PPG_SR Register. When Burst mode is enabled, a burst of PPG data conversions occurs at the sample rate defined by the sample rate in the PPG_SR register. The number of conversions in the burst is defined by the SMP_AVE register. Average data from the burst of data conversions is pushed to the FIFO at the rate of burst average rate. The burst repeats at the rate of 8Hz, 32Hz, 84Hz, or 256Hz can be configured in the burst average field. The burst average rate field defines the rate at which data is pushed into the FIFO. If the number of conversions cannot be accommodated, the device uses the next highest number of conversions. If the effective sample rate is too slow to accommodate the burst rate programmed, BURST_EN is automatically set to 0, and the device runs in continuous mode.

Ambient Light Cancellation

The on-chip ambient light cancellation incorporates a proprietary scheme to cancel the ambient light-generated photodiode current, allowing the sensor to work in high ambient light conditions.

Settings Tab: PPG Detect Configuration

PD1 ADC Full-Scale Range

The MAXM86161 PD1 channel has 4 full-scale ranges. These ranges are 4µA (4.096µA), 8µA (8.192µA), 16µA (16.384µA), and 32µA (32.768µA).

PD1 Bias

The PD1 BIAS values adjust the PD1_IN bias point impedance to ensure that the photodiode settles rapidly enough to support the sample timing. PDBIAS is configured for the embedded photodiode capacitance (C_{PD}). For the MAXM86161, set PD Bias to 1 for the photodiode installed in the integrated module.

Settings Tab: LED Sequence Control FIFO Time Slots

The LED Sequence Control specifies the data acquisition sequence that the internal state machine controller follows and where the converted data is mapped into the FIFO.

Each FIFO field can be applied to one measurement. Acquired data can be from LED1, LED2, or LED3 (optical exposure from LED1, LED2, or LED3) illuminated independently. The None option terminates the sequence.

The default exposure sequence is the entry in Sequence 1 (LED1 Green), Sequence 2 (LED2 IR), and Sequence 3 (LED3 Red). This sequence repeats for each sample instance. Note that there are 6 sequence choices and, if they are available in the device, two photodiode selections that can potentially create 12 plots. These plots are shown in groups of three and can be viewed under the following tab names: PPG Plot 1, PPG Plot 4, PPG Plot 7, and PPG Plot 10.

Refer to the MAXM86161 data sheet under the *FIFO Configuration* section for details.

Settings Tab: LED Driver Configuration

Each of the three LED drivers has a Range and Peak LED current setting. There are 4 full-scale range settings 31mA, 62mA, 93mA, and 124mA. Each range has an 8-bit current source DAC. The Peak LED Current box allows for an actual current to be entered. The nearest available DAC current is selected and displayed in the field.

6 LED drivers are shown, but only the first three are available for configuration.

LED Settling Time

The LED settling time is the time prior to the start of integration (pulse-width setting) that the LED is turned on. There are four settlings, 12 μ s, 8 μ s, 6 μ s, and 4 μ s. This time is necessary to allow the LED driver to settle before integrating the exposure photo current.

Settings Tab: Advanced Modes

GPIO Control offers two usable configurations: 2-GPIO1 Sample Clock and 10-MAX86140/MAX861411 One Shot. These configurations allow a user two methods of synchronizing data from the accelerometer and the MAXM86161.

Settings Tab: Accelerometer Configuration

The on-board accelerometer can be enabled or disabled by using the GUI. Supported accelerometer full-scale ranges are $\pm 2g$, $\pm 4g$, and $\pm 8g$.

When the GPIO Control is set in either Configuration 2 or 10, the accelerometer output rate can be set. The set values are 12.5Hz, 25Hz, 50Hz, 100Hz, 200Hz, 400Hz, 800Hz, or 1600Hz.

Settings Tab: Proximity Configuration

The optical controller also includes an optical proximity function, which could significantly reduce energy consumption and extend battery life when the sensor is not in contact with the skin.

Refer to the MAXM86161 data sheet in the *Proximity Mode Function* section for details.

Settings Tab: Picket Fence Configuration

Under typical situations, the rate of change of ambient light is such that the ambient signal level during exposure can be accurately predicted and high levels of ambient rejection are obtained. However, it is possible to have situations where the ambient light level changes extremely rapidly. For example, when a car with direct sunlight exposure passes under a bridge and into a dark shadow. In these situations, it is possible for the on-chip ambient light correction (ALC) circuit to fail and produce an erroneous estimation of the ambient light during the exposure interval. The optical controller has a built-in algorithm called the picket fence function that can correct for these extreme conditions.

Refer to the MAXM86161 data sheet under *Picket Fence Detect-and-Replace Function* section for details.

Settings Tab: Supply Current

The supply current window shows the average current being drawn from the AFE and the LEDs independent of each other.

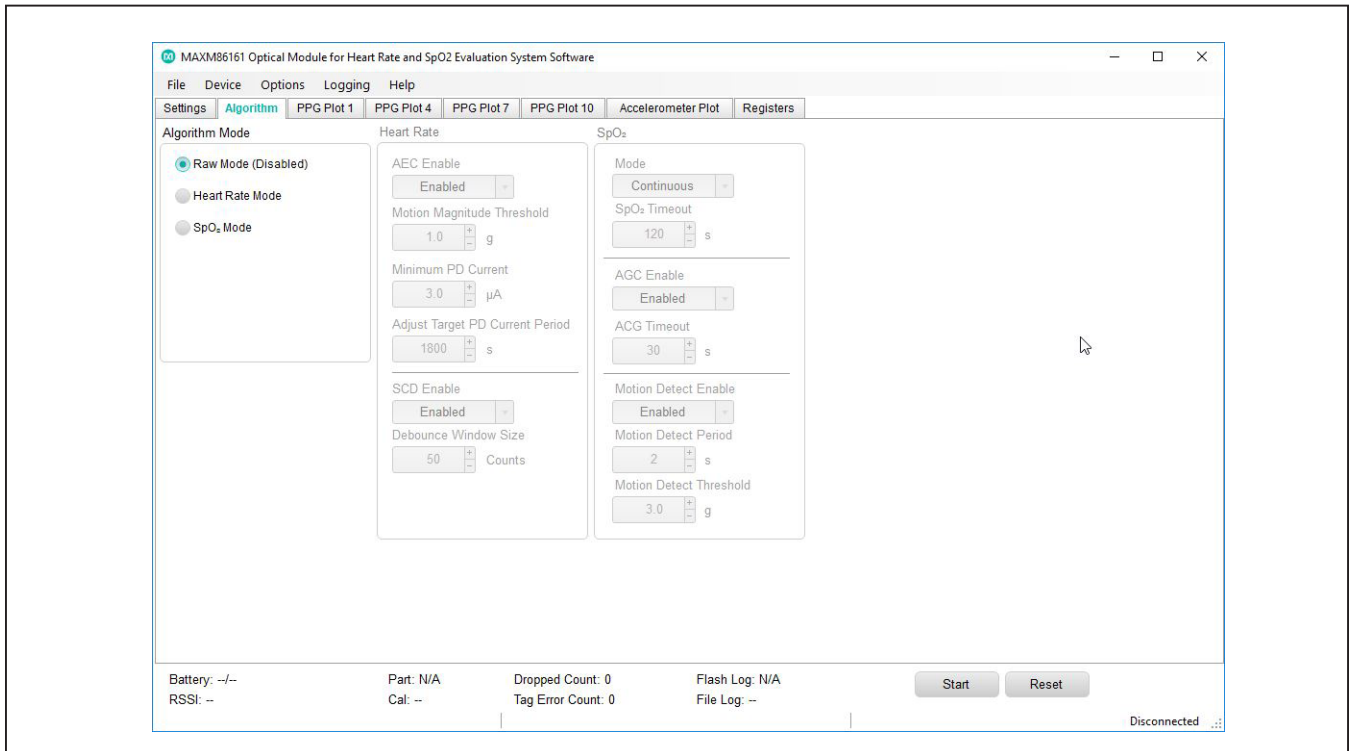

Figure 16. MAXM86161 EV System GUI: Available Algorithm Modes

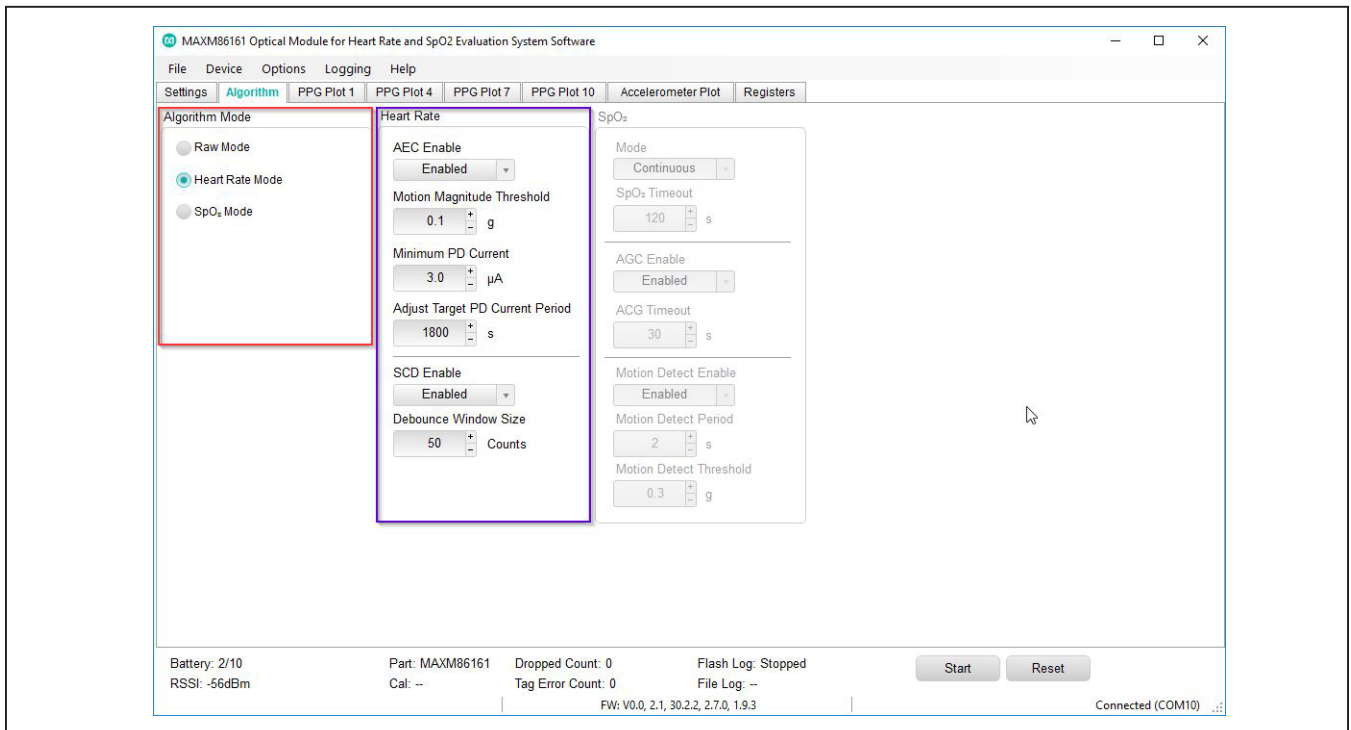

Figure 17a. MAXM86161 EV System GUI: Algorithm Tab Descriptions

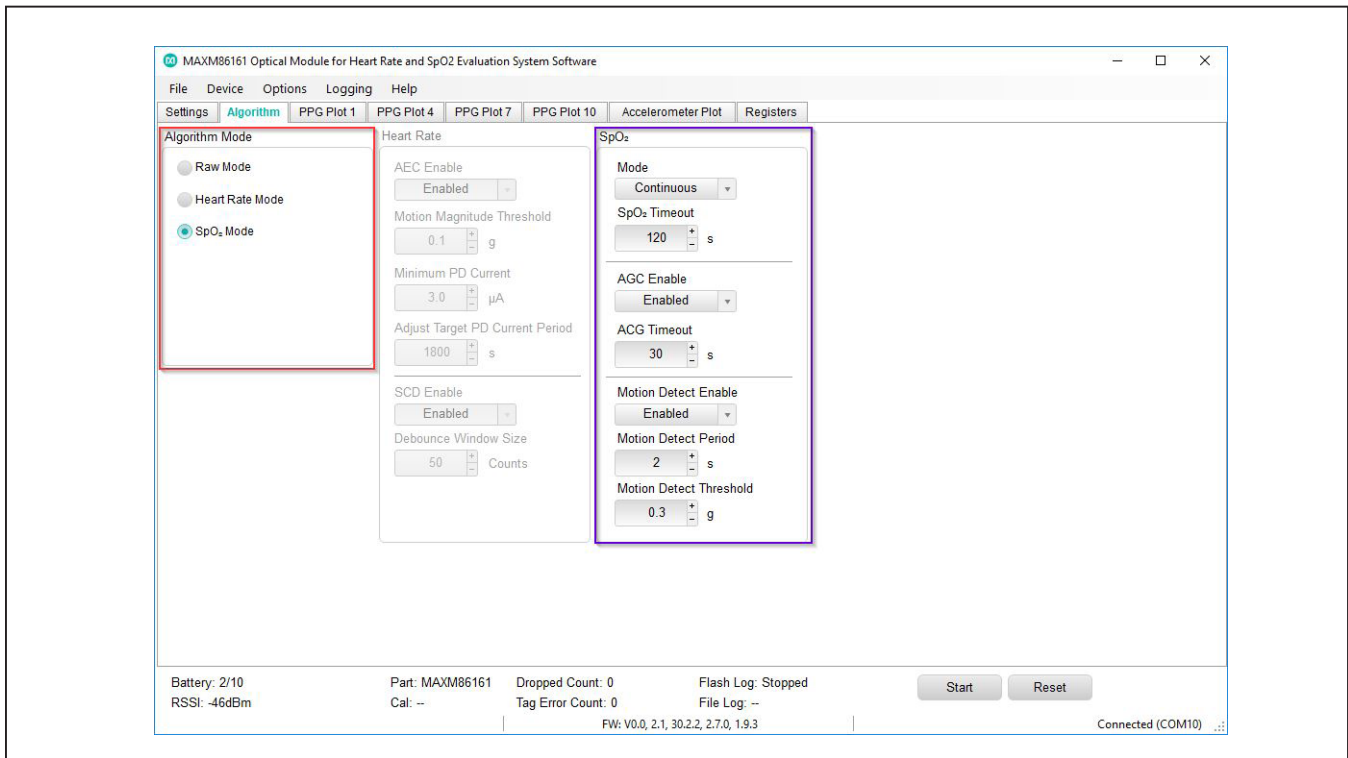

Figure 17b. MAXM86161 EV System GUI: Algorithm Tab Descriptions

Algorithm Tab: AlgorithmMode

Under the Algorithm tab, there are three selectable modes available: 1) Raw Mode (default), 2) Heart Rate Mode, and 3) SpO₂ Mode (Figure 16). While in Raw Mode, the algorithm configuration windows are not active. When a user selects an available algorithm mode (i.e., Heart Rate Mode or SpO₂ Mode), the corresponding configuration window is highlighted and allows the user the ability to modify the settings.

Algorithm Tab: Heart Rate

Refer to [Figure 17a](#).

AEC Enable

This configuration box allows the automatic exposure control (AEC) to be Enabled or Disabled. This algorithm feature controls the LED current, photodiode current, integration time, and number of sample averages to increase SNR while maintaining minimal power consumption.

Motion Magnitude Threshold

This configuration box allows a user to select the motion detect threshold level from a range of 0g to 8g of linear acceleration in 0.1g steps. The default value is 0.1g.

Minimum PD Current

This configuration box allows a user to select the Minimum Photodiode (PD) Current level from a range of 0µA to 32µA in 0.1µA steps. The default value is 3.0µA.

Adjust Target PD Current Period

This configuration box allows a user to select the target photodiode (PD) current period level from a range of 0s to 65,535s in 1s steps. The default value is 1800s.

SCD

This configuration box allows a user to Enable or Disable the skin contact detection (SCD) feature and to set the SCD Debounce Window Size.

MAXM86161EVSYS# Evaluation System

Evaluates: MAXM86161

Debounce Window Size

This configuration box allows a user to select the debounce window size level from a range of 0 counts to 65,535 counts in 1count steps. The default value is 50 counts.

Algorithm Tab: SpO2

Refer to [Figure 17b](#).

Mode

This configuration box allows a user to select the operational mode. The following modes are available:

- Continuous
- One-Shot
- Calibration

SpO2 Timeout

This configuration box allows a user to select the SpO2 timeout level from a range of 0s to 255s in 1s steps. The default value is 120s.

AGC Enable

This configuration box allows a user to enable or disable the automatic gain control (AGC).

AGC Timeout

This configuration box allows a user to select the AGC timeout level from a range of 0s to 255s in 1s steps. The default value is 30s.

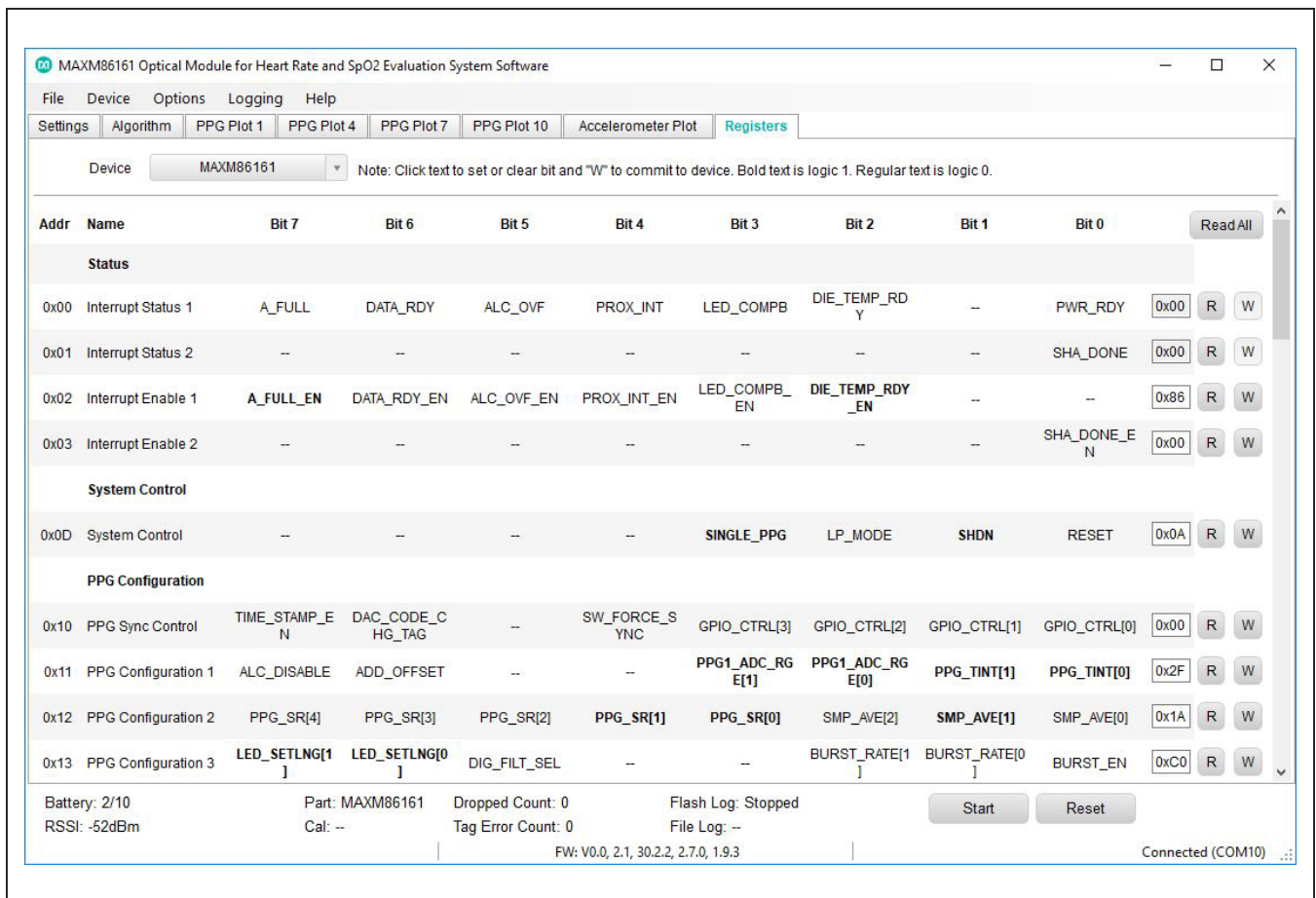

Figure 18. Register Map Access

Motion Detect Enable

This configuration box allows a user to enable or disable the motion detection feature.

Motion Detect Period

This configuration box allows a user to select the motion detect period level from a range of 0s to 16535s in 1s steps. The default value is 2s.

Motion Detect Threshold

This configuration box allows a user to select the motion detect threshold level from a range of 0g to 8g linear acceleration in 0.1g steps. The default value is 0.1g.

Registers Tab: Register Map Access

Register Map access is provided to allow a user the ability to modify all available device settings if desired. The GUI provides a subset of these, whereas the Register Tab provides the superset.

Register Map Access

Under the Register Tab the user can access the sensor register map as shown in [Figure 18](#). Press Read All to read all the register value currently in configured in the Optical AFE. Bolded font bits are logic one. Normal font bits are logic zero. Click on the bits to toggle their value and click on W to write the value to the device. The register value does not change until W is clicked. Click R to read the register value to verify the write.

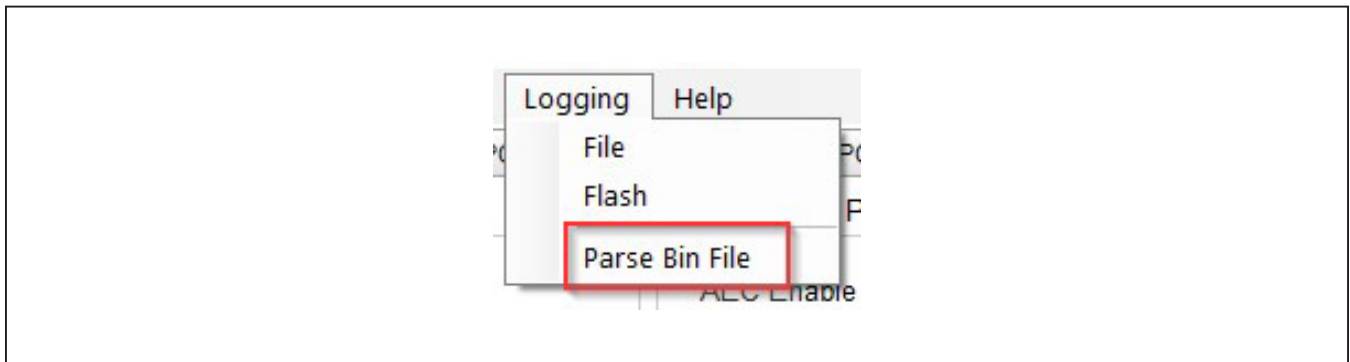

Figure 19. MAXM86161 EV System GUI: Bin-to-CSV Data File Format Conversion Option

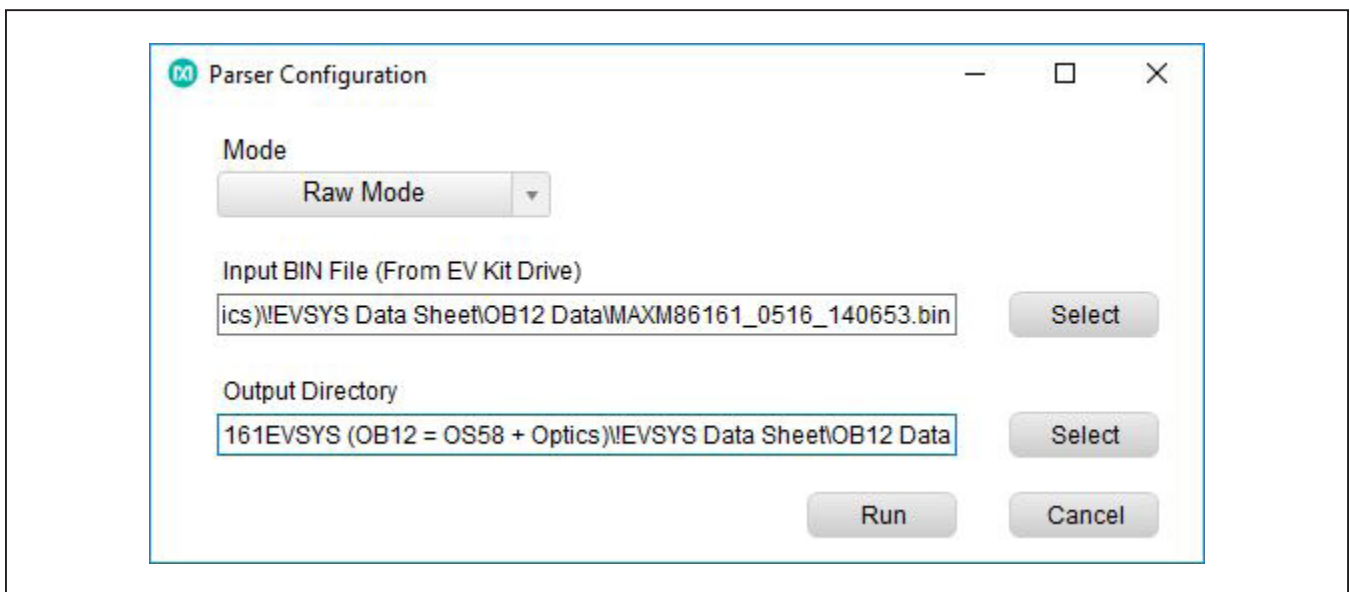

Figure 20. Parser Configuration

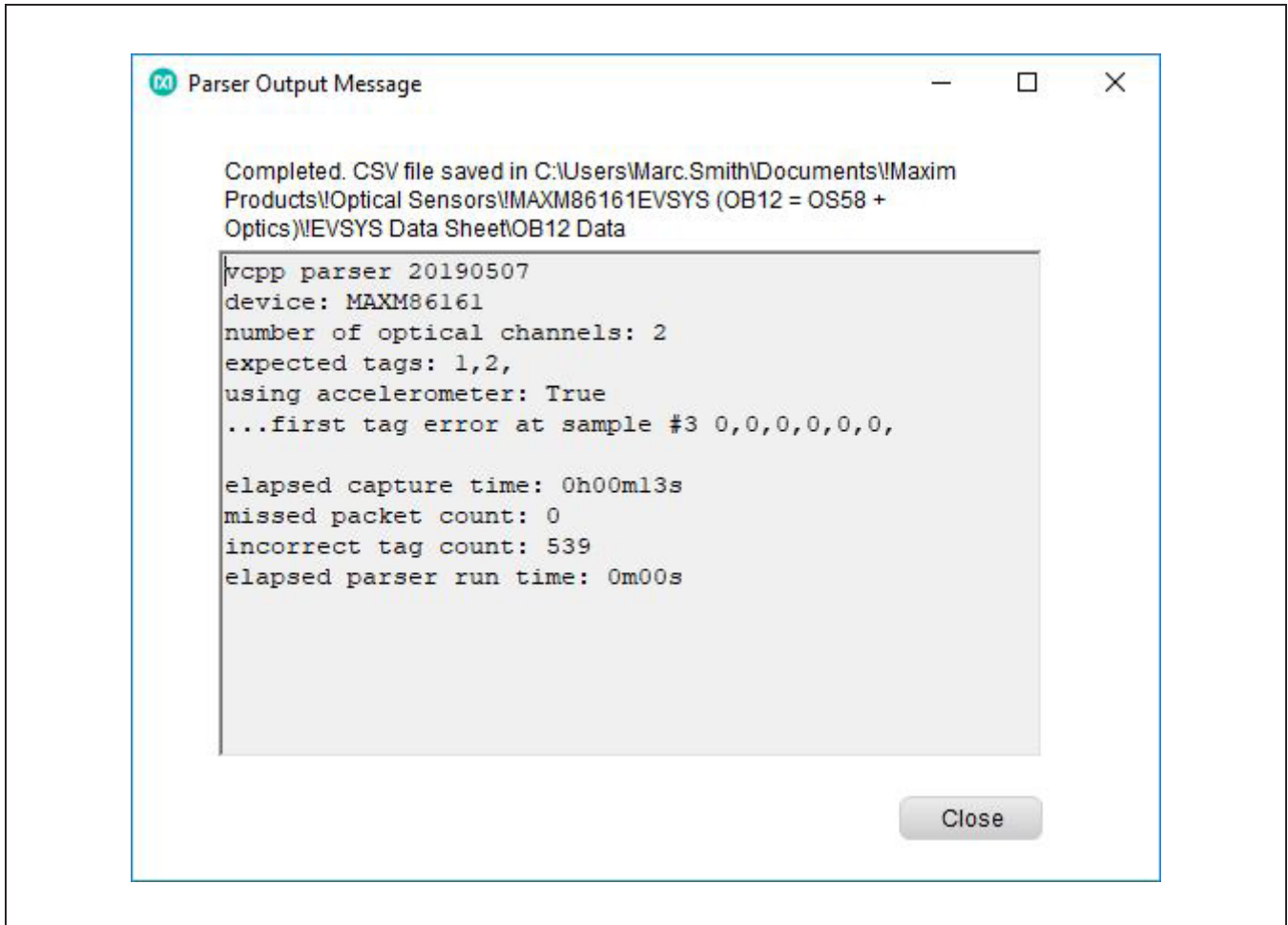

Figure 21. Parser Completed Message Window

Data Logging: Setup

Raw optical and accelerometer data can be logged from the Logging pull-down menu item. There are two options available: Data saved to file or in the flash. When “file” data logging is selected, the GUI asks for a folder location where the logging file is saved. Create a new folder or accept the default. Data logging starts on the next Start button and continues until the Stop button is pressed. The final file write is only done when the File pull-down menu item is accessed and the data-logging button is pressed.

Flash logging allows raw sensor data to be stored to the integrated 32MB flash memory chip in a binary file format. The max duration for flash logging is dependent on sample rate, number of optical channels, and use of the accelerometer.

The GUI enables/disables flash logging. The GUI can be disconnected while flash logging, allowing for remote operation (PPG Plots not available). Preparing the flash memory can take up to 30s after enabling. If the flash memory fills or battery power drops too low, flash logging automatically stops and the file closes. Only one file can be saved at a time. The file must be downloaded since it is erased on the next log request.

If a log has completed, a binary file is found on the device. The binary log file must be downloaded using the USB-C cable; it cannot be downloaded through Bluetooth. When the device is plugged into the PC, it enumerates as a USB mass storage device. However, the file can only be copied from this device. No other operations (such as deleting

MAXM86161reg0x0D	MAXM86161reg0x10	MAXM86161reg0x11	MAXM86161reg0x12	MAXM86161reg0x13	MAXM86161reg0x14	MAXM86161reg0x15	MAXM86161reg0x16	MAXM86161reg0x20
MAXM86161reg0x2A	MAXM86161reg0x2B	MAXM86161reg0xFE	MAXM86161reg0xFF	KX122reg0x18	KX122reg0x1B	0	0	0
0x02	0x00	0x28	0x70	0xc0	0x00	0x11	0x42	0x91
0x3f	0x3f	0x09	0x36	0x00	0x01	0x00	0x00	0x00
start time	1.55804E+12							
expected tags	1	2						
timestamp	sampleNum	tagLEDC1	tagLEDC2	LEDC1	LEDC2	ACCX	ACCY	ACCZ
1.55804E+12	1	0	0	1958	7672	1013	3	51
1.55804E+12	2	0	0	2038	7602	1013	3	51
1.55804E+12	3	0	0	2087	7569	1013	3	51
1.55804E+12	4	0	0	2077	7596	1013	3	51
1.55804E+12	5	0	0	2008	7550	1013	3	51
1.55804E+12	6	0	0	2037	7488	1013	3	51
1.55804E+12	7	0	0	1985	7527	1013	3	51
1.55804E+12	8	0	0	1935	7502	1013	3	51
1.55804E+12	9	0	0	2038	7506	1013	3	51
1.55804E+12	10	0	0	2004	7558	1013	3	51
1.55804E+12	11	0	0	1965	7569	1013	3	52
1.55804E+12	12	0	0	2016	7614	1013	3	52
1.55804E+12	13	0	0	1984	7694	1013	3	52

Figure 22. Output CSV File Example (First 9 columns).

MAXM86161reg0x21	MAXM86161reg0x22	MAXM86161reg0x23	MAXM86161reg0x24	MAXM86161reg0x25	MAXM86161reg0x26	MAXM86161reg0x27	MAXM86161reg0x28	MAXM86161reg0x29
0 RTCpreScale	WallClock_B3	WallClock_B2	WallClock_B1	WallClock_B0	UseAcc	WallClock_B5	WallClock_B4	
0x00	0x00	0x0a	0x0a	0x0a	0x00	0x00	0x00	0x00
0x00	0x1f	0xc2	0x78	0x21	0x9b	0x01	0x01	0x6a
temperature	RTC	sensor	regAddr	val	I2Caddr			

Figure 23. Output CSV File Example (Last 9 columns).

or saving other files) works on this device. The user can copy the binary (*.bin) file to a local PC.

Data Logging: Parsing

The GUI S/W provides a BIN-to-CSV file format conversion function, which allows the user to create a CSV file on the PC. This can be implemented by first selecting the “Logging” drop-down list, and then selecting the “Parse Bin File” button (Figure 19).

A Parser Configuration window opens next as shown in Figure 20. The user needs to select the input bin file and the Output Directory location for the converted CSV file. Next, select “Run” to initiate the conversion. Once the

Parser has completed a message appears as shown in Figure 21.

Data Logging: Output File Format

Refer to Figure 22 and Figure 23 below for an output file example. The output file format is:

Lines 1 and 2: The MAXM86141 and accelerometer register addresses whose values are listed in lines 3 and 4. ('0' denotes an unused field 2)

Lines 3 and 4: The values of the registers listed in lines 1 and 2.

Line 5: The start time of the capture in milliseconds.

Line 6: A list of the expected tags based on the number of LED channels selected. Use this to compare to each sample tag to detect any errors.

Line 7: A column header denoting the timestamp, sample number, tags, LED channels, accelerometer axes, temperature, total RTC ticks, sensor, regAddr, val, and I2Caddr.

Note: The tags/LED channels/accelerometer axes columns depend on the system configuration (i.e., 1 LED channel and no accelerometer give a different header than 2 LED channels with accelerometer).

Lines 8 through n-4: Raw data.

Line n-3: The stop time of the capture.

Line n-2: The elapsed capture time.

Line n-1: The number of dropped packets.

Line n: The number of incorrect tags.

Detailed Description of Hardware

Status LED Indicators

The MAXSensorBLE onboard LEDs are used as status indicators.

LED Green

Toggling (1Hz 50% duty cycle) = BLE advertising

Toggling (1Hz 10% duty cycle) = BLE connected

LED Red

USB-C cable connected to the charger

On = charging

Off = charge complete

Flash Logging

On = busy preparing the flash memory or flash memory is full

Toggling (synchronously with the green LED) = logging

Off = not logging

Note: Flash logging indication takes precedence over the charging indication. I.e., if the device is plugged into a charger, the red LED indicates charge status. If flash logging is enabled while plugged into the charger, the red LED indicates flash log status.

Power Switch

Press the power switch (SW) to turn on/off the device. When powered on, the green LED toggles per the LED indicator section. When powered off, the green LED goes out. The red LED can light temporarily, indicating that the flash log is closing. Plugging in the USB-C cable also powers up the device.

Battery/Charging

Use the USB-C cable to charge the integrated single-cell LiPo battery. The integrated PMIC initiates and stops charging automatically. Charge status is indicated through the red LED and GUI.

MAXM86161EVSYS# Evaluation System

Evaluates: MAXM86161

Component List MAXM86161 EV System

PART	QTY	DESCRIPTION
MAXM86161OSBFLEX	1	Optical Sensor Flex-Rigid Board
MAXSENSORBLE	1	MaxSensorBLE Board; μ C PCB
101181XX-000XXX	1	USB-C to USB-A Cable, 3ft
LP-401230	1	Battery/Conn Assy; Li-Polymer; 3.7V; 105mAh; JST PH-2P Connector, PCM

PART	QTY	DESCRIPTION
MAXM86161ADPTR AND MAX32630FTHR	1	Assembly; Programmer; MAXM86161ADPTR and MAX32630FTHR
MAXREFDES100HDK	1	DR_MBHDK_APPS; Programming Board
AK67421-1-R	2	USB 2.0; USB B Micro to USB A Male

Ordering Information

PART	TYPE
MAXM86161EVSYS#	EV System

#Denotes a RoHS-compliant device that may include lead(Pb) that is exempt under the RoHS requirements.

MAXM86161EVSYS# EV System Bill of Materials

Other documentation to use this EV System is available at the [MAXM86161EVSYS# EV System Design Resources](#) tab and at the [MAXREFDES100HDK](#) website.

MAXM86161OSBFLEX Bill of Materials

ITEM	REF_DES	DN/DNP	QTY	MFG PART #	MANUFACTURER	VALUE	DESCRIPTION	COMMENTS
1	C1, C2, C5-C7	-	5	GRM033R61A105ME15	MURATA	1UF	CAPACITOR; SMT (0201); CERAMIC CHIP; 1UF; 10V; TOL=20%; TG=-55 DEGC TO +85 DEGC; TC=X5R	
2	C3, C4, C8	-	3	04026D226MAT2A; CL05A226MQ5QUNC	AVX;SAMSUNG	22UF	CAPACITOR; SMT (0402); CERAMIC CHIP; 22UF; 6.3V; TOL=20%; TG=-55 DEGC TO +85 DEGC; TC=X5R	
3	R1-R4, R2B, R3B, R6-R11	-	12	CRCW02010000ZS; ERJ-1GN0R00	VISHAY DALE; PANASONIC	0	RESISTOR; 0201; 0 OHM; 0%; JUMPER; 0.05W; THICK FILM	
4	R12	-	1	CRCW020110K0FK	VISHAY DALE	10K	RESISTOR; 0201; 10K OHM; 1%; 100PPM; 0.05W; THICK FILM	
5	R13, R14	-	2	ERJ-1GNJ103	PANASONIC	10K	RESISTOR; 0201; 10K OHM; 5%; 200PPM; 0.05W; THICK FILM	
6	U1	-	1	MAXM86161	MAXIM	MAXM86161	EVKIT PART - IC; MOD; INTEGRATED OPTICAL MODULE FOR IN-EAR HR AND SPO2; OLGA14	
7	U2	-	1	MAX32664GWEZ+	MAXIM	MAX32664GWEZ+	EVKIT PART - IC; MAX32664GWEZ+; ULTRA-LOW POWER BIOMETRIC SENSOR HUB; WLP16; PACKAGE OUTLINE DRAWING NUMBER: 21-100241; PACKAGE CODE: W161K1+1	
8	U3	-	1	KX122-1037	KIONIX	KX122-1037	IC; SNSR; +/-2G/4G/8G TRI-AXIS DIGITAL ACCELEROMETER; LGA12	
9	Y1	-	1	CM1610H32768DZB	CITIZEN	32.7680KHZ	CRYSTAL; SMT 1.6MMX1MM; 6PF; 32.7680KHZ; +/-20PPM	
10	PCB	-	1	MAXM86161OSBFLEX	MAXIM	PCB	PCB:MAXM86161OSBFLEX	
11	R1A-R3A, R1B, R5	DNP	0	CRCW02010000ZS; ERJ-1GN0R00	VISHAY DALE; PANASONIC	0	RESISTOR; 0201; 0 OHM; 0%; JUMPER; 0.05W; THICK FILM	
TOTAL			28					

MAXM86161EVSYS# Evaluation System

Evaluates: MAXM86161

MAXM86161EVSYS# EV System Bill of Materials (continued)

Other documentation to use this EV System is available at the [MAXM86161EVSYS# EV System Design Resources](#) tab and at the [MAXREFDES100HDK](#) website.

MAXSensorBLE Bill of Materials

ITEM	REF DES	DNI/DNP	QTY	MFG PART #	MANUFACTURER	VALUE	DESCRIPTION	COMMENTS
1	A1	-	1	2450AT18A100	JOHANSON TECHNOLOGY	2450AT18A100	ANTENNA; 2450AT SERIES; BOARDMOUNT; MINI 2.45 GHZ ANTENNA; 2450MHZ	
2	BAT	-	1	B2B-PH-K-S(LF)(SN)	JST MANUFACTURING	B2B-PH-K-S(LF)(SN)	CONNECTOR; MALE; THROUGH HOLE; PH CONNECTOR; 2MM PITCH; SHROUDED HEADER; STRAIGHT; 2PINS	
3	C1, C22, C26, C30-C37	-	11	GRM033R61A104KE15; LMK063B1104KP	MURATA;TAIYO YUDEN	0.1UF	CAPACITOR; SMT (0201); CERAMIC CHIP; 0.1UF; 10V; TOL=10%; MODEL=; TG=-55 DEGC TO +125 DEGC; TC=X5R	
4	C2, C15, C25, C38-C43	-	9	GRM033R61A105ME15	MURATA	1UF	CAPACITOR; SMT (0201); CERAMIC CHIP; 1UF; 10V; TOL=20%; TG=-55 DEGC TO +85 DEGC; TC=X5R	
5	C3, C4, C8, C9, C12, C16, C27	-	7	C1005X5R1A475M050BC	TDK	4.7UF	CAPACITOR; SMT (0402); CERAMIC CHIP; 4.7UF; 10V; TOL=20%; MODEL=C SERIES; TG=-55 DEGC TO +85 DEGC; TC=X5R	
6	C5-C7, C10, C13, C14, C47	-	7	GRM155R60J226ME11	MURATA	22UF	CAPACITOR; SMT (0402); CERAMIC CHIP; 22UF; 6.3V; TOL=20%; TC=X5R	
7	C19	-	1	GJM0335C1E1R0WB01	MURATA	1PF	CAPACITOR; SMT (0201); CERAMIC CHIP; 1PF; 25V; TOL=0.05PF; TG=-55 DEGC TO +125 DEGC; TC=C0G	
8	C20, C21, C28, C29, C45, C46, Z44	-	7	GRM0335C1H120GA01	MURATA	12PF	CAPACITOR; SMT (0201); CERAMIC CHIP; 12PF; 50V; TOL=2%; TG=-55 DEGC TO +125 DEGC; TC=C0G	
9	C23, C24	-	2	GRM0335C1H101JA01	MURATA	100PF	CAPACITOR; SMT (0201); CERAMIC CHIP; 100PF; 50V; TOL=5%; TG=-55 DEGC TO +125 DEGC; TC=C0G	
10	CN1	-	1	DX07S024JJ3	JAE ELECTRONIC INDUSTRY	DX07S024JJ3	CONNECTOR; FEMALE; SMT; USB TYPE-C CONNECTOR; DX07 SERIES RECEPTACLE; RIGHT ANGLE; 24PINS	
11	DS1, DS2	-	2	SML-P11UTT86	ROHM	SML-P11UTT86	DIODE; LED; SMT; PIV=1.8V; IF=0.02A	
12	J3	-	1	5035662500	MOLEX	5035662500	CONNECTOR; FEMALE; SMT; EASY-ON TYPE HOUSING ASSEMBLY; RIGHT ANGLE; 25PINS	
13	L1, L2	-	2	DFM18PAN2R2MG0L	MURATA	2.2UH	INDUCTOR; SMT (0603); CERAMIC CHIP; 2.2UH; TOL=+/-20%; 1.1A	
14	L3	-	1	DFE201610E-4R7M=P2	MURATA	4.7UH	INDUCTOR; SMT (2016); METAL ALLOY CHIP; 4.7UH; TOL=+/-20%; 1.3A	
15	L4	-	1	LQP03HQ3N3B02	MURATA	3.3NH	INDUCTOR; SMT (0201); FILM TYPE; 3.3NH; TOL=+/-0.1nH; 0.5A	
16	LED	-	1	SML-LX0404SIUPGUSB	LUMEX OPTOCOMPONENTS INC	SML-LX0404SIUPGUSB	DIODE; LED; SML; FULL COLOR; WATER CLEAR LENS; RED-GREEN-BLUE; SMT; VF=2.95V; IF=0.1A	
17	R2, R3, R11, R15, R24, R27-R31, R34	-	11	ERJ-2GE0R00X	PANASONIC	0	RESISTOR; 0402; 0 OHM; 0%; JUMPER; 0.10W; THICK FILM	
18	R5, R9	-	2	ERJ-1GEF1002C	PANASONIC	10K	RESISTOR; 0201; 10K OHM; 1%; 200PPM; 0.05W; THICK FILM	
19	R6, R7, R16, R17, R23, R25, R26	-	7	ERJ-1GEF4701C	PANASONIC	4.7K	RESISTOR; 0201; 4.7K OHM; 1%; 100PPM; 0.05W; THICK FILM 3-LAYER ELECTRODE	
20	R8	-	1	ERJ-1GEF3902C	PANASONIC	39K	RESISTOR; 0201; 39K OHM; 1%; 100PPM; 0.05W; THICK FILM 3-LAYER ELECTRODE	
21	R10	-	1	NCP15XH103F03RC	MURATA	10K	THERMISTOR; SMT (0402); THICK FILM (NICKEL PLATED); 10K; TOL=+/-1%	
22	R13	-	1	ERJ-1GEF2613C	PANASONIC	261K	RESISTOR; 0201; 261K OHM; 1%; 200PPM; 0.05W; THICK FILM	
23	R14	-	1	CRCW0201100KFK	VISHAY DALE	100K	RESISTOR; 0201; 100K OHM; 1%; 100PPM; 0.05W; THICK FILM	
24	R18, R19	-	2	ERJ-1GEF2000C	PANASONIC	200	RESISTOR; 0201; 200 OHM; 1%; 200PPM; 0.05W; THICK FILM	
25	RA1-RA4	-	4	ERJ-1GEF33R0C	PANASONIC	33	RESISTOR; 0201; 33 OHM; 1%; 100PPM; 0.05W; THICK FILM 3-LAYER ELECTRODE	
26	SW	-	1	EVP-AWCD2A	PANASONIC	EVP-AWCD2A	SWITCH; SPST; SMT; STRAIGHT; 15V; 0.02A; EVP-AW SERIES	
27	U1	-	1	MAX20303	MAXIM	MAXIM SENSOR PLATFORM 2	EVKIT PART- IC; WEARABLE POWER MANAGEMENT SOLUTION; PACKAGE OUTLINE; WLP 56 PINS; 0.5MM PITCH; PKG. CODE: W563A4+1; PKG. OUTLINE: 21-100104;	
28	U2	-	1	NRF52832-CIAA	NORDIC SEMICONDUCTOR	NRF52832-CIAA	IC; SOC; MULTIPROTOCOL BLUETOOTH LOW ENERGY; ANT; 2.4GHZ RF SOC; WLCSP50	
29	U3-U6, U9	-	5	MAX14689EWL+	MAXIM	MAX14689EWL+	IC; ASW; 0.125A; FREQUENCY-SELECTABLE; SWITCHED-CAPACITOR VOLTAGE CONVERTER; WLP9 1.2X1.2	
30	U7	-	1	IP4221CZ6-S	NXP	IP4221CZ6-S	IC; PROT; ESD PROTECTION FOR HIGH-SPEED INTERFACE; XSON6	
31	U8	-	1	S25FS256SAGNF1001	SPANSION	S25FS256SAGNF1001	IC; MMRY; MIRRORBIT FLASH; NON-VOLATILE MEMORY; 1.8V SINGLE SUPPLY WITH CMOS I/O; SERIAL PERIPHERAL INTERFACE WITH MULTI-I/O; WSON8-EP	
32	U10, U11	-	2	MAX9062EBS+G45	MAXIM	MAX9062EBS+G45	IC; COMP; ULTRA-SMALL; LOW-POWER SINGLE COMPARATOR; UCSP4	
33	U12	-	1	MAX32620IWG+	MAXIM	MAX32620IWG+	IC; UCON; HIGH-PERFORMANCE; ULTRA-LOW POWER CORTEX-M4F MICROCONTROLLER FOR RECHARGEABLE DEVICES; WLP81	
34	U13	-	1	74AUP1G97GF	NXP	74AUP1G97GF	IC; LOGC; LOW-POWER CONFIGURABLE MULTIPLE FUNCTION GATE; XSON8	
35	U29	-	1	MAX1819EBL50+	MAXIM	MAX1819EBL50+	IC; VREG; 500MA LOW-DROPOUT LINEAR REGULATOR IN UCSP; UCSP6	
36	X2, Y2	-	2	ECS-.327-6-12	ECS INC	32.768KHZ	CRYSTAL; SMT 2.0 MM X 1.2 MM; 6PF; 32.768KHZ; +/-20PPM; -0.03PPM/DEGC	
37	Y1	-	1	US3200005Z	PERICOM SEMICONDUCTOR	32MHZ	CRYSTAL; SMT 1.6 MM X 1.2MM; 8PF; 32MHZ; +/-10PPM; +/-10PPM	
38	PCB	-	1	MAXSENSORBLE	MAXIM	PCB	PCB;MAXSENSORBLE	
39	MISC1	DNI	1	101181XX-000XXX	N/A	101181XX-000XXX	CONNECTOR; MALE; PALETTE SERIES 3.0 USB-C TO USB-A; 3FT BLACK	
40	R1, R4, R12, R20-R22, R32, R33	DNP	0	ERJ-2GE0R00X	PANASONIC	0	RESISTOR; 0402; 0 OHM; 0%; JUMPER; 0.10W; THICK FILM	
41	Z17	DNP	0	GJM0335C1E1R0WB01	MURATA	1PF	CAPACITOR; SMT (0201); CERAMIC CHIP; 1PF; 25V; TOL=0.05PF; TG=-55 DEGC TO +125 DEGC; TC=C0G	
42	Z18	DNP	0	250R05L1R8AV4	JOHANSON TECHNOLOGY	1.8PF	CAPACITOR; SMT (0201); MICROWAVE; 1.8PF; 25V; TOL=0.05PF; TG=-55 DEGC TO +125 DEGC; TC=C0G	
43	Jan-36	DNP	0	N/A	N/A	N/A	TEST POINT; PAD DIA=0.762MM; BOARD HOLE=0.381MM	
TOTAL			105					

MAXM86161EVSYS# Evaluation System

Evaluates: MAXM86161

MAXM86161EVSYS# EV System Schematic

Other documentation to use this EV System is available at the [MAXM86161EVSYS# EV System Design Resources](#) tab and at the [MAXREFDES100HDK](#) website.

MAXM86161OSBFLEX Schematic

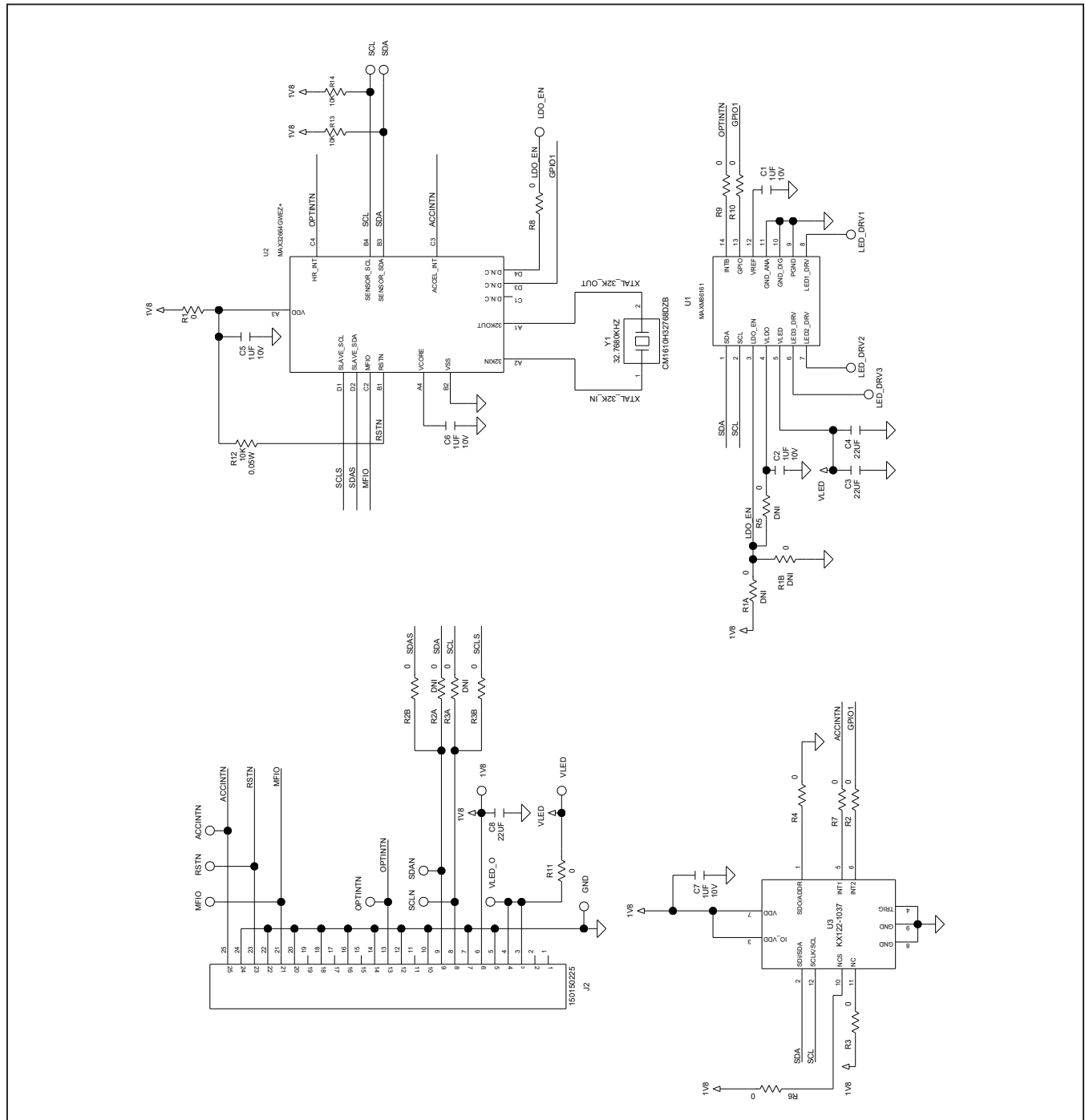

MAXM86161EVSYS# Evaluation System

Evaluates: MAXM86161

MAXM86161EVSYS# EV System Schematic (continued) MAXSensorBLE Schematic (continued)

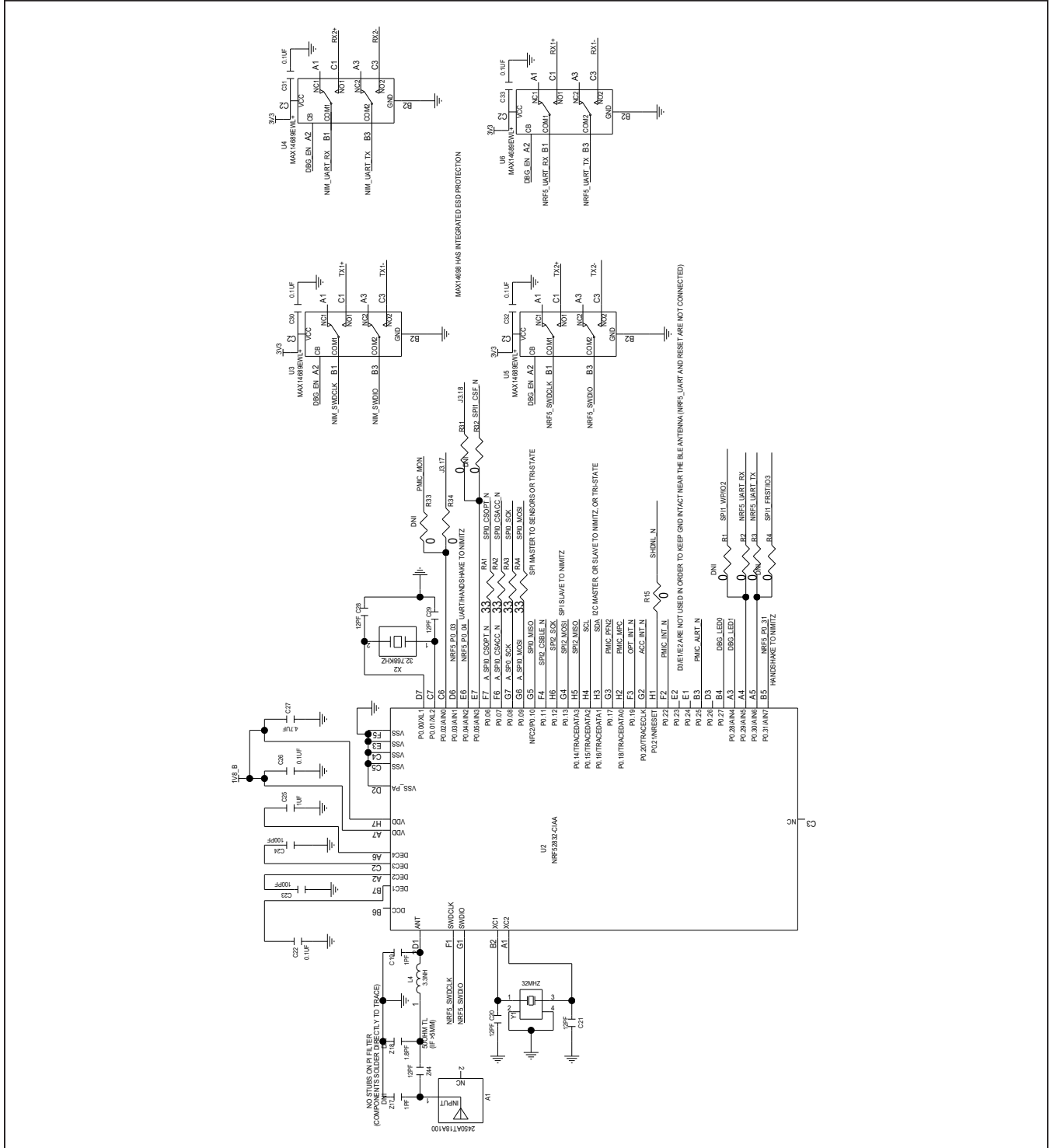

MAXM86161EVSYS# Evaluation System

Evaluates: MAXM86161

MAXM86161EVSYS# EV System PCB Layout

Other documentation to use this EV System is available at the [MAXM86161EVSYS# EV System Design Resources](#) tab and at the [MAXREFDES100HDK](#) website.

MAXM86161OSBFLEX PCB Layout

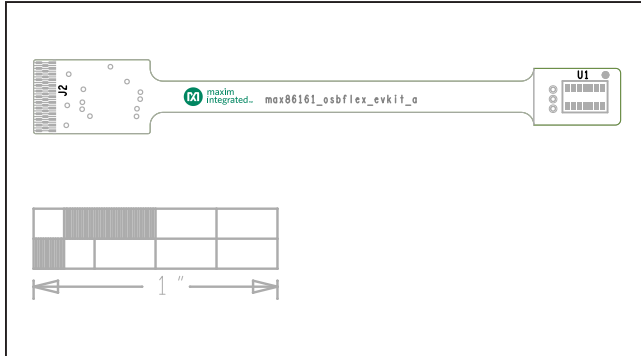

MAXM86161OSBFLEX—Top Silkscreen

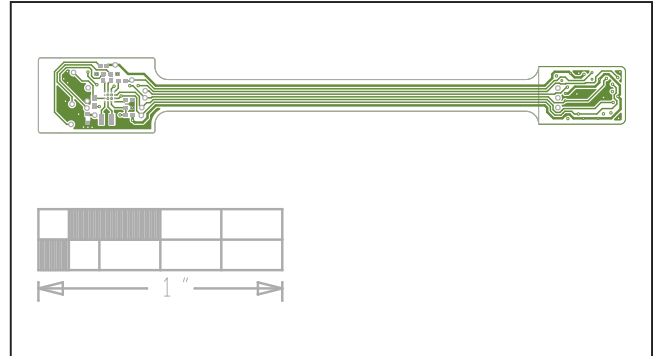

MAXM86161OSBFLEX—Layer 3

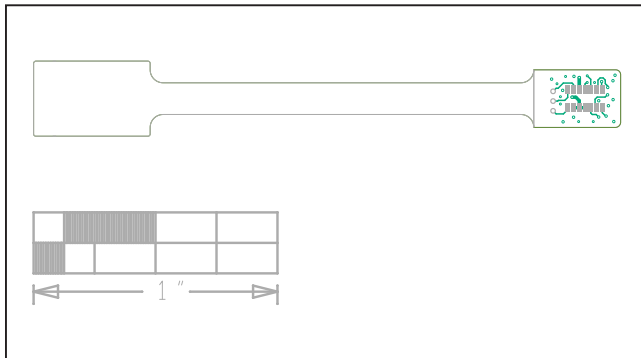

MAXM86161OSBFLEX—Top Layer

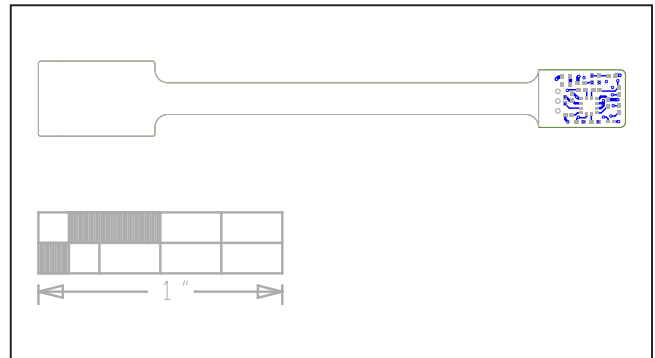

MAXM86161OSBFLEX—Bottom Layer

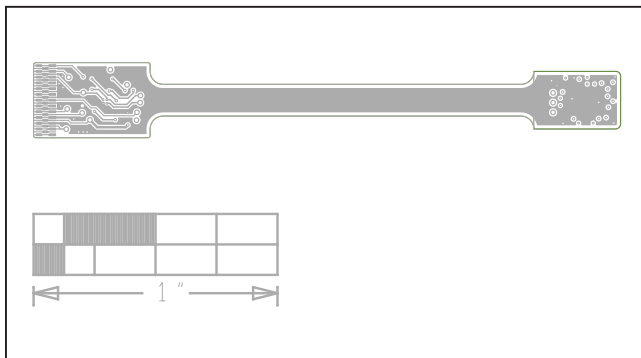

MAXM86161OSBFLEX—Layer 2

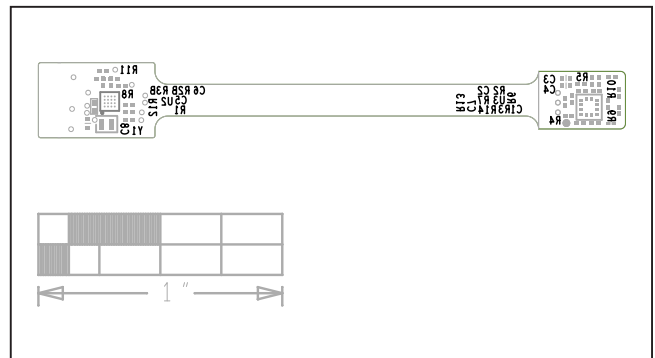

MAXM86161EVSYS# Evaluation System

Evaluates: MAXM86161

MAXM86161EVSYS# EV System PCB Layout (continued)

Other documentation to use this EV System is available at the [MAXM86161EVSYS# EV System Design Resources](#) tab and at the [MAXREFDES100HDK](#) website.

MAXSensorBLE PCB Layout

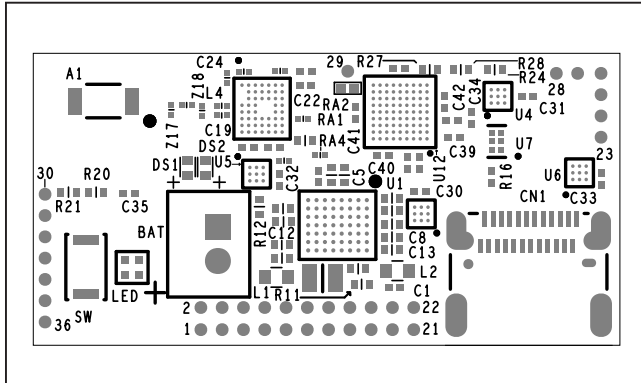

MAXSENSORBLE—Top Silkscreen

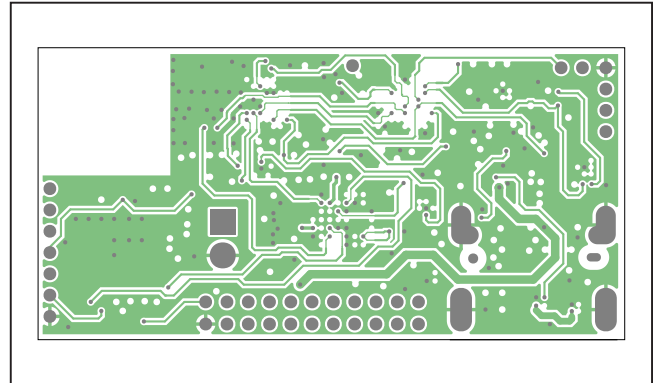

MAXSENSORBLE—Layer 3

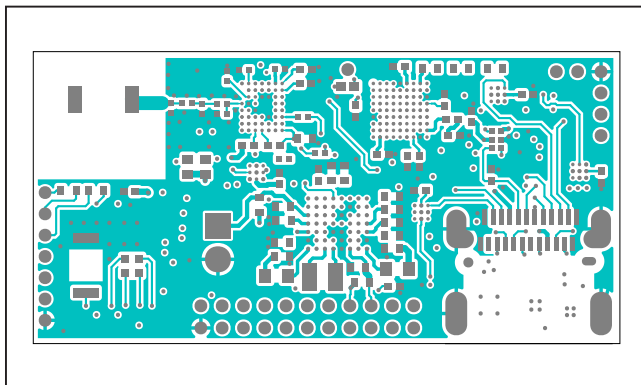

MAXSENSORBLE—Top Layer

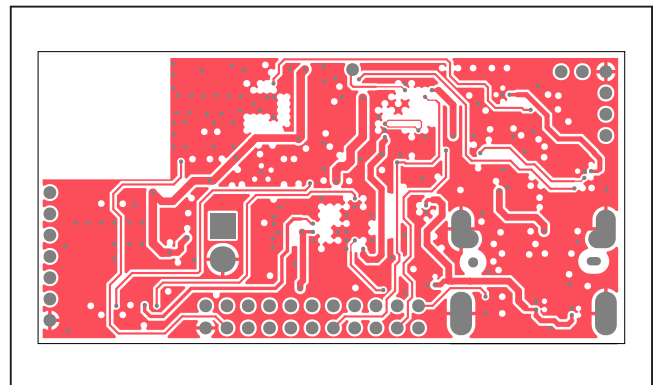

MAXSENSORBLE—Layer 4

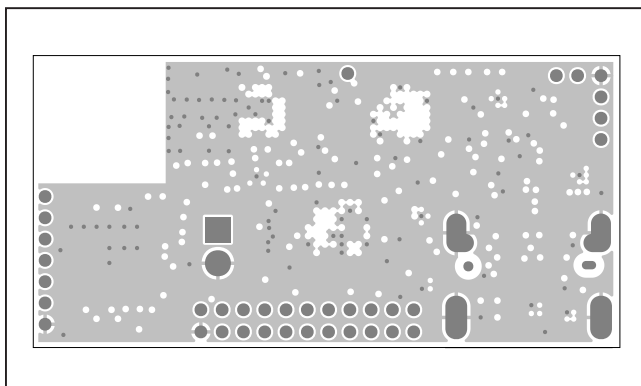

MAXSENSORBLE—Layer 2

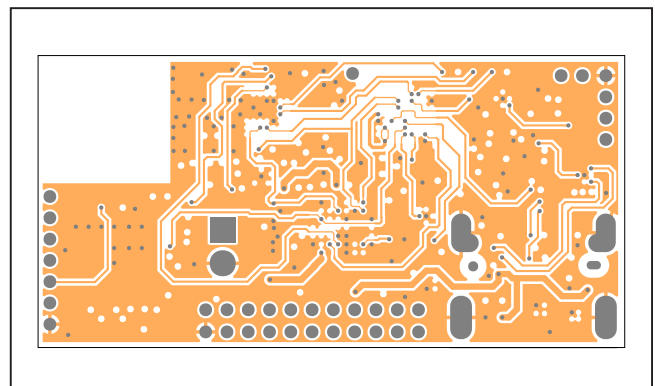

MAXSENSORBLE—Layer 5

MAXM86161EVSYS# Evaluation System

Evaluates: MAXM86161

MAXM86161EVSYS# EV System PCB Layout (continued)

MAXSensorBLE PCB Layout (continued)

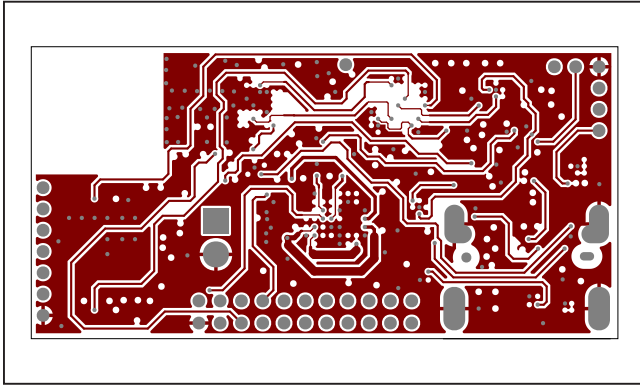

MAXSENSORBLE—Layer 6

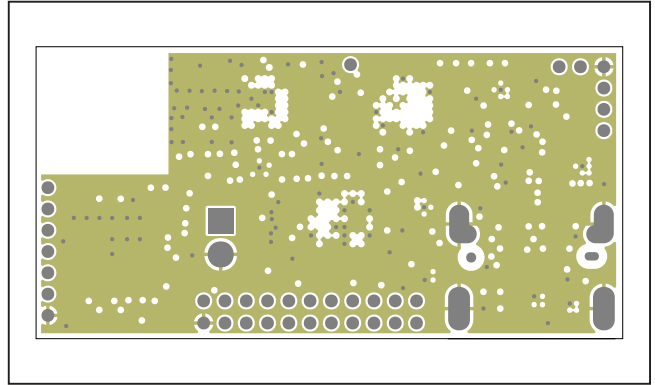

MAXSENSORBLE—Layer 9

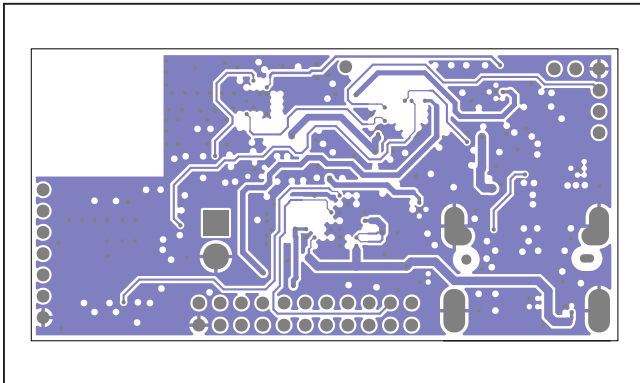

MAXSENSORBLE—Layer 7

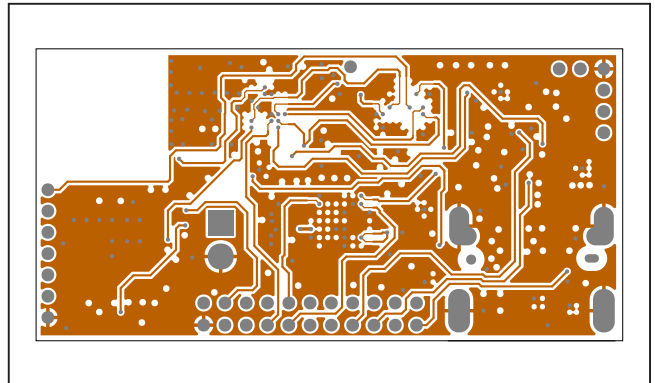

MAXSENSORBLE—Layer 10

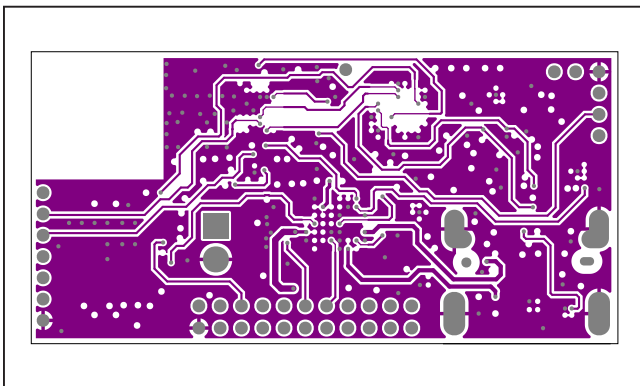

MAXSENSORBLE—Layer 8

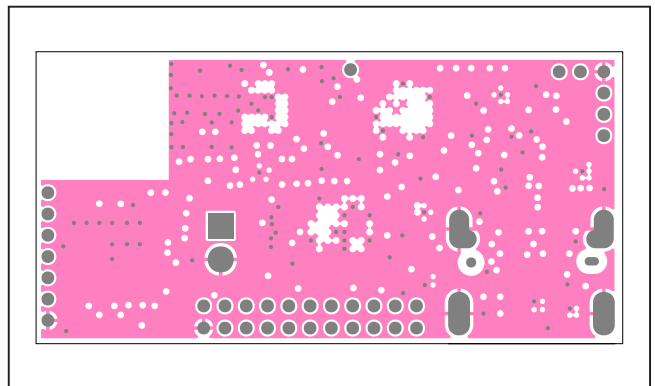

MAXSENSORBLE—Layer 11

MAXM86161EVSYS# Evaluation System

Evaluates: MAXM86161

MAXM86161EVSYS# EV System PCB Layout (continued) MAXSensorBLE PCB Layout (continued)

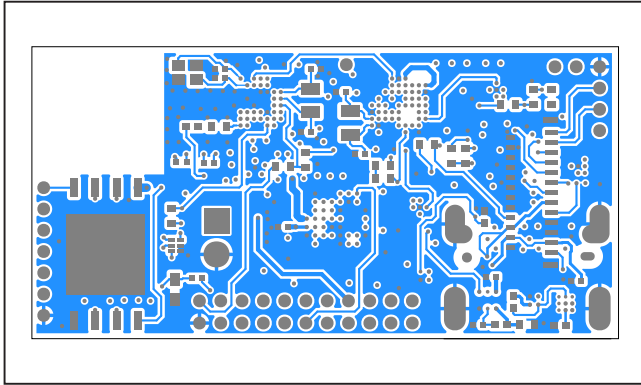

MAXSENSORBLE—Bottom Layer

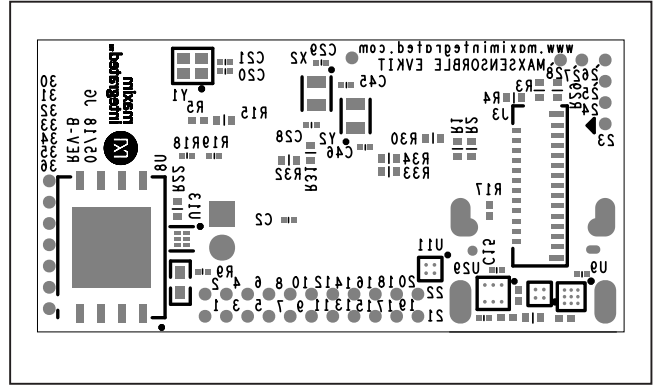

MAXSENSORBLE—Bottom Silkscreen