



TAOGLAS®



Datasheet

Apex Magforce Magnetic Mount 5G/4G Antenna

Part No:
MB.TG30.A.305111

Features:

- High Efficiency and Peak Gain
- Wideband Cellular 5G/4G
- 600-6000MHz Operational
- Straight Fixed Dipole Terminal Antenna
- Strong Magnetic Bond to Metal Surfaces
- 3 Meters TGC-200 Low Loss Coaxial Cable
- SMA(M) Connector
- Cable length and connector customizable
- RoHS and REACH Compliant

1. Introduction	3
2. Specifications	4
3. Antenna Characteristics	6
4. Radiation Patterns	9
5. Mechanical Drawing	20
6. Packaging	21
<hr/>	
Changelog	22

Taoglas makes no warranties based on the accuracy or completeness of the contents of this document and reserves the right to make changes to specifications and product descriptions at any time without notice. Taoglas reserves all rights to this document and the information contained herein. Reproduction, use or disclosure to third parties without express permission is strictly prohibited.



1. Introduction



The Apex Magforce MB.TG30.A.305111 Magnetic Mounted LTE Antenna with cable and connector is primarily designed for use with 5G/4G modules that require highest possible efficiency and peak gain to deliver best in class throughput on all major LTE bands worldwide for terminal applications. The antenna can be easily mounted on any metal plate.

This Magnetic Mount LTE antenna utilizes the highly successful TG.30 antenna as its main element, providing an ultra wide-band response so it can also be used for other cellular and wireless applications such as fallback to 3G, WI-FI, and assisted GPS. With its unique ultra-wideband dipole design, best in industry performance characteristics is provided, with up to 90% efficiency. It is the recommended solution for products that require highest standard network certifications. The radiation patterns are Omni-directional and stable across all bands.

It has a quality robust IP67 housing (connector and magnetic base is IP65) for use with wireless devices. The antenna comes as standard with 3 meters TGC-200 low loss coaxial cable and a SMA male connector. A super magnet in the base provides a strong magnetic bond (max magnetic Pull Force 2.92kgf) to the metal surface it is mounted on.

Cable length and connector type are customizable for a minimum order quantity. For further information please contact your regional Taoglas customer support team.

2. Specifications

LTE Electrical								
Band	Frequency (MHz)	Efficiency (%)	Average Gain (dB)	Peak Gain (dBi)	Impedance	Polarization	Radiation Pattern	Max. input power
5GNR/4G Band71	617-698	19.1	-7.20	-1.92	50 Ω	Linear	Omni	2W
4G/3G Band 12,13,14,17,28,29	698-806	54.6	-2.62	2.54				
4G/3G/NB-IoT/Cat M Band 5,8,18,19,20,26,27	824-960	54.5	-2.64	2.86				
5GNR/4G Band 21,32,74,75,76	1427-1518	48.0	-3.18	3.47				
4G/3G Band 1,2,3,4,9,23,25,35,39,66	1710-2200	50.3	-2.99	2.75				
4G/3G Band 7,30,38,40,41	2300-2690	34.0	-4.69	2.15				
5GNR/4G Band 22,42,48,77,78,79	3300-5000	36.5	-4.38	4.33				
LTE5200/Wi-Fi5800	5150-5925	29.5	-5.30	3.01				

Mechanical	
Casing	ABS
Cable type	TGC-200
Cable Length	3 Meters, Standard
Connector	SMA Male, Standard
Weight	Antenna Main Body:40g Magnetic Mounted Base:370g
Water Proof	IP67 for Antenna Casing, IP65 for Total part
Magnetic Pulling Force	2.92Kgf
Environmental	
Storage Temperature Range	-40°C to 85°C
Operation Temperature Range	-40°C to 85°C
Humidity	Non-condensing 65°C 95% RH

5G/4G Bands			
Band Number	5GNR / FR1 / LTE / LTE-Advanced / WCDMA / HSPA / HSPA+ / TD-SCDMA		
	Uplink	Downlink	Covered
B1	1920 to 1980	2110 to 2170	✓
B2	1850 to 1910	1930 to 1990	✓
B3	1710 to 1785	1805 to 1880	✓
B4	1710 to 1755	2110 to 2155	✓
B5	824 to 849	869 to 894	✓
B7	2500 to 2570	2620 to 2690	✓
B8	880 to 915	925 to 960	✓
B9*	1749.9 to 1784.9	1844.9 to 1879.9	✓
B11	1427.9 to 1447.9	1475.9 to 1495.9	✓
B12	699 to 716	729 to 746	✓
B13	777 to 787	746 to 756	✓
B14	788 to 798	758 to 768	✓
B17	704 to 716	734 to 746	✓
B18	815 to 830	860 to 875	✓
B19	830 to 845	875 to 890	✓
B20	832 to 862	791 to 821	✓
B21	1447.9 to 1462.9	1495.9 to 1510.9	✓
B22*	3410 to 3490	3510 to 3590	*
B23*	2000 to 2020	2180 to 2200	✓
B24	1626.5 to 1660.5	1525 to 1559	✓
B25	1850 to 1915	1930 to 1995	✓
B26	814 to 849	859 to 894	✓
B27*	807 to 824	852 to 869	✓
B28	703 to 748	758 to 803	✓
B29		717 to 728	✓
B30	2305 to 2315	2350 to 2360	✓
B31	452.5 to 457.5	462.5 to 467.5	✓
B32		1452 to 1496	✓
B34		2010 to 2025	✓
B35		1850 to 1910	✓
B36		1930 to 1990	✓
B37		1910 to 1930	✓
B38		2570 to 2620	✓
B39		1880 to 1920	✓
B40		2300 to 2400	✓
B41		2496 to 2690	✓
B42		3400 to 3600	*
B43		3600 to 3800	✓
B45		1447 to 1467	✓
B46		5150 to 5925	✓
B47		5855 to 5925	✓
B48		3550 to 3700	✓
B49		3550 to 3700	✓
B50		1432 to 1517	✓
B51		1427 to 1432	✓
B52		3300 to 3400	*
B53		2483.5 to 2495	✓
B65	1920 to 2010	2110 to 2200	✓
B66	1710 to 1780	2110 to 2200	✓
B68	698 to 728	753 to 783	✓
B69		2570 to 2620	✓
B70	1695 to 1710	1995 to 2020	✓
B71	663 to 698	617 to 652	*
B72	451 to 456	461 to 466	✓
B73	450 to 455	460 to 465	✓
B74	1427 to 1470	1475 to 1518	✓
B75		1432 to 1517	✓
B76		1427 to 1432	✓
B77		3300 to 4200	✓
B78		3300 to 3800	*
B79		4400 to 5000	✓
B85	698 to 716	728 to 746	✓
B87	410 to 415	420 to 425	✓
B88	412 to 417	422 to 427	✓

3. Antenna Characteristics

3.1 Return Loss

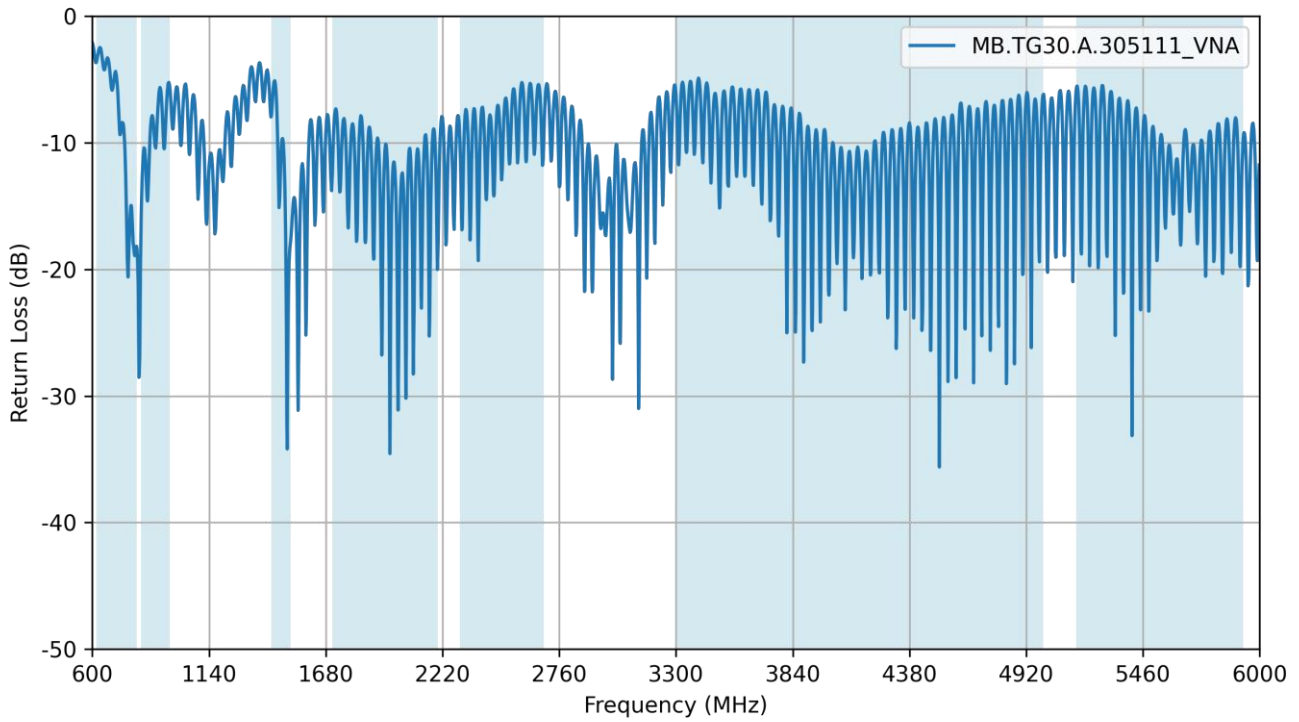

3.2 VSWR

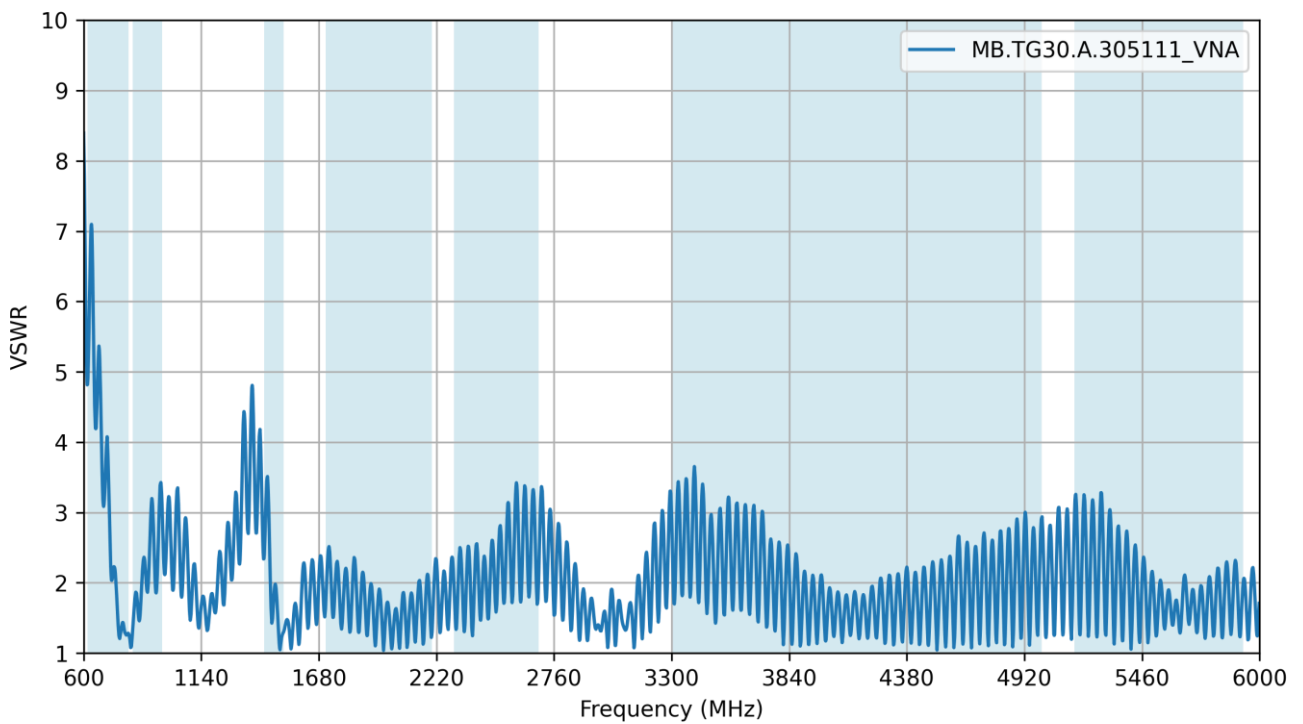

3.3 Efficiency

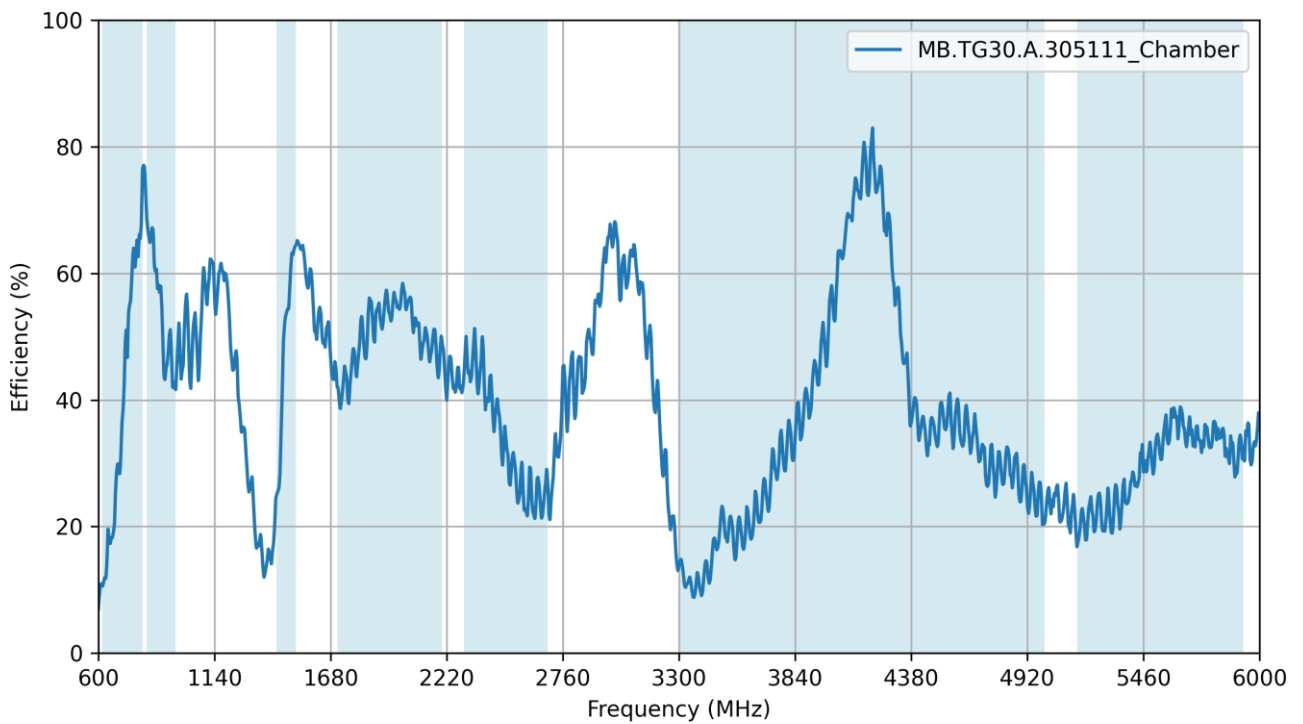

3.4 Average Gain

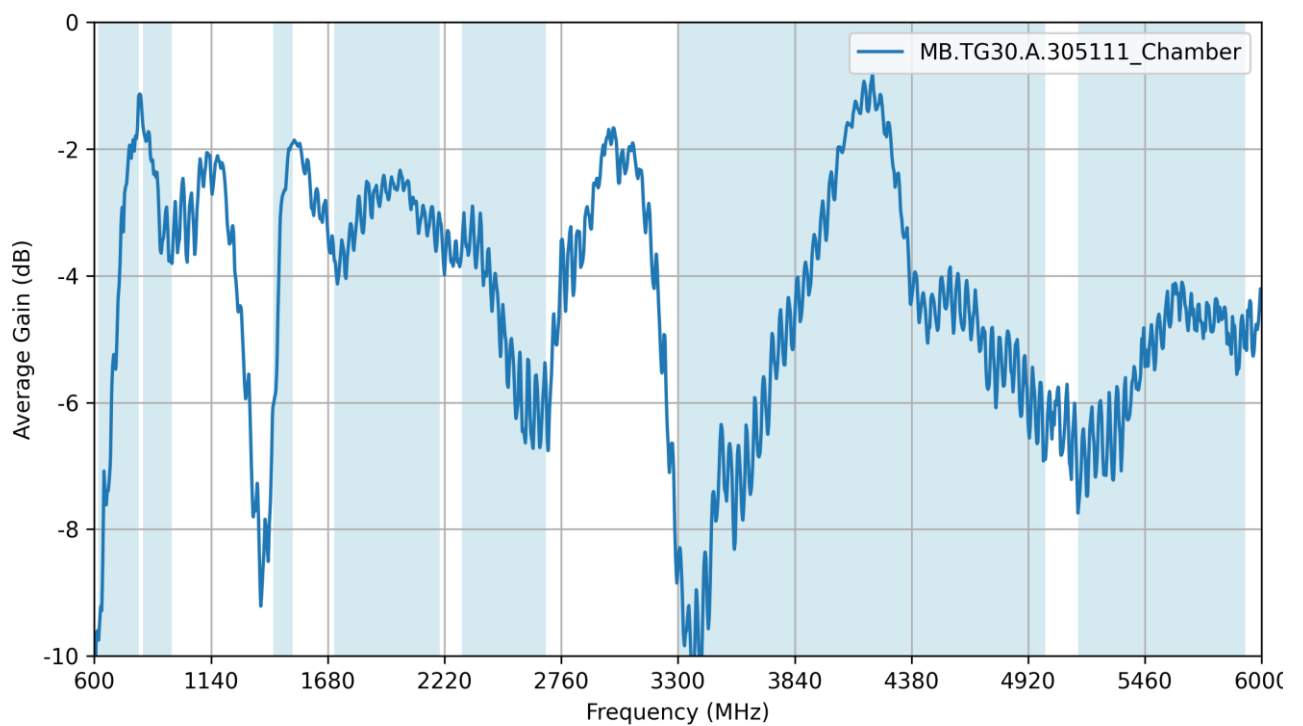

3.5 Peak Gain

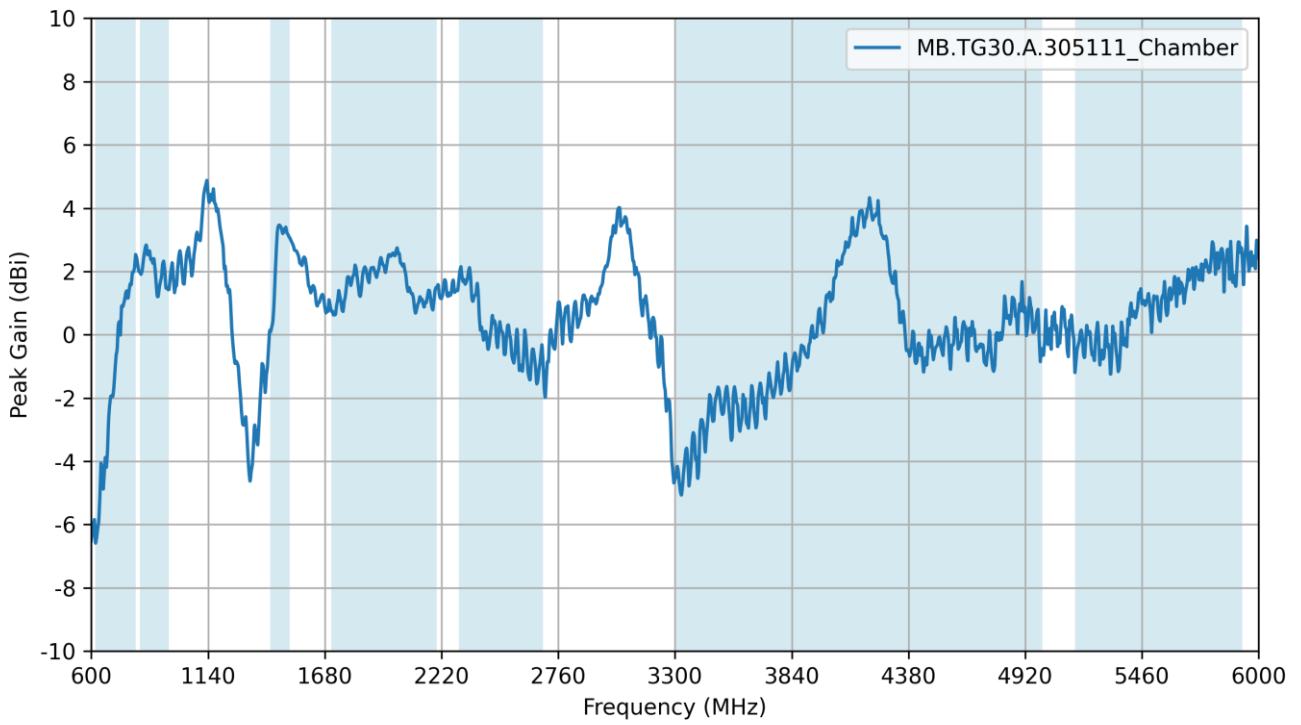

4. Radiation Patterns

4.1 Test Setup – Freespace

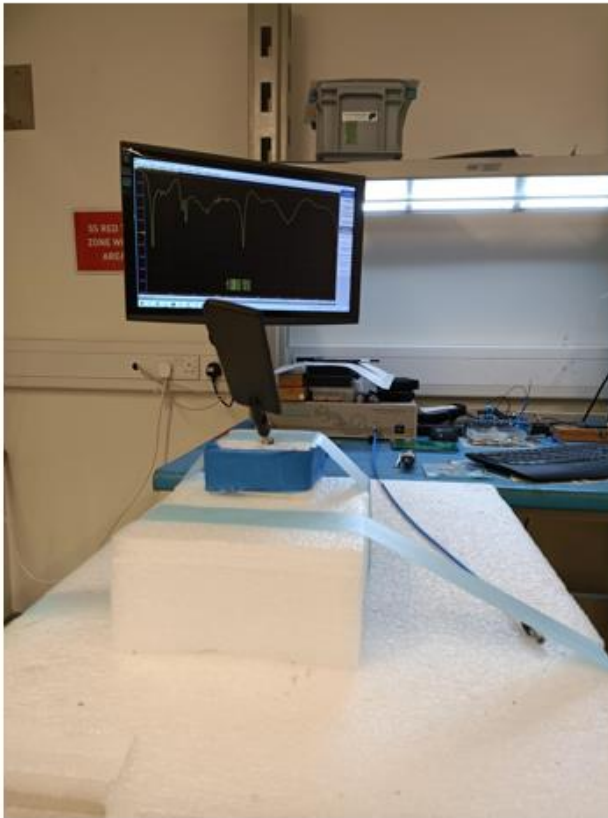

VNA Setup in Freespace

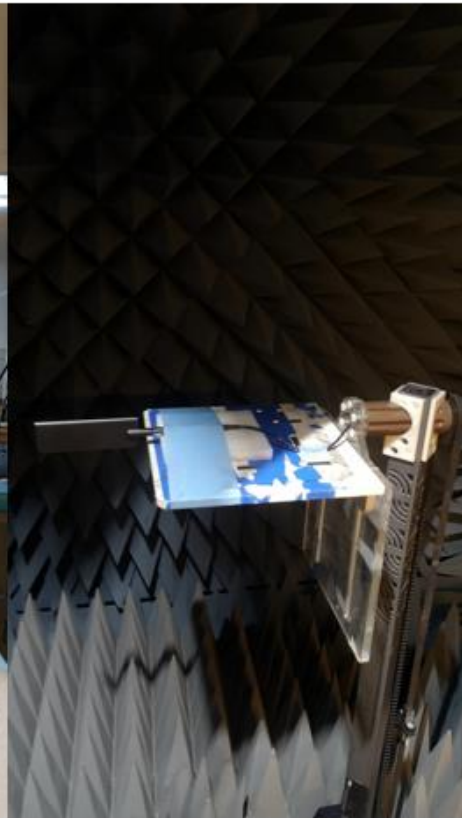

Chamber Setup in Freespace

4.2 Freespace 2D & 3D Radiation Patterns

650MHz

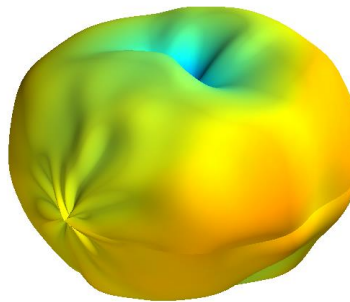
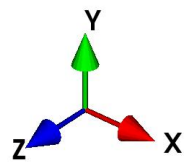

XZ Plane

YZ Plane

XY Plane

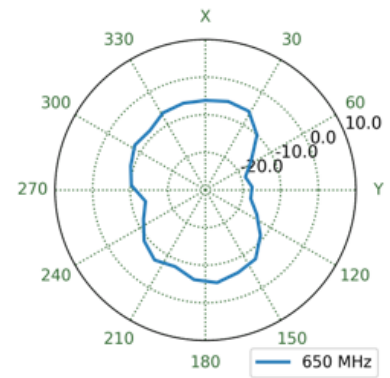
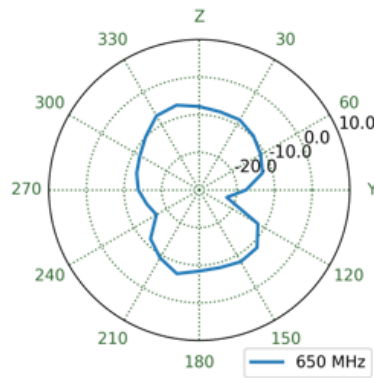
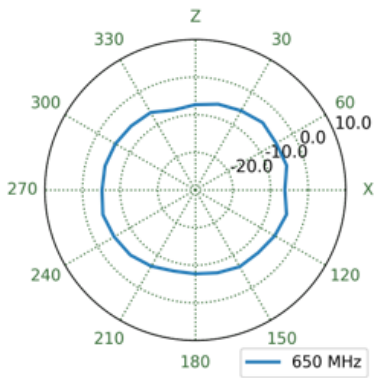

750MHz

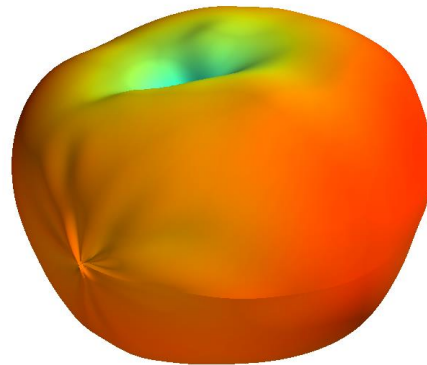
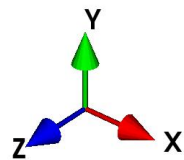

XZ Plane

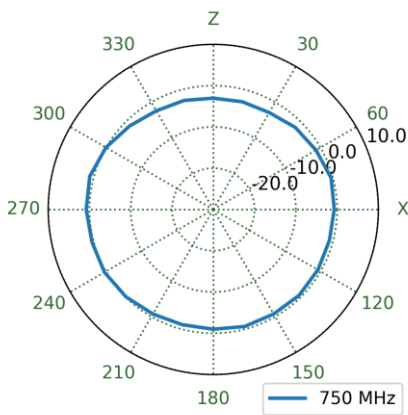

YZ Plane

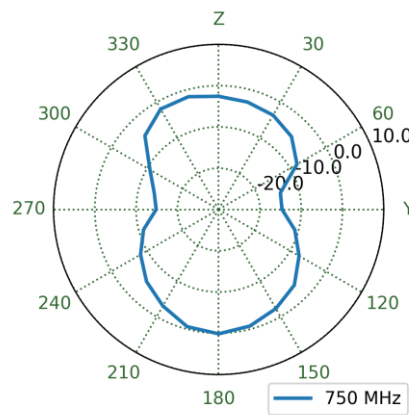

XY Plane

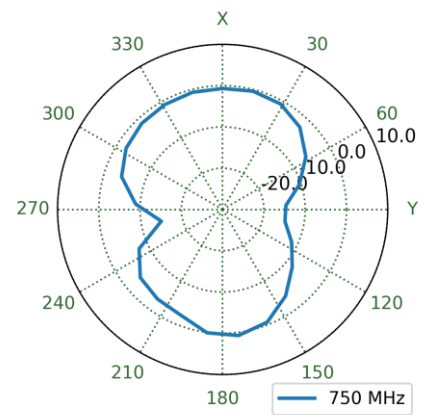

890MHz

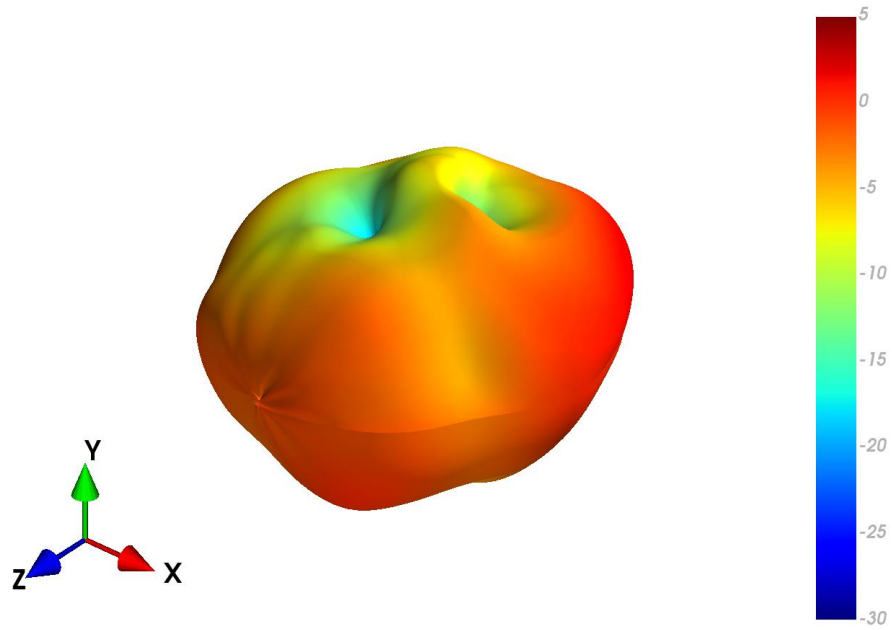

XZ Plane

YZ Plane

XY Plane

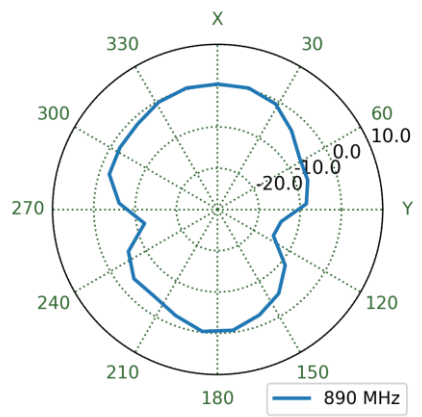
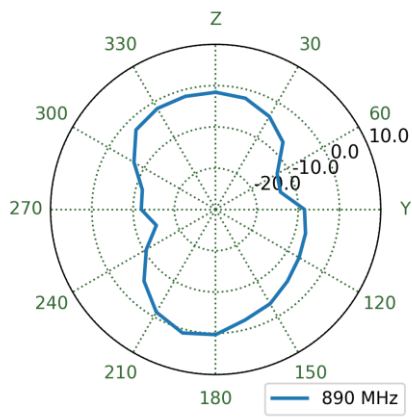
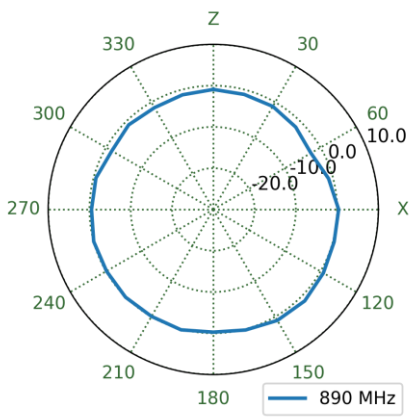

1470MHz

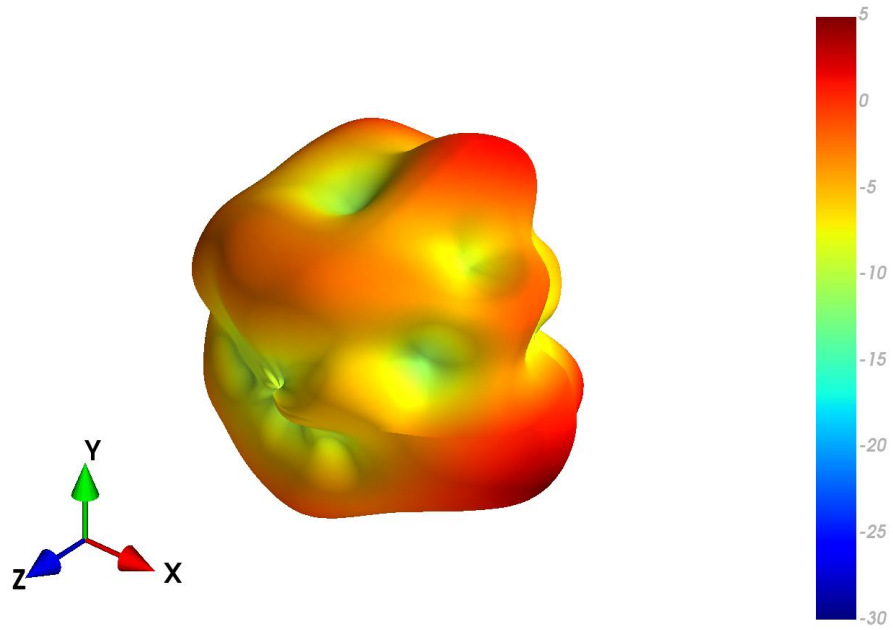

XZ Plane

YZ Plane

XY Plane

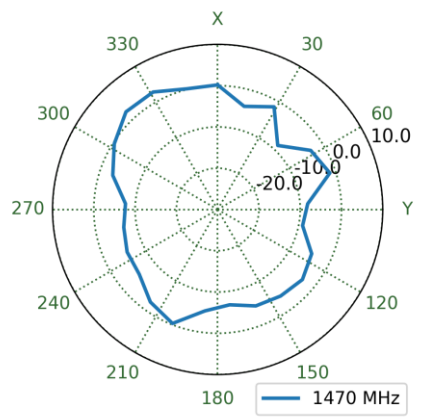
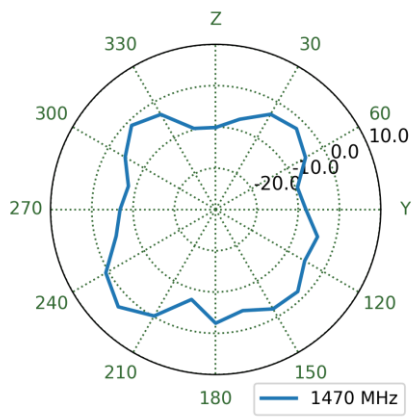
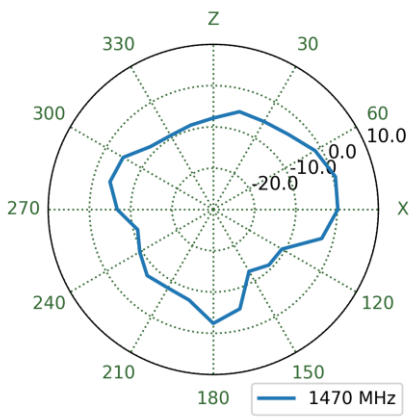

1805MHz

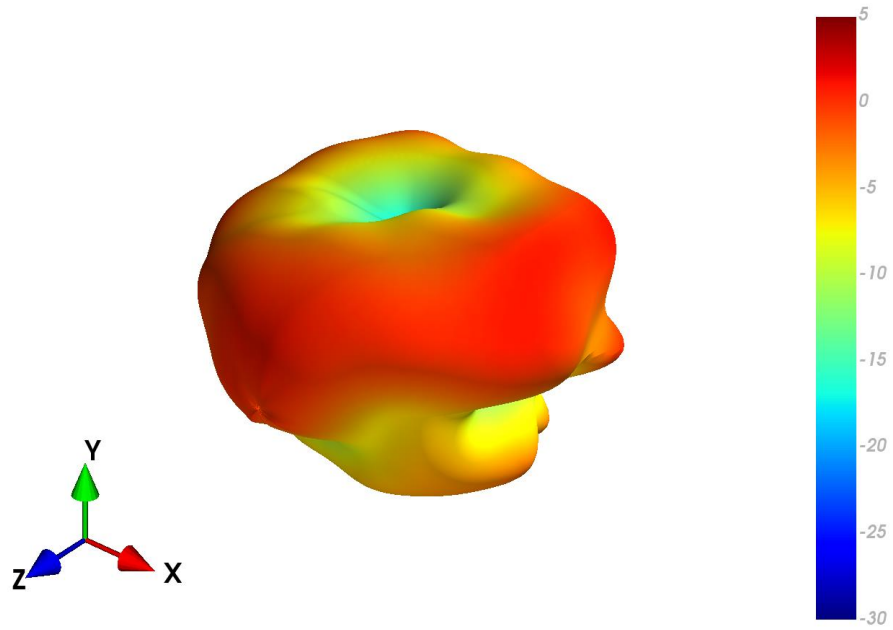

XZ Plane

YZ Plane

XY Plane

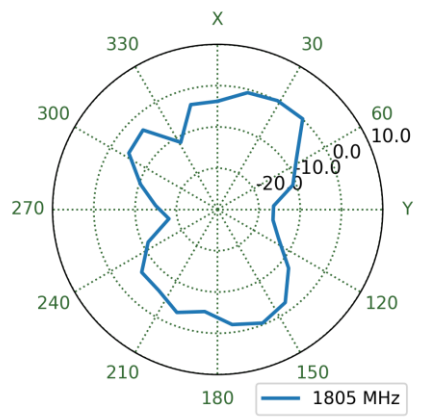
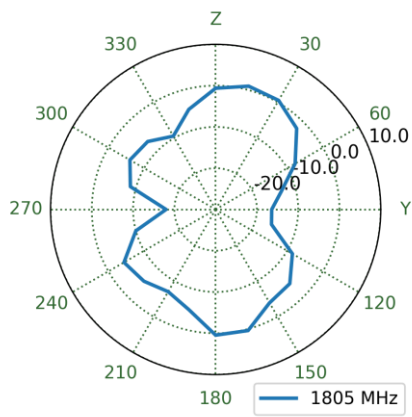
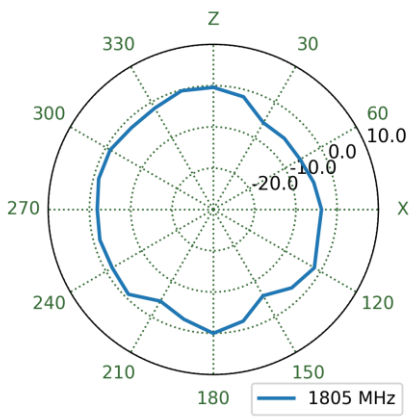

1920MHz

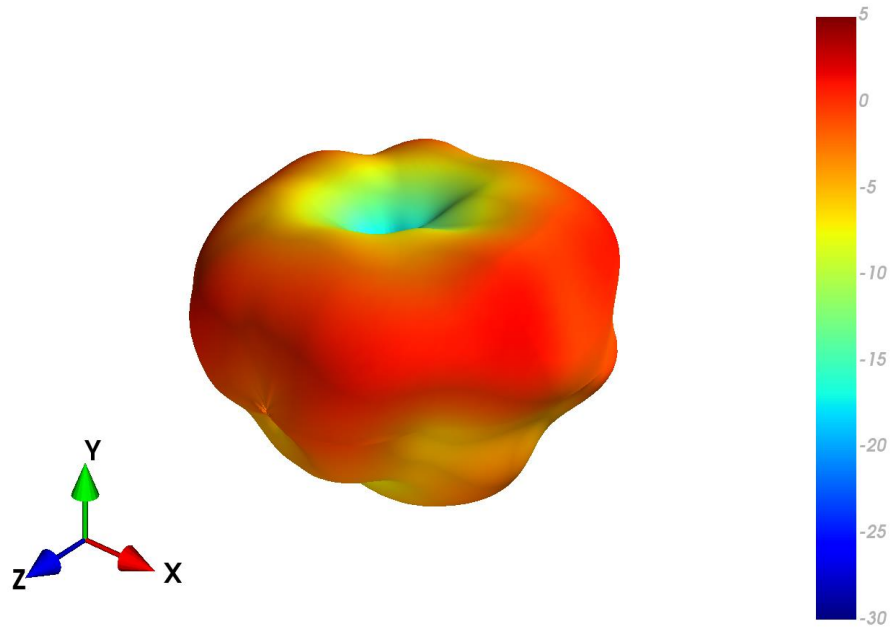

XZ Plane

YZ Plane

XY Plane

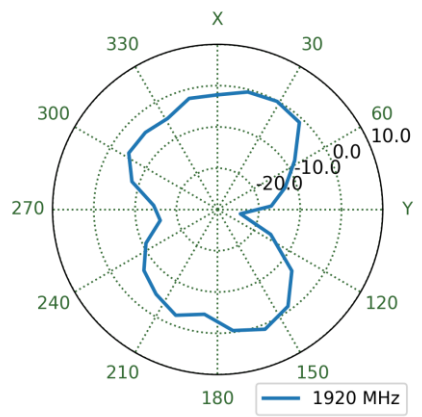
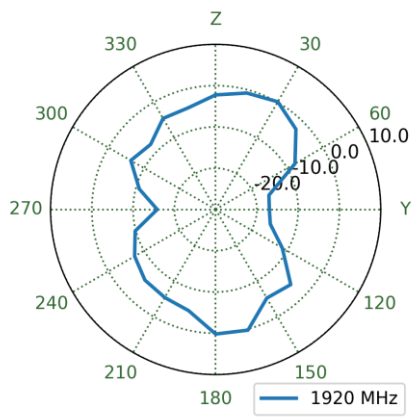
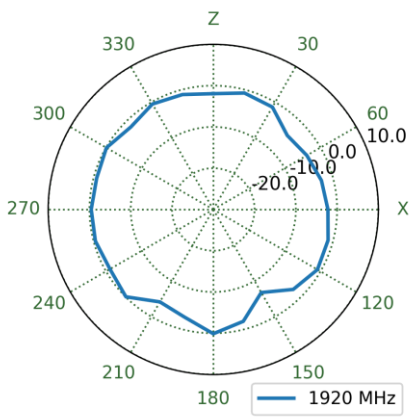

1990MHz

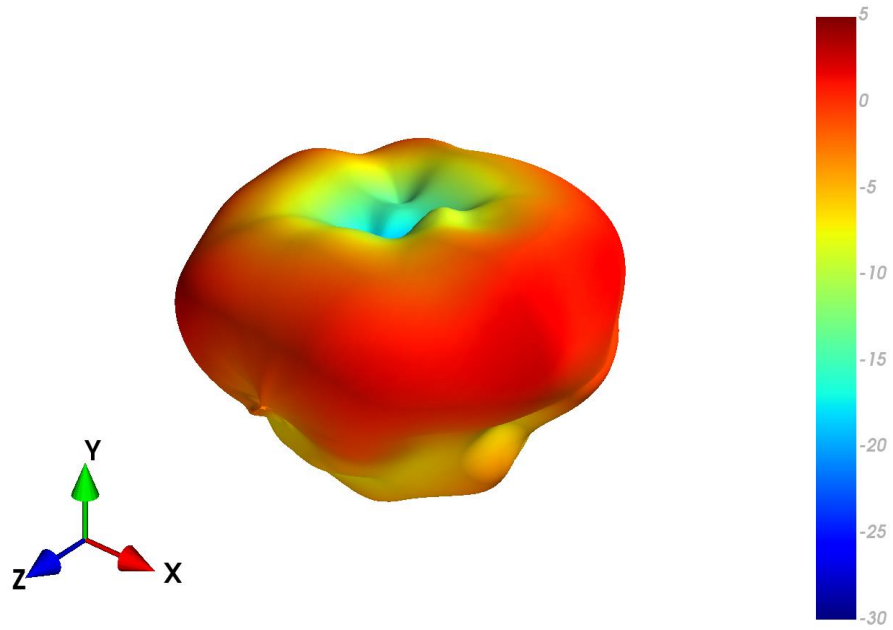

XZ Plane

YZ Plane

XY Plane

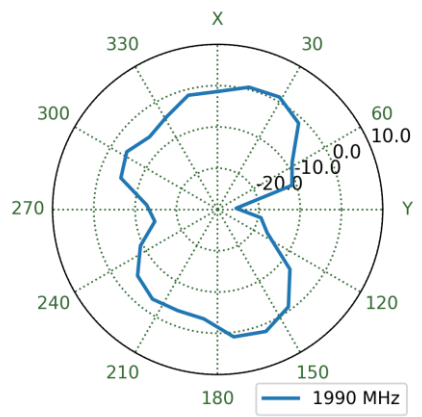
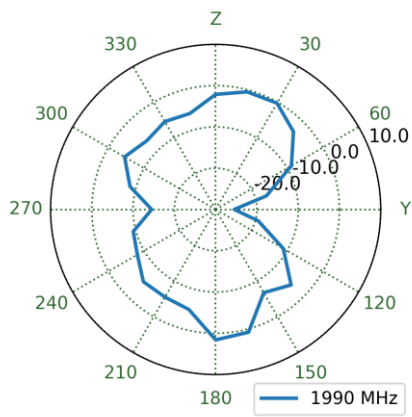
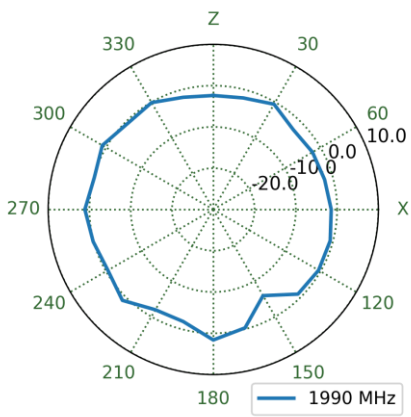

2595MHz

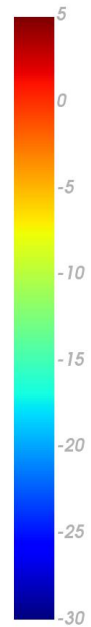
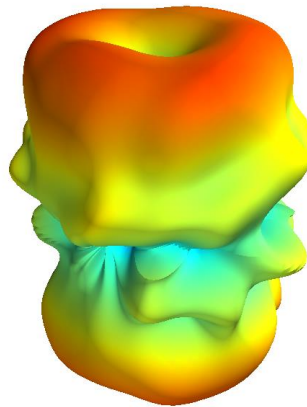
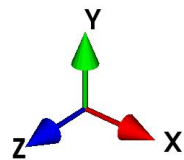

XZ Plane

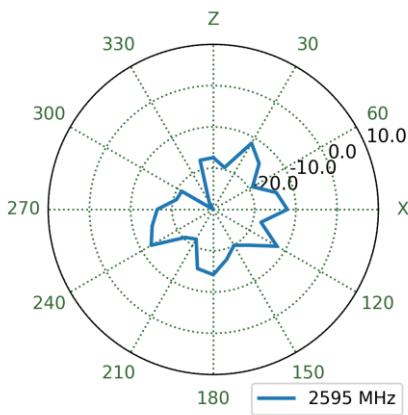

YZ Plane

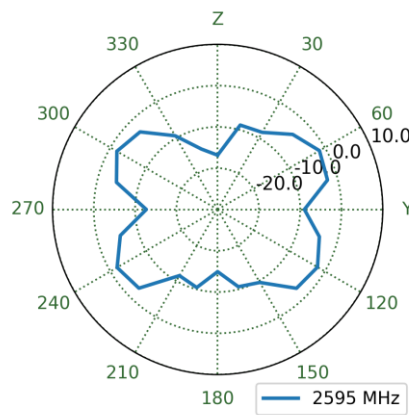

XY Plane

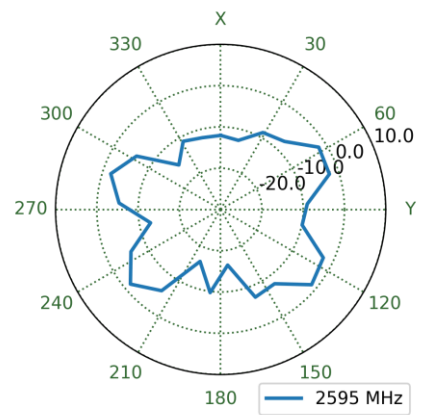

3550MHz

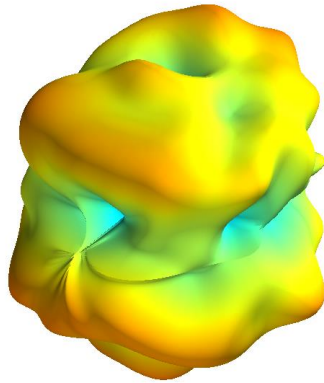
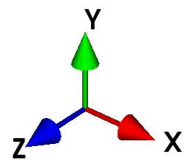

XZ Plane

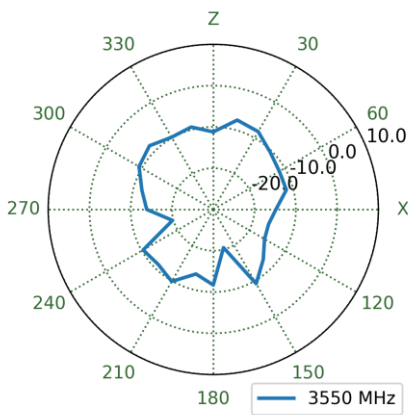

YZ Plane

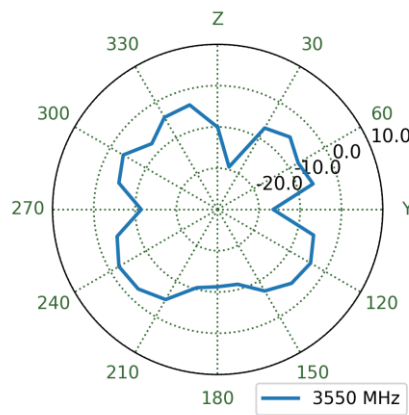

XY Plane

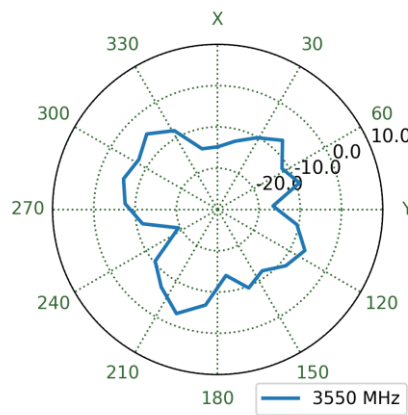

5530MHz

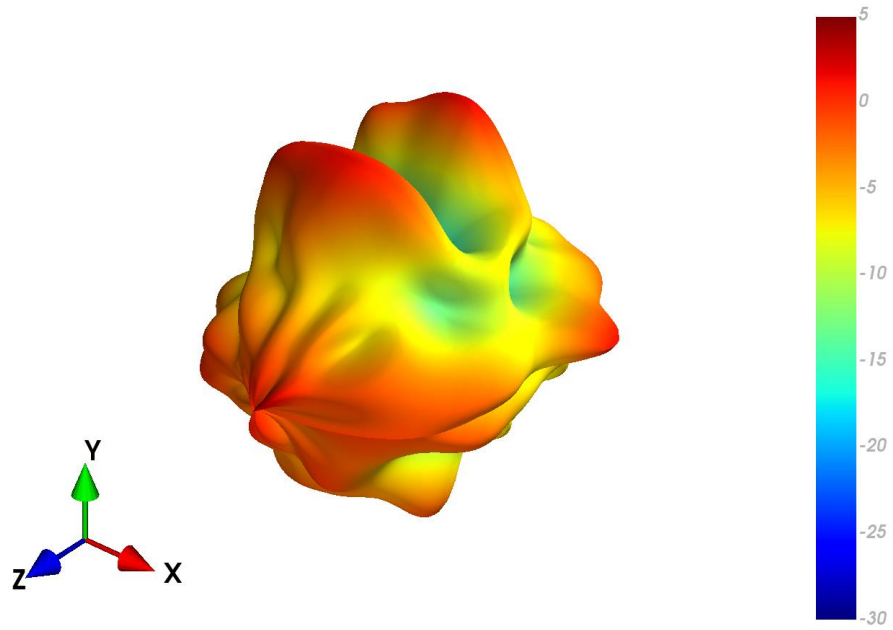

XZ Plane

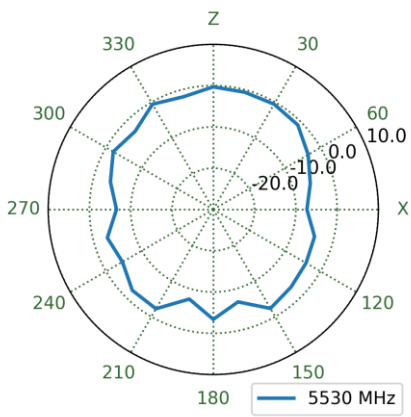

YZ Plane

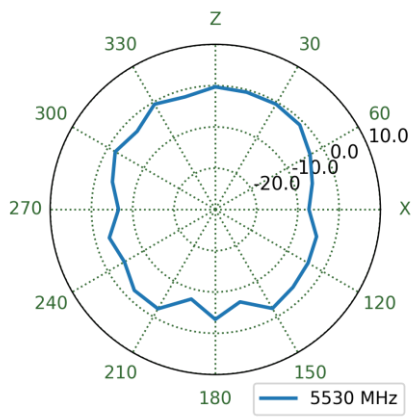

XY Plane

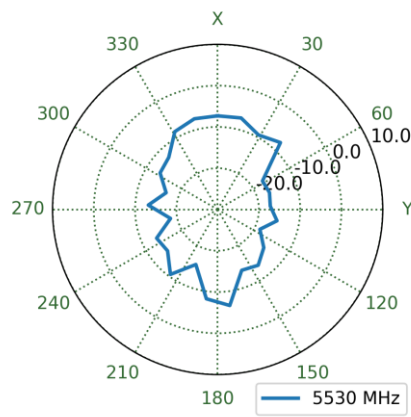

5. Mechanical Drawing (Units: mm)

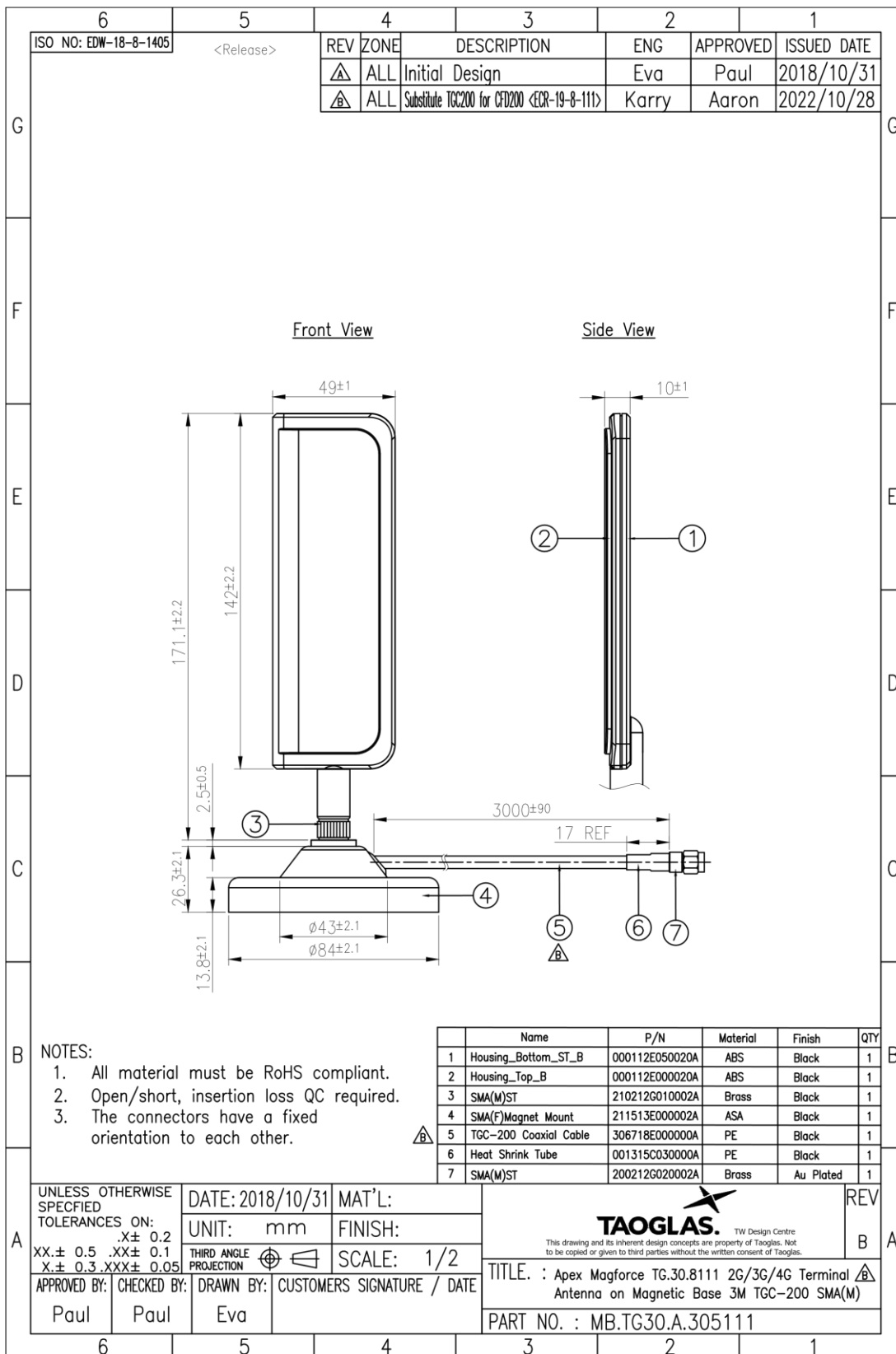

6. Packaging

MB.TG30.A.305111
1 pcs / Small PE Bag



MB.TG30.A.305111 - 18 PCS / Carton
Dimension: 430x380x280mm

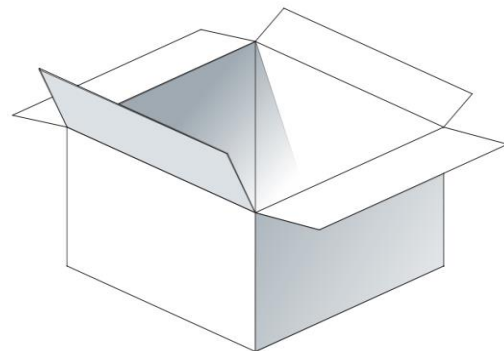

Changelog for the datasheet

SPE-14-8-086 - MB.TG30.A.305111

Revision: C (Current Version)	
Date:	2022-12-19
Changes:	Updated specifications
Changes Made by:	Cesar Sousa

Previous Revisions

Revision: B	
Date:	2017-04-04
Changes:	
Changes Made by:	Technical Writer

Revision: A (Original First Release)	
Date:	2014-08-14
Notes:	
Author:	Technical Writer

--	--

--	--

--	--

--

--

--

--

--