



# Acoustic Interface Design Guide

MEMS MICROPHONES 

ECMs 

SPECIALTY MICROPHONES 

SPECIALTY SPEAKERS 

CUSTOM ASSEMBLIES 

ACOUSTIC SOFTWARE 

MICROPHONE AND SPEAKER BASICS 

# Discover your next acoustic interface solution.



Knowles Acoustics offers you a full spectrum of MEMS microphones, electret condenser microphones, specialty microphones, balanced armature speakers, custom assemblies, and sound conditioning software. This application guide will help you select the right acoustic interface solution.

OVER **60** YEARS  
acoustic innovation

*Knowles reserves the right to change designs and specifications without prior notice. Should a safety concern arise regarding this product, please contact us immediately for technical consultation. Knowles cannot assume responsibility for any problems arising out of the use of this product. This information does not convey any license by any implication under any patents or other right.*

# We can help you every step of the way.

It all starts with your application. Or it starts with an idea you may have. For support from concept to design to sub-assembly, or any step along the way, just call us. Or visit us at [www.knowles.com](http://www.knowles.com)

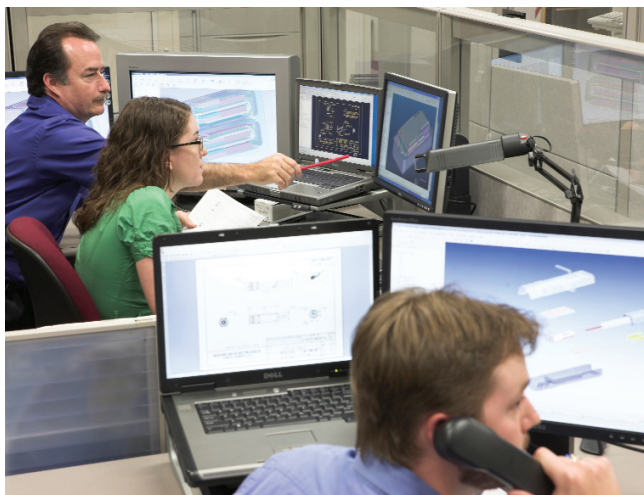

## Table of Contents

- ◎ MICROPHONES - MEMS ..... 4-5
- ◎ MICROPHONES - ECMs ..... 6-8
- ◎ SPECIALTY TRANSDUCERS - MICROPHONES ..... 9-14
- ◎ ACCELEROMETERS & DAMPERS ..... 14
- ◎ SPECIALTY TRANSDUCERS - SPEAKERS ..... 15-23
- ◎ CUSTOM ASSEMBLIES ..... 24
- ◎ ACOUSTIC SOFTWARE ..... 25
- ◀ MICROPHONE AND SPEAKER BASICS ..... 26-27

# MICROPHONES — MEMS

## SiSonic™ MEMS Microphones

The SiSonic™ MEMS microphone series is entering its fourth generation of development, with product shipments exceeding 400 million units to date. The proven and evolving design series continues to support high-performance, high-density innovation in such applications as cell phones, digital still cameras, portable music players, premium earbuds and other portable electronic devices.

Design variables include ever-smaller sizes, lower profiles and mounting options, increased output capacities, and new digital audio options that eliminate analog noise. For manufacturers, surface mount designs eliminate off-line subassembly production costs. Customized designs are supplied on tape-and-reel and can be run through standard automatic pick-n-place equipment during in-line surface mount manufacturing.

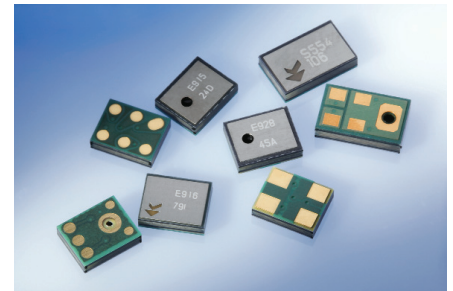

The microphones can also be integrated with our patented IntelliSonic™ software and special porting designs to provide a precisely customized sound.

- New digital mics eliminate analog noise
- New integrated designs with differential or switchable gain
- Zero Height Mic™ for thinnest ever designs
- Original "mini" with footprint less than 18mm<sup>2</sup>
- RF Hardened products eliminate GSM/TDMA burst noise in handset designs

## Part Numbering

### SPM0204HE3-PB-6



1	2	3	4	5	6	7
Product Description	Series	Port Hole Type	RF Filter	Supply Voltage	Version	Packaging QTY
SPU: Ultra (3.76x2.95) SPM: Mini (4.72x3.76)	0204: Standard 0205: Digital 0206: Differential 0207: Switchable 0208: Amplified 0408: Amplified 0409: Standard	H: Standard L:ZHS	D: Standard E: Enhanced	3: 1.5-5.5V 5: 1.5-3.6V	Knowles Internal Reference Only	(7" or 13" Reel) 2: 1200 3: 4500 6: 4800 T: 300 (7" Only)

## Ultrasonic Acoustic Sensor

Derived from our industry-leading MEMS silicon surface mount microphone technology, our new ultrasonic sensor designs function on a high frequency band. Sensor designs are possible across a wide spectrum of applications requiring highly miniaturized solutions for sensing and actuation/signaling.

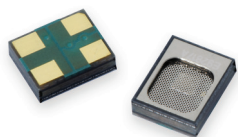

- High frequency functionality
- Wide range of applications
- Micro-sized sensing and actuation

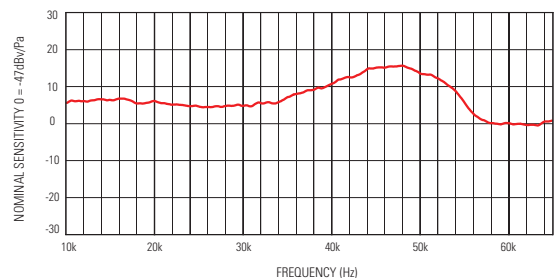

Model	Description	Directivity	Supply Voltage (min-max)	Frequency Range	Sensitivity @1kHz (dB re1V/1Pa)	Output Impedance (Ohms)	Maximum Current Drain (mA)
SPM0204UD5	UAS	Omni	1.5 to 3.6v	10k-65k Hz	-47.0	< 300	< 0.25

## Ultra Mini Package - 3.76 x 2.95 x 1.10 (mm)

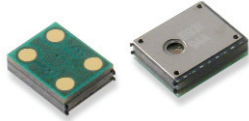

- New Ultra Mini with footprint of 11mm<sup>2</sup>
- Flexible designs available with/without RF filtering and built in amplifier
- Ideal for miniature consumer electronics

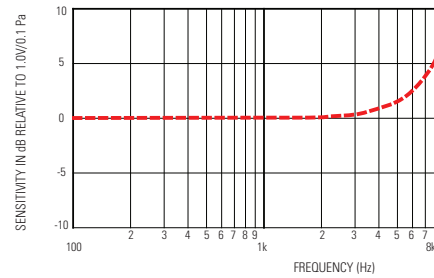

Model	Description	Directivity	Supply Voltage (min-max)	RF Filtering	Sensitivity @1kHz (dB re1V/1Pa)	Output Impedance (Ohms)	Maximum Current Drain (mA)
SPU0409HE5	Standard	Omni	1.5 to 3.6v	Enhanced	-42.0	< 300	< 0.25
SPU0409HD5	Standard	Omni	1.5 to 3.6v	Standard	-42.0	< 300	< 0.25
SPU0409HE5	Amplified	Omni	1.5 to 3.6v	Enhanced	-22.0	< 300	< 0.35
SPU0409HD5	Amplified	Omni	1.5 to 3.6v	Standard	-22.0	< 300	< 0.35

## Thin Mini Package - 4.72 x 3.76 x 1.25 (mm)

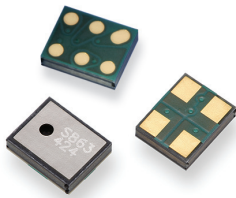

- Thin Mini SiSonic with a footprint less than 18mm<sup>2</sup> reduces manufacturing costs and brings greater design flexibility
- Rugged, solid-state design process for stable acoustic performance under extreme conditions such as temperature, shock and vibration
- Digital - Pulse Density Modulation (PDM) device available, which has an integrated sleep mode and is compatible with stereo input applications

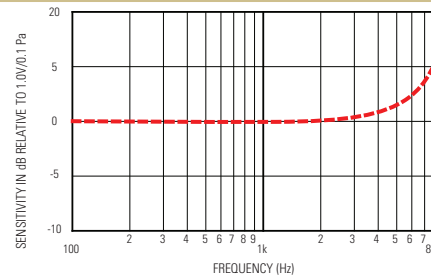

Model	Description	Directivity	Supply Voltage (min-max)	RF Filtering	Sensitivity @1kHz (dB re1V/1Pa)	Output Impedance (Ohms)	Maximum Current Drain (mA)
SPM0204HE5	Standard	Omni	1.5 to 3.6v	Enhanced	-42.0	< 300	< 0.25
SPM0204HD5	Standard	Omni	1.5 to 3.6v	Standard	-42.0	< 300	< 0.25
SPM0208HE5	Amplified	Omni	1.5 to 3.6v	Enhanced	-22.0	< 300	< 0.35
SPM0208HD5	Amplified	Omni	1.5 to 3.6v	Standard	-22.0	< 300	< 0.35
SPM0205HD4	Digital	Omni	1.6 to 3.6v	Standard	-26.0 (1 Pa ref Full Scale)	< 300	< 0.50

## Zero Height Mic™ Thin Mini Package - 4.72 x 3.76 x 1.25 (mm)

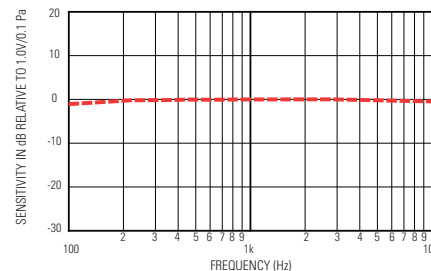
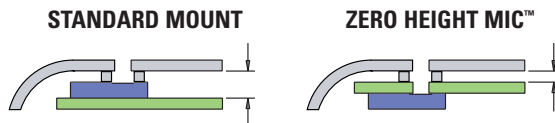
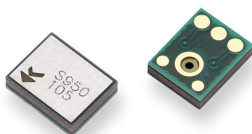

- SiSonic Zero Height Mic™ shrinks product thickness by up to 30%
- Minimizes distance between PCB and mobile device housing
- Ideal for microphone placement on reverse side of PCB, while maintaining acoustic port on top side of mobile device, for clamshell phone designs
- Enables the thinnest, highest density product designs

Model	Description	Directivity	Supply Voltage (min-max)	RF Filtering	Sensitivity @1kHz (dB re1V/1Pa)	Output Impedance (Ohms)	Maximum Current Drain (mA)
SPM0204LE5	Standard	Omni	1.5 to 3.6v	Enhanced	-38.0	< 300	< 0.25
SPM0208LE5	Amplified	Omni	1.5 to 3.6v	Enhanced	-18.0	< 300	< 0.35



# MICROPHONES — ECMs

## Electret Condenser Microphones

Electret Condenser Microphones (ECM) are for general use in all electronic products requiring a microphone. ECMs provide good acoustic performance and reliability under non-severe environmental conditions.

- Highly efficient electrical specifications
- Industry standard sizes
- Omni, Uni, and Noise Canceling Directivities
- Integrated capacitors for RF filtering
- Multiple terminations - Solderless, Pin Type, and Solder Pad
- Used in a wide variety of applications, including wired and wireless headsets, corded and cordless phones, PDAs, notebooks, and mobile phones



## Part Number System and Ordering Information

### MB3015ASC-1

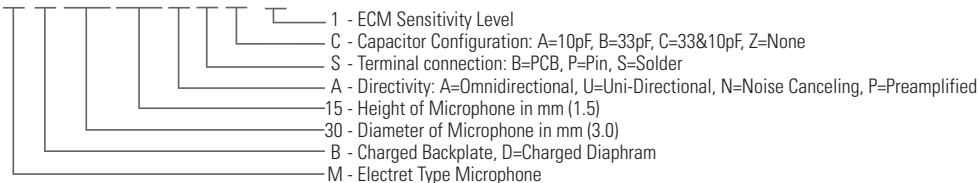

## Omni-Directional – 3 mm



Size (mm)	Part Number	Sensitivity (db)	Filter	Termination
3x1.5	MB3015ASC-1	-42.0±3	10pF & 33pF	Solder Type
	MB3015ASC-2	-44.0±3	10pF & 33pF	Solder Type

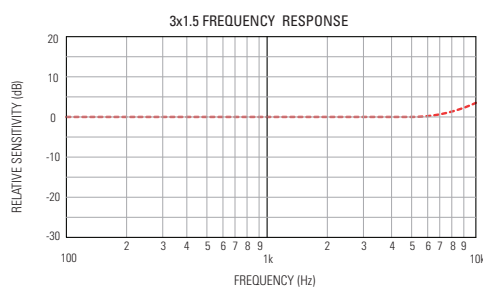

## Omni-Directional – 4 mm

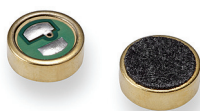

Size (mm)	Part Number	Sensitivity (db)	Filter	Termination
4x1.5	MB4015ASC-1L	-42.0±3	10pF & 33pF	Solder Type

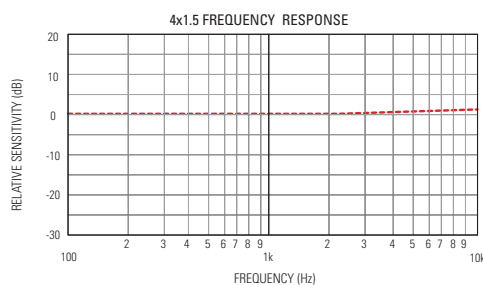

Notes:

1. All sensitivities are referenced at 1 kHz (1V/Pa)
2. Frequency graphs are typical. Contact manufacturer for more detailed information.

# MICROPHONES — ECMs

## Omni-Directional – 6 mm

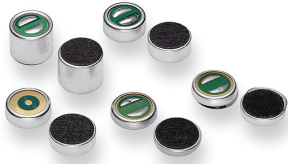

Size (mm)	Part Number	Sensitivity (db)	Filter	Termination
6X1.3	MB6013ASC-1	-42.0±3	10pF & 33pF	Solder Type
6x1.5	MB6015ASC-1	-42.0±3	10pF & 33pF	Solder Type
6x2.2	MB6022ASC-1L	-40.0±3	10pF & 33pF	Solder Type
	MB6022APC-0	-40.0±3	10pF & 33pF	Pin Type
	MB6022ABC-3	-45.0±2	10pF & 33pF	PCB, Bullseye
6x2.7	MB6027ASC-1L	-42.0±3	10pF & 33pF	Solder Type
6X5.2	MB6052ASC-1	-42.0±3	10pF & 33pF	Solder Type

6x1.3 FREQUENCY RESPONSE

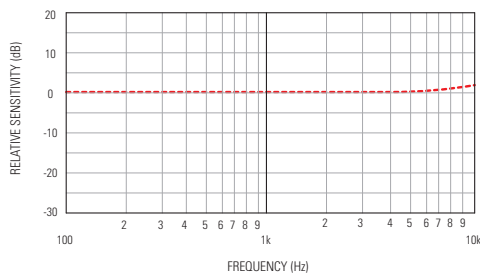

6x1.5 FREQUENCY RESPONSE

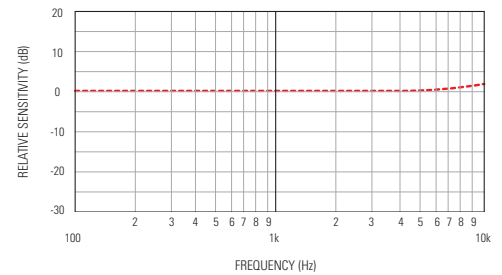

6x2.2 FREQUENCY RESPONSE

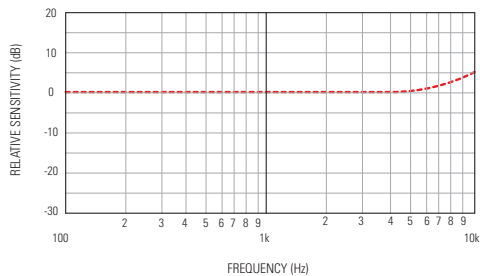

6x2.7 FREQUENCY RESPONSE

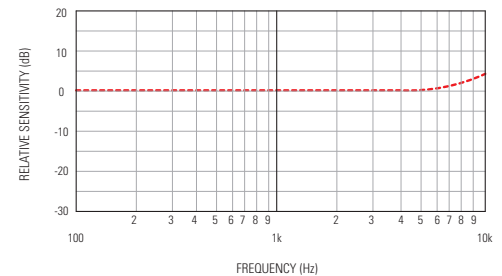

## Omni-Directional – 9.7 mm



Size (mm)	Part Number	Sensitivity (db)	Filter	Termination
9.7x4.5	MD9745APA-1	-41.0±3	10pF	Pin Type
	MD9745APZ-F	-42.0±2	None	Pin Type

9.7x4.5 FREQUENCY RESPONSE

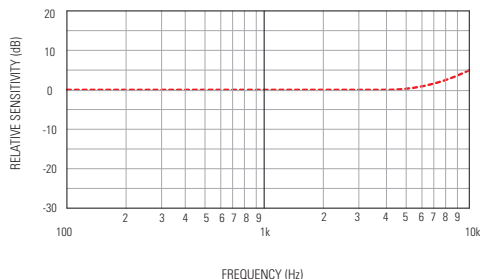

**Notes:**

1. All sensitivities are referenced at 1 kHz (1V/Pa)
2. Frequency graphs are typical. Contact manufacturer for more detailed information.

# MICROPHONES — ECMs

## Uni-Directional – 3 mm, 6 mm, 9.7 mm



Size (mm)	Part Number	Sensitivity (db)	Filter	Termination
3x1.5	MB3015USB-3	-47.0±3	33pF	Solder Type
	MB3015USB-4	-49.0±3	33pF	Solder Type
6x2.2	MB6022USC-3	-47.0±3	10pF & 33pF	Solder Type
	MB6022USC-3P	-47.0±3	10pF & 33pF	Solder Type
6x2.7	MB6027USC-3	-47.0±3	10pF & 33pF	Solder Type
6x5.2	MB6052USZ-2	-44.0±3	None	Solder Type
9.7x5	MB9750USB-4	-47.0±4	33pF	Solder Type

3x1.5 FREQUENCY RESPONSE

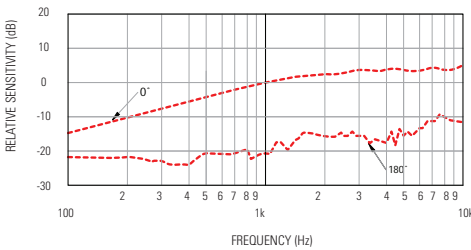

6x2.2, 6x2.7, 6x5.2 FREQUENCY RESPONSE

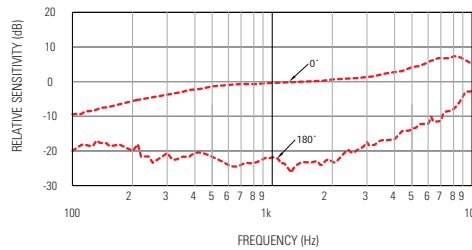

9.7x5.0 FREQUENCY RESPONSE

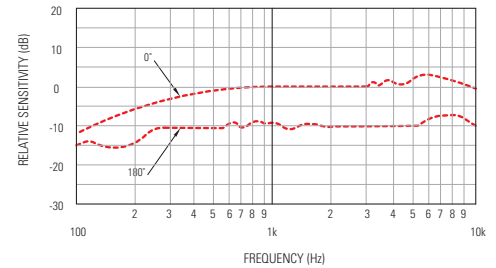

## Noise Canceling – 4 mm, 6 mm, 9.7 mm



Size (mm)	Part Number	Sensitivity (db)	Filter	Termination
4x1.5	MB4015NSC-3	-46.0±3	10pF & 33pF	Solder Type
6x2.2	MB6022NSC-2	-44.0±3	10pF & 33pF	Solder Type
9.7x5.2	MD9752NSZ-1	-40.0±3	None	Solder Type

4x1.5 FREQUENCY RESPONSE

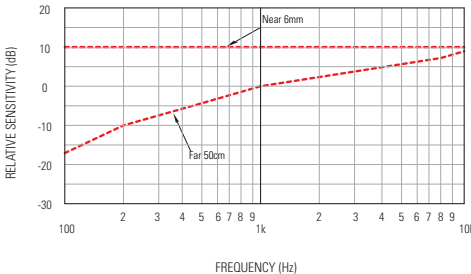

6x2.2 FREQUENCY RESPONSE

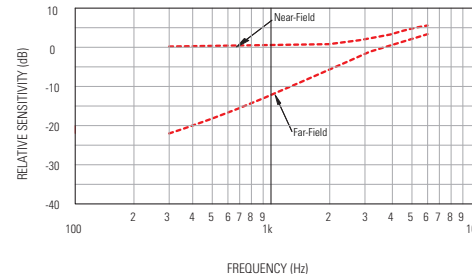

9.7x5.2 FREQUENCY RESPONSE

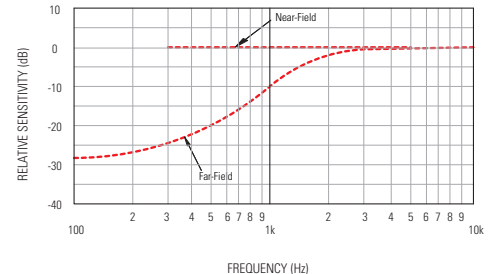

## Value Added Microphone Assemblies

Knowles Acoustics has over 60 years experience with precision assembly for demanding applications. By allowing Knowles to work with your design engineers we are typically able to provide a lower overall cost (time to market, R&D expenses, production scrap and inventory issues) with some of the highest quality standards in the industry.

- Multiple value added models with cable wire leads and connectors along with rubber boot housings that all meet current RoHS standards are available
- Outsource your existing assembly that contains a Knowles component, and maintain control of drawings and process
- Meet Halogen Free and GREEN standards

Notes:

1. All sensitivities are referenced at 1 kHz (1V/Pa)
2. Frequency graphs are typical. Contact manufacturer for more detailed information.



# SPECIALTY TRANSDUCERS — Microphones

## Specialty Transducer Microphones

The Specialty Transducer (ST) product line consists of miniature microphones, speakers, and assemblies. Hundreds of design possibilities can be applied to your product challenge with our high-performance microphone designs. Ideal for new product ideas that require premium audio and very small form factors, solutions include noise canceling, omni-directional and unidirectional performance. Other variables include size, shape, amplification, sensitivity, low noise, and resistance to vibration and mechanical shock.

ST components and assemblies are unique in fit, form and function. Our products are designed into high value applications in markets such as the following:

- Communications – headsets, handsets, earpieces, telephony, voice recognition, emergency services, military, surveillance
- Pro audio – in-ear speakers, lapel microphones, boom microphones
- Medical and more – sensors, audiometers, medical implants



## FG SERIES – Microphone

### Omnidirectional 2.565 DIA x 2.565 (mm)

The FG Series microphone is the world's smallest electret condenser microphone. Its cylindrical shape and compact size facilitate compact designs. The FG can also be used in directional applications as a matched omni-directional pair.



- Smallest microphone option
- High resistance to mechanical shock
- Exceptionally low vibration sensitivity
- Various responses available
- Integral RFI suppression

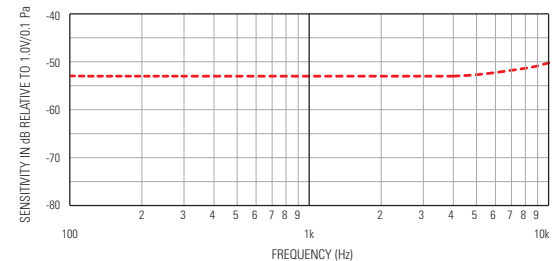

Model	Sensitivity @1kHz (dB re1V/1Pa)	DC Supply (Vdc)	Max. Amplifier Current Drain (uA)	Max. "A" Weighted Noise (1 kHz Equivalent SPL)	Nominal Output Impedance (Ohms)	Comments
FG-23329-C05	-33.0±3	0.9-1.6	50	30.0 dB	4400	RFI Improved Version
FG-23329-P07	-33.0±3	0.9-1.6	50	30.0 dB	4400	3-wire, 1015 mm Shielded Cable
FG-23629-P16	-33.0±3	0.9-1.6	50	28.0 dB	4400	3-wire, 25.4 mm Litz Wires
FG-23629-C36	-33.0±3	0.9-1.6	50	28.0 dB	4400	RFI Improved Version
FG-23652-C36	-33.0±3	0.9-1.6	50	28.0 dB	4400	RFI Improved Version
FG-23652-P16	-33.0±3	0.9-1.6	50	28.0 dB	4400	3-wire, 25.4 mm Litz Wires
FG-23742-D36	-43.0±3	0.9-1.6	50	30.0 dB	4400	3-wire, 25.4 mm Litz Wires
FG-23742-P16	-43.0±3	0.9-1.6	50	36.0 dB	4400	3-wire, 25.4 mm Litz Wires
FG-26163-000	-33.0±3	0.9-1.6	50	93.0 dB	4400	RFI Improved Version

## EM SERIES – Microphone

### Omnidirectional 3.63 x 3.63 x 2.28 (mm)

The EM is a popular, alternative omni-directional microphone. The EM can also be used in directional applications as a matched omni-directional pair.

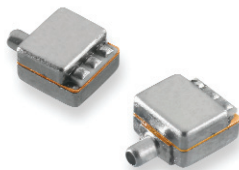

- High resistance to mechanical shock
- Improved RFI and EMI
- Undamped, screen damped, and internally damped responses
- Numerous port locations
- Wide range of frequency responses

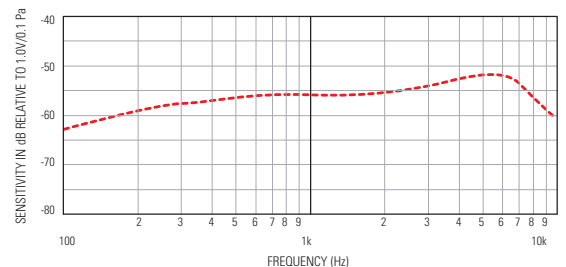

Model	Sensitivity @1kHz (dB re1V/1Pa)	DC Supply (Vdc)	Max. Amplifier Current Drain (uA)	Max. "A" Weighted Noise (1 kHz Equivalent SPL)	Nominal Output Impedance (Ohms)	Comments
EM-23046-P16	-36.0±3	1.3	50	31.0 dB	4400	3-wire, 25.4 mm Shielded Cable
EM-23069-000	-36.0±3	1.3	50	33.0 dB	4400	Tubeless

Note: All performance curves are typical

# SPECIALTY TRANSDUCERS — Microphones

## EK/EL SERIES – Microphone

### Omnidirectional (EK), Unidirectional (EL) 4.00 x 5.59 x 2.28 (mm)

EK omnidirectional microphones provide a unique combination of size, performance and value. Its high electroacoustic sensitivity and low noise make this microphone an excellent choice for applications where space allows. These popular microphones are available in many model varieties.



- High resistance to mechanical shock
- Available with RFI suppression
- Various port locations available
- Wide range of frequency responses
- High S/N performance

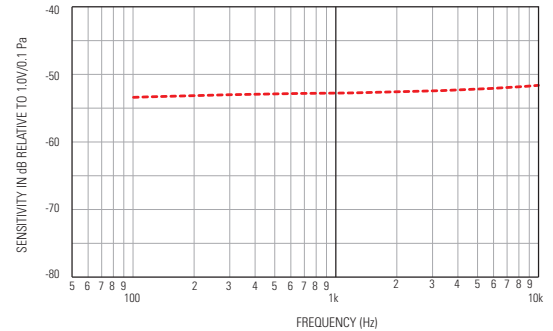

Model	Sensitivity @1kHz (dB re1V/1Pa)	DC Supply (Vdc)	Max. Amplifier Current Drain (uA)	Max. "A" Weighted Noise (1 kHz Equivalent SPL)	Nominal Output Impedance (Ohms)	Comments
EK-23024-C36	-33.0±2	0.9-10	50	26.0 dB	4400	RFI Improved Version
EK-23024-P07	-33.0±2	0.9-10	50	26.0 dB	4400	3-wire, 1 m Shielded Cable
EK-23027-C36	-33.0±2	0.9-10	50	100.0 dB	4400	RFI Improved Version
EK-23028-C36	-37.0±3	0.9-10	50	100.0 dB	4400	RFI Improved Version
EK-23033-C36	-33.0±2	0.9-10	50	26.0 dB	4400	RFI Improved Version
EK-23132-000	-33.0±2	0.9-10	50	26.0 dB	4400	
EK-23133-C36	-33.0±2	0.9-10	50	26.0 dB	4400	RFI Improved Version
EK-23142-C37	-33.0±2	0.9-10	50	26.0 dB	4400	RFI Improved Version
EL-23078-000	-33.0±2	0.9-10	50	31.0 dB	4400	

## NR SERIES – Microphone

### Noise Canceling 4.00 x 5.59 x 2.28 (mm)

The NR Series close talking microphones deliver state-of-the-art noise canceling performance. NR microphones are used as headset microphones in the most demanding communication and speech recognition environments. The NR Series microphones are available in boom microphone packages. (See the FB Series and PNR/PWP Series for details.)



- Integral FET amplifier
- Diaphragm responds to pressure differential giving high rejection of background noise
- Withstands severe environmental conditions
- Low vibration sensitivity
- High electroacoustical sensitivity
- Superior noise canceling performance
- Lead attachment available

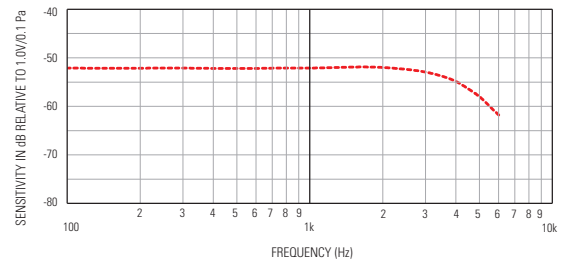

Model	Sensitivity @1kHz (dB re1V/1Pa)	DC Supply (Vdc)	Max. Amplifier Current Drain (uA)	Max. "A" Weighted Noise (dBV)	Nominal Output Impedance (Ohms)	Comments
NR-23158-000	-38.0±3	1.3	50	-100	4400	3-wire
NR-23159-000	-52.0±3	1.3	200	-100	2500	2-wire
NR-23160-000	-44.0±3	1.3	50	-100	4400	2-wire
NR-25994-000	-38.0±3	1.3	700	-100	4400	3-wire

# SPECIALTY TRANSDUCERS — Microphones

## BJ SERIES – Microphone

### Omnidirectional, Noise Canceling 7.92 x 5.70 x 4.14 (mm)

Knowles' Magnetic Microphones (BJ Series) are based on balanced armature technology and are self-shielded against external magnetic fields. The microphones offer high efficiency, stability, and reliability and are small in size. The diaphragm of the BJ Series responds to pressure differential, giving high rejection of background noise. Both face and edge ports are offered. In addition, there is a short distance between front and back ports resulting in improved noise rejection up to higher frequencies.



- *Balanced armature technology*
- *High efficiency, stability and reliability*
- *Self-shielded against external magnetic fields*
- *Face and edge ports*
- *Diaphragm responds to pressure differential giving high rejection of background noise*
- *Short distance between front and back ports resulting in improved noise rejection up to higher frequencies*

Model	Directivity	Port Location	Nominal Impedance at 1kHz (Ohms)	Nominal DC Resistance at 20° C (Ohms)
BJ-21590-000	Omnidirectional	OJn	3900	900
BJ-28411-000	Noise Canceling	Dual	300	75.5

## BL SERIES – Omnidirectional Microphone

Knowles' Piezo Ceramic Microphones (BL Series) are rugged, stable and versatile. BL microphones are available in three different package sizes: standard, thin or 0.5" cylindrical shell and cable assembly. Both communication and broadband frequency response versions are offered. In addition, BL microphones have high vibration sensitivity and may be used as accelerometers.



- *High sensitivity*
- *Wide frequency range*
- *Integral FET amplifier*
- *High resistance to mechanical shock*
- *Various responses*
- *Two case sizes available*

Model	Dimensions	Sensitivity @ 1kHz (dB re1V/1Pa)	DC Supply (Vdc)	Max. Amplifier Current Drain (uA)	Max. "A" Weighted Noise (1 kHz Equivalent SPL)	Nominal Output Impedance (Ohms)	Comments
BL-21671-000	7.9 x 5.6 x 4.1	-34.5±3	1.3	50	32.0 dB	13000	
BL-21671-140	7.9 x 5.6 x 4.1	-34.5±4	1.3	50	32.0 dB	13000	Faster Overpressure Recovery
BL-21785-000	7.9 x 5.6 x 2.3	-49.0±3	3	160	34.0 dB	4000	
BL-21994-000	25.4 x 12.7 DIA	-49.0±3	3	160	34.0 dB	4000	965 mm Shielded Cable
BL-23497-000	25.4 x 12.7 DIA	-49.0±3	3	160	34.0 dB	4000	34.3 mm Leads
BL-27046-000	7.87 x 5.54 x 2.23	-49.0±3	1.3	160	34.0 dB	4000	

# SPECIALTY TRANSDUCERS — Microphones

## WP SERIES – Waterproof Microphone

### Omnidirectional, Noise Canceling 4.00 x 5.59 x 2.28 (mm)

Knowles' waterproof microphones survive immersion in water. The WP Series' form factor is a very small size with low vibration sensitivity. The excellent noise canceling performance is useful for sensors and instrumentation. The WP Series are available in boom microphone packages. (See the FB Series and PNR/PWP Series for details.)



- Waterproofed to submersion in 1m water
- Close-talking (noise-canceling)
- Corrosion resistant
- Withstands explosive decompression
- Excellent environmental performance
- High resistance to mechanical shock

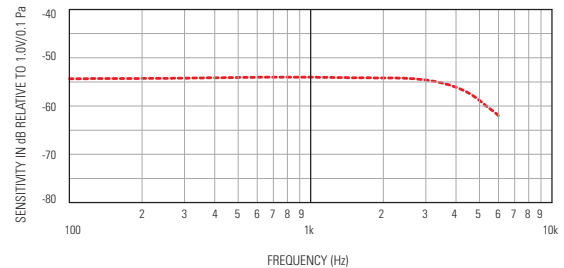

Model	Sensitivity @1kHz (dB re1V/1Pa)	Directivity	DC Supply (Vdc)	Max. Amplifier Current Drain (uA)	Max. "A" Weighted Noise (dBV)	Nominal Output Impedance (Ohms)	Comments
WP-23501-000	-34.0±3	Noise Canceling	1.3	300	-100	2500	2-wire, Waterproof
WP-23502-000	-32.0±3	Omnidirectional	1.3	50	-100	4400	3-wire, Waterproof
WP-23502-P07	-32.0±3	Omnidirectional	1.3	50	-100	4400	3-wire, 1 m Shielded Cable
WP-23502-P16	-32.0±3	Omnidirectional	1.3	50	-100	4400	3-wire, 25.4 mm Litz Wires
WP-23849-C36	-32.0±3	Omnidirectional	1.3	50	-100	4400	RFI Improved + Extended Response

## MR SERIES – Waterproof Microphone

### Omnidirectional 22.12 DIA x 9.3 (mm)

The MR Series Assemblies consist of a microphone element attached to a waterproof bellows assembly. They may be panel mounted, attached for boom applications, and are suitable for outdoor use or repeated submersion.



- Highly waterproof – no loss of performance after immersion in 15-20 m water
- Corrosion resistant
- Withstands explosive decompression
- Design proven in rugged environments
- Cable wire attached
- High resistance to mechanical shock
- Acoustically transparent bellows
- Resists effects of mud, sand, and salt encrustation

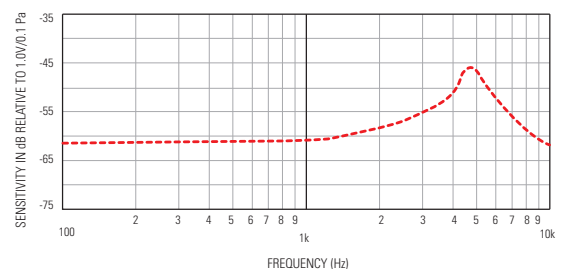

Model	Sensitivity @1kHz (dB re1V/1Pa)	DC Supply (Vdc)	Max. Amplifier Current Drain (uA)	Max. "A" Weighted Noise (1 KHz Equivalent SPL)	Nominal Output Impedance (Ohms)	Comments
MR-23151-000	-67.5±3	N/A	N/A	30.0 dB	300	2-wire, 193 mm Leads, Waterproof to 20 m
MR-23793-000	-40.0±4	1.3	100	31.0 dB	2500	3-wire, 201 mm Leads, Waterproof to 20 m
MR-28406-000	-40.0±3	1.3	50	30.0 dB	3500	3-wire, 202 mm Leads, Waterproof to 20 m

# SPECIALTY TRANSDUCERS — Microphones

## FB SERIES – Boom Microphone

FB Series are available in metallic, flexible boom styles, which utilize a wide array of microphone elements, giving superb noise rejection and high-frequency crossover of near and far field responses. FB's are utilized in a variety of aircraft audio systems and radio communication helmets. Knowles offers customized lengths and end terminations to meet your application needs.



- No loss of performance after submersion in 1m water
- Excellent environmental performance
- Includes RF screening — meets the 2v/m test over the frequency range 1 to 20 MHz
- Metallic, double-spirally-wound, flexible booms which allow easy adjustment and maintain the microphone in an optimum acoustic position above the top lip, or close to the side of the mouth
- 4mm and 6mm diameter boom options

Model	Microphone Element	Directivity	Microphone Configuration	Nominal Boom Diameter (mm)	Boom Length Tip-To-Tip (mm)	Termination
FB-23511-000	WP-23500-000	Noise Canceling	3-WIRE	4	160	Bare End
FB-23225-000	NR-23160-000	Noise Canceling	2-WIRE	6	164	6mm Threaded Connector
FB-25946-000	WP-23501-000	Noise Canceling	2-WIRE	4	74	Bare End
FB-25624-000	WP-23501-000	Noise Canceling	3-WIRE	5	163	Bare End

## PNR/PWP SERIES – Boom Microphone

PNR/PWP Series are available in plastic, rigid booms, which utilize either the WP or NR microphone element, giving superb noise rejection and high-frequency crossover of near and far field responses. The boom microphones are utilized in a variety of aircraft audio systems and radio communication helmets. Knowles offers customized lengths and end terminations to meet your application needs.



- PWP utilizes the WP Series of electret, close-talking microphones with the same acoustic characteristics as the NR series, but with the addition feature of waterproofing to withstand submersion in 1m water
- The housings of the NR Series and WP Series microphones are attached to plastic tubing, which can be customized to a particular length
- The overall PNR and PWP packages are extremely lightweight, small and unobtrusive

Model	Microphone Element	Directivity	Microphone Configuration	Nominal Boom Diameter (mm)	Boom Length Tip-To-Tip (mm)	Termination
PNR-23539-000	NR-23160-000	Noise Canceling	2-WIRE	4	120	Leads
PNR-23868-000	NR-25997-C97	Noise Canceling	2-WIRE	NO BOOM	N/A	Housing Only w/ Leads (No Boom)
PNR-23249-000	NR-23160-000	Noise Canceling	2-WIRE	4	130	Gooseneck Boom



# SPECIALTY TRANSDUCERS — Accelerometers & Dampers

## BU SERIES – Accelerometer 7.87 x 5.54 (mm)

BU Series Accelerometers are frequently used as contact microphones for radio communications in high noise environments such as firefighting or combat. The accelerometers reproduce voice signals from vibrations at the throat or from bony parts of the head, and are compatible with helmet or headset applications.



- Ceramic vibration transducer
- High vibration sensitivity
- Small size
- Wide frequency range
- Integral FET amplifier
- High resistance to mechanical shock
- Withstands severe environmental conditions

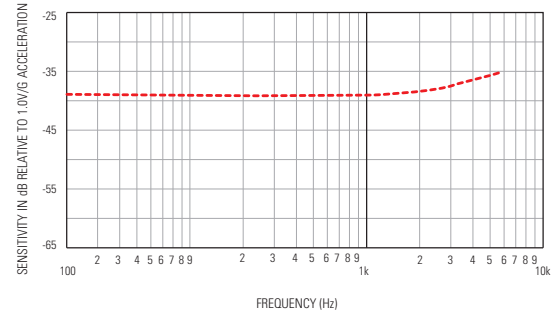

Model	Thickness	Sensitivity @ 1KHz (db re 1V/g)	DC Supply (V)	Max. Current Drain (uA)	Nominal Output Impedance @1 KHz (Ohms)	"A" Weighted Noise (dBre. 1V)
BU-21771-000	4.06	-45.0±4.5	1.5	50	5200	-103
BU-23173-000	4.06	-39.0±4.5	1.5	50	5200	-103
BU-23842-000	2.24	-40.0±4.0	1.5	50	5200	-103
BU-27135-000	2.24	-45.0±4.5	1.5	300	5200	-103

## BF Series – Acoustic Dampers

Dampers are acoustic cloth screens for insertion inside acoustic tubing. These damping elements are used between the speaker outlet and the ear canal to smoothen the frequency response.



- Smoothen and shape frequency response
- Various acoustical resistances and sizes

Model	Color	Nominal Acoustic Resistance (Ohms)	PLUG (mm)	SCREEN (mm)
BF-1859-000	White	680	2.08	--
BF-1860-000	Brown	1000	2.08	--
BF-1861-000	Green	1500	2.08	--
BF-1921-000	Red	2200	2.08	--
BF-1922-000	Orange	3300	2.08	--
BF-1923-000	Yellow	4700	2.08	--
BF-1988-000	White	680	--	1.12
BF-1991-000	Green	1500	--	1.12
BF-1995-000	Red	2200	--	1.12
BF-1997-000	White	680	--	1.78
BF-1999-000	Grey	330	2.08	--
BF-3034-000	Grey	330	--	1.78
BF-3035-000	Brown	1000	--	1.78
BF-3036-000	Orange	3300	--	1.78
BF-3037-000	Red	2200	--	1.78
BF-3038-000	Green	1500	--	1.78
BF-3039-000	Green	1500	--	1.37
BF-3163-000	Yellow	4700	--	1.12

# SPECIALTY TRANSDUCERS — Speakers

## Specialty Transducer Speakers

Knowles sub-miniature speaker designs are based on balanced armature technology and are utilized in a variety of high performance audio and communication products. Knowles balanced armature speakers are available in several sizes and efficiencies, which can be finely tuned to meet your specific performance requirements. They are designed for use in in-ear applications, including earphones and communication earpieces, or be sub-assembled by Knowles for premium consumer electronics accessories.

- High efficiency, stability and reliability
- Customizable performance and port locations
- Ideal for premium in-ear designs
- Component and subassembly solutions



### TWFK SERIES – Dual Balanced Armature Speaker 5.00 x 2.73 x 3.86 (mm)

The world's smallest dual balanced armature speaker, the TWFK is designed for pro-audio in-ear applications. Enables customized cross-over systems to achieve target frequency response in a package size smaller than the ED Series.



- Single sound port for simplified earphone design
- Extreme wideband frequency response
- Unique woofer/tweeter combination
- Enables leading-edge earphone designs for size and performance

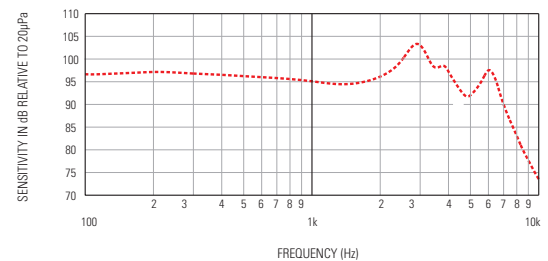

Model	Sensitivity @ 1kHz (dB SPL)	Port Location	Impedance @ 500Hz (Ohms)	Max SPL @ 500Hz (dB SPL)	Max SPL @ 1st Peak (dB SPL)
TWFK-30017-000	95	12S	31	106	113

### WBFK SERIES – Wideband Balanced Armature Speaker 5.00 x 2.73 x 1.93 (mm)

Same package size as FK Series, WBFK has extended high frequency response. It is recommended as a high frequency component to be combined with low/midrange speaker for music earphones.

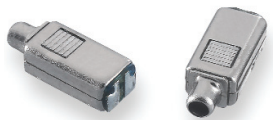

- Lower low/mid-band sensitivity compared to FK Series
- Best high frequency response of any Knowles element
- Combine with low/mid-range speaker for extended frequency response
- TWFK pairs WBFK with low frequency FK

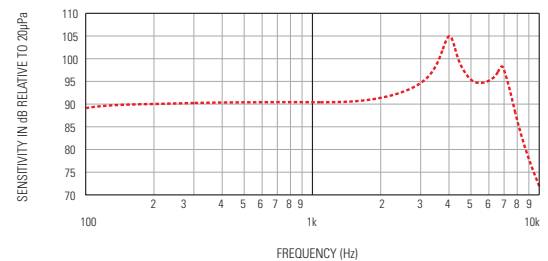

Model	Sensitivity @ 1kHz (dB SPL)	Port Location	Impedance @ 500Hz (Ohms)	Max SPL @ 500Hz (dB SPL)	Max SPL @ 1st Peak (dB SPL)
WBFK-30095-000	91	12S	13.5	101	114

# SPECIALTY TRANSDUCERS — Speakers

## FK SERIES – Balanced Armature Speaker 5.00 x 2.73 x 1.93 (mm)

The world's smallest balanced-armature speaker, the FK Series is designed for applications where size is the most important design concern.

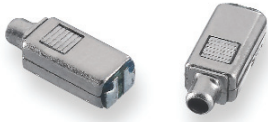

- 114dB SPL maximum output
- Two-terminal zero-bias configuration
- Undamped, screen damped, and internally damped responses
- Wide range of coil impedances

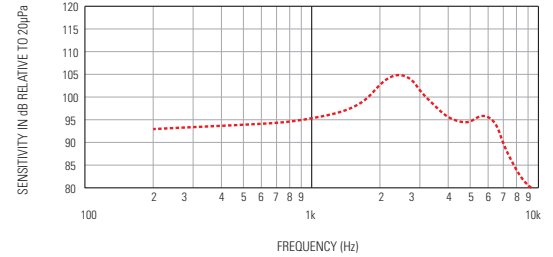

Model	Sensitivity @ 1kHz (dB SPL)	Port Location	Impedance @ 500Hz (Ohms)	Max SPL @ 500Hz (dB SPL)	Max SPL @ 1st Peak (dB SPL)
FK-23451-000	95.5	12S	450	104.5	118.5
FK-23466-000	95.5	12S	450	104.5	118.5
FK-26260-000	96	12S	180	104.5	115.5

## FH SERIES – Balanced Armature Speaker 5.09 x 2.80 x 2.59 (mm)

The FH speaker represents an unprecedented combination of ultra-compact size and high SPL output with efficiencies normally found only in much larger speakers. The FH speaker line brings true high-gain, high-output performance to earphone designs.



- Undamped, screen damped, internally damped, and Ferrofluid™ damped responses
- Various port locations, coil impedances, damping options, termination configurations, and frequency responses available
- Maximum SPL output of 123dB at resonance peak, 109dB at midband (500Hz)\*

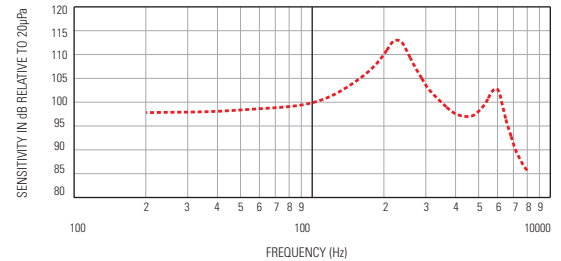

Model	Sensitivity @ 1kHz (dB SPL)	Port Location	Impedance @ 500Hz (Ohms)	Max SPL @ 500Hz (dB SPL)	Max SPL @ 1st Peak (dB SPL)
FH-23375-000	100	12S	335	108.5	123
FH-23377-000	100	12S	685	108.5	123
FH-23821-000	100	12S	174	108.5	123
FH-26553-000	100	12S	90	108.5	123

# SPECIALTY TRANSDUCERS — Speakers

## WBHC SERIES – Balanced Armature Speaker 5.16 x 3.51 x 3.00 (mm)

The advanced design of the HC Series speaker provides extended acoustic bandwidth for hi-fi in-ear speakers when paired with a low frequency speaker.

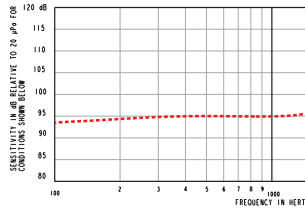

- Lower low/mid band sensitivity compared to HC series
- Combine with low/mid-range speaker for extended frequency response

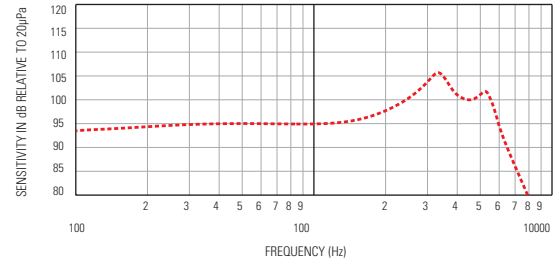

Model	Sensitivity @ 1kHz (dB SPL)	Port Location	Impedance @ 500Hz (Ohms)	Max SPL @ 500Hz (dB SPL)	Max SPL @ 1st Peak (dB SPL)
WBHC-23910-000	95	12C	130	105	115

## HC SERIES – Balanced Armature Speaker 5.16 x 3.51 x 3.00 (mm)

Knowles balanced-armature, magnetic technology to give high efficiency, stability and reliability. HC Series provides increased low frequency dynamic range in a package size equal to FC.



- High-output technology provides double (+3dB) the maximum acoustic output of existing Knowles FC Series speakers
- Maximum output comparable to Knowles' ED Series speaker in a package size only 68% as large!
- Same size and dimensions as Knowles' EH Series
- Ideal for applications where small size and high output is required

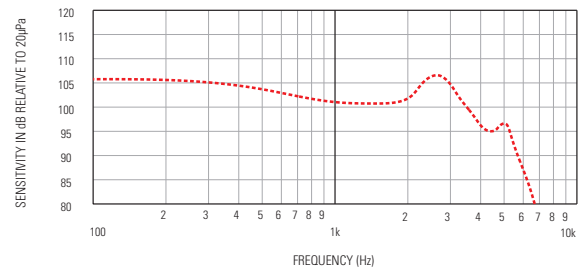

Model	Sensitivity @ 1kHz (dB SPL)	Port Location	Impedance @ 500Hz (Ohms)	Max SPL @ 500Hz (dB SPL)	Max SPL @ 1st Peak (dB SPL)
HC-23761-000	101	12C	8.4	114	116

## FC SERIES – Balanced Armature Speaker 5.18 x 3.55 x 3.00 (mm)

FC Series speakers may be used for small radio communication earphones where ED size does meet package requirements. Rounded corners make it slightly smaller compared to EH Series speakers.



- Available in High-Output HC speaker version
- Two-terminal zero-bias and three-terminal center-tapped configurations
- Undamped, screen damped, internally damped, and Ferrofluid™ damped responses
- Rounded corners for improved fit rates; 10% smaller cross-section compared to EH speaker

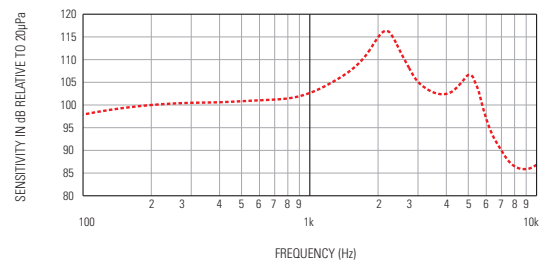

Model	Sensitivity @ 1kHz (dB SPL)	Port Location	Impedance @ 500Hz (Ohms)	Max SPL @ 500Hz (dB SPL)	Max SPL @ 1st Peak (dB SPL)
FC-26171-000	104	12C	170	112	127
FC-26887-000	100	12C	425	110.5	116

# SPECIALTY TRANSDUCERS — Speakers

## EH SERIES – Balanced Armature Speaker 5.19 x 3.55 x 3.00 (mm)

EH Series speakers are approximately 2/3 the size of ED speakers and may be used for small radio communication earphones where ED size does not meet package requirements.



- *Balanced-armature, magnetic technology to give high efficiency, stability and reliability*
- *High sensitivity*
- *Various responses, including standard, damped and modified*
- *Low distortion*
- *Self-shielded for low magnetic radiation*

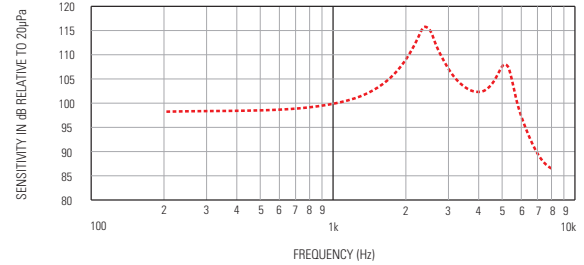

Model	Sensitivity @ 1kHz (dB SPL)	Port Location	Impedance @ 500Hz (Ohms)	Max SPL @ 500Hz (dB SPL)	Max SPL @ 1st Peak (dB SPL)
EH-23030-000	100	12C	625	109	126.5
EH-23149-000	100	12C	110	109	126.5
EH-27479-000	100	12C	150	109	123

## ES SERIES – Balanced Armature Amplified Speaker 5.18 x 3.54 x 3.04 (mm)

EH size speaker with integrated Class D power amplifier



- *EH micro speaker, but with internal, highly-efficient, class D amplifier*
- *Lower current drain prolongs battery life*
- *Lower distortion*
- *Available in a range of SPL ratings*

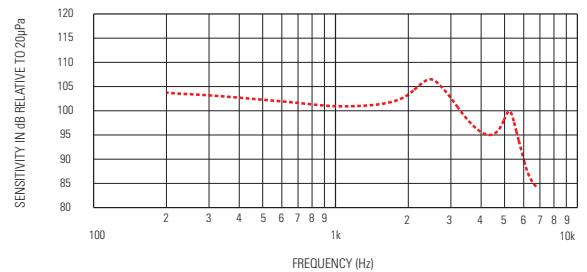

Model	Sensitivity @ 1kHz (dB SPL)	Port Location	Impedance @ 500Hz (Ohms)	Max SPL @ 500Hz (dB SPL)	Max SPL @ 1st Peak (dB SPL)
ES-23127-000	101	12C	50000	112	117.5
ES-23140-000	101	12C	50000	112	115.5

## EP SERIES – Balanced Armature Amplified Speaker 6.32 x 4.29 x 2.99 (mm)

Based on Knowles' versatile and popular ED speaker, the EP series adds the benefits of an internal Class-D amplifier. Its compact size and appreciable output power make the EP speaker suitable for a variety of designs.



- *Class D amplified magnetic speaker*
- *Self-shielded to reduce magnetic radiation*
- *125dB SPL maximum output*
- *Three-terminal electrical connection*

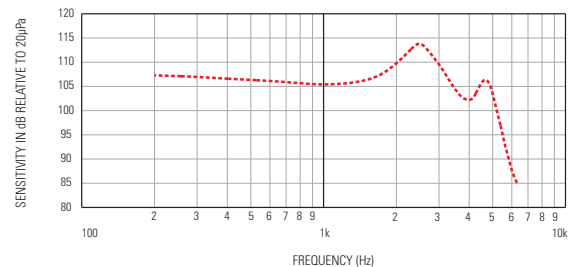

Model	Sensitivity @ 1kHz (dB SPL)	Port Location	Impedance @ 500Hz (Ohms)	Max SPL @ 500Hz (dB SPL)	Max SPL @ 1st Peak (dB SPL)
EP-24075-000	106	12C	50000	116.5	124



# SPECIALTY TRANSDUCERS — Speakers

## FED SERIES – Balanced Armature Speaker 6.32 x 4.31 x 2.47 (mm)

The addition of *Ferrofluid™* to Knowles ED series speakers improves mechanical shock survival and provides peak damping to smooth frequency response.



- *Ferrofluid™* damped with 2dB, 4dB, or 6dB peak amplitude
- Superior shock performance and reduced speaker vibration
- Two-terminal zero-bias and three-terminal center-tapped configurations
- Numerous port locations and coil impedances

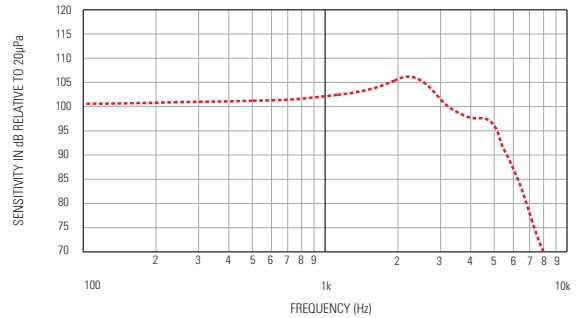

Model	Sensitivity @ 1kHz (dB SPL)	Port Location	Impedance @ 500Hz (Ohms)	Max SPL @ 500Hz (dB SPL)	Max SPL @ 1st Peak (dB SPL)
FED-26792-I04	102.5	12C	65	114.5	116.5
FED-30048-I04	102	12N	26	111.5	116

## ED SERIES – Balanced Armature Speaker 6.32 x 4.31 x 2.97 (mm)

One of Knowles' most versatile and most popular speakers, its compact size and appreciable output power make the ED speaker suitable for a variety of instruments.



- Undamped, screen damped, internally damped, and *Ferrofluid™* damped responses
- Numerous port locations and coil impedances
- High efficiency and low distortion

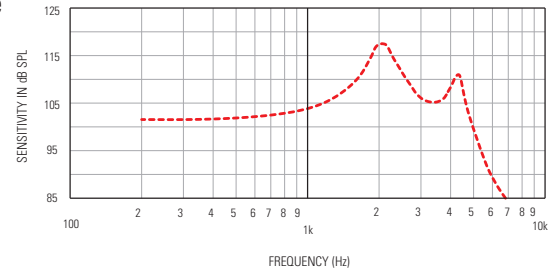

Model	Sensitivity @ 1kHz (dB SPL)	Port Location	Impedance @ 500Hz (Ohms)	Max SPL @ 500Hz (dB SPL)	Max SPL @ 1st Peak (dB SPL)
ED-21744-000	104	12C	1700	111.5	123
ED-21913-000	104	12C	780	112	127
ED-23147-000	102.5	12C	48	110	120.5
ED-23619-000	104	12C	7.1	112	127
ED-23801-000	104	12S	196	112	122
ED-23814-000	104	12S	50	112	128
ED-26245-000	104	12C	55	112.2	122
ED-26598-000	102.5	12C	395	115.5	115.5
ED-26821-000	102.5	12C	7.1	116	120.5
ED-27045-000	104	9C	395	112	127
ED-27230-000	104	12C	79	112	127
ED-27304-000	104	12C	290	111.5	127
ED-29689-000	104	12C	7.1	112	127

# SPECIALTY TRANSDUCERS — Speakers

## EC SERIES – Balanced Armature Speaker 7.57 x 4.31 x 3.67 (mm)

EC Series speakers are commonly used in isolating earphones for radio communication.



- Similar SPL output to the BK Series
- Rounded corners on the face opposite the terminal pad
- 34% smaller volume than the BK Series

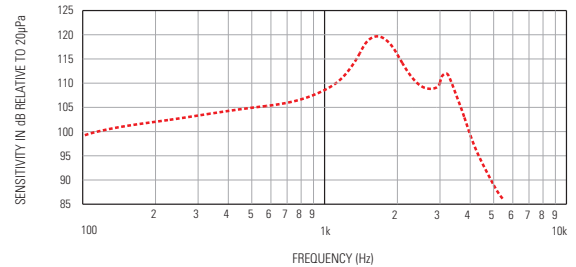

Model	Sensitivity @ 1kHz (dB SPL)	Port Location	Impedance @ 500Hz (Ohms)	Max SPL @ 500Hz (dB SPL)	Max SPL @ 1st Peak (dB SPL)
EC-23097-000	108	12S	200	115	130
EC-23098-000	108	12S	425	115	130
EC-26368-000	108	12S	54	114	129

## TEC SERIES – Balanced Armature Speaker 7.87 x 4.09 x 2.79 (mm)

The TEC combines output comparable to the larger BK speaker in an ultra-thin package. The TEC is suitable for multi-element earphone designs.

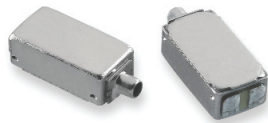

- Ultra-thin
- Wideband output
- DTEC combines two TEC elements
- Enables small multi-element designs

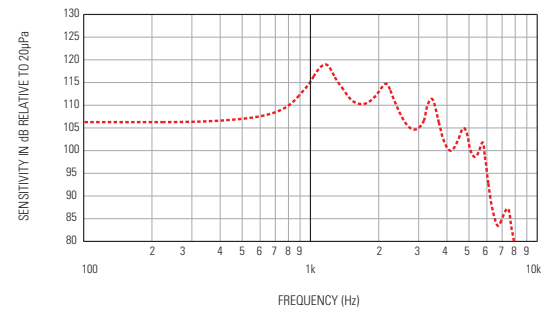

Model	Sensitivity @ 1kHz (dB SPL)	Port Location	Impedance @ 500Hz (Ohms)	Max SPL @ 500Hz (dB SPL)	Max SPL @ 1st Peak (dB SPL)
TEC-30033-000	119	12C	31	117	129

## DTEC SERIES – Balanced Armature Speaker 7.87 x 4.09 x 5.59 (mm)

The DTEC Series combines two TEC speaker elements with a single round port. Case size is equivalent to BK/EF. DTEC provides increased output and reduced vibration compared to a single speaker.



- Dual elements with single sound port
- More output than BK in equal package size
- Reduced vibration compared to BK
- Improved frequency response compared to BK

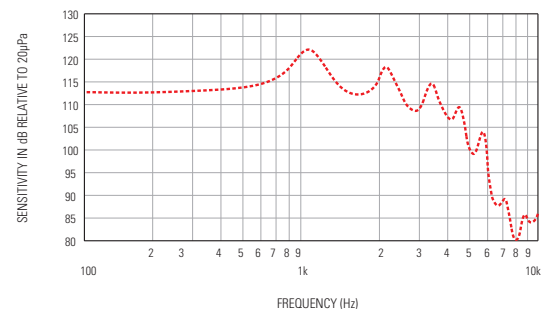

Model	Sensitivity @ 1kHz (dB SPL)	Port Location	Impedance @ 500Hz (Ohms)	Max SPL @ 500Hz (dB SPL)	Max SPL @ 1st Peak (dB SPL)
DTEC-30008-000	121	12S	31.5	123.5	131.5

# SPECIALTY TRANSDUCERS — Speakers

## BK SERIES – Balanced Armature Speaker 7.87 x 5.59 x 4.01 (mm)

BK Series speakers provide broadband performance at value pricing. They are commonly used for full range in-ear speakers and communications utilizing an earplug design.



- High efficiency and low distortion
- Various port locations, coil impedances, damping options, terminal configurations, and frequency responses available

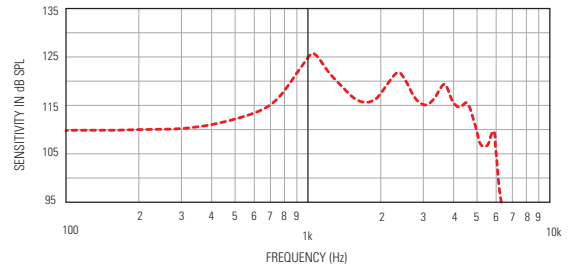

Model	Sensitivity @ 1kHz (dB SPL)	Port Location	Impedance @ 500Hz (Ohms)	Max SPL @ 500Hz (dB SPL)	Max SPL @ 1st Peak (dB SPL)
BK-21600-000	123	12S	285	118	133
BK-21604-000	123	12S	2320	118	133
BK-21610-000	121	12S	60	126.5	136
BK-21613-000	118	1S	450	118	134
BK-21615-000	118	12S	450	118	134
BK-21669-000	123.5	12C	24	118	134
BK-23134-000	118	12S	285	118	134
BK-26824-000	119	12S	16	118	129
BK-28507-000	126	12S	13.3	122.5	136
BK-28510-000	126	12S	320	123	135
BK-28562-000	123	12S	23	119	131
BK-29725-000	118	12S	285	118	128

## CM SERIES – Balanced Armature Speaker 8.38 x 16.64 DIA (mm)

The CM Series delivers the benefits of balanced armature technology in a compact finished package. The CM is ideal for use in situations where a non-contacting headset is required, but signal voltage is limited – as is common for radios and wireless telephones. The CM also conserves battery power, and provides static shock protection for the user.



- Balanced-armature, magnetic technology to give high efficiency, stability and reliability
- High acoustic efficiency enables sufficient sound output even when limited power is available
- In-built static protection
- Lightweight, matt-black, plastic housing
- Ergonomically designed with rounded edge to fit the concha
- High-quality sound output
- Tailored bandwidth for superb speech intelligibility

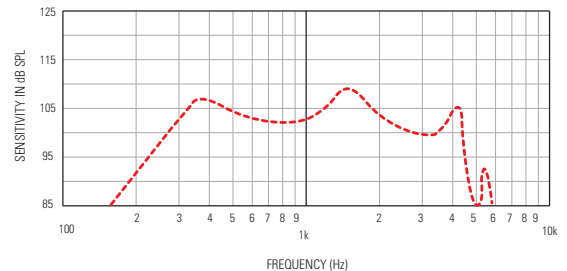

Model	Sensitivity @ 1kHz (dB SPL)	Port Location	Impedance @ 500Hz (Ohms)	Max SPL @ 500Hz (dB SPL)	Max SPL @ 1st Peak (dB SPL)
CM-23152-000	103	Face	150	114.5	129
CM-23299-000	103	Face	150	114.5	119
CM-28421-000	103	Face	360	114.5	119
CM-28431-000	103	Face	30	114.5	119
CM-28452-000	103	Face	360	114.5	119

# SPECIALTY TRANSDUCERS — Speakers

## SR SERIES – Balanced Armature Speaker 8.84 DIA x 5.00 (mm)

At 8.8mm diameter, the SR is the first round balanced armature speaker in the marketplace. SR offers output equivalent to the BK series and maximizes bass performance.



- Round package facilitates earphone designs
- Drop-in upgrade for moving coil dynamic speakers
- Designed for high volume production
- Balanced armature technology

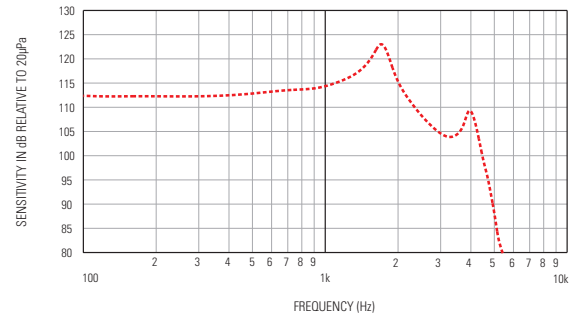

Model	Sensitivity @ 1kHz (dB SPL)	Port Location	Impedance @ 500Hz (Ohms)	Max SPL @ 500Hz (dB SPL)	Max SPL @ 1st Peak (dB SPL)
SR-8850NSS-000	113	Face	37	124.5	130.5
SR-8850NWS-000	114.5	Face	21.5	123	132

## CI SERIES – Balanced Armature Speaker 9.47 x 7.18 x 4.10 (mm)

Knowles' largest and most powerful speaker, the CI series is the speaker of choice. With its high efficiency and a 143dB SPL maximum output, the CI speaker provides optimal low frequency performance.



- Two-terminal zero-bias and three-terminal center-tapped configurations
- Various port locations, coil impedances, termination configurations, and frequency responses available

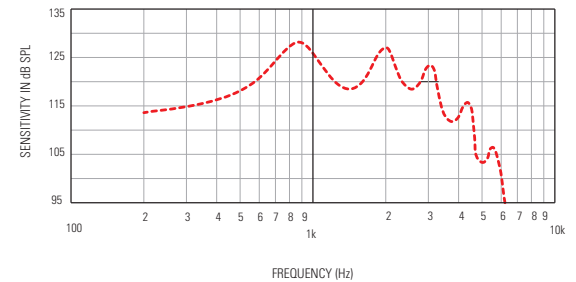

Model	Sensitivity @ 1kHz (dB SPL)	Port Location	Impedance @ 500Hz (Ohms)	Max SPL @ 500Hz (dB SPL)	Max SPL @ 1st Peak (dB SPL)
CI-22748-000	125	12C	250	128.5	138.5
CI-22762-000	125	1S	175	128.5	138.5
CI-22955-000	125	12C	68 @ 1kHz	128.5	138.5
CI-22960-000	125	12C	400	128.5	138.5
CI-28487-000	125	1S	100 @ 1kHz	128.5	138.5
CI-28597-000	125	11S	68 @ 1kHz	128.5	138.5

# SPECIALTY TRANSDUCERS — Speakers

## MR SERIES – Waterproof Speaker 22.12 DIA x 9.3 (mm)

The MR Series Assemblies consist of a speaker element attached to a waterproof bellows assembly. They may be panel mounted, and are suitable for outdoor use or repeated submersion.



- Highly waterproof – no loss of performance after immersion in 15m water
- Corrosion resistant
- Withstands explosive decompression
- Design proven in rugged environments
- Leads attached
- High resistance to mechanical shock
- Acoustically transparent bellows
- Resists effects of mud, sand, and salt encrustation

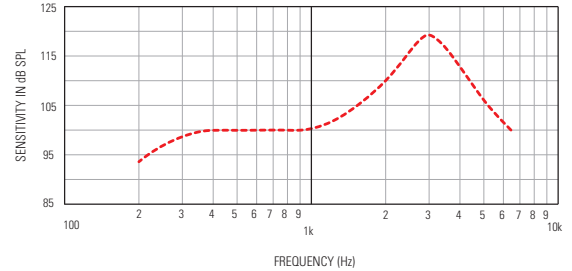

Model	Sensitivity @ 1kHz (dB SPL)	Port Location	Impedance @ 500Hz (Ohms)	Max SPL @ 500Hz (dB SPL)	Max SPL @ 1st Peak (dB SPL)
MR-23333-000	100	Face	21	110	129

## CB SERIES – Balanced Armature Speaker 25.15 x 25.15 x 9.65 (mm)

The CB Series Transceiver offers high electro-acoustic efficiency to conserve power in push-to-talk radio handsets and other battery operated equipment. The CB is available with mounting pins to facilitate assembly to a PC board. Model CB-23817-000 is designed to survive submersion in water.



- Excellent sound quality
- High speech intelligibility, stability, and reliability
- Suitable for PCB mounting
- Can function as a microphone or beeper
- Various impedances
- Face and edge port locations available

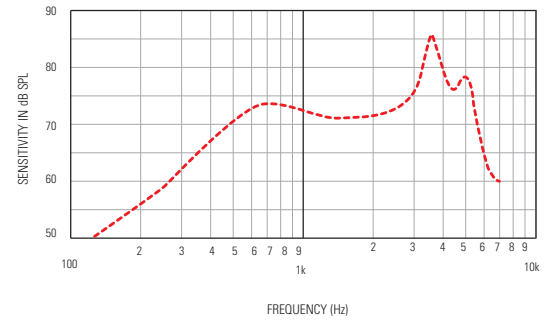

Model	Sensitivity @ 1kHz (dB SPL)	Port Location	Impedance @ 500Hz (Ohms)	Max SPL @ 500Hz (dB SPL)	Max SPL @ 1st Peak (dB SPL)
CB-22849-000	73	Edge	24	80.5	96.5
CB-22850-000	73	Edge	48	80.5	96.5
CB-23817-000	83	Edge	48	95	107



# CUSTOM ASSEMBLIES

## FINISHED GOODS

Wherever your design ideas take you, Knowles Acoustics can support your need for customized audio assemblies. Our custom Finished Goods offer a turnkey solution utilizing the acoustic expertise and components of Knowles Acoustics.

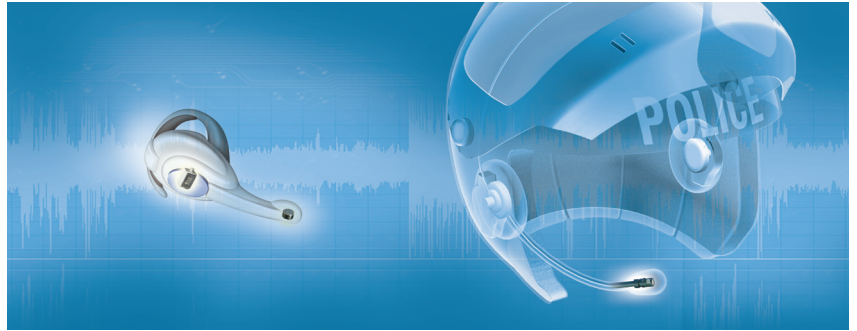

## COMPLETE SOLUTION

Knowles Acoustics Finished Goods program offers reduced time to market at an ultimately reduced total manufacturing cost of acoustic product ownership. Support in design, application, assembly and testing are all elements included in our services. Off-the-shelf designs are also available.



### Design Support

- Industrial
- Mechanical
- Application Tuning



### Manufacturing Services

- Assembly
- Cabling
- Testing
- Utilization of Knowles Acoustic components

## MARKET APPLICATIONS

Ultimately, our mission is to improve the acoustic interface and simplify the manufacturing process for customers. Our long term acoustic history provides the expertise for markets and customers of:

- Mobile media products
- Industrial communications
- Consumer electronics applications

## MARKET MATRIX

Assembly Designs	MP3	Mobile Phone	Smart Phone/PDA	Notebook	Industrial Comm.
Single Ear		✓	✓		✓
Stereo	✓	✓	✓	✓	✓
Microphone		✓	✓	✓	✓

Collaborate in-depth with Knowles Acoustics to arrive at an integrated component and assembly design to manufacture for you.

## INTELLISONIC™

The intelligibility and use of mobile communications are often impeded by the impact of noise from the immediate environment. IntelliSonic is a software-based speech enhancement technology that when coupled with Knowles' microphones, reduces the effects of reverberation, directionally interfering speech, background noise and annoying acoustic echo.



## COMPLETE SOLUTION – Integrated Systems

When you consider the interdependency of microphone design, acoustic porting, and sound signal conditioning, it's easy to see why Knowles Acoustics has taken an integrated approach to your acoustic system needs.

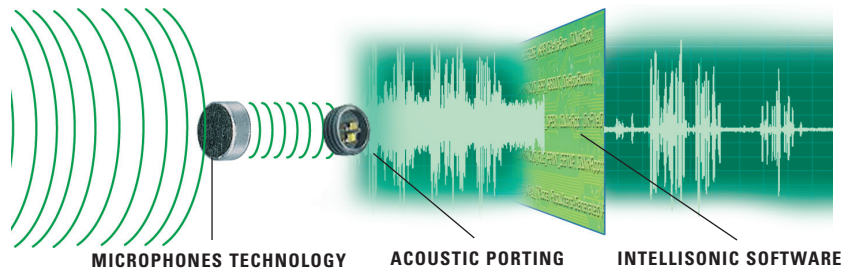

## FEATURES

- Noise suppression 16 dB
- Interference cancellation via beam-forming array 30dB
- Acoustic echo cancellation 27dB
- Speech bandwidth 8kHz
- Adjustable acceptance and look angles
- Fully adaptive system adapts to changing acoustic environment
- Upper filter driver adherent to Microsoft's windows driver model (WDM)
- Rich application programming interface (API) set
- Real-time processing
- Low speech distortion

## APPLICATIONS

Platforms such as tablets, laptops, ultra-mobile personal computers (UPCs), and other mobile computing devices have a number of applications that would benefit from IntelliSonic to enhance the user experience and final product perception.

- VoIP Telephony
- Command and Control
- Voice recognition
- Dictation
- Language Translation
- Voice Annotation
- Audio Note Taking

## PRODUCT MATRIX

Product Code	# of Microphones	Noise Reduction	Acoustic Array	Echo Cancellation
DX01	1	✓	–	–
DX02	2	✓	✓	–
DXEC01	1	✓	–	✓
DXEC02	2	✓	✓	✓

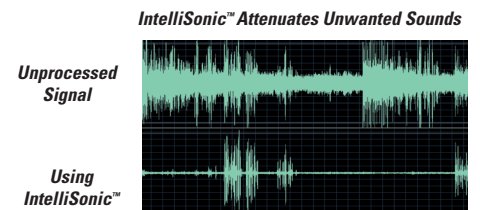

(Visual output of recordings using same microphone)

## LICENSING

A license per end user copy is recommended. This allows access to continued improvements and new releases. The license fee is dependent upon volumes and product platforms.

## SUPPORTED PLATFORMS

- Operating System: Windows® XP/2000 (supports AC'97 and HDAudio), Windows CE

# MICROPHONE AND SPEAKER BASICS

## MICROPHONES

Microphones measure sound pressure. Inside a Knowles microphone is a thin flexible diaphragm, an electrically charged plate, and an amplifier (Fig. 1). The output voltage is proportional to changes in the small separation between the diaphragm and the charged plate (Fig. 2).

As sound pressure inside the front cavity increases, the diaphragm is pushed closer to the plate. As the pressure decreases, it moves further away. The motion of the diaphragm produces a small electrical signal that is amplified by a miniature circuit inside the microphone.

The sensitivity of a typical Knowles' microphone is measured in units of dB relative to 1 Volt per 0.1 Pascal.

**Fig 1: Cross section of a Knowles EM microphone**

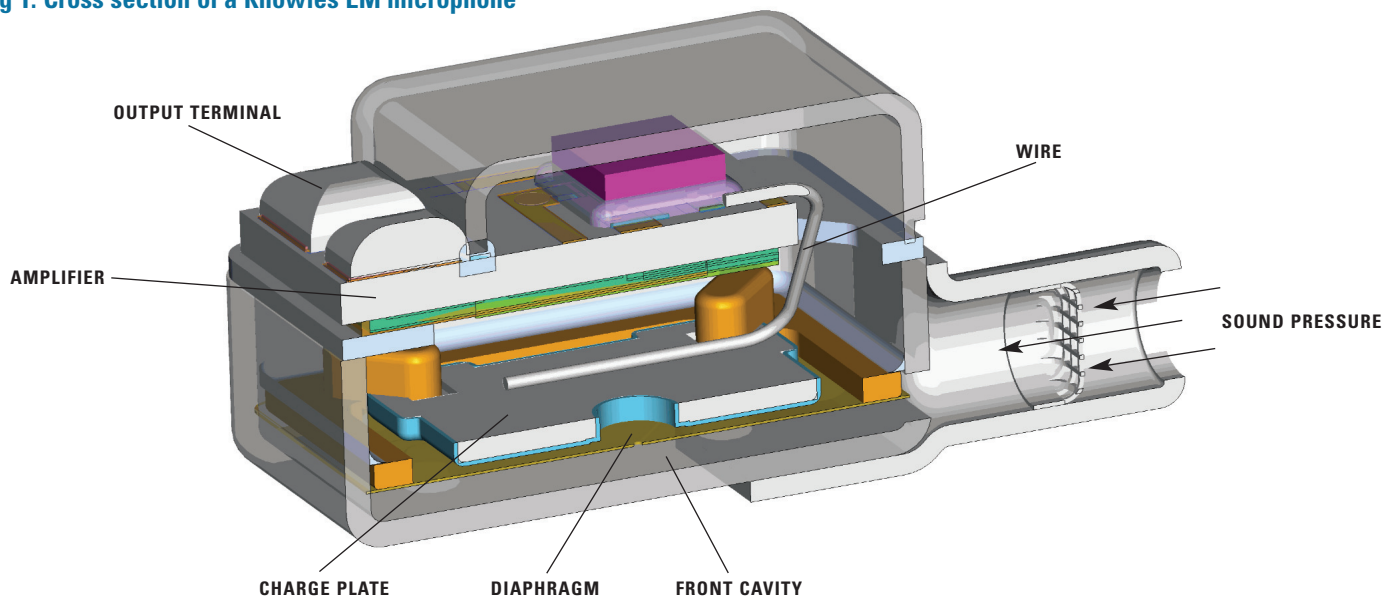

**FIG. 2: EM diaphragm and electret**

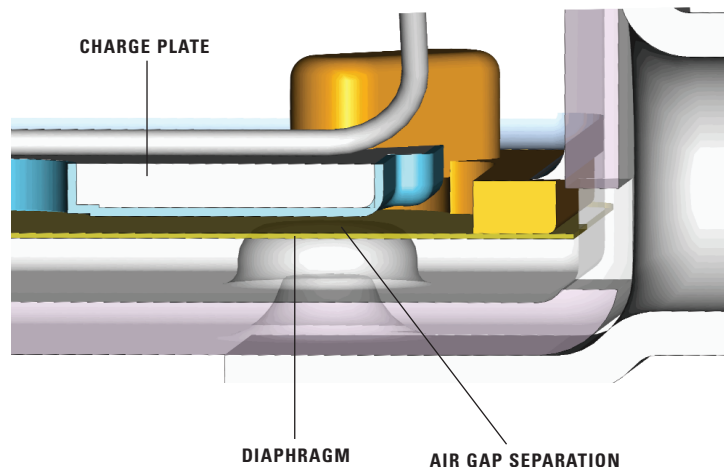

# MICROPHONE AND SPEAKER BASICS

## SPEAKERS

The speaker converts an electrical signal into sound. A cross section of a typical Knowles speaker is shown in Fig. 3. The basic components of the speaker are: a coil of wire, a metal U-shaped reed called the armature, a pair of permanent magnets, a drive rod, and a diaphragm.

The coil and armature act as an electromagnet. An alternating current in the coil causes the polarity of the armature to switch back and forth from north to south. The free end of the armature bends slightly up and down as it is attracted alternately to the top and bottom magnets (Fig. 4). The diaphragm, pulled along by the drive rod, pumps air in and out of the speaker. The mechanical motion of the armature is thus converted into sound.

The sound output of a typical Knowles' speaker is measured in units of dB SPL (sound pressure level) relative to 20  $\mu$ Pa.

**Fig. 3: Cross section of a Knowles EH speaker**

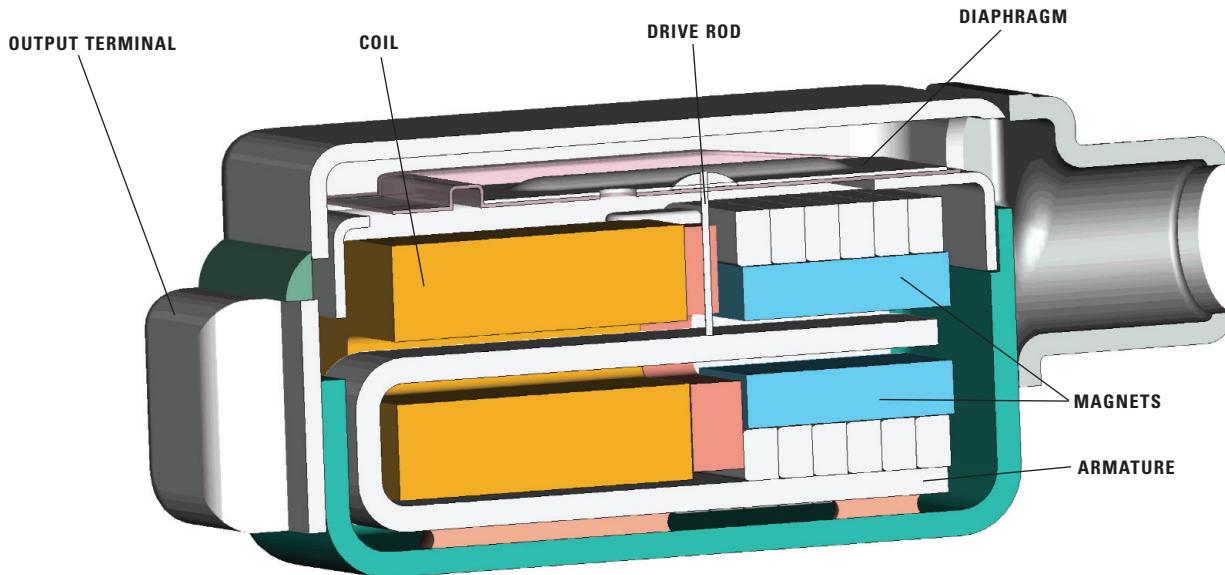

**Fig. 4: The motor of the speaker has a coil, an armature, and a pair of permanent magnets.**

