

**SINGLE-PHASE GLASS PASSIVATED  
SILICON BRIDGE RECTIFIER**  
VOLTAGE RANGE 100 to 1000 Volts CURRENT 0.8 Ampere

**FEATURES**

- \* Surge overload rating - 30 amperes peak
- \* Ideal for printed circuit board
- \* Reliable low cost construction utilizing molded
- \* Glass passivated device
- \* Polarity symbols molded on body
- \* Mounting position: Any

**MECHANICAL DATA**

- \* Epoxy: Device has UL flammability classification 94V-O

**MAXIMUM RATINGS AND ELECTRICAL CHARACTERISTICS**

Ratings at 25 °C ambient temperature unless otherwise specified.  
resistive or inductive load.

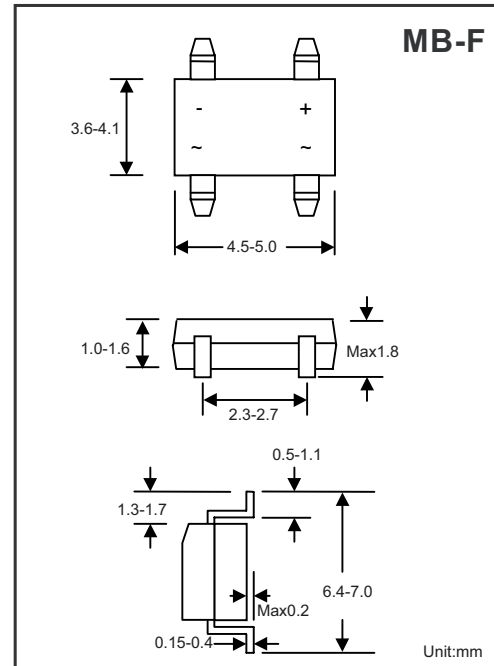

MAXIMUM RATINGS (At  $T_A = 25^\circ\text{C}$  unless otherwise noted)

RATINGS		SYMBOL	MB1F	MB2F	MB4F	MB6F	MB8F	MB10F	UNITS
Maximum Recurrent Peak Reverse Voltage		$V_{RRM}$	100	200	400	600	800	1000	Volts
Maximum RMS Bridge Input Voltage		$V_{RMS}$	70	140	280	420	560	700	Volts
Maximum DC Blocking Voltage		$V_{DC}$	100	200	400	600	800	1000	Volts
Maximum Average Forward Rectified Current	$T_A = 125^\circ\text{C}$	$I_o$	0.5						Amps
	$T_A = 110^\circ\text{C}$		0.8						
Peak Forward Surge Current 8.3 ms single half sine-wave superimposed on rated load (JEDEC method)		$I_{FSM}$	30						Amps
Peak Forward Surge Current 10 ms single half sine-wave superimposed on rated load (JEDEC method)		$I_{FSM}$	27.3						Amps
Typical Current Squared Time		$I^2t$	3.74						$\text{A}^2\text{S}$
Typical Thermal Resistance(Note2)		$R_{\theta JA}$	64						$^\circ\text{C}/\text{W}$
		$R_{\theta JL}$	39						
Operating and Storage Temperature Range		$T_J, T_{STG}$	-55 to + 150						$^\circ\text{C}$

ELECTRICAL CHARACTERISTICS (At  $T_A = 25^\circ\text{C}$  unless otherwise noted)

CHARACTERISTICS		SYMBOL	MB1F	MB2F	MB4F	MB6F	MB8F	MB10F	UNITS
Maximum Forward Voltage Drop per Bridge Element at 0.8 A DC		$V_F$	1.1						Volts
Maximum Reverse Current at Rated DC Blocking Voltage per element	@ $T_A = 25^\circ\text{C}$	$I_R$	1.0						$\mu\text{Amps}$
	@ $T_A = 150^\circ\text{C}$		2						$\text{mAmps}$

NOTES:1. Typical Thermal Resistance : At 9.5mm lead lengths, PCB mounted.

2021-12/18  
REV:G

## RATING AND CHARACTERISTICS CURVES ( MB1F THRU MB10F )

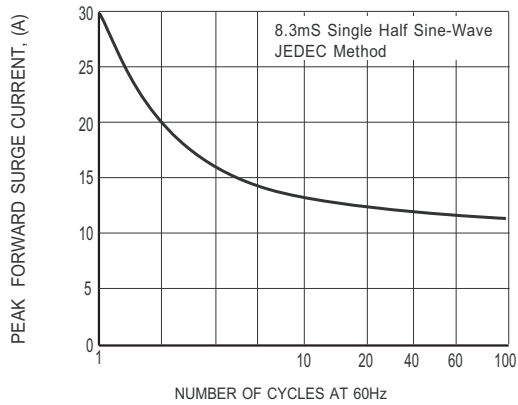

FIG. 1 MAXIMUM NON-REPETITIVE FORWARD SURGE CURRENT

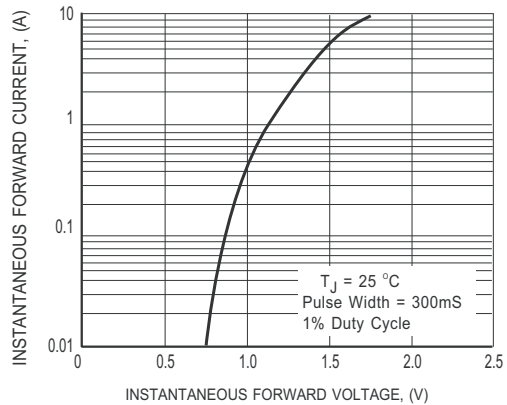

FIG. 2 MAXIMUM INSTANTANEOUS FORWARD CHARACTERISTICS

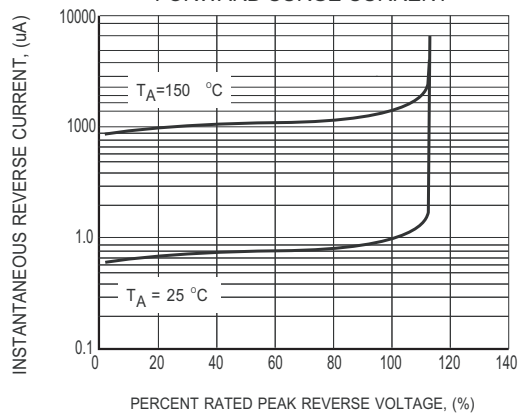

FIG. 3 MAXIMUM REVERSE CHARACTERISTICS

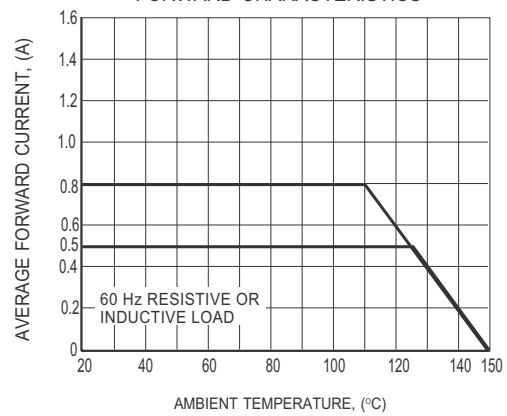
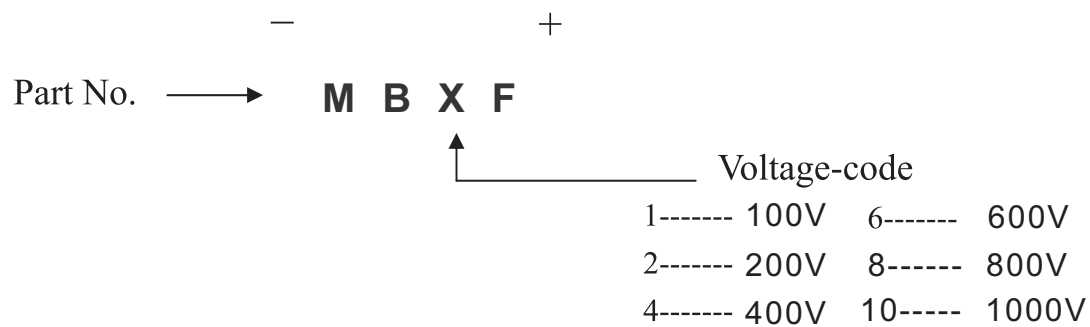
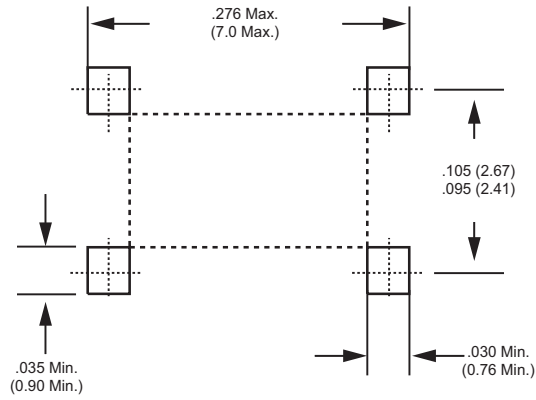

FIG. 4 TYPICAL FORWARD CURRENT DERATING CURVE

## Marking Description



## Mounting Pad Layout



Dimensions in inches and (millimeters)

## PACKAGING OF DIODE AND BRIDGE RECTIFIERS

### REEL PACK

PACKAGE	PACKING CODE	EA PER REEL	EA PER INNER BOX	COMPONENT SPACE (mm)	TAPE SPACE (mm)	REEL DIA (mm)	CARTON SIZE (mm)	EA PER CARTON	GROSS WEIGHT(Kg)
MB-F	-W	5,000	10,000			330	360*335*360	80,000	25.83