



MBR1040DC~MBR10200DC

D²PAK SURFACE MOUNT SCHOTTKY BARRIER RECTIFIERS

VOLTAGE 40 to 200 Volt **CURRENT** 10 Ampere

TO-263 / D²PAK Unit : inch(mm)

FEATURES

- Plastic package has Underwriters Laboratory Flammability Classification 94V-O. Flame Retardant Epoxy Molding Compound.
- Low power loss, high efficiency.
- Low forward voltage, high current capability
- High surge capacity.
- For use in low voltage,high frequency inverters free wheeling , and polarity protection applications.
- Lead free in compliance with EU RoHS 2.0
- Green molding compound as per IEC 61249 standard

MECHANICAL DATA

- Case: D²PAK Molded plastic
- Terminals: Solder plated, solderable per MIL-STD-750, Method 2026
- Polarity: As marked.
- Standard packaging: Any
- Weight: 0.049 ounces, 1.38 grams

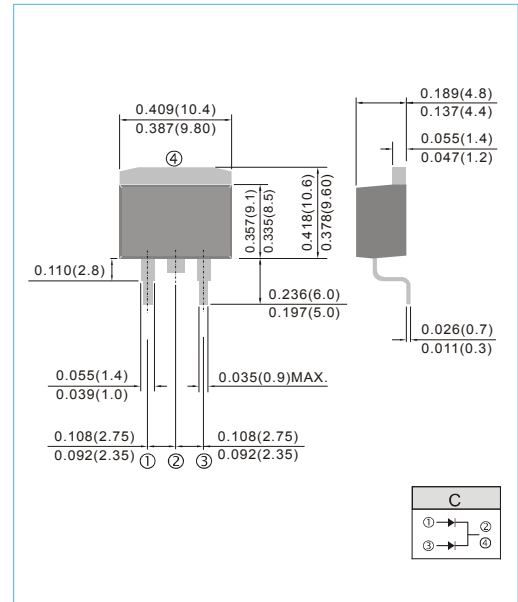

MAXIMUM RATINGS

Ratings at 25°C ambient temperature unless otherwise specified. Single phase, half wave, 60 Hz, resistive or inductive load.
For capacitive load, derate current by 20%

PARAMETER	SYMBOL	MBR1040DC	MBR1045DC	MBR1050DC	MBR1060DC	MBR1080DC	MBR1090DC	MBR10100DC	MBR10150DC	MBR10200DC	UNITS	
Maximum Recurrent Peak Reverse Voltage	V_{RRM}	40	45	50	60	80	90	100	150	200	V	
Maximum RMS Voltage	V_{RMS}	28	31.5	35	42	56	63	70	105	140	V	
Maximum DC Blocking Voltage	V_{DC}	40	45	50	60	80	90	100	150	200	V	
Maximum Average Forward (See Figure 1)	$I_{F(AV)}$	10									A	
Peak Forward Surge Current : 8.3ms single half sine-wave superimposed on rated load	I_{FSM}	150									A	
Maximum Forward Voltage at 5.0A per leg	V_F	0.70		0.75			0.80		0.90		V	
Maximum DC Reverse Current at Rated DC Blocking Voltage $T_J=25^{\circ}C$ $T_J=100^{\circ}C$	I_R	0.05					20				mA	
Typical Thermal Resistance	$R_{\theta JC}$	3.0										$^{\circ}C / W$
Operating Junction and Storage Temperature Range	T_J, T_{STG}	-55 to +150				-65 to +175					$^{\circ}C$	



MBR1040DC~MBR10200DC

RATING AND CHARACTERISTIC CURVES

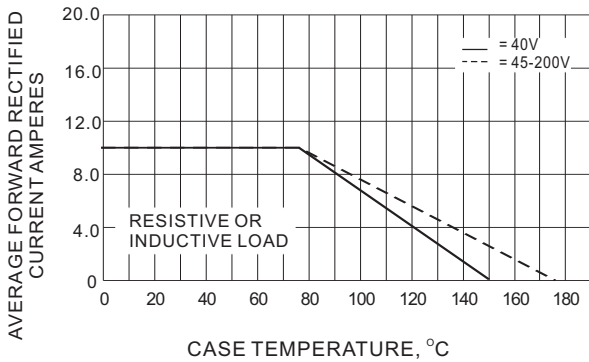

Fig.1 FORWARD CURRENT DERATING CURVE

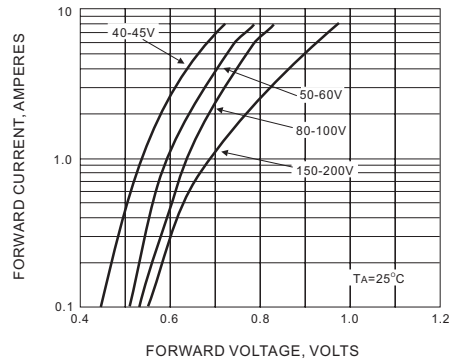

Fig.2 TYPICAL INSTANTANEOUS FORWARD CHARACTERISTIC

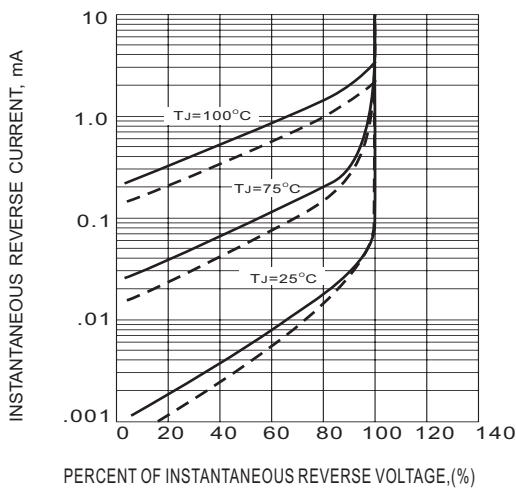

Fig.3 TYPICAL REVERSE CHARACTERISTICS

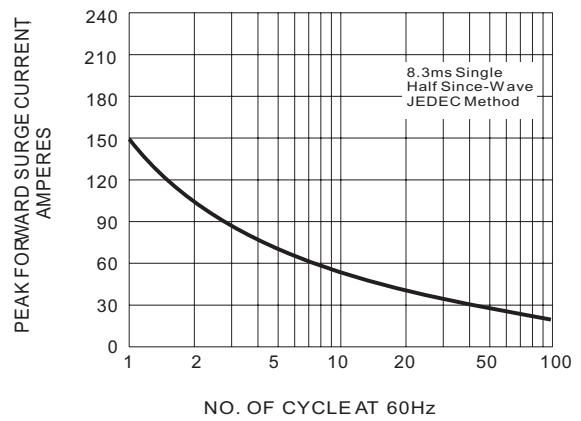

Fig.4 MAXIMUM NON-REPETITIVE SURGE CURRENT

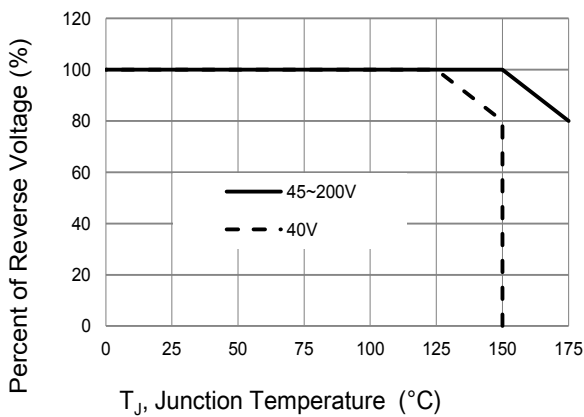

Fig.5 Operating Temperature Derating Curve



MBR1040DC~MBR10200DC

MOUNTING PAD LAYOUT

TO-263 / D²PAK

Unit : inch(mm)

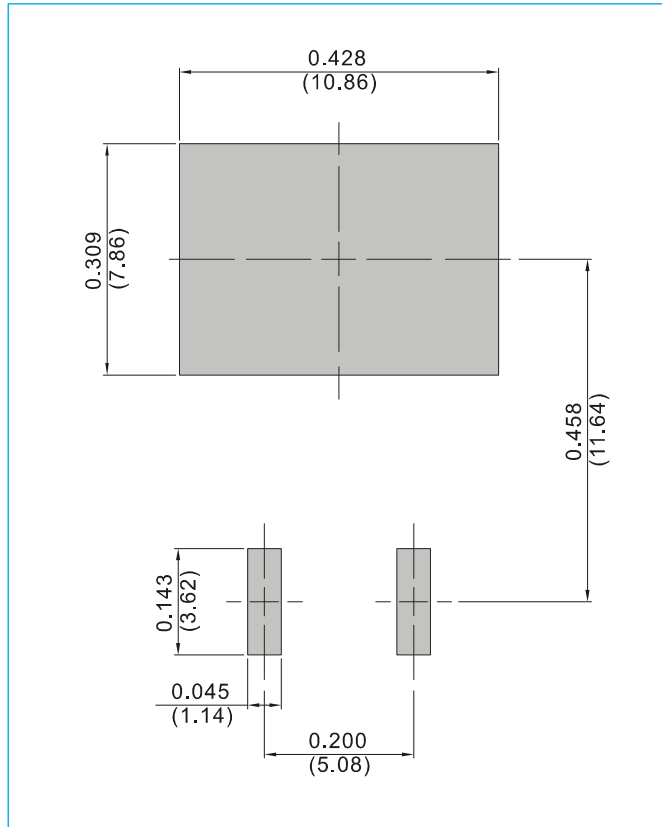

ORDER INFORMATION

- Packing information
T/R - 0.8K per 13" plastic Reel



MBR1040DC~MBR10200DC

Part No_packing code_Version

MBR1040DC_R2_00001

For example :

RB500V-40_R2_00001



Packing Code XX				Version Code XXXXX		
Packing type	1 st Code	Packing size code	2 nd Code	HF or RoHS	1 st Code	2 nd ~5 th Code
Tape and Ammunition Box (T/B)	A	N/A	0	HF	0	serial number
Tape and Reel (T/R)	R	7"	1	RoHS	1	serial number
Bulk Packing (B/P)	B	13"	2			
Tube Packing (T/P)	T	26mm	X			
Tape and Reel (Right Oriented) (TRR)	S	52mm	Y			
Tape and Reel (Left Oriented) (TRL)	L	PANASERT T/B CATHODE UP (PBCU)	U			
FORMING	F	PANASERT T/B CATHODE DOWN (PBCD)	D			