



MBR2040DC SERIES

20 AMPERES SCHOTTKY BARRIER RECTIFIERS

VOLTAGE 40 to 200 Volt **CURRENT** 20 Ampere

TO-263 / D²PAK

Unit : inch(mm)

FEATURES

- Plastic package has Underwriters Laboratory Flammability Classification 94V-O. Flame Retardant Epoxy Molding Compound.
- Low power loss, high efficiency.
- High current capability
- For use in low voltage, high frequency inverters free wheeling, and polarity protection applications.
- Lead free in compliance with EU RoHS 2.0
- Green molding compound as per IEC 61249 standard

MECHANICAL DATA

- Case: TO-263 / D²PAK molded plastic
- Terminals: solder plated, solderable per MIL-STD-750, Method 2026
- Polarity: As marked.
- Weight: 0.049 ounces, 1.38 grams.

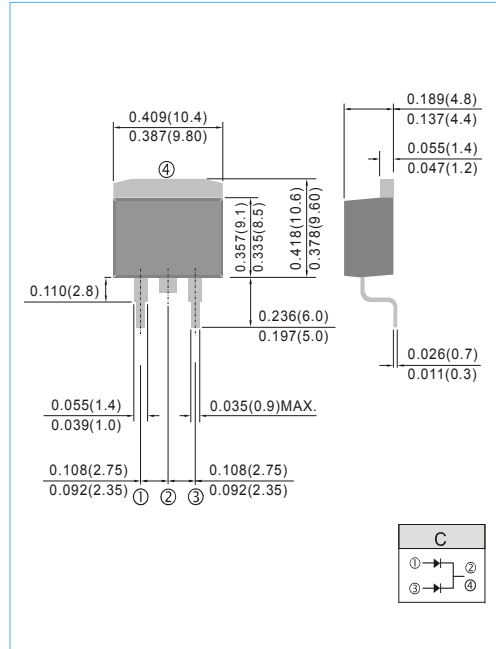

MAXIMUM RATINGS AND ELECTRICAL CHARACTERISTICS

Ratings at 25°C ambient temperature unless otherwise specified. Single phase, half wave, 60 Hz, resistive or inductive load.

For capacitive load, derate current by 20%

PARAMETER	SYMBOL	MBR2040DC	MBR2045DC	MBR2050DC	MBR2060DC	MBR2080DC	MBR2090DC	MBR20100DC	MBR20150DC	MBR20200DC	UNITS	
Maximum Recurrent Peak Reverse Voltage	V_{RRM}	40	45	50	60	80	90	100	150	200	V	
Maximum RMS Voltage	V_{RMS}	28	31.5	35	42	56	63	70	105	140	V	
Maximum DC Blocking Voltage	V_{DC}	40	45	50	60	80	90	100	150	200	V	
Maximum Average Forward Current (See fig.1)	$I_{F(AV)}$	20									A	
Peak Forward Surge Current :8.3ms single half sine-wave superimposed on rated load	I_{FSM}	200									A	
Maximum Forward Voltage at 10A, per leg	V_F	0.7		0.75			0.8		0.9		V	
Maximum DC Reverse Current at Rated DC Blocking Voltage $T_c=25^\circ C$ $T_c=125^\circ C$	I_R						0.05				20	mA
Typical Thermal Resistance	$R_{\theta JC}$						2					$^\circ C / W$
Operating Junction Temperature Range	T_J						-50 to + 150				$^\circ C$	
Storage Temperature Range	T_{STG}						-50 to + 150				$^\circ C$	

Notes :

Both Bonding and Chip structure are available.



MBR2040DC SERIES

RATING AND CHARACTERISTIC CURVES

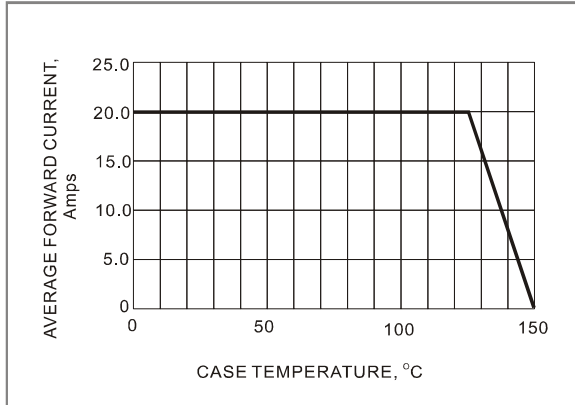

Fig.1- FORWARD CURRENT DERATING CURVE

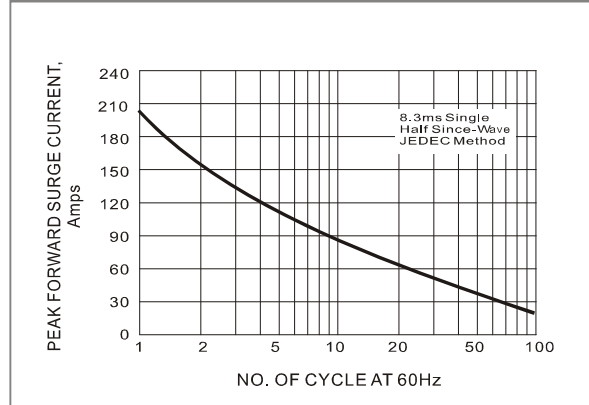

Fig.2- MAXIMUM NON-REPETITIVE SURGE CURRENT

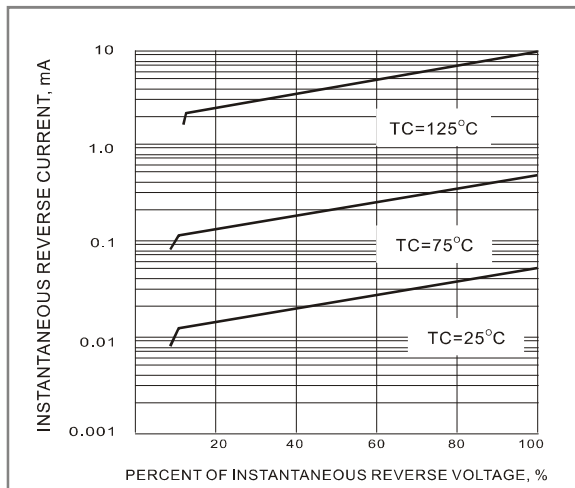

Fig.3- TYPICAL REVERSE CHARACTERISTICS

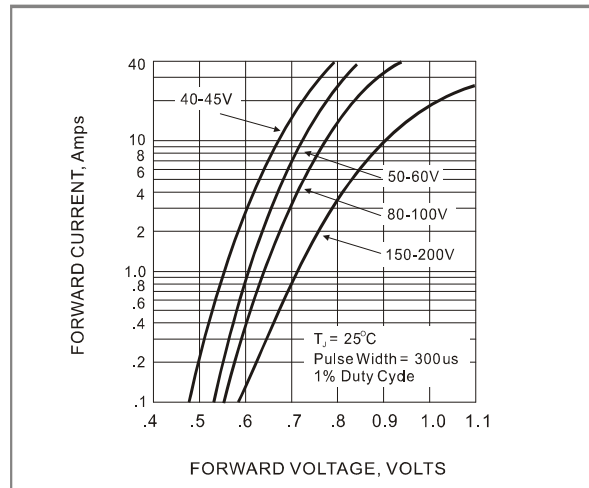

Fig.4- TYPICAL INSTANTANEOUS FORWARD CHARACTERISTICS

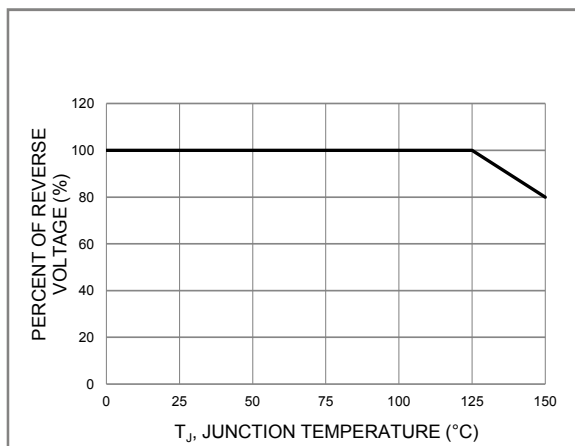
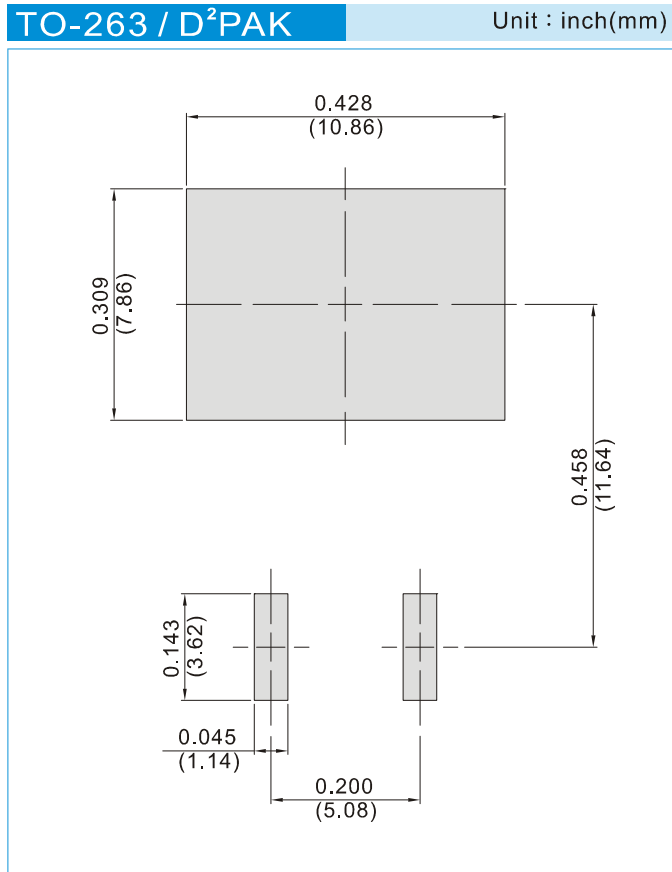

Fig.5- OPERATING TEMPERATURE DERATING CURVE



MBR2040DC SERIES

MOUNTING PAD LAYOUT



ORDER INFORMATION

- Packing information
T/R - 0.8K per 13" plastic Reel



MBR2040DC SERIES

Part No_packing code_Version

MBR2040DC_R2_00001

For example :

RB500V-40_R2_00001



Packing type	Packing Code XX			Version Code XXXXX		
	1 st Code	Packing size code	2 nd Code	HF or RoHS	1 st Code	2 nd ~5 th Code
Tape and Ammunition Box (T/B)	A	N/A	0	HF	0	serial number
Tape and Reel (T/R)	R	7"	1	RoHS	1	serial number
Bulk Packing (B/P)	B	13"	2			
Tube Packing (T/P)	T	26mm	X			
Tape and Reel (Right Oriented) (TRR)	S	52mm	Y			
Tape and Reel (Left Oriented) (TRL)	L	PANASERT T/B CATHODE UP (PBCU)	U			
FORMING	F	PANASERT T/B CATHODE DOWN (PBCD)	D			