

0.8A, 200V - 1000V Standard Bridge Rectifier

FEATURES

- AEC-Q101 qualified available
- Ideal for automated placement
- Reliable low cost construction utilizing molded plastic technique
- High surge current capability
- UL Recognized File # E-326854
- Moisture sensitivity level: level 1, per J-STD-020
- RoHS Compliant
- Halogen-free according to IEC 61249-2-21

APPLICATIONS

- Switching mode power supply (SMPS)
- Adapters
- Lighting application

MECHANICAL DATA

- Case: TO-269AA (MBS)
- Molding compound meets UL 94V-0 flammability rating
- Terminal: Matte tin plated leads, solderable per J-STD-002
- Meet JESD 201 class 2 whisker test
- Polarity: As marked
- Weight: 0.120g (approximately)

KEY PARAMETERS		
PARAMETER	VALUE	UNIT
I_F	0.8	A
V_{RRM}	200 - 1000	V
I_{FSM}	35	A
$T_{J\ MAX}$	150	°C
Package	TO-269AA (MBS)	
Configuration	Quad	

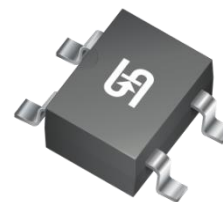

MBS

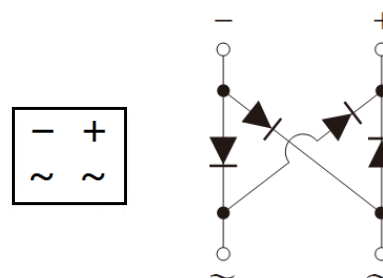

ABSOLUTE MAXIMUM RATINGS ($T_A = 25^\circ\text{C}$ unless otherwise noted)							
PARAMETER	SYMBOL	MBS2	MBS4	MBS6	MBS8	MBS10	UNIT
Marking code on the device		MBS2	MBS4	MBS6	MBS8	MBS10	
Repetitive peak reverse voltage	V_{RRM}	200	400	600	800	1000	V
Reverse voltage, total rms value	$V_{R(RMS)}$	140	280	420	560	700	V
Forward current	On glass-epoxy	I_F	0.5				A
	On aluminum substrate		0.8				A
Surge peak forward current, 8.3ms single half sine-wave superimposed on rated load	I_{FSM}	35				A	
Rating for fusing ($t < 8.3\text{ms}$)	I^2t	5.08				A^2s	
Junction temperature	T_J	- 55 to +150				°C	
Storage temperature	T_{STG}	- 55 to +150				°C	

THERMAL PERFORMANCE			
PARAMETER	SYMBOL	TYP	UNIT
Junction-to-lead thermal resistance ⁽¹⁾	$R_{\theta JL}$	20	°C/W
Junction-to-ambient thermal resistance ⁽²⁾	$R_{\theta JA}$	70	°C/W
Junction-to-ambient thermal resistance ⁽¹⁾	$R_{\theta JA}$	85	°C/W

Notes:

1. On glass epoxy P.C.B. mounted on 0.05" x 0.05" (1.3mm x 1.3mm) pads
2. On aluminum substrate P.C.B. with an area of 0.8" x 0.8" (20mm x 20mm) mounted on 0.05" x 0.05" (1.3mm x 1.3mm) solder pads

ELECTRICAL SPECIFICATIONS ($T_A = 25^\circ\text{C}$ unless otherwise noted)					
PARAMETER	CONDITIONS	SYMBOL	TYP	MAX	UNIT
Forward voltage per diode ⁽¹⁾	$I_F = 0.4\text{A}, T_J = 25^\circ\text{C}$	V_F	-	1	V
Reverse current @ rated V_R per diode ⁽²⁾	$T_J = 25^\circ\text{C}$	I_R	-	5	μA
	$T_J = 125^\circ\text{C}$		-	100	μA
Junction capacitance per diode	1MHz, $V_R = 4.0\text{V}$	C_J	13	-	pF

Notes:

1. Pulse test with PW = 0.3ms
2. Pulse test with PW = 30ms

ORDERING INFORMATION		
ORDERING CODE ⁽¹⁾⁽²⁾	PACKAGE	PACKING
MBSx	TO-269AA (MBS)	3,000 / Tape & Reel
MBSxH	TO-269AA (MBS)	3,000 / Tape & Reel

Notes:

1. "x" defines voltage from 200V(MBS2) to 1000V(MBS10)
2. "H" means AEC-Q101 qualified

CHARACTERISTICS CURVES

($T_A = 25^\circ\text{C}$ unless otherwise noted)

Fig.1 Forward Current Derating Curve

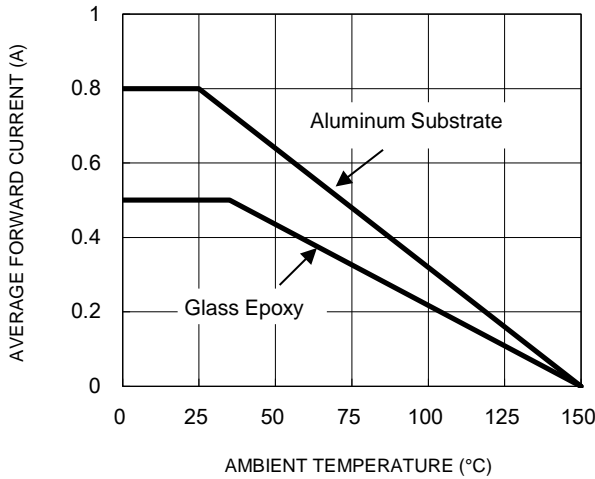

Fig.2 Typical Junction Capacitance

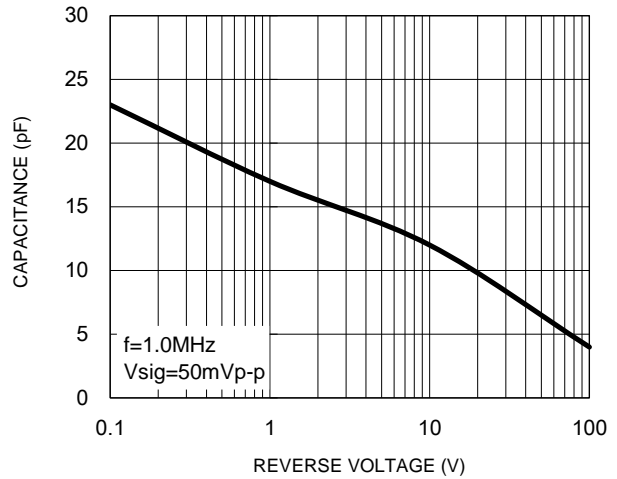

Fig.3 Typical Reverse Characteristics

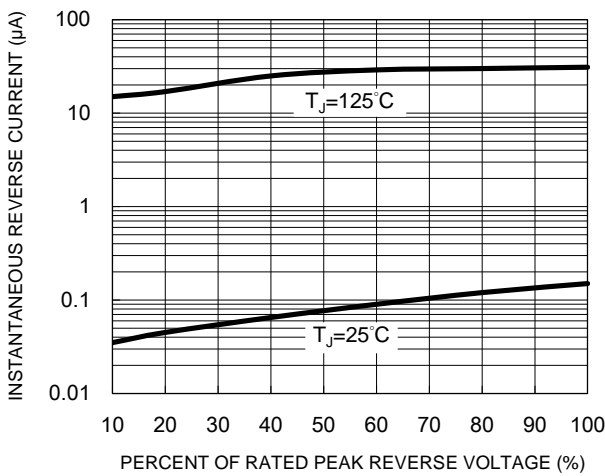

Fig.4 Typical Forward Characteristics

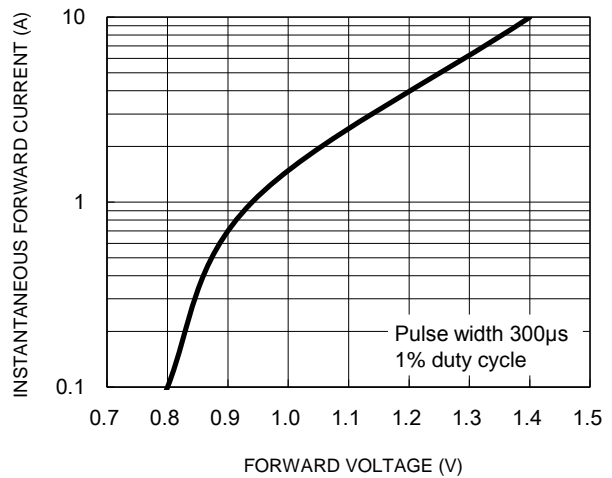
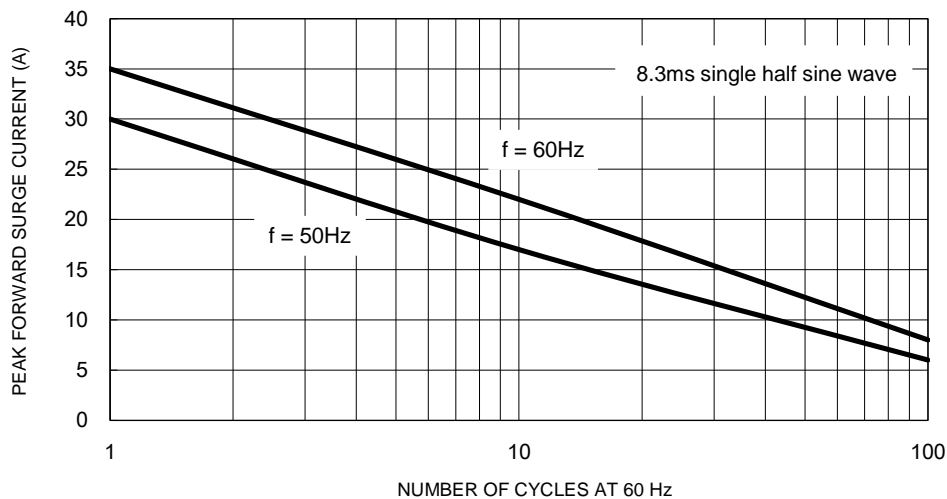
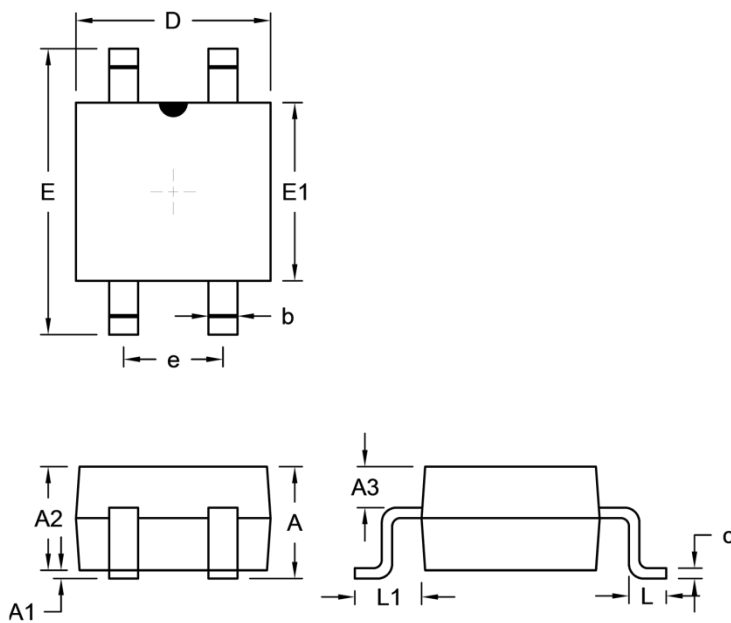

Fig.5 Maximum Non-Repetitive Forward Surge Current



PACKAGE OUTLINE DIMENSIONS

TO-269AA (MBS)



DIM.	Unit (mm)		Unit (inch)	
	Min.	Max.	Min.	Max.
A	-	2.90	-	0.114
A1	-	0.20	-	0.008
A2	2.30	2.70	0.091	0.106
A3	0.95	1.53	0.037	0.060
b	0.56	0.84	0.022	0.033
c	0.15	0.35	0.006	0.014
D	4.50	4.90	0.177	0.193
E	-	6.90	-	0.272
E1	3.60	5.00	0.142	0.197
e	2.20	2.60	0.087	0.102
L	0.70	1.10	0.028	0.043
L1	1.10	2.12	0.043	0.083

SUGGESTED PAD LAYOUT

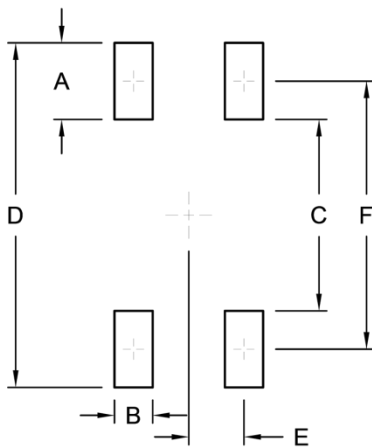

Symbol	Unit (mm)	Unit (inch)
A	1.80	0.071
B	0.90	0.035
C	4.50	0.177
D	8.10	0.319
E	1.30	0.051
F	6.30	0.248

MARKING DIAGRAM



P/N = Marking Code
 YW = Date Code
 F = Factory Code