

ON Semiconductor

Is Now

onsemi™

To learn more about onsemi™, please visit our website at
www.onsemi.com

onsemi and **onsemi** and other names, marks, and brands are registered and/or common law trademarks of Semiconductor Components Industries, LLC dba "**onsemi**" or its affiliates and/or subsidiaries in the United States and/or other countries. **onsemi** owns the rights to a number of patents, trademarks, copyrights, trade secrets, and other intellectual property. A listing of **onsemi** product/patent coverage may be accessed at www.onsemi.com/site/pdf/Patent-Marking.pdf. **onsemi** reserves the right to make changes at any time to any products or information herein, without notice. The information herein is provided "as-is" and **onsemi** makes no warranty, representation or guarantee regarding the accuracy of the information, product features, availability, functionality, or suitability of its products for any particular purpose, nor does **onsemi** assume any liability arising out of the application or use of any product or circuit, and specifically disclaims any and all liability, including without limitation special, consequential or incidental damages. Buyer is responsible for its products and applications using **onsemi** products, including compliance with all laws, regulations and safety requirements or standards, regardless of any support or applications information provided by **onsemi**. "Typical" parameters which may be provided in **onsemi** data sheets and/or specifications can and do vary in different applications and actual performance may vary over time. All operating parameters, including "Typicals" must be validated for each customer application by customer's technical experts. **onsemi** does not convey any license under any of its intellectual property rights nor the rights of others. **onsemi** products are not designed, intended, or authorized for use as a critical component in life support systems or any FDA Class 3 medical devices or medical devices with a same or similar classification in a foreign jurisdiction or any devices intended for implantation in the human body. Should Buyer purchase or use **onsemi** products for any such unintended or unauthorized application, Buyer shall indemnify and hold **onsemi** and its officers, employees, subsidiaries, affiliates, and distributors harmless against all claims, costs, damages, and expenses, and reasonable attorney fees arising out of, directly or indirectly, any claim of personal injury or death associated with such unintended or unauthorized use, even if such claim alleges that **onsemi** was negligent regarding the design or manufacture of the part. **onsemi** is an Equal Opportunity/Affirmative Action Employer. This literature is subject to all applicable copyright laws and is not for resale in any manner. Other names and brands may be claimed as the property of others.

MC74AC652, MC74ACT652

Octal Transceiver/Register with 3-State Outputs (Non-Inverting)

The MC74AC/ACT652 consists of registered bus transceiver circuits, with outputs, D-type flip-flops and control circuitry providing multiplexed transmission of data directly from the input bus or from the internal storage registers. Data on the A or B bus will be loaded into the respective registers on the LOW-to-HIGH transition of the appropriate clock pin (CAB or CBA). The four fundamental data handling functions available are illustrated in Figures 1 to 4.

Features

- Independent Registers for A and B Buses
- Multiplexed Real-Time and Stored Data Transfers
- Choice of True and Inverting Data Paths
- 3-State Outputs
- 300 mil Slim Dual-in-Line Package
- Outputs Source/Sink 24 mA
- 'ACT652 Has TTL Compatible Inputs
- These are Pb-Free Devices

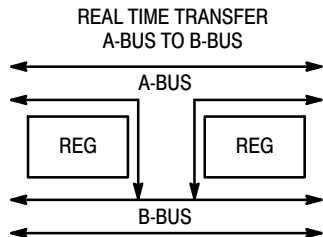

Figure 1.

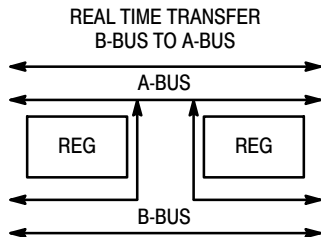

Figure 2.

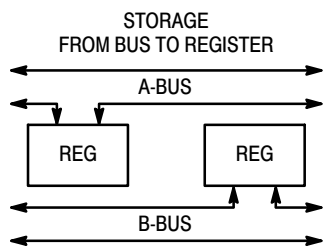

Figure 3.

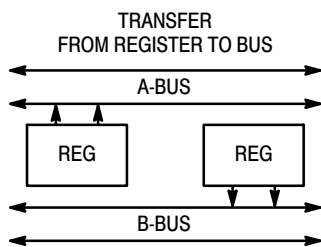

Figure 4.



ON Semiconductor™

www.onsemi.com

MARKING DIAGRAMS

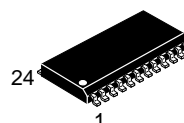

SO-24
DW SUFFIX
CASE 751E

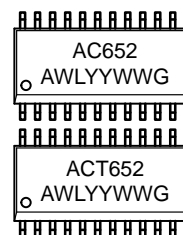

A = Assembly Location
WL = Wafer Lot
YY = Year
WW = Work Week
G = Pb-Free Package

ORDERING INFORMATION

See detailed ordering and shipping information in the package dimensions section on page 9 of this data sheet.

MC74AC652, MC74ACT652

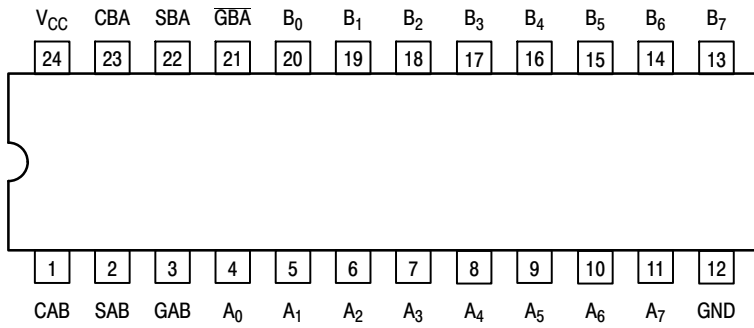

PIN ASSIGNMENT

PIN	FUNCTION
A ₀ –A ₇	Data Register A Inputs Data Register A Outputs
B ₀ –B ₇	Data Register B Inputs Data Register B Outputs
CAB, CBA	Clock Pulse Inputs
SAB, SBA	Transmit/Receive Inputs
GAB, \overline{GAB}	Output Enable Inputs

Figure 5. Pinout: 24-Lead Plastic Package
(Top View)

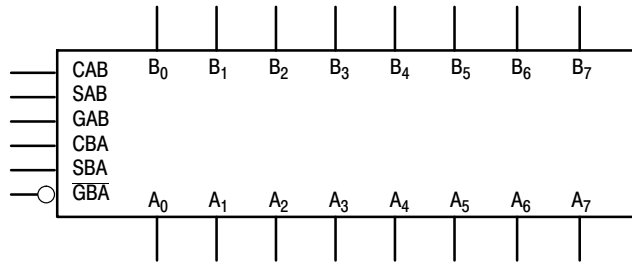
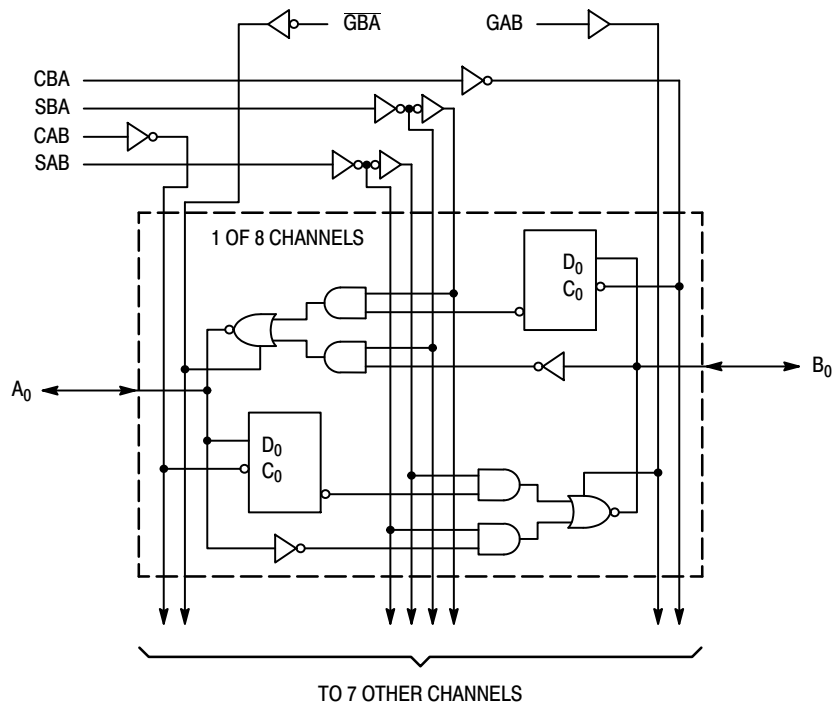

Figure 6. Logic Symbol



NOTE: This diagram is provided only for the understanding of logic operations and should not be used to estimate propagation delays.

Figure 7. Logic Diagram

MC74AC652, MC74ACT652

FUNCTION TABLE

Inputs						Data I/O*		Operation or Function
GAB	$\overline{\text{GBA}}$	CAB	CBA	SAB	SBA	A ₀ – A ₇	B ₀ – B ₇	
L L	H H	H or L ↑	H or L ↑	X X	X X	Input	Input	Isolation Store A and B Data
X H	H H	↑ ↑	H or L ↑	X X**	X X	Input Input	Unspecified* Output	Store A, Hold B Store A in Both Registers
L L	X L	H or L ↑	↑ ↑	X X	X X**	Unspecified* Output	Input Input	Hold A, Store B Store B in Both Registers
L L	L L	X X	X H or L	X X	L H	Output	Input	Real-Time B Data to A Bus Stored B Data to A Bus
H H	H H	X H or L	X X	L H	X X	Input	Output	Real-Time A Data to B Bus Stored A Data to B Bus
H	L	H or L	H or L	H	H	Output	Output	Stored A Data to B Bus and Stored B Data to A Bus

*The data output functions may be enabled or disabled by various signals at the $\overline{\text{GBA}}$ and GAB inputs. Data input functions are always enabled; i.e., data at the bus pins will be stored on every LOW-to-HIGH transition of the appropriate clock inputs.

**Select control = L: clocks can occur simultaneously.

H = HIGH Voltage Level; L = LOW Voltage Level; X = Immaterial; ↑ = LOW-to-HIGH Transition

MC74AC652, MC74ACT652

MAXIMUM RATINGS

Symbol	Parameter	Value	Unit	
V _{CC}	DC Supply Voltage (Referenced to GND)	-0.5 to +7.0	V	
V _{IN}	DC Input Voltage (Referenced to GND)	-0.5 to V _{CC} +0.5	V	
V _{OUT}	DC Output Voltage (Referenced to GND) (Note 1)	-0.5 to V _{CC} +0.5	V	
I _{IK}	DC Input Diode Current	±20	mA	
I _{OK}	DC Output Diode Current	±50	mA	
I _{OUT}	DC Output Sink/Source Current	±50	mA	
I _{CC}	DC Supply Current, per Output Pin	±50	mA	
I _{GND}	DC Ground Current, per Output Pin	±100	mA	
T _{STG}	Storage Temperature Range	-65 to +150	°C	
T _L	Lead temperature, 1 mm from Case for 10 Seconds	260	°C	
T _J	Junction Temperature Under Bias	140	°C	
θ _{JA}	Thermal Resistance (Note 2)	59.8	°C/W	
MSL	Moisture Sensitivity	Level 1		
F _R	Flammability Rating	Oxygen Index: 30% – 35% UL 94 V-0 @ 0.125 in		
V _{ESD}	ESD Withstand Voltage	Human Body Model (Note 3) Machine Model (Note 4) Charged Device Model (Note 5)	> 2000 > 200 > 1000	V
I _{Latchup}	Latchup Performance	Above V _{CC} and Below GND at 85°C (Note 6)	±100	mA

Stresses exceeding those listed in the Maximum Ratings table may damage the device. If any of these limits are exceeded, device functionality should not be assumed, damage may occur and reliability may be affected.

1. I_{OUT} absolute maximum rating must be observed.
2. The package thermal impedance is calculated in accordance with JESD 51-7.
3. Tested to EIA/JESD22-A114-A.
4. Tested to EIA/JESD22-A115-A.
5. Tested to JESD22-C101-A.
6. Tested to EIA/JESD78.

RECOMMENDED OPERATING CONDITIONS

Symbol	Parameter	Min	Typ	Max	Unit	
V _{CC}	Supply Voltage	'AC	2.0	5.0	6.0	V
		'ACT	4.5	5.0	5.5	
V _{in} , V _{out}	DC Input Voltage, Output Voltage (Ref. to GND)	0	–	V _{CC}	V	
t _r , t _f	Input Rise and Fall Time (Note 1) 'AC Devices except Schmitt Inputs	V _{CC} @ 3.0 V	–	150	–	ns/V
		V _{CC} @ 4.5 V	–	40	–	
		V _{CC} @ 5.5 V	–	25	–	
t _r , t _f	Input Rise and Fall Time (Note 2) 'ACT Devices except Schmitt Inputs	V _{CC} @ 4.5 V	–	10	–	ns/V
		V _{CC} @ 5.5 V	–	8.0	–	
T _A	Operating Ambient Temperature Range	-40	25	85	°C	
I _{OH}	Output Current — HIGH	–	–	-24	mA	
I _{OL}	Output Current — LOW	–	–	24	mA	

Functional operation above the stresses listed in the Recommended Operating Ranges is not implied. Extended exposure to stresses beyond the Recommended Operating Ranges limits may affect device reliability.

1. V_{in} from 30% to 70% V_{CC}; see individual Data Sheets for devices that differ from the typical input rise and fall times.
2. V_{in} from 0.8 V to 2.0 V; see individual Data Sheets for devices that differ from the typical input rise and fall times.

MC74AC652, MC74ACT652

DC CHARACTERISTICS

Symbol	Parameter	V _{CC} (V)	74AC		74AC	Unit	Conditions
			T _A = +25°C		T _A = -40°C to +85°C		
			Typ	Guaranteed Limits			
V _{IH}	Minimum High Level Input Voltage	3.0	1.5	2.1	2.1	V	V _{OUT} = 0.1 V or V _{CC} - 0.1 V
		4.5	2.25	3.15	3.15		
		5.5	2.75	3.85	3.85		
V _{IL}	Maximum Low Level Input Voltage	3.0	1.5	0.9	0.9	V	V _{OUT} = 0.1 V or V _{CC} - 0.1 V
		4.5	2.25	1.35	1.35		
		5.5	2.75	1.65	1.65		
V _{OH}	Minimum High Level Output Voltage	3.0	2.99	2.9	2.9	V	I _{OUT} = - 50 μA
		4.5	4.49	4.4	4.4		
		5.5	5.49	5.4	5.4		
		3.0	-	2.56	2.46	V	*V _{IN} = V _{IL} or V _{IH} - 12 mA I _{OH} - 24 mA - 24 mA
		4.5	-	3.86	3.76		
		5.5	-	4.86	4.76		
V _{OL}	Minimum Low Level Output Voltage	3.0	0.002	0.1	0.1	V	I _{OUT} = 50 μA
		4.5	0.001	0.1	0.1		
		5.5	0.001	0.1	0.1		
		3.0	-	0.36	0.44	V	*V _{IN} = V _{IL} or V _{IH} 12 mA I _{OL} 24 mA 24 mA
		4.5	-	0.36	0.44		
		5.5	-	0.36	0.44		
I _{IN}	Maximum Input Leakage Current	5.5	-	±0.1	±1.0	μA	V _I = V _{CC} , GND
I _{OZT}	Maximum 3-State Current	5.5	-	±0.6	±6.0	μA	V _I (OE) = V _{IL} , V _{IH} V _I = V _{CC} , GND V _O = V _{CC} , GND
I _{OLD}	†Minimum Dynamic Output Current	5.5	-	-	75	mA	V _{OLD} = 1.65 V Max
I _{OHD}		5.5	-	-	-75	mA	V _{OHD} = 3.85 V Min
I _{CC}	Maximum Quiescent Supply Current	5.5	-	8.0	80	μA	V _{IN} = V _{CC} or GND

*All outputs loaded; thresholds on input associated with output under test.

†Maximum test duration 2.0 ms, one input loaded at a time.

NOTE: I_{IN} and I_{CC} @ 3.0 V are guaranteed to be less than or equal to the respective limit @ 5.5 V.

MC74AC652, MC74ACT652

AC CHARACTERISTICS

Symbol	Parameter	V _{CC} * (V)	74AC		74AC		Unit
			T _A = +25°C C _L = 50 pF		T _A = -40°C to +85°C C _L = 50 pF		
			Min	Max	Min	Max	
t _{PLH}	Propagation Delay CPBA or CPAB to A _n or B _n	3.0	4.0	17.0	3.0	19.0	ns
		5.0	2.5	12.0	2.0	14.0	
t _{PHL}	Propagation Delay CPBA or CPAB to A _n or B _n	3.0	3.0	14.5	2.5	16.5	ns
		5.0	2.0	10.5	1.5	12.0	
t _{PLH}	Propagation Delay A or B to B _n or A _n	3.0	3.0	14.0	2.5	16.0	ns
		5.0	2.0	9.5	1.5	11.0	
t _{PHL}	Propagation Delay A or B to B _n or A _n	3.0	2.5	13.0	2.0	15.0	ns
		5.0	1.5	9.0	1.0	10.5	
t _{PLH}	Propagation Delay SBA or SAB to A _n or B _n	3.0	3.0	14.0	2.5	16.0	ns
		5.0	2.5	10.0	2.0	11.5	
t _{PHL}	Propagation Delay SBA or SAB to A _n or B _n	3.0	2.5	13.5	2.0	15.5	ns
		5.0	2.0	10.0	1.5	11.5	
t _{PZH}	Output Enable Time \overline{OEBA} to A _n	3.0	2.5	12.0	2.0	13.5	ns
		5.0	1.5	9.0	1.0	10.0	
t _{PZL}	Output Enable Time \overline{OEBA} to A _n	3.0	2.5	12.0	2.0	14.0	ns
		5.0	1.5	9.0	1.0	10.5	
t _{PHZ}	Output Disable Time \overline{OEBA} to A _n	3.0	3.0	13.0	2.5	14.0	ns
		5.0	2.0	11.0	1.5	12.0	
t _{PLZ}	Output Disable Time \overline{OEBA} to A _n	3.0	2.5	12.5	2.0	14.0	ns
		5.0	2.0	10.5	1.5	12.0	

*Voltage Range 3.3 V is 3.3 V ±0.3 V.
Voltage Range 5.0 V is 5.0 V ±0.5 V.

MC74AC652, MC74ACT652

DC CHARACTERISTICS

Symbol	Parameter	V _{CC} (V)	74ACT		74ACT	Unit	Conditions
			T _A = +25°C		T _A = -40°C to +85°C		
			Typ	Guaranteed Limits			
V _{IH}	Minimum High Level Input Voltage	4.5	1.5	2.0	2.0	V	V _{OUT} = 0.1 V or V _{CC} - 0.1 V
		5.5	1.5	2.0	2.0		
V _{IL}	Maximum Low Level Input Voltage	4.5	1.5	0.8	0.8	V	V _{OUT} = 0.1 V or V _{CC} - 0.1 V
		5.5	1.5	0.8	0.8		
V _{OH}	Minimum High Level Output Voltage	4.5	4.49	4.4	4.4	V	I _{OUT} = - 50 μA
		5.5	5.49	5.4	5.4		
		4.5	-	3.86	3.76	V	*V _{IN} = V _{IL} or V _{IH} - 24 mA
		5.5	-	4.86	4.76		
V _{OL}	Minimum Low Level Output Voltage	4.5	0.001	0.1	0.1	V	I _{OUT} = - 50 μA
		5.5	0.001	0.1	0.1		
		4.5	-	0.36	0.44	V	*V _{IN} = V _{IL} or V _{IH} - 24 mA
		5.5	-	0.36	0.44		
I _{IN}	Maximum Input Leakage Current	5.5	-	±0.1	±1.0	μA	V _I = V _{CC} , GND
ΔI _{CCT}	Additional Max. I _{CC} /Input	5.5	0.6	-	1.5	mA	V _I = V _{CC} - 2.1 V
I _{OZT}	Maximum 3-State Current	5.5	-	±0.6	±6.0	μA	V _I (OE) = V _{IL} , V _{IH} V _I = V _{CC} , GND V _O = V _{CC} , GND
I _{OLD}	†Minimum Dynamic Output Current	5.5	-	-	75	mA	V _{OLD} = 1.65 V Max
I _{OHD}		5.5	-	-	-75	mA	V _{OHD} = 3.85 V Min
I _{CC}	Maximum Quiescent Supply Current	5.5	-	8.0	80	μA	V _{IN} = V _{CC} or GND

*All outputs loaded; thresholds on input associated with output under test.

†Maximum test duration 2.0 ms, one input loaded at a time.

MC74AC652, MC74ACT652

AC CHARACTERISTICS

Symbol	Parameter	V _{CC} * (V)	74ACT		74ACT		Unit
			T _A = +25°C C _L = 50 pF		T _A = -40°C to +85°C C _L = 50 pF		
			Min	Max	Min	Max	
t _{PLH}	Propagation Delay CPBA or CPAB to A _n or B _n	5.0	4.0	14.5	3.5	16.5	ns
t _{PHL}	Propagation Delay CPBA or CPAB to A _n or B _n	5.0	3.5	14.5	3.0	16.5	ns
t _{PLH}	Propagation Delay A or B to B _n or A _n	5.0	2.5	11.5	2.0	13.0	ns
t _{PHL}	Propagation Delay A or B to B _n or A _n	5.0	2.5	11.5	2.0	13.0	ns
t _{PLH}	Propagation Delay SBA or SAB to A _n or B _n	5.0	2.5	12.0	2.0	13.5	ns
t _{PHL}	Propagation Delay SBA or SAB to A _n or B _n	5.0	3.0	12.0	2.5	13.5	ns
t _{PZH}	Output Enable Time OEBA to A _n	5.0	2.0	11.5	1.5	13.0	ns
t _{PZL}	Output Enable Time OEBA to A _n	5.0	2.5	11.5	2.0	13.0	ns
t _{PHZ}	Output Disable Time OEBA to A _n	5.0	3.0	13.0	2.5	14.0	ns
t _{PLZ}	Output Disable Time OEBA to A _n	5.0	2.5	12.5	2.0	14.0	ns
t _{PZH}	Output Enable time OEAB to B _n	5.0	2.5	12.0	2.0	13.5	ns
t _{PZL}	Output Enable Time OEAB to B _n	5.0	2.5	12.0	2.0	13.5	ns
t _{PHZ}	Output Enable Time OEAB to B _n	5.0	3.5	13.5	3.0	14.5	ns
t _{PLZ}	Output Enable Time OEAB to B _n	5.0	3.0	13.5	2.5	15.0	ns
t _s	Setup Time, HIGH or LOW A _n or B _n to CPBA or CPAB	5.0	7.0	–	8.0	–	ns
t _h	Hold Time, HIGH or LOW A _n or B _n to CPBA or CPAB	5.0	2.5	–	2.5	–	ns
t _w	CPAB, CPBA Pulse Width HIGH or LOW	5.0	6.0	–	7.0	–	ns

*Voltage Range 3.3 V is 3.3 V ±0.3 V.
Voltage Range 5.0 V is 5.0 V ±0.5 V.

CAPACITANCE

Symbol	Parameter	74ACT Typ	Unit	Test Conditions
C _{IN}	Input Capacitance	4.5	pF	V _{CC} = 5.0 V
C _{I/O}	Input/Output Capacitance	15	pF	V _{CC} = 5.0 V
C _{PD}	Power Dissipation Capacitance	60.0	pF	V _{CC} = 5.0 V

MC74AC652, MC74ACT652

ORDERING INFORMATION

Device	Package	Shipping†
MC74AC652DWG	SOIC-24 (Pb-Free)	30 Units / Rail
MC74AC652DWR2G		1000 / Tape & Reel
MC74ACT652DWG		30 Units / Rail
MC74ACT652DWR2G		1000 / Tape & Reel

†For information on tape and reel specifications, including part orientation and tape sizes, please refer to our Tape and Reel Packaging Specifications Brochure, BRD8011/D.