

# MC74AC373, MC74ACT373

## Octal Transparent Latch with 3-State Outputs

The MC74AC373/74ACT373 consists of eight latches with 3-state outputs for bus organized system applications. The flip-flops appear transparent to the data when Latch Enable (LE) is HIGH. When LE is LOW, the data that meets the setup time is latched. Data appears on the bus when the Output Enable ( $\overline{OE}$ ) is LOW. When  $\overline{OE}$  is HIGH, the bus output is in the high impedance state.

### Features

- Eight Latches in a Single Package
- 3-State Outputs for Bus Interfacing
- Outputs Source/Sink 24 mA
- 'ACT373 Has TTL Compatible Inputs
- These are Pb-Free Devices

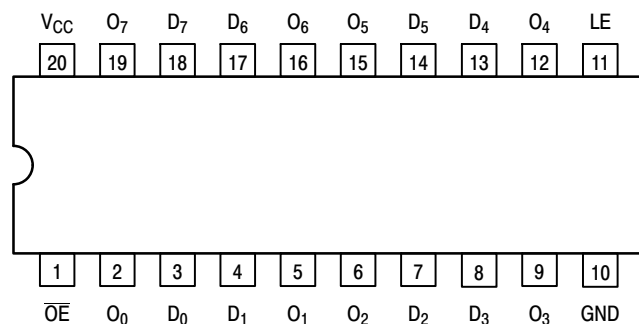

Figure 1. Pinout: 20-Lead Packages Conductors  
(Top View)

### PIN ASSIGNMENT

PIN	FUNCTION
D <sub>0</sub> –D <sub>7</sub>	Data Inputs
LE	Latch Enable Input
$\overline{OE}$	Output Enable Input
O <sub>0</sub> –O <sub>7</sub>	3-State Latch Outputs

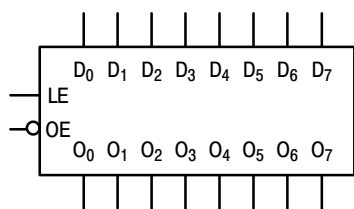
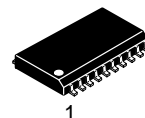

Figure 2. Logic Symbol



ON Semiconductor®

[www.onsemi.com](http://www.onsemi.com)



SOIC-20W  
DW SUFFIX  
CASE 751D

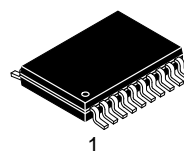

TSSOP-20  
DT SUFFIX  
CASE 948E

### ORDERING INFORMATION

See detailed ordering and shipping information in the package dimensions section on page 8 of this data sheet.

### DEVICE MARKING INFORMATION

See general marking information in the device marking section on page 9 of this data sheet.

# MC74AC373, MC74ACT373

## TRUTH TABLE

Inputs			Outputs
$\overline{OE}$	LE	$D_n$	$O_n$
H	X	X	Z
L	H	L	L
L	H	H	H
L	L	X	$O_0$

H = HIGH Voltage Level

L = LOW Voltage Level

Z = High Impedance

X = Immaterial

$O_0$  = Previous  $O_0$  before LOW-to-HIGH Transition of Clock

## FUNCTIONAL DESCRIPTION

The MC74AC373/74ACT373 contains eight D-type latches with 3-state standard outputs. When the Latch Enable (LE) input is HIGH, data on the  $D_n$  inputs enters the latches. In this condition the latches are transparent, i.e., a latch output will change state each time its D input changes. When LE is LOW, the latches store the information that was present on the D inputs a setup time preceding the HIGH-to-LOW transition of LE. The 3-state standard outputs are controlled by the Output Enable ( $\overline{OE}$ ) input. When  $\overline{OE}$  is LOW, the standard outputs are in the 2-state mode. When  $\overline{OE}$  is HIGH, the standard outputs are in the high impedance mode but this does not interfere with entering new data into the latches.

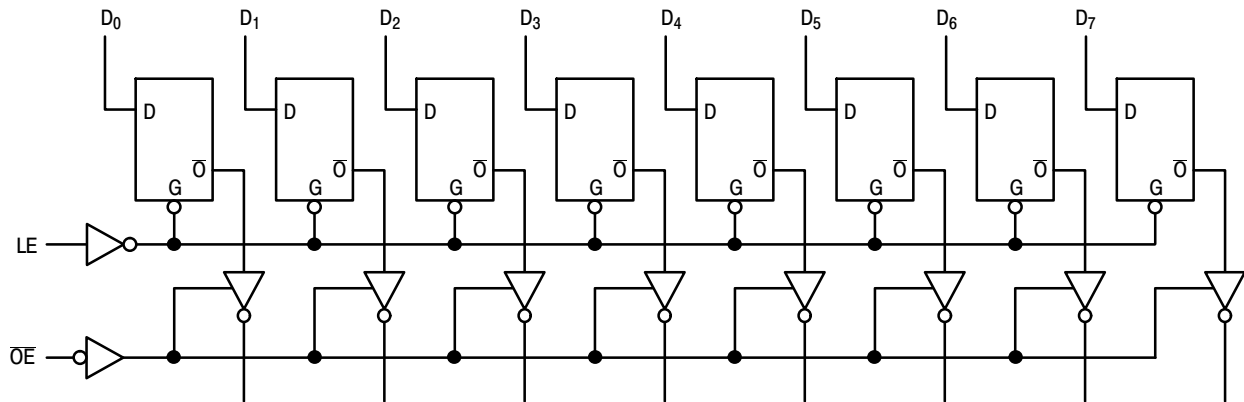

NOTE: This diagram is provided only for the understanding of logic operations and should not be used to estimate propagation delays.

Figure 3. Logic Diagram

# MC74AC373, MC74ACT373

## MAXIMUM RATINGS

Symbol	Parameter	Value	Unit
V <sub>CC</sub>	DC Supply Voltage (Referenced to GND)	-0.5 to +7.0	V
V <sub>IN</sub>	DC Input Voltage (Referenced to GND)	-0.5 to V <sub>CC</sub> +0.5	V
V <sub>OUT</sub>	DC Output Voltage (Referenced to GND) (Note 1)	-0.5 to V <sub>CC</sub> +0.5	V
I <sub>IK</sub>	DC Input Diode Current	±20	mA
I <sub>OK</sub>	DC Output Diode Current	±50	mA
I <sub>OUT</sub>	DC Output Sink/Source Current	±50	mA
I <sub>CC</sub>	DC Supply Current, per Output Pin	±50	mA
I <sub>GND</sub>	DC Ground Current, per Output Pin	±100	mA
T <sub>STG</sub>	Storage Temperature Range	-65 to +150	°C
T <sub>L</sub>	Lead temperature, 1 mm from Case for 10 Seconds	260	°C
T <sub>J</sub>	Junction Temperature Under Bias	140	°C
θ <sub>JA</sub>	Thermal Resistance (Note 2)	SOIC TSSOP 65.8 110.7	°C/W
MSL	Moisture Sensitivity	SOIC TSSOP Level 3 Level 1	
F <sub>R</sub>	Flammability Rating	Oxygen Index: 30% – 35%	UL 94 V-0 @ 0.125 in
V <sub>ESD</sub>	ESD Withstand Voltage	Human Body Model (Note 3) Machine Model (Note 4) Charged Device Model (Note 5)	> 2000 > 200 > 1000 V
I <sub>Latchup</sub>	Latchup Performance	Above V <sub>CC</sub> and Below GND at 85°C (Note 6)	±100 mA

Stresses exceeding those listed in the Maximum Ratings table may damage the device. If any of these limits are exceeded, device functionality should not be assumed, damage may occur and reliability may be affected.

1. I<sub>OUT</sub> absolute maximum rating must be observed.
2. The package thermal impedance is calculated in accordance with JESD 51-7.
3. Tested to EIA/JESD22-A114-A.
4. Tested to EIA/JESD22-A115-A.
5. Tested to JESD22-C101-A.
6. Tested to EIA/JESD78.

## RECOMMENDED OPERATING CONDITIONS

Symbol	Parameter	Min	Typ	Max	Unit	
V <sub>CC</sub>	Supply Voltage	'AC	2.0	5.0	6.0	V
		'ACT	4.5	5.0	5.5	
V <sub>IN</sub> , V <sub>OUT</sub>	DC Input Voltage, Output Voltage (Ref. to GND)	0	-	V <sub>CC</sub>	V	
t <sub>r</sub> , t <sub>f</sub>	Input Rise and Fall Time (Note 7) 'AC Devices except Schmitt Inputs	V <sub>CC</sub> @ 3.0 V	-	150	-	ns/V
		V <sub>CC</sub> @ 4.5 V	-	40	-	
		V <sub>CC</sub> @ 5.5 V	-	25	-	
t <sub>r</sub> , t <sub>f</sub>	Input Rise and Fall Time (Note 8) 'ACT Devices except Schmitt Inputs	V <sub>CC</sub> @ 4.5 V	-	10	-	ns/V
		V <sub>CC</sub> @ 5.5 V	-	8.0	-	
T <sub>A</sub>	Operating Ambient Temperature Range	-40	25	85	°C	
I <sub>OH</sub>	Output Current – High	-	-	-24	mA	
I <sub>OL</sub>	Output Current – Low	-	-	24	mA	

Functional operation above the stresses listed in the Recommended Operating Ranges is not implied. Extended exposure to stresses beyond the Recommended Operating Ranges limits may affect device reliability.

7. V<sub>IN</sub> from 30% to 70% V<sub>CC</sub>; see individual Data Sheets for devices that differ from the typical input rise and fall times.
8. V<sub>IN</sub> from 0.8 V to 2.0 V; see individual Data Sheets for devices that differ from the typical input rise and fall times.

# MC74AC373, MC74ACT373

## DC CHARACTERISTICS

Symbol	Parameter	V <sub>CC</sub> (V)	74AC		74AC		Unit	Conditions
			T <sub>A</sub> = +25°C		T <sub>A</sub> = -40°C to +85°C			
			Typ	Guaranteed Limits				
V <sub>IH</sub>	Minimum High Level Input Voltage	3.0	1.5	2.1	2.1		V	V <sub>OUT</sub> = 0.1 V or V <sub>CC</sub> - 0.1 V
		4.5	2.25	3.15	3.15			
		5.5	2.75	3.85	3.85			
V <sub>IL</sub>	Maximum Low Level Input Voltage	3.0	1.5	0.9	0.9		V	V <sub>OUT</sub> = 0.1 V or V <sub>CC</sub> - 0.1 V
		4.5	2.25	1.35	1.35			
		5.5	2.75	1.65	1.65			
V <sub>OH</sub>	Minimum High Level Output Voltage	3.0	2.99	2.9	2.9		V	I <sub>OUT</sub> = -50 μA
		4.5	4.49	4.4	4.4			
		5.5	5.49	5.4	5.4			
		3.0	-	2.56	2.46		V	*V <sub>IN</sub> = V <sub>IL</sub> or V <sub>IH</sub> -12 mA I <sub>OH</sub> -24 mA -24 mA
		4.5	-	3.86	3.76			
		5.5	-	4.86	4.76			
V <sub>OL</sub>	Maximum Low Level Output Voltage	3.0	0.002	0.1	0.1		V	I <sub>OUT</sub> = 50 μA
		4.5	0.001	0.1	0.1			
		5.5	0.001	0.1	0.1			
		3.0	-	0.36	0.44		V	*V <sub>IN</sub> = V <sub>IL</sub> or V <sub>IH</sub> 12 mA I <sub>OL</sub> 24 mA 24 mA
		4.5	-	0.36	0.44			
		5.5	-	0.36	0.44			
I <sub>IN</sub>	Maximum Input Leakage Current	5.5	-	±0.1	±1.0		μA	V <sub>I</sub> = V <sub>CC</sub> , GND
I <sub>OZ</sub>	Maximum 3-State Current	5.5	-	±0.5	±5.0		μA	V <sub>I</sub> (OE) = V <sub>IL</sub> , V <sub>IH</sub> V <sub>I</sub> = V <sub>CC</sub> , GND V <sub>O</sub> = V <sub>CC</sub> , GND
I <sub>OLD</sub>	†Minimum Dynamic Output Current	5.5	-	-	75		mA	V <sub>OLD</sub> = 1.65 V Max
I <sub>OHD</sub>		5.5	-	-	-75		mA	V <sub>OHD</sub> = 3.85 V Min
I <sub>CC</sub>	Maximum Quiescent Supply Current	5.5	-	8.0	80		μA	V <sub>IN</sub> = V <sub>CC</sub> or GND

Product parametric performance is indicated in the Electrical Characteristics for the listed test conditions, unless otherwise noted. Product performance may not be indicated by the Electrical Characteristics if operated under different conditions.

\*All outputs loaded; thresholds on input associated with output under test.

†Maximum test duration 2.0 ms, one output loaded at a time.

NOTE: I<sub>IN</sub> and I<sub>CC</sub> @ 3.0 V are guaranteed to be less than or equal to the respective limit @ 5.5 V V<sub>CC</sub>.

# MC74AC373, MC74ACT373

## AC CHARACTERISTICS (For Figures and Waveforms – See AND8277/D at www.onsemi.com)

Symbol	Parameter	V <sub>CC</sub> * (V)	74AC			74AC		Unit	Fig. No.
			T <sub>A</sub> = +25°C C <sub>L</sub> = 50 pF			T <sub>A</sub> = -40°C to +85°C C <sub>L</sub> = 50 pF			
			Min	Typ	Max	Min	Max		
t <sub>PLH</sub>	Propagation Delay D <sub>n</sub> to O <sub>n</sub>	3.3 5.0	1.5 1.5	10 7.0	13.5 9.5	1.5 1.5	15 10.5	ns	3-5
t <sub>PHL</sub>	Propagation Delay D <sub>n</sub> to O <sub>n</sub>	3.3 5.0	1.5 1.5	9.5 7.0	13 9.5	1.5 1.5	14.5 10.5	ns	3-5
t <sub>PLH</sub>	Propagation Delay LE to O <sub>n</sub>	3.3 5.0	1.5 1.5	10 7.5	13.5 9.5	1.5 1.5	15 10.5	ns	3-6
t <sub>PHL</sub>	Propagation Delay LE to O <sub>n</sub>	3.3 5.0	1.5 1.5	9.5 7.0	12.5 9.5	1.5 1.5	14 10.5	ns	3-6
t <sub>PZH</sub>	Output Enable Time	3.3 5.0	1.5 1.5	9.0 7.0	11.5 8.5	1.0 1.0	13 9.5	ns	3-7
t <sub>PZL</sub>	Output Enable Time	3.3 5.0	1.5 1.5	8.5 6.5	11.5 8.5	1.0 1.0	13 9.5	ns	3-8
t <sub>PHZ</sub>	Output Disable Time	3.3 5.0	1.5 1.5	10 8.0	12.5 11	1.0 1.0	14.5 12.5	ns	3-7
t <sub>PLZ</sub>	Output Disable Time	3.3 5.0	1.5 1.5	8.0 6.5	11.5 8.5	1.0 1.0	12.5 10	ns	3-8

\*Voltage Range 3.3 V is 3.3 V ±0.3 V.  
Voltage Range 5.0 V is 5.0 V ±0.5 V.

## AC OPERATING REQUIREMENTS

Symbol	Parameter	V <sub>CC</sub> * (V)	74AC		74AC		Unit	Fig. No.
			T <sub>A</sub> = +25°C C <sub>L</sub> = 50 pF		T <sub>A</sub> = -40°C to +85°C C <sub>L</sub> = 50 pF			
			Typ	Guaranteed Minimum				
t <sub>s</sub>	Setup Time, HIGH or LOW D <sub>n</sub> to LE	3.3 5.0	3.5 2.0	5.5 4.0	6.0 4.5		ns	3-9
t <sub>h</sub>	Hold Time, HIGH or LOW D <sub>n</sub> to LE	3.3 5.0	-3.0 -1.5	1.0 1.0	1.0 1.0		ns	3-9
t <sub>w</sub>	LE Pulse Width, HIGH	3.3 5.0	4.0 2.0	5.5 4.0	6.0 4.5		ns	3-6

\*Voltage Range 3.3 V is 3.3 V ±0.3 V.  
Voltage Range 5.0 V is 5.0 V ±0.5 V.

# MC74AC373, MC74ACT373

## DC CHARACTERISTICS

Symbol	Parameter	V <sub>CC</sub> (V)	74ACT		74ACT		Unit	Conditions
			T <sub>A</sub> = +25°C		T <sub>A</sub> = -40°C to +85°C			
			Typ	Guaranteed Limits				
V <sub>IH</sub>	Minimum High Level Input Voltage	4.5	1.5	2.0	2.0		V	V <sub>OUT</sub> = 0.1 V or V <sub>CC</sub> - 0.1 V
		5.5	1.5	2.0	2.0			
V <sub>IL</sub>	Maximum Low Level Input Voltage	4.5	1.5	0.8	0.8		V	V <sub>OUT</sub> = 0.1 V or V <sub>CC</sub> - 0.1 V
		5.5	1.5	0.8	0.8			
V <sub>OH</sub>	Minimum High Level Output Voltage	4.5	4.49	4.4	4.4		V	I <sub>OUT</sub> = -50 μA
		5.5	5.49	5.4	5.4			
		4.5	-	3.86	3.76		V	*V <sub>IN</sub> = V <sub>IL</sub> or V <sub>IH</sub> I <sub>OH</sub> -24 mA -24 mA
5.5	-	4.86	4.76					
V <sub>OL</sub>	Maximum Low Level Output Voltage	4.5	0.001	0.1	0.1		V	I <sub>OUT</sub> = 50 μA
		5.5	0.001	0.1	0.1			
		4.5	-	0.36	0.44		V	*V <sub>IN</sub> = V <sub>IL</sub> or V <sub>IH</sub> 24 mA I <sub>OL</sub> 24 mA
5.5	-	0.36	0.44					
I <sub>IN</sub>	Maximum Input Leakage Current	5.5	-	±0.1	±1.0		μA	V <sub>I</sub> = V <sub>CC</sub> , GND
ΔI <sub>CCT</sub>	Additional Max. I <sub>CC</sub> /Input	5.5	0.6	-	1.5		mA	V <sub>I</sub> = V <sub>CC</sub> - 2.1 V
I <sub>OZ</sub>	Maximum 3-State Current	5.5	-	±0.5	±5.0		μA	V <sub>I</sub> (OE) = V <sub>IL</sub> , V <sub>IH</sub> V <sub>I</sub> = V <sub>CC</sub> , GND V <sub>O</sub> = V <sub>CC</sub> , GND
I <sub>OLD</sub>	†Minimum Dynamic Output Current	5.5	-	-	75		mA	V <sub>OLD</sub> = 1.65 V Max
I <sub>OHD</sub>		5.5	-	-	-75		mA	V <sub>OHD</sub> = 3.85 V Min
I <sub>CC</sub>	Maximum Quiescent Supply Current	5.5	-	8.0	80		μA	V <sub>IN</sub> = V <sub>CC</sub> or GND

\*All outputs loaded; thresholds on input associated with output under test.

†Maximum test duration 2.0 ms, one output loaded at a time.

# MC74AC373, MC74ACT373

**AC CHARACTERISTICS** (For Figures and Waveforms – See AND8277/D at [www.onsemi.com](http://www.onsemi.com))

Symbol	Parameter	V <sub>CC</sub> * (V)	74ACT			74ACT		Unit	Fig. No.
			T <sub>A</sub> = +25°C C <sub>L</sub> = 50 pF			T <sub>A</sub> = -40°C to +85°C C <sub>L</sub> = 50 pF			
			Min	Typ	Max	Min	Max		
t <sub>PLH</sub>	Propagation Delay D <sub>n</sub> to O <sub>n</sub>	5.0	2.5	8.5	10	1.5	11.5	ns	3-5
t <sub>PHL</sub>	Propagation Delay D <sub>n</sub> to O <sub>n</sub>	5.0	2.0	8.0	10	1.5	11.5	ns	3-5
t <sub>PLH</sub>	Propagation Delay LE to O <sub>n</sub>	5.0	2.5	8.5	11	2.0	11.5	ns	3-6
t <sub>PHL</sub>	Propagation Delay LE to O <sub>n</sub>	5.0	2.0	8.0	10	1.5	11.5	ns	3-6
t <sub>PZH</sub>	Output Enable Time	5.0	2.0	8.0	9.5	1.5	10.5	ns	3-7
t <sub>PZL</sub>	Output Enable Time	5.0	2.0	7.5	9.0	1.5	10.5	ns	3-8
t <sub>PHZ</sub>	Output Disable Time	5.0	2.5	9.0	11	2.5	12.5	ns	3-7
t <sub>PLZ</sub>	Output Disable Time	5.0	1.5	7.5	8.5	1.0	10	ns	3-8

\*Voltage Range 5.0 V is 5.0 V ±0.5 V.

**AC OPERATING REQUIREMENTS** (For Figures and Waveforms – See AND8277/D at [www.onsemi.com](http://www.onsemi.com))

Symbol	Parameter	V <sub>CC</sub> * (V)	74ACT		74ACT		Unit	Fig. No.
			T <sub>A</sub> = +25°C C <sub>L</sub> = 50 pF		T <sub>A</sub> = -40°C to +85°C C <sub>L</sub> = 50 pF			
			Typ	Guaranteed Minimum				
t <sub>s</sub>	Setup Time, HIGH or LOW D <sub>n</sub> to LE	5.0	3.0	7.0	8.0	ns	3-9	
t <sub>h</sub>	Hold Time, HIGH or LOW D <sub>n</sub> to LE	5.0	0	0	1.0	ns	3-9	
t <sub>w</sub>	LE Pulse Width, HIGH	5.0	2.0	7.0	8.0	ns	3-6	

\*Voltage Range 5.0 V is 5.0 V ±0.5 V.

## CAPACITANCE

Symbol	Parameter	Value Typ	Unit	Test Conditions
C <sub>IN</sub>	Input Capacitance	4.5	pF	V <sub>CC</sub> = 5.0 V
C <sub>PD</sub>	Power Dissipation Capacitance	40	pF	V <sub>CC</sub> = 5.0 V

# MC74AC373, MC74ACT373

## ORDERING INFORMATION

Device	Package	Shipping†
MC74AC373DWG	SOIC-20 (Pb-Free)	38 Units / Rail
MC74AC373DWR2G	SOIC-20 (Pb-Free)	1000 / Tape & Reel
MC74ACT373DWG	SOIC-20 (Pb-Free)	38 Units / Rail
MC74ACT373DWR2G	SOIC-20 (Pb-Free)	1000 / Tape & Reel
MC74AC373DTG	TSSOP-20 (Pb-Free)	75 Units / Rail
MC74AC373DTR2G	TSSOP-20 (Pb-Free)	2500 / Tape & Reel
MC74ACT373DTG	TSSOP-20 (Pb-Free)	75 Units / Rail
MC74ACT373DTR2G	TSSOP-20 (Pb-Free)	2500 / Tape & Reel

†For information on tape and reel specifications, including part orientation and tape sizes, please refer to our Tape and Reel Packaging Specifications Brochure, BRD8011/D.

## MARKING DIAGRAMS

SOIC-20W

TSSOP-20

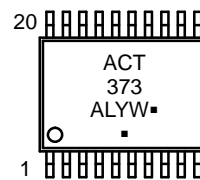
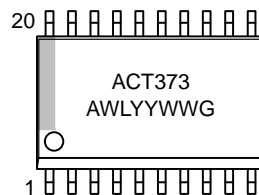
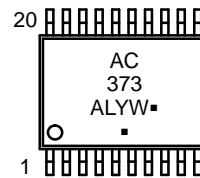
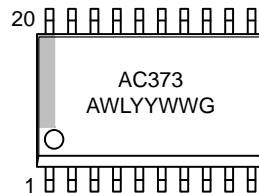

A = Assembly Location  
 WL, L = Wafer Lot  
 YY, Y = Year  
 WW, W = Work Week  
 G or ▪ = Pb-Free Package  
 (Note: Microdot may be in either location)



# MECHANICAL CASE OUTLINE

## PACKAGE DIMENSIONS

ON Semiconductor®

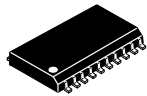

SCALE 1:1

SOIC-20 WB  
CASE 751D-05  
ISSUE H

DATE 22 APR 2015



NOTES:

1. DIMENSIONS ARE IN MILLIMETERS.
2. INTERPRET DIMENSIONS AND TOLERANCES PER ASME Y14.5M, 1994.
3. DIMENSIONS D AND E DO NOT INCLUDE MOLD PROTRUSION.
4. MAXIMUM MOLD PROTRUSION 0.15 PER SIDE.
5. DIMENSION B DOES NOT INCLUDE DAMBAR PROTRUSION. ALLOWABLE PROTRUSION SHALL BE 0.13 TOTAL IN EXCESS OF B DIMENSION AT MAXIMUM MATERIAL CONDITION.

DIM	MILLIMETERS	
	MIN	MAX
A	2.35	2.65
A1	0.10	0.25
b	0.35	0.49
c	0.23	0.32
D	12.65	12.95
E	7.40	7.60
e	1.27 BSC	
H	10.05	10.55
h	0.25	0.75
L	0.50	0.90
θ	0°	7°

RECOMMENDED  
SOLDERING FOOTPRINT\*

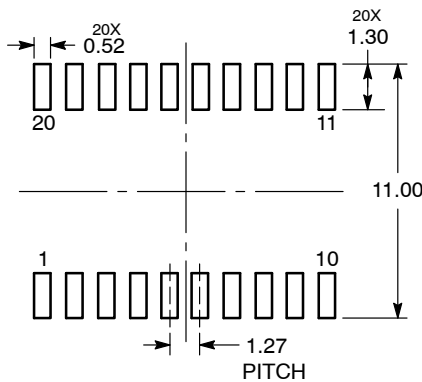

DIMENSIONS: MILLIMETERS

\*For additional information on our Pb-Free strategy and soldering details, please download the ON Semiconductor Soldering and Mounting Techniques Reference Manual, SOLDERRM/D.

GENERIC  
MARKING DIAGRAM\*

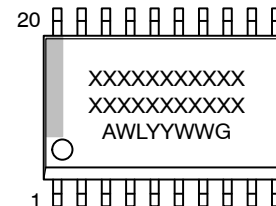

- XXXXXX = Specific Device Code
- A = Assembly Location
- WL = Wafer Lot
- YY = Year
- WW = Work Week
- G = Pb-Free Package

\*This information is generic. Please refer to device data sheet for actual part marking. Pb-Free indicator, "G" or microdot "▪", may or may not be present.

DOCUMENT NUMBER:	98ASB42343B	Electronic versions are uncontrolled except when accessed directly from the Document Repository. Printed versions are uncontrolled except when stamped "CONTROLLED COPY" in red.
DESCRIPTION:	SOIC-20 WB	PAGE 1 OF 1

ON Semiconductor and ON are trademarks of Semiconductor Components Industries, LLC dba ON Semiconductor or its subsidiaries in the United States and/or other countries. ON Semiconductor reserves the right to make changes without further notice to any products herein. ON Semiconductor makes no warranty, representation or guarantee regarding the suitability of its products for any particular purpose, nor does ON Semiconductor assume any liability arising out of the application or use of any product or circuit, and specifically disclaims any and all liability, including without limitation special, consequential or incidental damages. ON Semiconductor does not convey any license under its patent rights nor the rights of others.

# MECHANICAL CASE OUTLINE

## PACKAGE DIMENSIONS

ON Semiconductor®



TSSOP-20 WB  
CASE 948E  
ISSUE D

DATE 17 FEB 2016

SCALE 2:1



NOTES:

1. DIMENSIONING AND TOLERANCING PER ANSI Y14.5M, 1982.
2. CONTROLLING DIMENSION: MILLIMETER.
3. DIMENSION A DOES NOT INCLUDE MOLD FLASH, PROTRUSIONS OR GATE BURRS. MOLD FLASH OR GATE BURRS SHALL NOT EXCEED 0.15 (0.006) PER SIDE.
4. DIMENSION B DOES NOT INCLUDE INTERLEAD FLASH OR PROTRUSION. INTERLEAD FLASH OR PROTRUSION SHALL NOT EXCEED 0.25 (0.010) PER SIDE.
5. DIMENSION K DOES NOT INCLUDE DAMBAR PROTRUSION. ALLOWABLE DAMBAR PROTRUSION SHALL BE 0.08 (0.003) TOTAL IN EXCESS OF THE K DIMENSION AT MAXIMUM MATERIAL CONDITION.
6. TERMINAL NUMBERS ARE SHOWN FOR REFERENCE ONLY.
7. DIMENSION A AND B ARE TO BE DETERMINED AT DATUM PLANE -W-.

DIM	MILLIMETERS		INCHES	
	MIN	MAX	MIN	MAX
A	6.40	6.60	0.252	0.260
B	4.30	4.50	0.169	0.177
C	---	1.20	---	0.047
D	0.05	0.15	0.002	0.006
F	0.50	0.75	0.020	0.030
G	0.65 BSC		0.026 BSC	
H	0.27	0.37	0.011	0.015
J	0.09	0.20	0.004	0.008
J1	0.09	0.16	0.004	0.006
K	0.19	0.30	0.007	0.012
K1	0.19	0.25	0.007	0.010
L	6.40 BSC		0.252 BSC	
M	0°	8°	0°	8°



SOLDERING FOOTPRINT



GENERIC MARKING DIAGRAM\*



- A = Assembly Location
- L = Wafer Lot
- Y = Year
- W = Work Week
- = Pb-Free Package

(Note: Microdot may be in either location)

\*This information is generic. Please refer to device data sheet for actual part marking. Pb-Free indicator, "G" or microdot "▪", may or may not be present.

DOCUMENT NUMBER:	98ASH70169A	Electronic versions are uncontrolled except when accessed directly from the Document Repository. Printed versions are uncontrolled except when stamped "CONTROLLED COPY" in red.
DESCRIPTION:	TSSOP-20 WB	PAGE 1 OF 1

ON Semiconductor and ON are trademarks of Semiconductor Components Industries, LLC dba ON Semiconductor or its subsidiaries in the United States and/or other countries. ON Semiconductor reserves the right to make changes without further notice to any products herein. ON Semiconductor makes no warranty, representation or guarantee regarding the suitability of its products for any particular purpose, nor does ON Semiconductor assume any liability arising out of the application or use of any product or circuit, and specifically disclaims any and all liability, including without limitation special, consequential or incidental damages. ON Semiconductor does not convey any license under its patent rights nor the rights of others.