

Single Inverter with Schmitt-Trigger Input

MC74HC1G14

The MC74HC1G14 is a high speed CMOS inverter with Schmitt-Trigger input fabricated with silicon gate CMOS technology. The internal circuit is composed of multiple stages, including a buffer output which provides high noise immunity and stable output. The MC74HC1G14 output drive current is 1/2 compared to MC74HC series.

Features

- High Speed: $t_{PD} = 7 \text{ ns}$ (Typ) at $V_{CC} = 5 \text{ V}$
- Low Power Dissipation: $I_{CC} = 1 \mu\text{A}$ (Max) at $T_A = 25^\circ\text{C}$
- High Noise Immunity
- Balanced Propagation Delays ($t_{pLH} = t_{pHL}$)
- Symmetrical Output Impedance ($I_{OH} = I_{OL} = 2 \text{ mA}$)
- Chip Complexity: < 100 FETs
- -Q Suffix for Automotive and Other Applications Requiring Unique Site and Control Change Requirements; AEC-Q100 Qualified and PPAP Capable
- These Devices are Pb-Free, Halogen Free/BFR Free and are RoHS Compliant

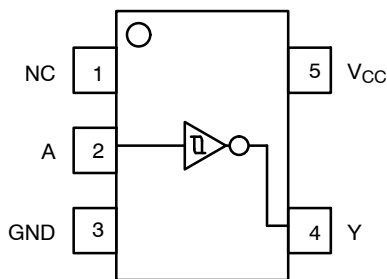

Figure 1. Pinout

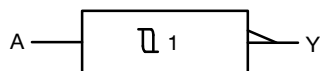

Figure 2. Logic Symbol

PIN ASSIGNMENT	
1	N/C
2	A
3	GND
4	Y
5	V _{CC}



SC-88A
DF SUFFIX
CASE 419A

MARKING DIAGRAMS

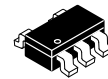
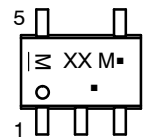

TSOP-5
DT SUFFIX
CASE 483

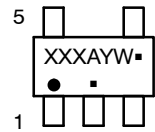
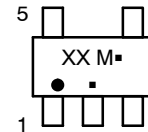

- XX = Device Code
- M = Date Code*
- A = Assembly Location
- Y = Year
- W = Work Week
- = Pb-Free Package

(Note: Microdot may be in either location)
*Date Code orientation and/or position may vary depending upon manufacturing location.



SC-74A
DBV SUFFIX
CASE 318BQ

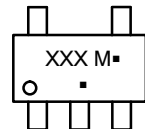

- XXX = Specific Device Code
 - M = Date Code
 - = Pb-Free Package
- (Note: Microdot may be in either location)

FUNCTION TABLE

Input	Output
A	Y
L	H
H	L

ORDERING INFORMATION

See detailed ordering, marking and shipping information in the package dimensions section on page 5 of this data sheet.

MC74HC1G14

MAXIMUM RATINGS

Symbol	Parameter	Value	Unit	
V _{CC}	DC Supply Voltage	-0.5 to +6.5	V	
V _{IN}	DC Input Voltage	-0.5 to V _{CC} +0.5	V	
V _{OUT}	DC Output Voltage	-0.5 to V _{CC} +0.5	V	
I _{IK}	DC Input Diode Current	±20	mA	
I _{OK}	DC Output Diode Current	±20	mA	
I _{OUT}	DC Output Source/Sink Current	±12.5	mA	
I _{CC} or I _{IGND}	DC Supply Current per Supply Pin or Ground Pin	±25	mA	
T _{STG}	Storage Temperature Range	-65 to +150	°C	
T _L	Lead Temperature, 1 mm from Case for 10 Seconds	260	°C	
T _J	Junction Temperature Under Bias	+150	°C	
θ _{JA}	Thermal Resistance (Note 1)	SC-88A SC-74A	377 320	°C/W
P _D	Power Dissipation in Still Air	SC-88A SC-74A	332 390	mW
MSL	Moisture Sensitivity	Level 1		
F _R	Flammability Rating	Oxygen Index: 28 to 34	UL 94 V-0 @ 0.125 in	
V _{ESD}	ESD Withstand Voltage (Note 2)	Human Body Model Charged Device Model	2000 1000	V
I _{LATCHUP}	Latchup Performance (Note 3)	±100		mA

Stresses exceeding those listed in the Maximum Ratings table may damage the device. If any of these limits are exceeded, device functionality should not be assumed, damage may occur and reliability may be affected.

1. Measured with minimum pad spacing on an FR4 board, using 10 mm-by-1 inch, 20 ounce copper trace with no air flow per JESD51-7.
2. HBM tested to ANSI/ESDA/JEDEC JS-001-2017. CDM tested to JESD22-C101-F. JEDEC recommends that ESD qualification to EIA/JESD22-A115A (Machine Model) be discontinued per JEDEC/JEP172A.
3. Tested to EIA/JESD78 Class II.

RECOMMENDED OPERATING CONDITIONS

Symbol	Parameter	Min	Max	Unit	
V _{CC}	DC Supply Voltage	2.0	6.0	V	
V _{IN}	DC Input Voltage	0.0	V _{CC}	V	
V _{OUT}	DC Output Voltage	0.0	V _{CC}	V	
T _A	Operating Temperature Range	-55	+125	°C	
t _r , t _f	Input Rise and Fall Time				
		V _{CC} = 2.0 V	-	No Limit	ns/V
		V _{CC} = 2.3 V to 2.7 V	-	No Limit	
		V _{CC} = 3.0 V to 3.6 V	-	No Limit	
		V _{CC} = 4.5 V to 6.0 V	-	No Limit	

Functional operation above the stresses listed in the Recommended Operating Ranges is not implied. Extended exposure to stresses beyond the Recommended Operating Ranges limits may affect device reliability.

MC74HC1G14

DC ELECTRICAL CHARACTERISTICS

Symbol	Parameter	Test Conditions	V _{CC} (V)	T _A = 25°C			-40°C ≤ T _A ≤ 85°C		-55°C ≤ T _A ≤ 125°C		Unit				
				Min	Typ	Max	Min	Max	Min	Max					
V _{T+}	Positive Threshold Voltage		3.0	-	2.0	2.2	-	2.2	-	2.2	V				
			4.5	-	3.0	3.15	-	3.15	-	3.15					
			5.5	-	3.6	3.85	-	3.85	-	3.85					
V _{T-}	Negative Threshold Voltage		3.0	0.9	1.5	-	0.9	-	0.9	-	V				
			4.5	1.35	2.3	-	1.35	-	1.35	-					
			5.5	1.65	2.9	-	1.65	-	1.65	-					
V _H	Hysteresis Voltage		3.0	0.30	0.57	1.20	0.30	1.20	0.30	1.20	V				
			4.5	0.40	0.67	1.40	0.40	1.40	0.40	1.40					
			5.5	0.50	0.74	1.60	0.50	1.60	0.50	1.60					
V _{OH}	High-Level Output Voltage	V _{IN} = V _{IH} or V _{IL} I _{OH} = -20 μA	2.0	1.9	2.0	-	1.9	-	1.9	-	V				
			3.0	2.9	3.0	-	2.9	-	2.9	-					
			4.5	4.4	4.5	-	4.4	-	4.4	-					
			6.0	5.9	6.0	-	5.9	-	5.9	-					
		V _{IN} = V _{IH} or V _{IL} I _{OH} = -2 mA I _{OH} = -2.6 mA	4.5	4.18	4.31	-	4.13	-	4.08	-					
			6.0	5.68	5.80	-	5.63	-	5.58	-					
			V _{OL}	Low-Level Output Voltage	V _{IN} = V _{IH} or V _{IL} I _{OL} = 20 μA	2.0	-	0.0	0.1	-		0.1	-	0.1	V
						3.0	-	0.0	0.1	-		0.1	-	0.1	
		V _{IN} = V _{IH} or V _{IL} I _{OL} = 2 mA I _{OL} = 2.6 mA	4.5	-	0.0	0.1	-	0.1	-	0.1					
			6.0	-	0.0	0.1	-	0.1	-	0.1					
I _{IN}	Input Leakage Current	V _{IN} = 6.0 V or GND	6.0	-	-	±0.1	-	±1.0	-	±1.0	μA				
			I _{CC}	Quiescent Supply Current	V _{IN} = V _{CC} or GND	6.0	-	-	1.0	-		10	-	40	μA

AC ELECTRICAL CHARACTERISTICS

Symbol	Parameter	Test Conditions	T _A = 25°C			-40°C ≤ T _A ≤ 85°C		-55°C ≤ T _A ≤ 125°C		Unit
			Min	Typ	Max	Min	Max	Min	Max	
t _{PLH} , t _{PHL}	Propagation Delay, Input A or B to Y	V _{CC} = 5.0 V C _L = 15 pF	-	3.5	15	-	20	-	25	ns
		V _{CC} = 2.0 V C _L = 50 pF	-	19	100	-	125	-	155	
		V _{CC} = 3.0 V	-	10.5	27	-	35	-	90	
		V _{CC} = 4.5 V	-	7.5	20	-	25	-	35	
		V _{CC} = 6.0 V	-	6.5	17	-	21	-	26	
t _{TLH} , t _{THL}	Output Transition Time	V _{CC} = 5.0 V C _L = 15 pF	-	3	10	-	15	-	20	ns
		V _{CC} = 2.0 V C _L = 50 pF	-	25	125	-	155	-	200	
		V _{CC} = 3.0 V	-	16	35	-	45	-	60	
		V _{CC} = 4.5 V	-	11	25	-	31	-	38	
		V _{CC} = 6.0 V	-	9	21	-	26	-	32	
C _{IN}	Input Capacitance		-	5	10	-	10	-	10	pF

C _{PD}	Power Dissipation Capacitance (Note 4)	Typical @ 25°C, V _{CC} = 5.0 V		pF
		10		

4. C_{PD} is defined as the value of the internal equivalent capacitance which is calculated from the operating current consumption without load. Average operating current can be obtained by the equation: I_{CC(OPR)} = C_{PD} • V_{CC} • f_{in} + I_{CC}. C_{PD} is used to determine the no-load dynamic power consumption; P_D = C_{PD} • V_{CC}² • f_{in} + I_{CC} • V_{CC}.

MC74HC1G14

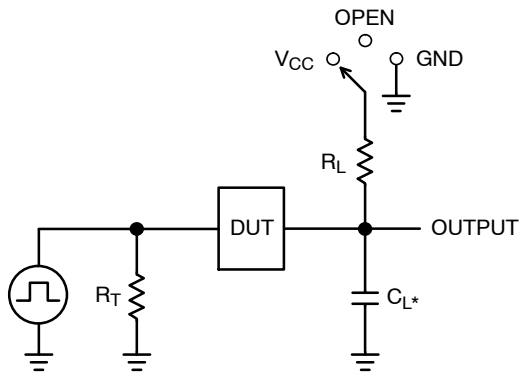

* C_L includes probe and jig capacitance
 R_T is Z_{OUT} of pulse generator (typically 50 Ω)
 $f = 1$ MHz

Figure 3. Test Circuit

Test	Switch Position	C_L , pF	R_L , Ω
t_{PLH} / t_{PHL}	Open	See AC Characteristics Table	X
t_{TLH} / t_{THL} (Note 5)	Open		X
t_{PLZ} / t_{PZL}	V_{CC}		1 k
t_{PHZ} / t_{PZH}	GND		1 k

X - Don't Care



Figure 4. Switching Waveforms

V_{CC} , V	V_{mi} , V	V_{mo} , V		V_L , V	V_H , V	V_Y , V
		t_{PLH} , t_{PHL}	t_{PZL} , t_{PLZ} , t_{PZH} , t_{PHZ}			
3.0 to 3.6	$V_{CC}/2$	$V_{CC}/2$	$V_{CC}/2$	$V_{OL} + 0.1 (V_{OH} - V_{OL})$	$V_{OL} + 0.9 (V_{OH} - V_{OL})$	0.3
4.5 to 5.5	$V_{CC}/2$	$V_{CC}/2$	$V_{CC}/2$	$V_{OL} + 0.1 (V_{OH} - V_{OL})$	$V_{OL} + 0.9 (V_{OH} - V_{OL})$	0.3

5. t_{TLH} and t_{THL} are measured from 10% to 90% of $(V_{OH} - V_{OL})$, and 90% to 10% of $(V_{OH} - V_{OL})$, respectively.

MC74HC1G14

ORDERING INFORMATION

Device	Packages	Specific Device Code	Pin 1 Orientation (See below)	Shipping†
MC74HC1G14DFT1G	SC-88A	HA	Q2	3000 / Tape & Reel
MC74HC1G14DFT1G-Q* (Please contact onsemi)	SC-88A	HA	Q2	3000 / Tape & Reel
MC74HC1G14DFT2G	SC-88A	HA	Q4	3000 / Tape & Reel
MC74HC1G14DFT2G-Q* (Please contact onsemi)	SC-88A	HA	Q4	3000 / Tape & Reel
MC74HC1G14DTT1G-Q* (Please contact onsemi)	TSOP-5	HA	Q4	3000 / Tape & Reel
MC74HC1G14DBVT1G	SC-74A	HA	Q4	3000 / Tape & Reel
MC74HC1G14DBVT1G-Q* (Please contact onsemi)	SC-74A	HA	Q4	3000 / Tape & Reel

†For complete information on tape and reel specifications, including part orientation and tape sizes, please refer to our Tape and Reel Packaging Specifications Brochure, BRD8011/D.

*-Q Suffix for Automotive and Other Applications Requiring Unique Site and Control Change Requirements; AEC-Q100 Qualified and PPAP Capable.

Pin 1 Orientation in Tape and Reel

Direction of Feed

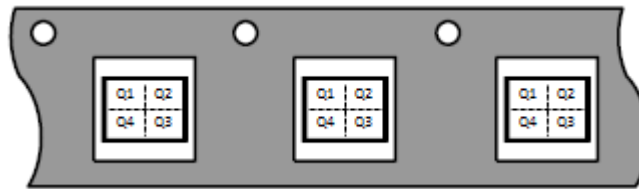

MC74HC1G14

PACKAGE DIMENSIONS

TSOP-5
CASE 483
ISSUE N

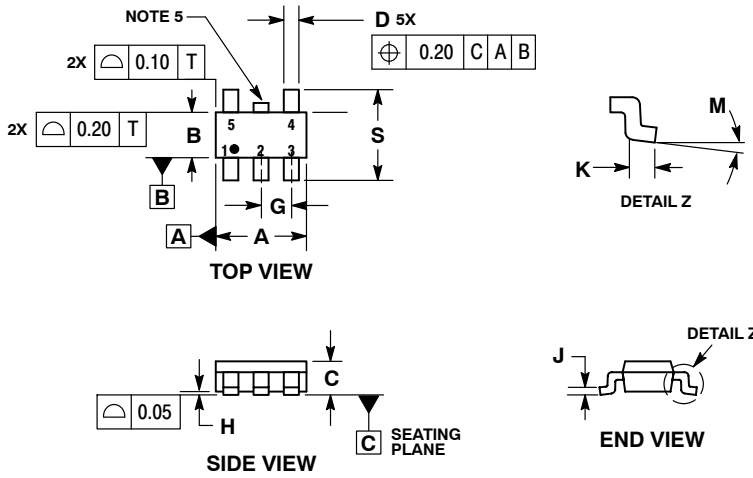

NOTES:

1. DIMENSIONING AND TOLERANCING PER ASME Y14.5M, 1994.
2. CONTROLLING DIMENSION: MILLIMETERS.
3. MAXIMUM LEAD THICKNESS INCLUDES LEAD FINISH THICKNESS. MINIMUM LEAD THICKNESS IS THE MINIMUM THICKNESS OF BASE MATERIAL.
4. DIMENSIONS A AND B DO NOT INCLUDE MOLD FLASH, PROTRUSIONS, OR GATE BURRS. MOLD FLASH, PROTRUSIONS, OR GATE BURRS SHALL NOT EXCEED 0.15 PER SIDE. DIMENSION A.
5. OPTIONAL CONSTRUCTION: AN ADDITIONAL TRIMMED LEAD IS ALLOWED IN THIS LOCATION. TRIMMED LEAD NOT TO EXTEND MORE THAN 0.2 FROM BODY.

SOLDERING FOOTPRINT*

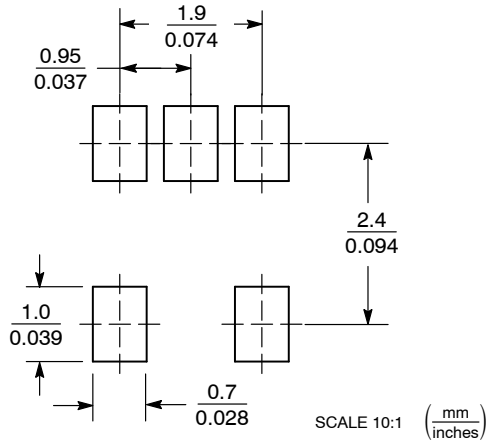

*For additional information on our Pb-Free strategy and soldering details, please download the ON Semiconductor Soldering and Mounting Techniques Reference Manual, SOLDERRM/D.

MECHANICAL CASE OUTLINE

PACKAGE DIMENSIONS

ON Semiconductor®



SCALE 2:1

SC-74A CASE 318BQ ISSUE B

DATE 18 JAN 2018

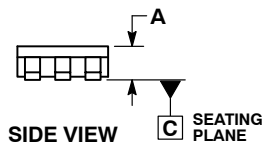
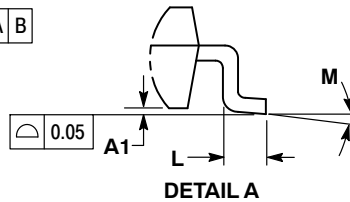
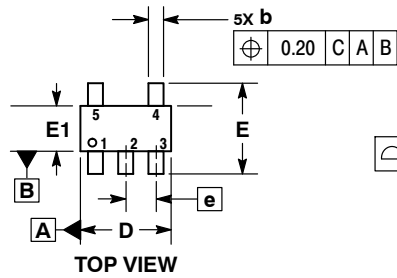

NOTES:

1. DIMENSIONING AND TOLERANCING PER ASME Y14.5M, 1994.
2. CONTROLLING DIMENSION: MILLIMETERS.
3. MAXIMUM LEAD THICKNESS INCLUDES LEAD FINISH THICKNESS. MINIMUM LEAD THICKNESS IS THE MINIMUM THICKNESS OF BASE MATERIAL.
4. DIMENSIONS A AND B DO NOT INCLUDE MOLD FLASH, PROTRUSIONS, OR GATE BURRS. MOLD FLASH, PROTRUSIONS, OR GATE BURRS SHALL NOT EXCEED 0.15 PER SIDE.

DIM	MILLIMETERS	
	MIN	MAX
A	0.90	1.10
A1	0.01	0.10
b	0.25	0.50
c	0.10	0.26
D	2.85	3.15
E	2.50	3.00
E1	1.35	1.65
e	0.95 BSC	
L	0.20	0.60
M	0°	10°

RECOMMENDED SOLDERING FOOTPRINT*



GENERIC MARKING DIAGRAM*

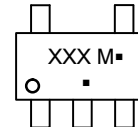

- XXX = Specific Device Code
- M = Date Code
- = Pb-Free Package

(Note: Microdot may be in either location)

*This information is generic. Please refer to device data sheet for actual part marking. Pb-Free indicator, "G" or microdot "▪", may or may not be present. Some products may not follow the Generic Marking.

*For additional information on our Pb-Free strategy and soldering details, please download the ON Semiconductor Soldering and Mounting Techniques Reference Manual, SOLDERRM/D.

DOCUMENT NUMBER:	98AON66279G	Electronic versions are uncontrolled except when accessed directly from the Document Repository. Printed versions are uncontrolled except when stamped "CONTROLLED COPY" in red.
DESCRIPTION:	SC-74A	PAGE 1 OF 1

ON Semiconductor and are trademarks of Semiconductor Components Industries, LLC dba ON Semiconductor or its subsidiaries in the United States and/or other countries. ON Semiconductor reserves the right to make changes without further notice to any products herein. ON Semiconductor makes no warranty, representation or guarantee regarding the suitability of its products for any particular purpose, nor does ON Semiconductor assume any liability arising out of the application or use of any product or circuit, and specifically disclaims any and all liability, including without limitation special, consequential or incidental damages. ON Semiconductor does not convey any license under its patent rights nor the rights of others.

MECHANICAL CASE OUTLINE PACKAGE DIMENSIONS



SCALE 2:1

SC-88A (SC-70-5/SOT-353) CASE 419A-02 ISSUE M

DATE 11 APR 2023



RECOMMENDED
MOUNTING FOOTPRINT

* For additional information on our Pb-Free strategy and soldering details, please download the ON Semiconductor Soldering and Mounting Techniques Reference Manual, SOLDERM/D.

NOTES:

1. DIMENSIONING AND TOLERANCING PER ANSI Y14.5M, 1982.
2. CONTROLLING DIMENSION: MILLIMETERS
3. 419A-01 OBSOLETE. NEW STANDARD 419A-02
4. DIMENSIONS D AND E1 DO NOT INCLUDE MOLD FLASH, PROTRUSIONS, OR GATE BURRS. MOLD FLASH, PROTRUSIONS, OR GATE BURRS SHALL NOT EXCEED 0.1016MM PER SIDE.

DIM	MILLIMETERS		
	MIN.	NOM.	MAX.
A	0.80	0.95	1.10
A1	---	---	0.10
A3	0.20 REF		
b	0.10	0.20	0.30
c	0.10	---	0.25
D	1.80	2.00	2.20
E	2.00	2.10	2.20
E1	1.15	1.25	1.35
e	0.65 BSC		
L	0.10	0.15	0.30

GENERIC MARKING DIAGRAM*

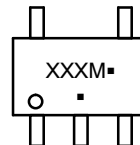

*This information is generic. Please refer to device data sheet for actual part marking. Pb-Free indicator, "G" or microdot "■", may or may not be present. Some products may not follow the Generic Marking.

XXX = Specific Device Code

M = Date Code

■ = Pb-Free Package

(Note: Microdot may be in either location)

STYLE 1:

1. BASE
2. EMITTER
3. BASE
4. COLLECTOR
5. COLLECTOR

STYLE 2:

1. ANODE
2. EMITTER
3. BASE
4. COLLECTOR
5. CATHODE

STYLE 3:

1. ANODE 1
2. N/C
3. ANODE 2
4. CATHODE 2
5. CATHODE 1

STYLE 4:

1. SOURCE 1
2. DRAIN 1/2
3. SOURCE 1
4. GATE 1
5. GATE 2

STYLE 5:

1. CATHODE
2. COMMON ANODE
3. CATHODE 2
4. CATHODE 3
5. CATHODE 4

STYLE 6:

1. EMITTER 2
2. BASE 2
3. EMITTER 1
4. COLLECTOR
5. COLLECTOR 2/BASE 1

STYLE 7:

1. BASE
2. EMITTER
3. BASE
4. COLLECTOR
5. COLLECTOR

STYLE 8:

1. CATHODE
2. COLLECTOR
3. N/C
4. BASE
5. EMITTER

STYLE 9:

1. ANODE
2. CATHODE
3. ANODE
4. ANODE
5. ANODE

Note: Please refer to datasheet for style callout. If style type is not called out in the datasheet refer to the device datasheet pinout or pin assignment.

DOCUMENT NUMBER:	98ASB42984B	Electronic versions are uncontrolled except when accessed directly from the Document Repository. Printed versions are uncontrolled except when stamped "CONTROLLED COPY" in red.
DESCRIPTION:	SC-88A (SC-70-5/SOT-353)	PAGE 1 OF 1

onsemi and ONSEMI are trademarks of Semiconductor Components Industries, LLC dba onsemi or its subsidiaries in the United States and/or other countries. onsemi reserves the right to make changes without further notice to any products herein. onsemi makes no warranty, representation or guarantee regarding the suitability of its products for any particular purpose, nor does onsemi assume any liability arising out of the application or use of any product or circuit, and specifically disclaims any and all liability, including without limitation special, consequential or incidental damages. onsemi does not convey any license under its patent rights nor the rights of others.