

# MC88C



## Rectangular safety magnetic sensors



### Description

The MC88C series are encoded safety magnetic sensors with rectangular housing used to monitor the position of hinged, sliding or removable guards of industrial applications.

Carlo Gavazzi safety sensors stop or disconnect the dangerous motions, if the mobile protections are opened or displaced. They are suitable for safety gates applications up to safety category 4, PLe according to EN ISO 13849-1 with suitable logic safety module.

MC88C sensors are the right answer in harsh industrial environments with damp and dusty condition.

### Benefits

- **Standards compliance.** Up to Cat. 4 PL e in accordance with EN ISO 13849-1.
- **Customizable.** The sensors are available with left or right exit, integrated cable, M8 or pigtail with M12 connector and optionally LED indicator.
- **High performance.** Reinforced polymeric casing (PBT) with a protection degree IP67, operating temperature range from -25°C to +80°C.
- **Rectangular housing.** 88 x 25 x 13 mm.
- **Different outputs.** 2NO, 1NO + 1NC or 2NO + 1NC. (The status of the output is intended without the actuator)
- **Approvals** by CE, cULus

### Applications

The safety magnetic sensors together with the magnetic actuator are particularly suitable to monitor protections of the safety gates that allow the entry to machines with dangerous movements, mainly in environment with strong presence of dust and dirtiness.

When connected to a safety module, the system can reach safety category up to category 4, PL e (EN ISO 13849-1).

### Main functions

- Actuation without mechanical contact for high durability in all environmental conditions.
- Sensors are completely sealed and so insensitive to dirt and dust.
- Suitable for applications with large tolerances or where mechanical features may change over the time, thanks to the wide actuation range.

## References

### Order code

 MC88CH

Enter the code option instead of

Code	Option	Description	Note
M	-	Magnetic	
C	-	Rectangular size	
88	-	88mm length	
C	-	Plastic	
H	-	Reed contact	
<input type="checkbox"/>	20	Contacts: 2 normally open	With open guard
	101C	Contacts: 1 normally open and 1 normally closed	With open guard
	201C	Contacts: 2 normally open and 1 normally closed	With open guard
<input type="checkbox"/>	L	Left exit	
	R	Right exit	
<input type="checkbox"/>	A2	Connection type: PVC cable 2m	
	M5	Connection type: M8 integrated connector	
	T1	Connection type: pig tail with M12 connector	
<input type="checkbox"/>	Null	No LED	
	L	With LED indicator	

### Magnetic actuator

 MC88CM1 (5mm)

 MC88CM2 (8mm)

 MC88CM3 (18mm)

 Type selection

## Left exit



Connection	Output type	LED	Ordering no.
PVC cable 2m	2NO	No	MC88CH2OLA2
		Yes	MC88CH2OLA2L
	1NO + 1NC	No	MC88CH1O1CLA2
		Yes	MC88CH1O1CLA2L
	2NO + 1NC	No	MC88CH2O1CLA2
		Yes	MC88CH2O1CLA2L
M8 integrated connector	2NO	No	MC88CH2OLM5
		Yes	MC88CH2OLM5L
	1NO + 1NC	No	MC88CH1O1CLM5
		Yes	MC88CH1O1CLM5L
Pig tail with M12 connector	2NO	No	MC88CH2OLT1
		Yes	MC88CH2OLT1L
	1NO + 1NC	No	MC88CH1O1CLT1
		Yes	MC88CH1O1CLT1L

## Right exit



Connection	Output type	LED	Ordering no.
PVC cable 2m	2NO	No	MC88CH2ORA2
		Yes	MC88CH2ORA2L
	1NO + 1NC	No	MC88CH1O1CRA2
		Yes	MC88CH1O1CRA2L
	2NO + 1NC	No	MC88CH2O1CRA2
		Yes	MC88CH2O1CRA2L
M8 integrated connector	2NO	No	MC88CH2ORM5
		Yes	MC88CH2ORM5L
	1NO + 1NC	No	MC88CH1O1CRM5
		Yes	MC88CH1O1CRM5L
Pig tail with M12 connector	2NO	No	MC88CH2ORT1
		Yes	MC88CH2ORT1L
	1NO + 1NC	No	MC88CH1O1CRT1
		Yes	MC88CH1O1CRT1L

## Structure

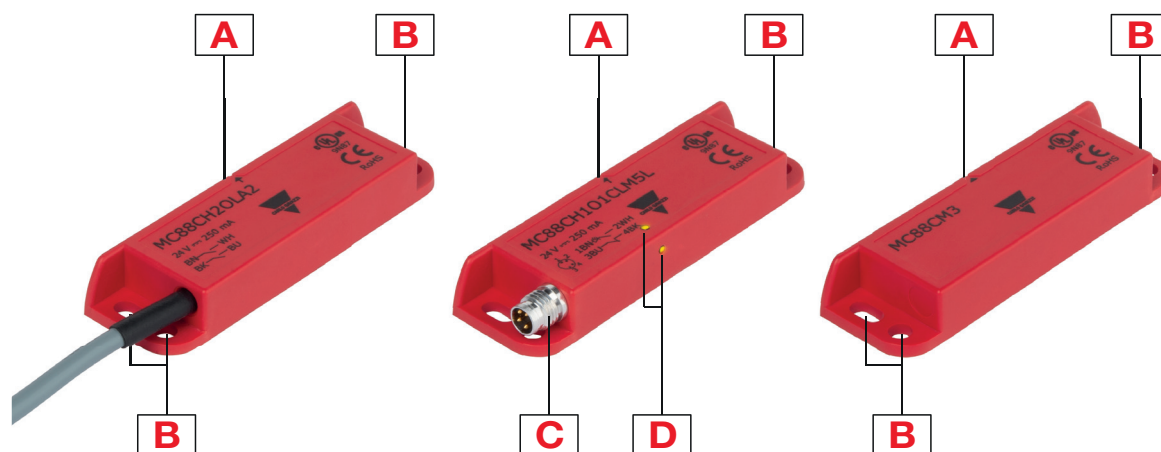

Element	Component
A	Sensing face
B	Screw hole
C	M8, 4 pin, male connector
D	LED

## Dimensions [mm]

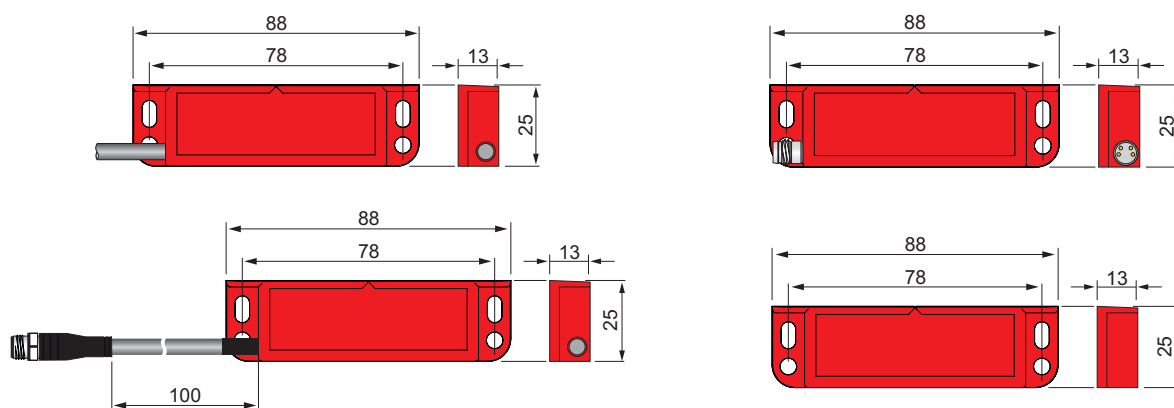

## Sensing

### Detection

<b>Assured switching distance (<math>S_{ao}</math>)</b>	5mm with actuator MC88CM1 8mm with actuator MC88CM2 18mm with actuator MC88CM3
<b>Assured switch-off distance (<math>S_{ar}</math>)</b>	15mm with actuator MC88CM1 18mm with actuator MC88CM2 30mm with actuator MC88CM3
<b>Minimum distance between two sensors</b>	50 mm

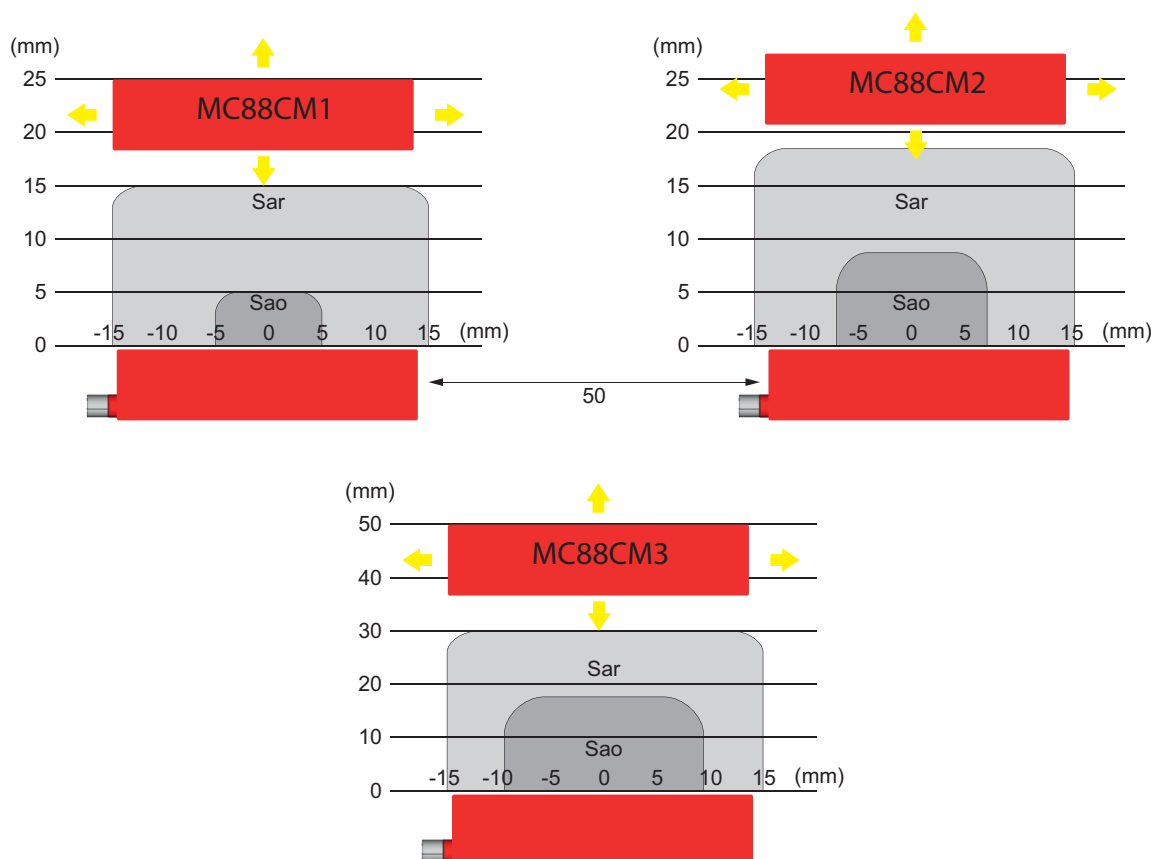

Note: the typical detection characteristic shown may vary from sensor to sensor.

### Accuracy

<b>Repeat accuracy (R)</b>	$\leq 10\%$
----------------------------	-------------



## Features

### Outputs

LED indication	Yellow (optional)
Type	2NO, 1NO+1NC, 2NO+1NC Reed contact
Rated operating voltage ( $U_e$ )	12-24 Vac/dc
Rated operating current ( $I_e$ )	0.25 A (resistive load)
Max switching load	6 W (resistive load)
Rated insulation voltage $U_i$ (IEC EN 60947-1)	120 Vac (with cable / M12) 60 Vac / 75 Vdc (with M8 connector)
Rated impulse withstand voltage $U_{imp}$ Line-to-ground (1.2/50 $\mu$ s) Ri 500 $\Omega$	6 KV / 1.5 KV (with M8 connector)
Protection class	III
Reverse polarity protection	Yes

### Response times

Max. operating frequency (f)	100 Hz
Response time	< 10 ms

### Environmental

Operating temperature	-25° to +80°C (-13° to +176°F)
Storage temperature	-25° to +80°C (-13° to +176°F)
Vibration resistance EN 60068-2-6	10 g (10...150 Hz)
Shock resistance EN 60068-2-27	30 g (11 ms)
Degree of protection EN 60529	IP67
Pollution degree IEC 60947-5-1	3

### Mechanical data

Housing material	PBT red
Weight	85 g
Max torque for M8 version	1.5 Nm



- Use non-magnetic screw only.
- Fasten steadfastly the sensor and the actuator to the safety device (by means of rivets, tamper-proof screws, etc.).
- Fasten the sensor on plane surfaces only, in order to avoid possible distortions that could damage the sensor or alter switching distances.
- To activate the safety sensors it is necessary to use the proper coded actuator MC88CMx. Conventional magnets cannot be used.
- The sensor and actuator central reference marks must be opposed and aligned.

## Electrical connection

Connection type	2m PVC cable 4 x 0.25 mm <sup>2</sup>
	M8 4-pin connector
	Pig tail: PVC cable / 0.1 m; Ø 5 mm; with M12 connector

## Compatibility and conformity

Conforms to the standards	EN/IEC 60947-5-1
Conforms to the directive	2006/42/CE Machinery Directive 2014/35/EU LVD Directive 2014/30/EU Electromagnetic Compatibility Directive 2011/65/UE RoHS Directive
Electrostatic discharge (ESD)	IEC 61000-4-2 15KV Air discharge, 8KV Contact discharge
Performance level (PL)	PL e - according to EN ISO 13849-1*
Safety category	Up to 4 - according to EN ISO 13849-1*
Terminal marking	In accordance with IEC 60947-5-1
B10d for each channel	700.000 operations (@ 250mA resistive load) Mechanical endurance: 80 millions operations
Approvals	

\* When connected to a safety module

# Connection Diagrams

## Cable version

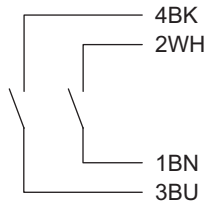

Fig. 1 2 NO (without LED)

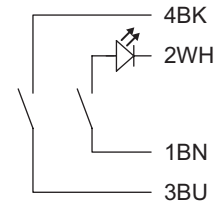

Fig. 2 2 NO (with LED)

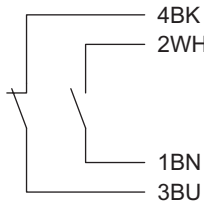

Fig. 3 1 NO + 1 NC (without LED)

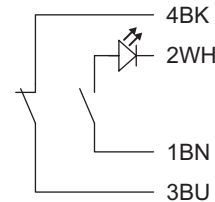

Fig. 4 1 NO + 1 NC (with LED)

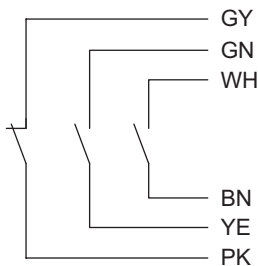

Fig. 5 2 NO + 1 NC (without LED)

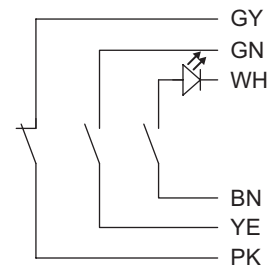

Fig. 6 2 NO + 1 NC (with LED)

Colour code							
BN: Brown	WH: White	BK: Black	BU: Blue	GN: Green	GY: Grey	YE: Yellow	PK: Pink

## M8 connector version

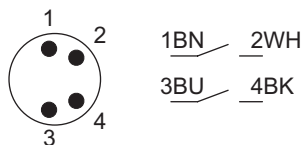

Fig. 7 2 NO (without LED)

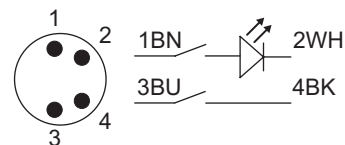

Fig. 8 2 NO (with LED)

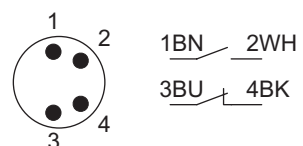

Fig. 9 1 NO + 1 NC (without LED)

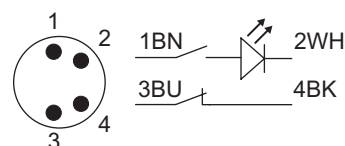

Fig. 10 1 NO + 1 NC (with LED)