



**MICROCHIP**

---

**MCP7382X**  
**Evaluation Kit**  
**User's Guide**

---

**Note the following details of the code protection feature on Microchip devices:**

- Microchip products meet the specification contained in their particular Microchip Data Sheet.
- Microchip believes that its family of products is one of the most secure families of its kind on the market today, when used in the intended manner and under normal conditions.
- There are dishonest and possibly illegal methods used to breach the code protection feature. All of these methods, to our knowledge, require using the Microchip products in a manner outside the operating specifications contained in Microchip's Data Sheets. Most likely, the person doing so is engaged in theft of intellectual property.
- Microchip is willing to work with the customer who is concerned about the integrity of their code.
- Neither Microchip nor any other semiconductor manufacturer can guarantee the security of their code. Code protection does not mean that we are guaranteeing the product as "unbreakable."

Code protection is constantly evolving. We at Microchip are committed to continuously improving the code protection features of our products. Attempts to break Microchip's code protection feature may be a violation of the Digital Millennium Copyright Act. If such acts allow unauthorized access to your software or other copyrighted work, you may have a right to sue for relief under that Act.

---

Information contained in this publication regarding device applications and the like is provided only for your convenience and may be superseded by updates. It is your responsibility to ensure that your application meets with your specifications. MICROCHIP MAKES NO REPRESENTATIONS OR WARRANTIES OF ANY KIND WHETHER EXPRESS OR IMPLIED, WRITTEN OR ORAL, STATUTORY OR OTHERWISE, RELATED TO THE INFORMATION, INCLUDING BUT NOT LIMITED TO ITS CONDITION, QUALITY, PERFORMANCE, MERCHANTABILITY OR FITNESS FOR PURPOSE. Microchip disclaims all liability arising from this information and its use. Use of Microchip devices in life support and/or safety applications is entirely at the buyer's risk, and the buyer agrees to defend, indemnify and hold harmless Microchip from any and all damages, claims, suits, or expenses resulting from such use. No licenses are conveyed, implicitly or otherwise, under any Microchip intellectual property rights.

**Trademarks**

The Microchip name and logo, the Microchip logo, Accuron, dsPIC, KEELOQ, microID, MPLAB, PIC, PICmicro, PICSTART, PRO MATE, PowerSmart, rfPIC and SmartShunt are registered trademarks of Microchip Technology Incorporated in the U.S.A. and other countries.

AmpLab, FilterLab, Migratable Memory, MXDEV, MXLAB, SEEVAL, SmartSensor and The Embedded Control Solutions Company are registered trademarks of Microchip Technology Incorporated in the U.S.A.

Analog-for-the-Digital Age, Application Maestro, CodeGuard, dsPICDEM, dsPICDEM.net, dsPICworks, ECAN, ECONOMONITOR, FanSense, FlexROM, fuzzyLAB, In-Circuit Serial Programming, ICSP, ICEPIC, Linear Active Thermistor, Mindi, MiWi, MPASM, MPLIB, MPLINK, PICKIT, PICDEM, PICDEM.net, PICLAB, PICTail, PowerCal, PowerInfo, PowerMate, PowerTool, REAL ICE, rFLAB, rfPICDEM, Select Mode, Smart Serial, SmartTel, Total Endurance, UNI/O, WiperLock and ZENA are trademarks of Microchip Technology Incorporated in the U.S.A. and other countries.

SQTP is a service mark of Microchip Technology Incorporated in the U.S.A.

All other trademarks mentioned herein are property of their respective companies.

© 2006, Microchip Technology Incorporated, Printed in the U.S.A., All Rights Reserved.

 Printed on recycled paper.

**QUALITY MANAGEMENT SYSTEM**  
**CERTIFIED BY DNV**  
**== ISO/TS 16949:2002 ==**

*Microchip received ISO/TS-16949:2002 certification for its worldwide headquarters, design and wafer fabrication facilities in Chandler and Tempe, Arizona, Gresham, Oregon and Mountain View, California. The Company's quality system processes and procedures are for its PICmicro® 8-bit MCUs, KEELOQ® code hopping devices, Serial EEPROMs, microperipherals, nonvolatile memory and analog products. In addition, Microchip's quality system for the design and manufacture of development systems is ISO 9001:2000 certified.*



# MCP7382X EVALUATION KIT USER'S GUIDE

---

---

## Table of Contents

---

---

<b>Preface</b> .....	<b>1</b>
<b>Chapter 1. Product Overview</b> .....	<b>5</b>
1.1 Introduction .....	5
1.2 What the MCP7382X Evaluation Kit Is .....	5
1.3 MCP7382X Evaluation Kit Components .....	5
<b>Chapter 2. Installation and Operation</b> .....	<b>7</b>
2.1 Description .....	7
2.2 Features .....	7
2.3 Getting Started .....	8
2.4 Detailed Description .....	9
<b>Appendix A. Schematic and Board Layouts</b> .....	<b>11</b>
A.1 Introduction .....	11
A.2 Highlights .....	11
A.3 Board Schematic .....	12
A.4 Board Layout - Top Assembly .....	13
A.5 Board Layout - Top Layer .....	14
A.6 Board Layout - Bottom Layer .....	15
<b>Appendix B. Bill Of Materials (BOM)</b> .....	<b>17</b>
<b>Worldwide Sales and Service</b> .....	<b>18</b>

# MCP7382X Evaluation Kit User's Guide

---

NOTES:



# MCP7382X EVALUATION KIT USER'S GUIDE

---

---

## Preface

---

---

### NOTICE TO CUSTOMERS

All documentation becomes dated, and this manual is no exception. Microchip tools and documentation are constantly evolving to meet customer needs, so some actual dialogs and/or tool descriptions may differ from those in this document. Please refer to our web site ([www.microchip.com](http://www.microchip.com)) to obtain the latest documentation available.

Documents are identified with a “DS” number. This number is located on the bottom of each page, in front of the page number. The numbering convention for the DS number is “DSXXXXA”, where “XXXX” is the document number and “A” is the revision level of the document.

## INTRODUCTION

This chapter contains general information that will be useful to know before using the MCP7382X Evaluation Kit. Items discussed in this chapter include:

- Document Layout
- Conventions Used in this Guide
- Recommended Reading
- The Microchip Web Site
- Customer Support
- Document Revision History

## DOCUMENT LAYOUT

This document describes how to use the MCP7382X Evaluation Kit as a development tool. The manual layout is as follows:

- **Chapter 1. “Product Overview”** – Important information on how to use the MCP7382X Evaluation Board.
- **Chapter 2. “Installation and Operation”** – For users evaluating the MCP73826, MCP73827, or MCP73828 devices, this chapter describes how to use the various features of the hardware.
- **Appendix A. “Schematic and Board Layouts”** – shows the schematic and layout diagrams for the MCP7382X Evaluation Kit.
- **Appendix B. “Bill Of Materials (BOM)”** – lists the parts used to build the MCP7382X Evaluation Kit.

# MCP7382X Evaluation Kit User's Guide

## CONVENTIONS USED IN THIS GUIDE

This manual uses the following documentation conventions:

### DOCUMENTATION CONVENTIONS

Description	Represents	Examples
<b>Arial font:</b>		
Italic characters	Referenced books	<i>MPLAB<sup>®</sup> IDE User's Guide</i>
	Emphasized text	...is the <i>only</i> compiler...
Initial caps	A window	the Output window
	A dialog	the Settings dialog
	A menu selection	select Enable Programmer
Quotes	A field name in a window or dialog	"Save project before build"
Underlined, italic text with right angle bracket	A menu path	<u><i>File&gt;Save</i></u>
Bold characters	A dialog button	Click <b>OK</b>
	A tab	Click the <b>Power</b> tab
N'Rnnnn	A number in verilog format, where N is the total number of digits, R is the radix and n is a digit.	4'b0010, 2'hF1
Text in angle brackets < >	A key on the keyboard	Press <Enter>, <F1>
<b>Courier New font:</b>		
Plain Courier New	Sample source code	#define START
	Filenames	autoexec.bat
	File paths	c:\mcc18\h
	Keywords	_asm, _endasm, static
	Command-line options	-Opa+, -Opa-
	Bit values	0, 1
	Constants	0xFF, 'A'
Italic Courier New	A variable argument	<i>file.o</i> , where <i>file</i> can be any valid filename
Square brackets [ ]	Optional arguments	mcc18 [options] <i>file</i> [options]
Curly brackets and pipe character: {   }	Choice of mutually exclusive arguments; an OR selection	errorlevel {0 1}

## RECOMMENDED READING

This user's guide describes how to use MCP7382X Evaluation Kit. For more information regarding the MCP7382X devices, the following are recommended reading.

### MCP7382X Data Sheets

These data sheets provide detailed information regarding the MCP7382X Single Cell Lithium-Ion Charge Management Controllers:

- MCP73826 Data Sheet (DS21705)
- MCP73827 Data Sheet (DS21704)
- MCP73828 Data Sheet (DS21706)

## THE MICROCHIP WEB SITE

Microchip provides online support via our web site at [www.microchip.com](http://www.microchip.com). This web site is used as a means to make files and information easily available to customers. Accessible by using your favorite Internet browser, the web site contains the following information:

- **Product Support** – Data sheets and errata, application notes and sample programs, design resources, user's guides and hardware support documents, latest software releases and archived software
- **General Technical Support** – Frequently Asked Questions (FAQs), technical support requests, online discussion groups, Microchip consultant program member listing
- **Business of Microchip** – Product selector and ordering guides, latest Microchip press releases, listing of seminars and events, listings of Microchip sales offices, distributors and factory representatives

## CUSTOMER SUPPORT

Users of Microchip products can receive assistance through several channels:

- Distributor or Representative
- Local Sales Office
- Field Application Engineer (FAE)
- Technical Support
- Development Systems Information Line

Customers should contact their distributor, representative or field application engineer for support. Local sales offices are also available to help customers. A listing of sales offices and locations is included in the back of this document.

Technical support is available through the web site at: <http://support.microchip.com>

## DOCUMENT REVISION HISTORY

### Revision B (July 2006)

- Add disclaimer to Bill of Materials regarding RoHS-Compliant part numbers.

### Revision A (January 2002)

- Initial Release of this Document.

# MCP7382X Evaluation Kit User's Guide

---

NOTES:





# MCP7382X EVALUATION KIT USER'S GUIDE

---

---

## Chapter 1. Product Overview

---

---

### 1.1 INTRODUCTION

This chapter provides an overview of the MCP7382X Evaluation Kit, and instructions on how to connect the system components.

This chapter covers the following topics:

- What the MCP7382X Evaluation Kit Is
- MCP7382X Evaluation Kit Components

### 1.2 WHAT THE MCP7382X EVALUATION KIT IS

The MCP7382X Evaluation Kit is an evaluation and demonstration tool for Microchip Technology's MCP7382X Single Cell Lithium-Ion Charge Management Controllers. The design provides for dynamic versatility while being able to handle accurate measurements.

When connected, this evaluation board allows for the evaluation of the MCP7382X devices in a variety of applications.

### 1.3 MCP7382X EVALUATION KIT COMPONENTS

The MCP7382X Evaluation Kit contains:

- MCP7382X Evaluation Board (102-00017)
- MCP73826-4.2VCH, MCP73827-4.2VUA, and MCP73828-4.2VUA Devices installed
- Analog and Interface Products Demonstration Boards CD-ROM (DS21912)
  - MCP7382X Evaluation Kit User's Guide

# MCP7382X Evaluation Kit User's Guide

---

NOTES:



# MCP7382X EVALUATION KIT USER'S GUIDE

---

---

## Chapter 2. Installation and Operation

---

---

### 2.1 DESCRIPTION

The MCP7382X Evaluation Kit is an evaluation kit designed to support Microchip's MCP73826, MCP73827, and MCP73828 single-cell Li-Ion charge management devices. The evaluation kit is fully assembled and tested. The kit is useful for evaluating simple stand-alone operation or for evaluating applications interfaced with a microcontroller.

### 2.2 FEATURES

The MCP7382X Evaluation Board has the following features:

- Evaluation of MCP73827/28 in 8-pin MSOP packages
- Evaluation of MCP73826 in 6-pin SOT-23 package
- Simple Stand-Alone Operation or Microcontroller Compatible
- Powered from external bench supply or voltage regulated wall cube
- Surface-Mount Design
- Fully Assembled and Tested

# MCP7382X Evaluation Kit User's Guide

## 2.3 GETTING STARTED

The MCP7382X Evaluation Board is a fully functional, assembled, and tested surface mount board for evaluation of Microchip's MCP73826/27/28 single-cell Li-Ion battery charger devices. The following steps provide simple stand-alone operation. Refer to the set-up configuration diagram below. Note: Do not turn on the input power until all other set-up steps are complete.

1. Place a jumper on JP4 to select the appropriate device for evaluation.
2. Place a jumper on JP5 to enable the appropriate device for evaluation.
3. Connect an external bench supply or voltage regulated wall cube to JP1.  
**Observe correct polarity of connection.**
4. Connect a single cell Li-Ion battery pack to JP2. **Observe correct polarity of connection.**
5. For MCP73828 evaluation, connect external battery pack thermistor to JP3.
6. Turn-on bench supply or plug-in wall cube.
7. For MCP73827 evaluation, LED D3 shall be turned off when the charge cycle transitions from controlled current mode to constant voltage mode charge.
8. For MCP73828 evaluation, LED D2 shall illuminate when the battery pack is at full charge.

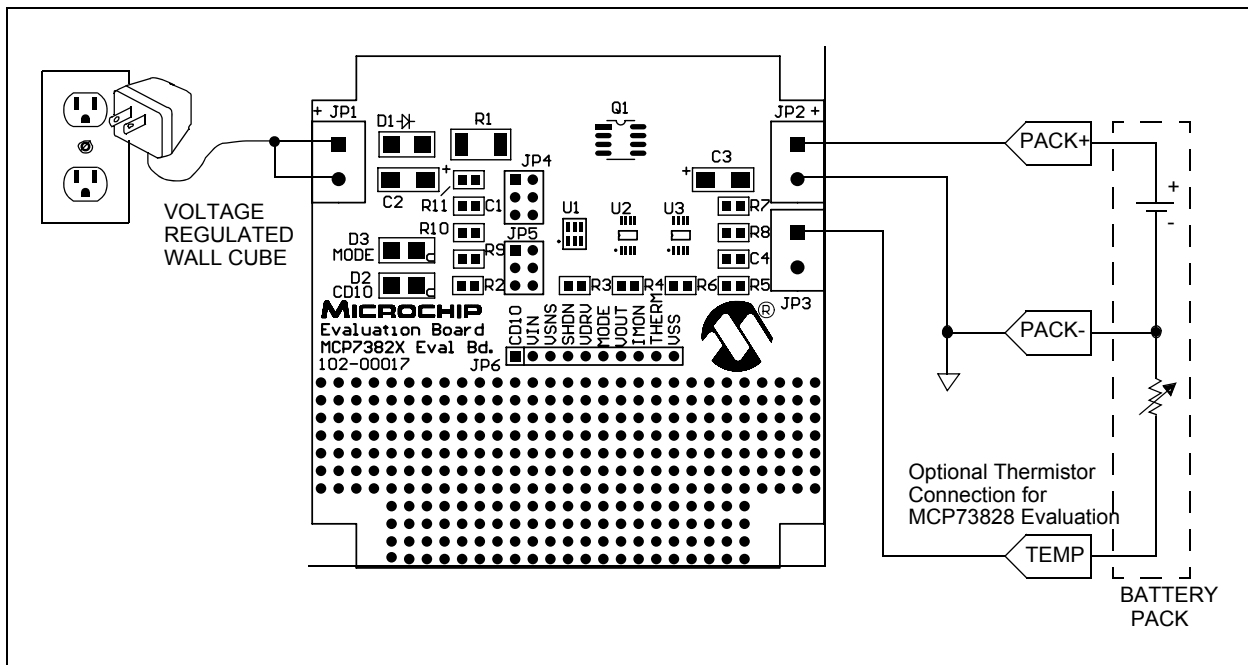

FIGURE 2-1: Set-Up Configuration Diagram

## 2.4 DETAILED DESCRIPTION

The MCP7382X Evaluation Board is set-up to evaluate simple, stand-alone, linear charging of single cell Li-Ion battery packs. Each of the three Li-Ion battery chargers can be evaluated independently. The chargers provide controlled current charging followed by constant voltage charging. The MCP73826, U1, is provided in a 6-pin SOT23 package and is equipped with shutdown control. The MCP73827, U2, is provided in an 8-pin MSOP package. In addition to shutdown control, the MCP73827 signals when the charge cycle transitions from controlled current mode to constant voltage mode. An LED, D3, is illuminated during the controlled current mode. A voltage representation of the charge current,  $I_{MON}$ , is provided for a host microcontroller to monitor the charge profile. The MCP73828, U3, is also provided in an 8-pin MSOP package. In addition to shutdown control, the MCP73828 signals when the charge current has diminished below ten percent of the peak charge current. An LED, D2, is illuminated indicating full charge. A thermistor input is provided to inhibit charging when the cell temperature is outside a pre-defined window. Refer to the appropriate data sheets for details on the individual device features.

### 2.4.1 Input Source

The MCP7382X Evaluation Board is designed to provide an output current of 1A, typical. A 5V  $\pm$ 10%, 6W input source should be utilized to power the evaluation kit. JP1 terminal 1 is the positive input source connection. JP1 terminal 2 is the negative input source connection.

Higher or lower output currents can be obtained by adjusting the value of the sense resistor, R1. A corresponding higher or lower power input source may need to be utilized. Care should be taken not to over stress the pass transistor, Q1, with excessive power dissipation when higher output currents are desired.

### 2.4.2 Reverse Blocking Protection

The MCP7382X Evaluation Board is designed to provide reverse blocking protection in the event a reversed polarity input source is connected to JP1. The reverse blocking protection diode, D1, also ensures that a faulted or shorted input source will not adversely effect the battery pack.

### 2.4.3 Battery Headers

Two headers, JP2 and JP3 are used to connect to an external Li-Ion battery pack and optional protection thermistor. JP2 terminal 1 is the battery pack positive connection, JP2 terminal 2 is the negative battery pack connection. JP3 terminal 1 is for connection to a 10 k ohm NTC thermistor situated in the battery pack for temperature sensing. JP3 terminal 2 is the negative reference for the thermistor.

**Note:** Improper connection of the battery may result in damage to the battery and the possibility of personal injury. It is also important to avoid shorting the battery terminals together.

# MCP7382X Evaluation Kit User's Guide

## 2.4.4 Device Support Options

The MCP7382X Evaluation Board provides evaluation of three Li-Ion battery chargers: MCP73826, MCP73827, or MCP73828. Device selection is performed by placing shunts on JP4 and JP5 as indicated in the table below. JP4 determines which device is controlling the pass transistor. JP5 is used to enable the appropriate device.

TABLE 2-1: SHUNT JUMPERS

Device Type	JP4 Shunt Location	JP5 Shunt Location
MCP73826	5, 6	1, 2
MCP73827	3, 4	3, 4
MCP73828	1, 2	5, 6

## 2.4.5 Microcontroller Option

JP6 provides an easily accessible location for interface to a host microcontroller. The host microcontroller can be used to disable the charger, monitor charge status, monitor the charge profile, or terminate a charge.

A proto-typing area is provided for generation of a self-contained microcontroller solution.

## 2.4.6 Output Voltage Options

The MCP7382X Evaluation Board is provided with a constant voltage mode output voltage of 4.2V. Evaluation with a constant voltage mode output voltage of 4.1V can be achieved by replacing U1, U2, or U3 with the appropriate device. Refer to the appropriate data sheets for device ordering information.

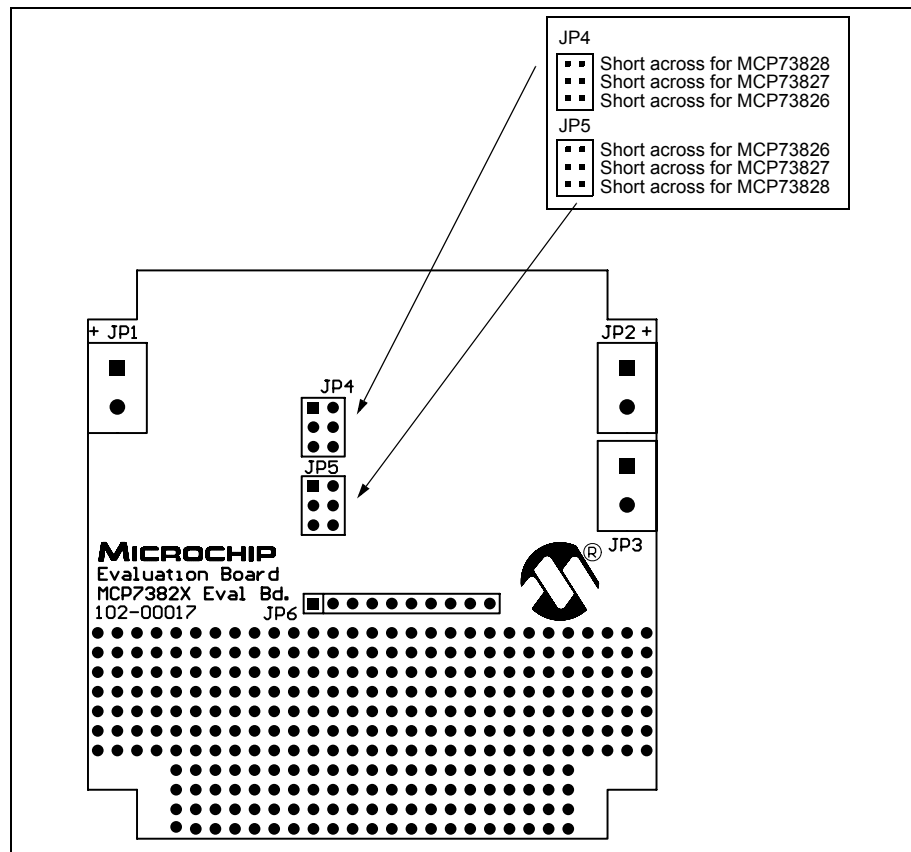

FIGURE 2-2: Jumper Locations on the MCP7382X Evaluation Board.



# MCP7382X EVALUATION KIT USER'S GUIDE

---

---

## Appendix A. Schematic and Board Layouts

---

---

### A.1 INTRODUCTION

This appendix contains the schematic and board layouts for the MCP7382X Evaluation Kit.

### A.2 HIGHLIGHTS

Diagrams included in this appendix:

- Board Schematic
- Board Layout - Top Assembly
- Board Layout - Top Layer
- Board Layout - Bottom Layer

# MCP7382X Evaluation Kit User's Guide

## A.3 BOARD SCHEMATIC

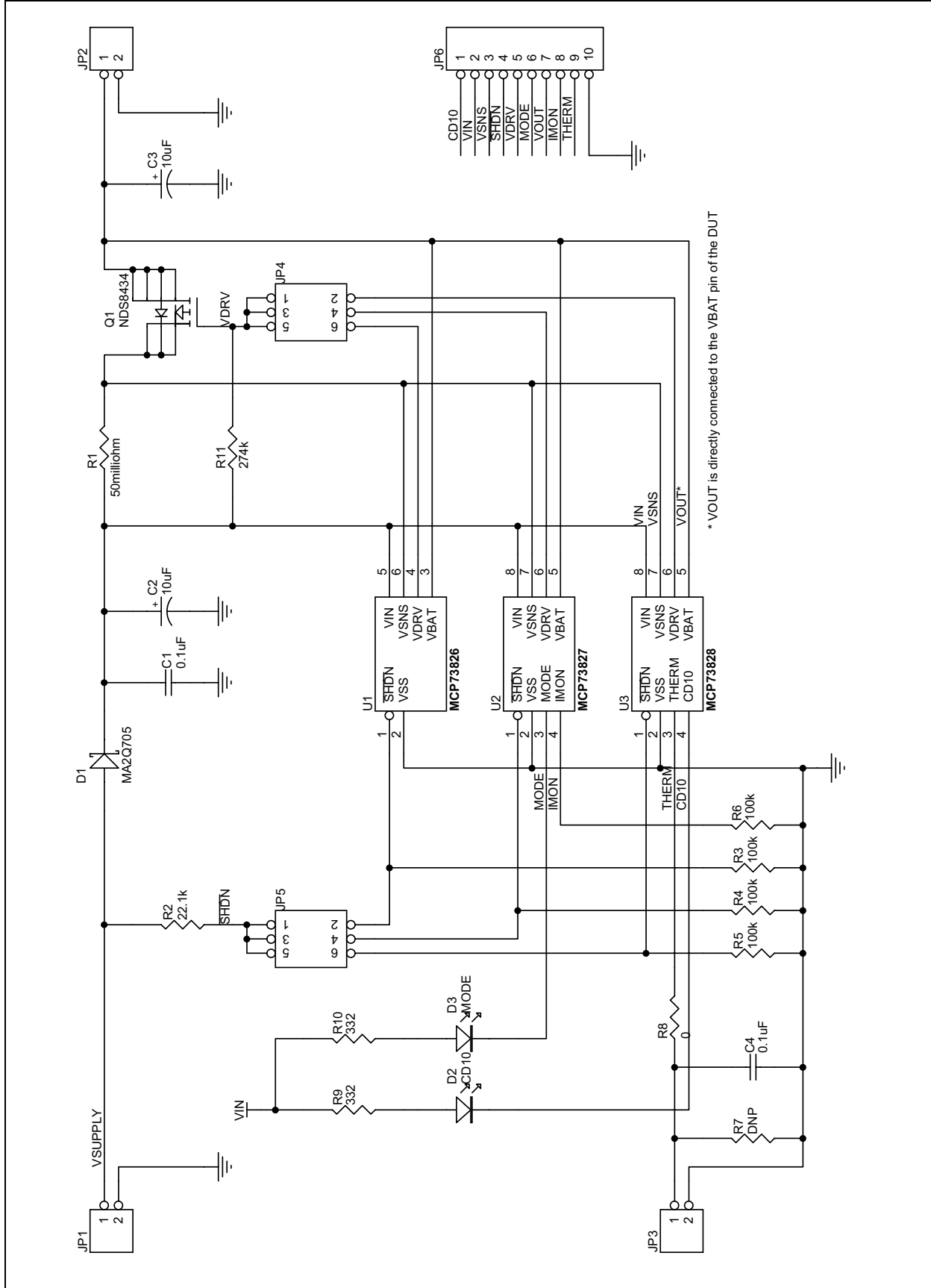



## A.4 BOARD LAYOUT - TOP ASSEMBLY

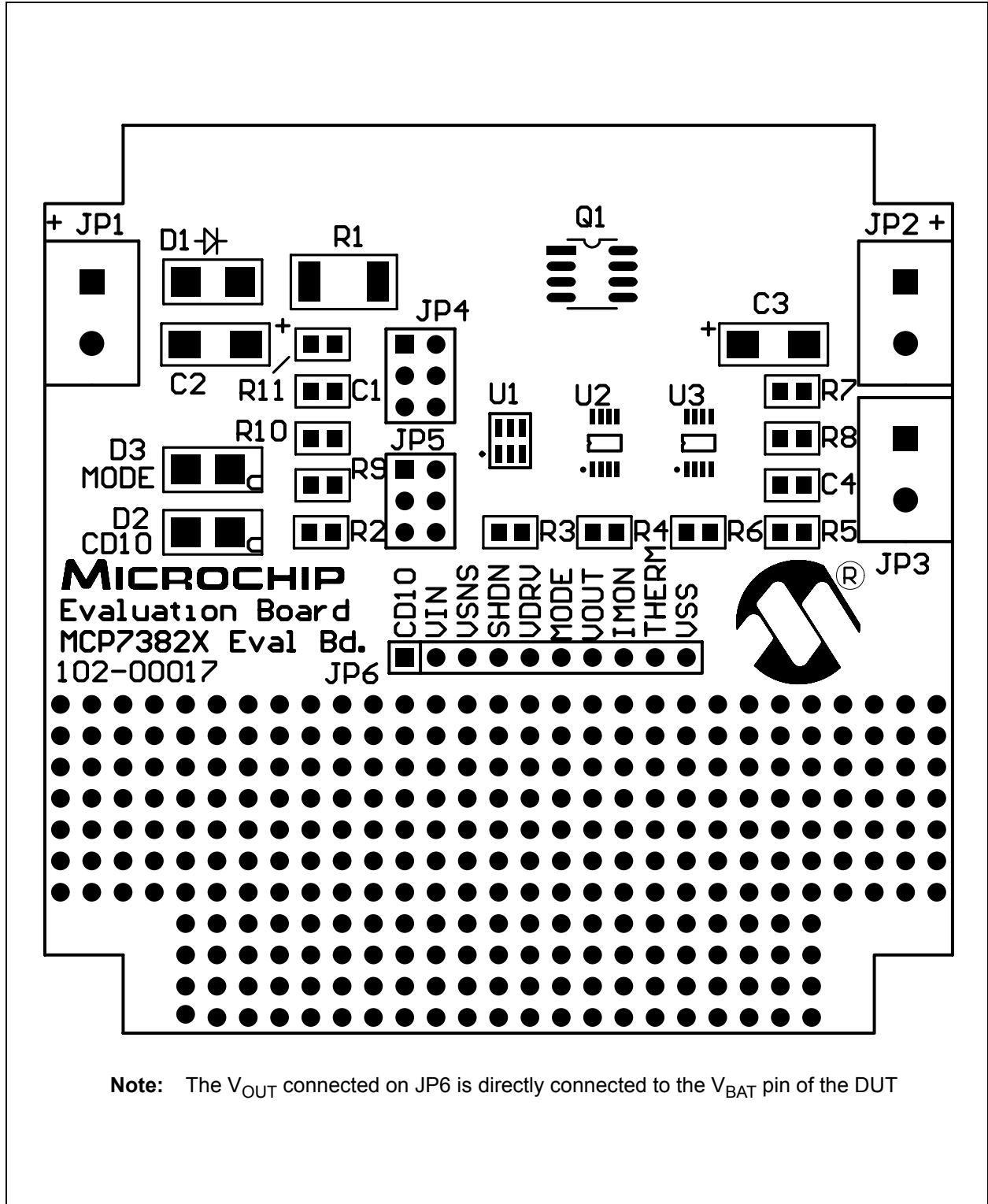

# MCP7382X Evaluation Kit User's Guide

## A.5 BOARD LAYOUT - TOP LAYER

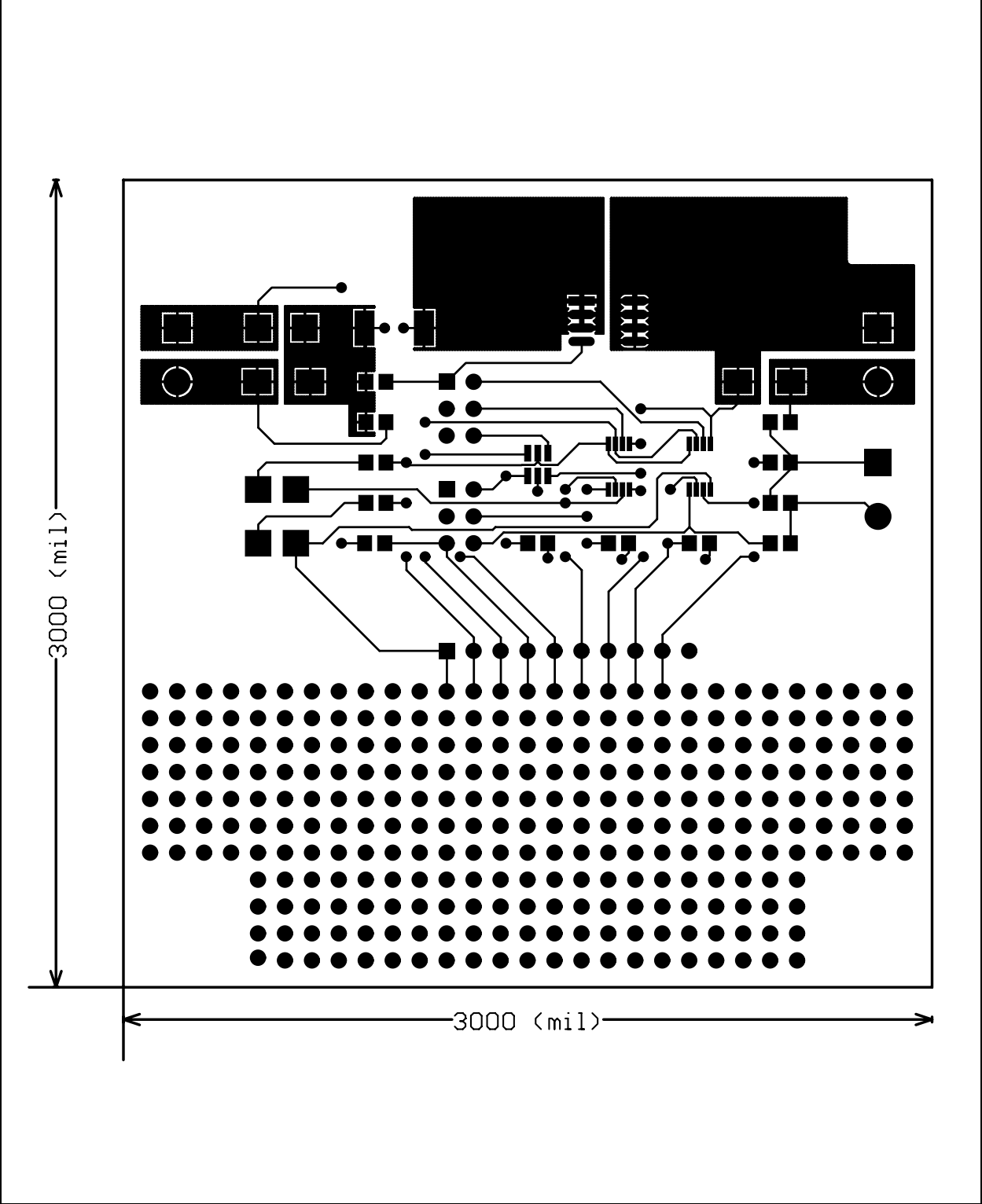

## A.6 BOARD LAYOUT - BOTTOM LAYER

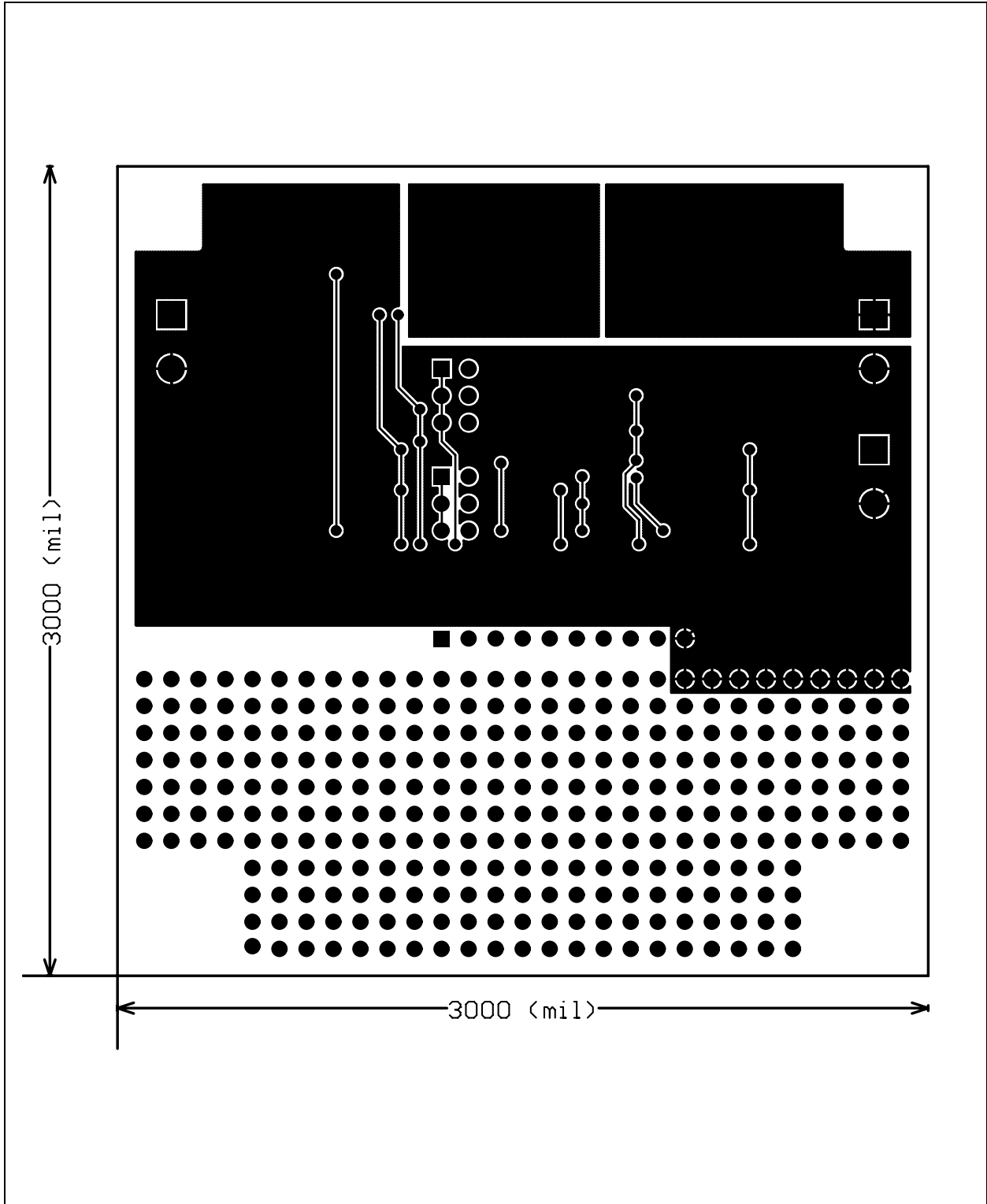

# MCP7382X Evaluation Kit User's Guide

---

NOTES:

**Appendix B. Bill Of Materials (BOM)**

**TABLE B-1: BILL OF MATERIALS (BOM)**

Qty	Reference	Description	Manufacturer	Part Number
2	C1, C4	0.1 $\mu$ F, 25V, Y5U Ceramic, 0805	Panasonic	ECJ-2VF1E104Z
2	C2, C3	10 $\mu$ F, 25V, Tantalum, SMC, Input/Output	Panasonic	ECS-T1EC106R
1	D1	1.5 A Shottky Diode, Reverse Protection	Panasonic	MA2Q705
2	D2, D3	Red LED, Surface Mount	Lumex	SML-LX2832GC
3	JP1, JP2, JP3	Screw Header	Weidmuller	171602
1	JP4, JP5	Dual In-Line Header, "0.100, 3x2 Position	Sullins	PTC36DAAN <sup>(1)</sup>
1	JP6	Single In-Line Header, "0.100, 10x1 Position	Sullins	PTC36SYAN <sup>(2)</sup>
1	Q1	P-channel MOSFET, SOIC8	Fairchild	NDS8434
1	R1	50 milliohm sense resistor	Panasonic	ERJ-L1WKF50MU
1	R2	22.1 kohm, 1/10W, 1%, Thick Film Chip, 0805	Panasonic	ERJ-6ENF2212V
4	R3, R4, R5, R6	22.1 kohm, 1/10W, 1%, Thick Film Chip, 0805	Panasonic	ERJ-6ENF2212V
0	R7	Not populated, 0805		
1	R8	0.0 ohm Jumper, 0805	Phycomp	9C08052A0R00JLH
2	R9, R10	332 ohm, 1/10W, 1%, Thick Film Chip, 0805	Panasonic	ERJ-6ENF3320V
1	R11	274 kohm, 1/10W, 1%, Thick Film Chip, 0805	Panasonic	ERJ-6ENF2743V
1	U1	Lithium-Ion Battery Charger, SOT23-6	Microchip	MCP73826-4.2VCH
1	U2	Lithium-Ion Battery Charger, MSOP8	Microchip	MCP73827-4.2VUA
1	U3	Lithium-Ion Battery Charger, MSOP8	Microchip	MCP73828-4.2VUA
2	—	Header Shunts	Sullins	STC02STAN
4	—	Bumpons - Protective Products	3M	SJ5003-0

**Note 1:** JP4, JP5 are ordered as a 36x2 strip header. Cut to fit. One for every 5 boards built.

**Note 2:** JP6 is ordered as a 36x1 strip header. Cut to fit. One for every 3 boards built.

**Note 3:** The components listed in this Bill of Materials are representative of the PCB assembly. The released BOM used in manufacturing uses all RoHS-compliant components.