

DESCRIPTION

The MCS1802 is a linear Hall-effect current sensor for AC or DC current sensing. The Hall array is differential, which cancels out any stray magnetic field.

A primary conductor with a low resistance allows current to flow close to the IC, which contains high-accuracy Hall-effect sensors. This current generates a magnetic field that is sensed at two different points by the integrated Hall-effect transducers. The magnetic field difference between these two points is then converted into a voltage that is proportional to the applied current. A spinning current technique is used for a low and stable offset.

The galvanic isolation between the pins of the primary conductive path and the sensor leads allows the MCS1802 to replace opto-isolators or other isolation devices.

The MCS1802 requires a minimal number of readily available, standard external components. The device's small footprint saves board area and makes it well-suited for space-constrained applications. The MCS1802 is available in an SOIC-8 package.

FEATURES

- 3.3V Single Supply
- Immune to External Magnetic Fields by Differential Sensing
- 2.2kV_{RMS} Minimum Isolation Voltage
- Operating Temperature: -40°C to +125°C
- 0.9mΩ Internal Conductor Resistance
- $\pm 5A$ to $\pm 50A$ Bi-directional Range
- Adjustable Bandwidth up to 100kHz
- 4μs Output Rising Time
- Ratiometric Output from Supply Voltage
- Output Proportional to AC or DC Currents
- Factory-Trimmed for Accuracy
- No Magnetic Hysteresis
- Available in an SOIC-8 Package



CB Certificate Number:
CA-11398-UL

APPLICATIONS

- Motor Control
- Automotive Systems
- Load Detection and Management
- Switch-Mode Power Supplies
- Over-Current Fault Protection

All MPS parts are lead-free, halogen-free, and adhere to the RoHS directive. For MPS green status, please visit the MPS website under Quality Assurance. "MPS", the MPS logo, and "Simple, Easy Solutions" are trademarks of Monolithic Power Systems, Inc. or its subsidiaries.

TYPICAL APPLICATION

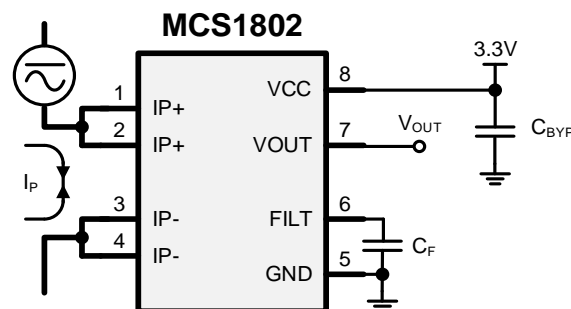

Note:

1) V_{OUT} is proportional to I_P within the specified range. The noise vs. bandwidth tradeoff can be adjusted by connecting a capacitor (C_F) between FILT and GND.

ORDERING INFORMATION

Part Number*	Optimized Primary Current Range (A)	Typ Sensitivity (SENS)(mV/A)	Top Marking	MSL Rating
MCS1802GS-05	±5	264	MC180205	1
MCS1802GS-10	±10	132	MC180210	
MCS1802GS-20	±20	66	MC180220	
MCS1802GS-30	±30	44	MC180230	
MCS1802GS-40	±40	33	MC180240	
MCS1802GS-50	±50	26.4	MC180250	

* For Tape & Reel, add suffix -Z (e.g. MCS1802GS-05-Z).

TOP MARKING (MCS1802GS-05)

MC180205
LLLLLLLLL
MPSYWW

MC180205: Part number
 LLLLLLLL: Lot number
 MPS: MPS prefix
 Y: Year code
 WW: Week code

TOP MARKING (MCS1802GS-10)

MC180210
LLLLLLLLL
MPSYWW

MC180210: Part number
 LLLLLLLL: Lot number
 MPS: MPS prefix
 Y: Year code
 WW: Week code

TOP MARKING (MCS1802GS-20)

MC180220
LLLLLLLL
MPSYWW

MC180220: Part number
LLLLLLLL: Lot number
MPS: MPS prefix
Y: Year code
WW: Week code

TOP MARKING (MCS1802GS-30)

MC180230
LLLLLLLL
MPSYWW

MC180230: Part number
LLLLLLLL: Lot number
MPS: MPS prefix
Y: Year code
WW: Week code

TOP MARKING (MCS1802GS-40)

MC180240
LLLLLLLL
MPSYWW

MC180240: Part number
LLLLLLLL: Lot number
MPS: MPS prefix
Y: Year code
WW: Week code

TOP MARKING (MCS1802GS-50)

MC180250

LLLLLLLL

MPSYWW

MC180250: Part number

LLLLLLLL: Lot number

MPS: MPS prefix

Y: Year code

WW: Week code

PACKAGE REFERENCE

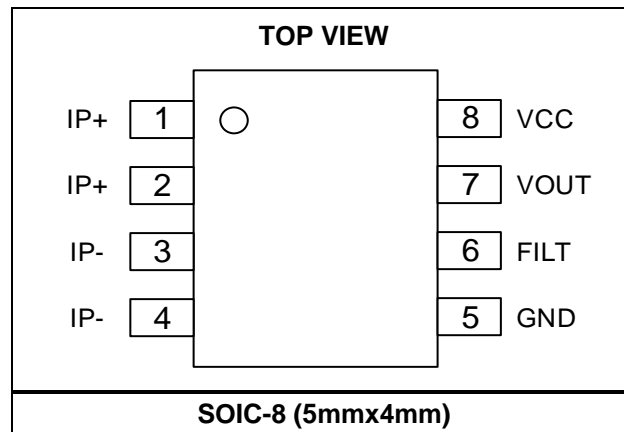

PIN FUNCTIONS

Pin #	Name	Description
1, 2	IP+	Primary current (+). IP+ is a terminal for the current being sampled. These pins are internally connected together.
3, 4	IP-	Primary current (-). IP- is a terminal for the current being sampled. These pins are internally connected together.
5	GND	Ground. Signal ground terminal.
6	FILT	Filter. FILT is a terminal for the external capacitor (C_F), which sets the bandwidth. FILT can be left floating when the bandwidth setting is not required.
7	VOUT	Analog output.
8	VCC	Voltage supply. Connect VCC to a 3.3V power supply. Bypass with a 1µF low ESR ceramic capacitor as close to VCC pin as possible.

ABSOLUTE MAXIMUM RATINGS ⁽²⁾

Supply voltage (V_{CC})-0.1V to +6V
Output voltage (V_{OUT})-0.1V to +6V
V_{FILT}-0.1V to +6V
Junction temperature165°C
Lead temperature260°C
Storage temperature -65°C to +165°C

ESD Ratings

Human body model (HBM) ±2kV
Charged device model (CDM) ±2kV

Recommended Operating Conditions ⁽³⁾

Supply voltage (V_{CC}) 3.0V to 3.6V
Operating junction temp (T_J)-40°C to +125°C

Notes:

- 2) Exceeding these ratings may damage the device.
- 3) The device is not guaranteed to function outside of its operating conditions.

ISOLATION CHARACTERISTICS

Parameters	Symbol	Condition	Rating	Units
Dielectric surge strength test voltage	V_{SURGE}	Test ± 5 pulses at 2/minute, $1.2\mu s$ (rise)/ $50\mu s$ (width) according to IEC61000-4-5.	6000	V
Withstand isolation voltage	V_{ISO}	Agency type-tested for 60 seconds in accordance with IEC62368-1. 100% Tested in production in accordance with IEC 62368-1.	2200	V_{RMS}
Maximum isolation working voltage	V_{IOWM}	Maximum approved working voltage for basic isolation, according to IEC62368-1.	350	V_{PK} or V_{DC}
			250	V_{RMS}
External clearance	CLR	Shortest distance through the air from the IP leads to the signal leads.	4.2	mm
External creepage	CPG	Shortest distance along the package body from the IP leads to the signal leads.	4.2	mm

WITHSTANDING CURRENT CAPABILITY

Parameters	Symbol	Condition	Rating	Units
Surge current test	I_{SURGE}	Test ± 5 pulses at 2/minute, $8\mu s$ (rise) / $20\mu s$ (width), according to IEC61000-4-5	3000	A
Transient current test ⁽⁴⁾	$I_{TRANSIENT}$	Single peak, 10ms	250	A

Note:

4) For the detailed transient current capability test, refer to MPS application note AN178, available on the MPS website.

MCS1802 COMMON ELECTRICAL CHARACTERISTICS

$V_{CC} = 3.3V$, $T_J = -40^{\circ}C$ to $+125^{\circ}C$, unless otherwise noted. Typical values at $T_J = 25^{\circ}C$.

Parameters	Symbol	Condition	Min	Typ ⁽⁵⁾	Max	Units
Supply voltage	V_{CC}		3.0		3.6	V
VCC under-voltage lockout threshold	V_{CC_UVLO}	V_{CC} rising	2	2.5	3	V
VCC under-voltage lockout hysteresis	$V_{CC_UVLO_HYS}$			400	750	mV
Operating supply current	I_{CC}	$V_{CC} = 3.3V$		8.5	10.5	mA
Output capacitance load ⁽⁹⁾	C_L	From VOUT to GND			10	nF
Output resistive load ⁽⁹⁾	R_L	From VOUT to GND	4.7			k Ω
Primary conductor resistance ⁽¹⁰⁾	R_P	Effective		0.9		m Ω
Frequency bandwidth	f_{BW}	FILT unconnected		100		kHz
Internal filter resistance	R_{Fi}			1.5		k Ω
Internal filter capacitance	C_{Fi}			1		nF
Power-on time	t_{PO}	$I_P = I_{P_{MAX}}$, FILT unconnected		90		μs
Rise time	t_R	$I_P = I_{P_{MAX}}$, FILT unconnected		4		μs
Propagation delay	t_{PD}	$I_P = I_{P_{MAX}}$, FILT unconnected		1.5		μs
Response time	$t_{RESPONSE}$	$I_P = I_{P_{MAX}}$, FILT unconnected		5		μs
Noise density	I_{ND}	Input referenced noise density		200		$\mu A_{(RMS)}/\sqrt{Hz}$
Noise	I_N	Input referred, 1nF on FILT (60kHz bandwidth)		50		$mA_{(RMS)}$
Nonlinearity	E_{LIN}	Across the full I_P range		0.5		%
Ratiometry	K_{SENS}	$V_{CC} = 3.0$ to $3.6V$	98	100	102	%
	K_{V0}	$V_{CC} = 3.0$ to $3.6V$, $I_P = 0A$	99	100	101	%
Zero current output voltage	$V_{OUT(Q)}$	$I_P = 0A$		$V_{CC} / 2$		V
First Hall magnetic coupling factor	P_{MCF1}			0.6		mT/A
Second Hall magnetic coupling factor	P_{MCF2}			0.3		mT/A
Hall plate matching	M_H			±1		%
Saturation voltage ^{(6) (9)}	$V_{OUT(H)}$	$R_L = 4.7k\Omega$, $T_J = 25^{\circ}C$	$V_{CC} - 0.3$			V
	$V_{OUT(L)}$	$R_L = 4.7k\Omega$, $T_J = 25^{\circ}C$			0.3	V

MCS1802-05 PERFORMANCE CHARACTERISTICS

$V_{CC} = 3.3V$, $T_J = -40^{\circ}C$ to $+125^{\circ}C$, unless otherwise noted.

Parameters	Symbol	Condition	Min	Typ ⁽⁵⁾	Max	Units
Optimized accuracy range ⁽⁷⁾	I_P		-5		+5	A
Sensitivity	SENS	$-5A \leq I_P \leq +5A$, $T_J = 25^{\circ}C$		264		mV/A
Sensitivity error	E_{SENS}	$I_P = 5A$, $T_J = 25^{\circ}C$ to $125^{\circ}C$	-2		+2	%
		$I_P = 5A$, $T_J = -40^{\circ}C$ to $+25^{\circ}C$		±1.5		%
Offset voltage ⁽⁸⁾	V_{OE}	$I_P = 0A$, $T_J = 25^{\circ}C$ to $125^{\circ}C$	-15		+15	mV
		$I_P = 0A$, $T_J = -40^{\circ}C$ to $+25^{\circ}C$		±5		mV
Total output error	E_{TOT}	$I_P = 5A$, $T_J = 25^{\circ}C$ to $125^{\circ}C$	-2.5		+2.5	%
		$I_P = 5A$, $T_J = -40^{\circ}C$ to $+25^{\circ}C$		±1.5		%
Sensitivity error lifetime drift	$E_{SENS(D)}$			±1		%
Total output error lifetime drift	$E_{TOT(D)}$			±1		%

MCS1802-10 PERFORMANCE CHARACTERISTICS

$V_{CC} = 3.3V$, $T_J = -40^{\circ}C$ to $+125^{\circ}C$, unless otherwise noted.

Parameters	Symbol	Condition	Min	Typ ⁽⁵⁾	Max	Units
Optimized accuracy range ⁽⁷⁾	I_P		-10		+10	A
Sensitivity	SENS	$-10A \leq I_P \leq +10A$, $T_J = 25^{\circ}C$		132		mV/A
Sensitivity error	E_{SENS}	$I_P = 10A$, $T_J = 25^{\circ}C$ to $125^{\circ}C$	-2		+2	%
		$I_P = 10A$, $T_J = -40^{\circ}C$ to $+25^{\circ}C$		±1.5		%
Offset voltage ⁽⁸⁾	V_{OE}	$I_P = 0A$, $T_J = 25^{\circ}C$ to $125^{\circ}C$	-10		+10	mV
		$I_P = 0A$, $T_J = -40^{\circ}C$ to $+25^{\circ}C$		±5		mV
Total output error	E_{TOT}	$I_P = 10A$, $T_J = 25^{\circ}C$ to $125^{\circ}C$	-2.5		+2.5	%
		$I_P = 10A$, $T_J = -40^{\circ}C$ to $+25^{\circ}C$		±1.5		%
Sensitivity error lifetime drift	$E_{SENS(D)}$			±1		%
Total output error lifetime drift	$E_{TOT(D)}$			±1		%

MCS1802-20 PERFORMANCE CHARACTERISTICS

$V_{CC} = 3.3V$, $T_J = -40^{\circ}C$ to $+125^{\circ}C$, unless otherwise noted.

Parameters	Symbol	Condition	Min	Typ ⁽⁵⁾	Max	Units
Optimized accuracy range ⁽⁷⁾	I_P		-20		+20	A
Sensitivity	SENS	$-20A \leq I_P \leq +20A$, $T_J = 25^{\circ}C$		66		mV/A
Sensitivity error	E_{SENS}	$I_P = 20A$, $T_J = 25^{\circ}C$ to $125^{\circ}C$	-2		+2	%
		$I_P = 20A$, $T_J = -40^{\circ}C$ to $+25^{\circ}C$		±1.5		%
Offset voltage ⁽⁸⁾	V_{OE}	$I_P = 0A$, $T_J = 25^{\circ}C$ to $125^{\circ}C$	-10		+10	mV
		$I_P = 0A$, $T_J = -40^{\circ}C$ to $+25^{\circ}C$		±5		mV
Total output error	E_{TOT}	$I_P = 20A$, $T_J = 25^{\circ}C$ to $125^{\circ}C$	-2.5		+2.5	%
		$I_P = 20A$, $T_J = -40^{\circ}C$ to $+25^{\circ}C$		±1.5		%
Sensitivity error lifetime drift	$E_{SENS(D)}$			±1		%
Total output error lifetime drift	$E_{TOT(D)}$			±1		%

MCS1802-30 PERFORMANCE CHARACTERISTICS

$V_{CC} = 3.3V$, $T_J = -40^{\circ}C$ to $+125^{\circ}C$, unless otherwise noted.

Parameters	Symbol	Condition	Min	Typ ⁽⁵⁾	Max	Units
Optimized accuracy range ⁽⁷⁾	I_P		-30		+30	A
Sensitivity	SENS	$-30A \leq I_P \leq +30A$, $T_J = 25^{\circ}C$		44		mV/A
Sensitivity error	E_{SENS}	$I_P = 30A$, $T_J = 25^{\circ}C$ to $125^{\circ}C$	-2		+2	%
		$I_P = 30A$, $T_J = -40^{\circ}C$ to $+25^{\circ}C$		±1.5		%
Offset voltage ⁽⁸⁾	V_{OE}	$I_P = 0A$, $T_J = 25^{\circ}C$ to $125^{\circ}C$	-10		+10	mV
		$I_P = 0A$, $T_J = -40^{\circ}C$ to $+25^{\circ}C$		±5		mV
Total output error	E_{TOT}	$I_P = 30A$, $T_J = 25^{\circ}C$ to $125^{\circ}C$	-2.5		+2.5	%
		$I_P = 30A$, $T_J = -40^{\circ}C$ to $+25^{\circ}C$		±1.5		%
Sensitivity error lifetime drift	$E_{SENS(D)}$			±1		%
Total output error lifetime drift	$E_{TOT(D)}$			±1		%

MCS1802-40 PERFORMANCE CHARACTERISTICS

$V_{CC} = 3.3V$, $T_J = -40^{\circ}C$ to $+125^{\circ}C$, unless otherwise noted.

Parameters	Symbol	Condition	Min	Typ ⁽⁵⁾	Max	Units
Optimized accuracy range ⁽⁷⁾	I_P		-40		+40	A
Sensitivity	SENS	$-40A \leq I_P \leq +40A$, $T_J = 25^{\circ}C$		33		mV/A
Sensitivity error	E_{SENS}	$I_P = 40A$, $T_J = 25^{\circ}C$ to $125^{\circ}C$	-2		+2	%
		$I_P = 40A$, $T_J = -40^{\circ}C$ to $+25^{\circ}C$		±1.5		%
Offset voltage ⁽⁸⁾	V_{OE}	$I_P = 0A$, $T_J = 25^{\circ}C$ to $125^{\circ}C$	-10		+10	mV
		$I_P = 0A$, $T_J = -40^{\circ}C$ to $+25^{\circ}C$		±5		mV
Total output error	E_{TOT}	$I_P = 40A$, $T_J = 25^{\circ}C$ to $125^{\circ}C$	-2.5		+2.5	%
		$I_P = 40A$, $T_J = -40^{\circ}C$ to $+25^{\circ}C$		±1.5		%
Sensitivity error lifetime drift	$E_{SENS(D)}$			±1		%
Total output error lifetime drift	$E_{TOT(D)}$			±1		%

MCS1802-50 PERFORMANCE CHARACTERISTICS

$V_{CC} = 3.3V$, $T_J = -40^{\circ}C$ to $+125^{\circ}C$, unless otherwise noted.

Parameters	Symbol	Condition	Min	Typ ⁽⁵⁾	Max	Units
Optimized accuracy range ⁽⁷⁾	I_P		-50		+50	A
Sensitivity	SENS	$-50A \leq I_P \leq +50A$, $T_J = 25^{\circ}C$		26.4		mV/A
Sensitivity error	E_{SENS}	$I_P = 50A$, $T_J = 25^{\circ}C$ to $125^{\circ}C$	-2		+2	%
		$I_P = 50A$, $T_J = -40^{\circ}C$ to $+25^{\circ}C$		±1.5		%
Offset voltage ⁽⁸⁾	V_{OE}	$I_P = 0A$, $T_J = 25^{\circ}C$ to $125^{\circ}C$	-10		+10	mV
		$I_P = 0A$, $T_J = -40^{\circ}C$ to $+25^{\circ}C$		±5		mV
Total output error	E_{TOT}	$I_P = 50A$, $T_J = 25^{\circ}C$ to $125^{\circ}C$	-2.5		+2.5	%
		$I_P = 50A$, $T_J = -40^{\circ}C$ to $+25^{\circ}C$		±1.5		%
Sensitivity error lifetime drift	$E_{SENS(D)}$			±1		%
Total output error lifetime drift	$E_{TOT(D)}$			±1		%

Notes:

5) Typical values denoted with the “±” sign signify ±3 sigma values.

6) Beyond the maximum specified current range (I_P), the current sensor continues to provide an analog output voltage proportional to the primary current until the device reaches the high or low saturation voltage. However, the nonlinearity increases beyond the specified range (I_P).

7) The device can operate at higher primary current levels (I_P) and ambient temperatures (T_A), as long as the maximum junction temperature (T_J (MAX)) is not exceeded.

8) The offset voltage does not incorporate any error due to the external magnetic fields.

9) Guaranteed by design and characterization.

10) The resistance is defined as the total resistance measured from a point of the lead next to the solder joint, assuming that the two I_P+ pins (and I_P- pins) have the same potential (see Figure 1). This definition corresponds to the effect resistance used to estimate the joule heating, calculated with $R \times I_P^2$.

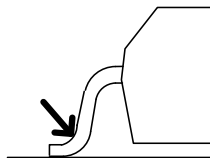
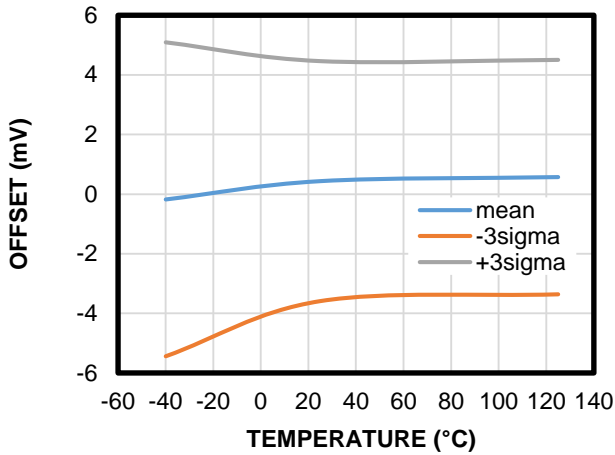

Figure 1: Total Resistance

TYPICAL CHARACTERISTICS

MCS1802GS-50, unless otherwise noted.

Offset Voltage vs. Temperature



Sensitivity vs. Temperature

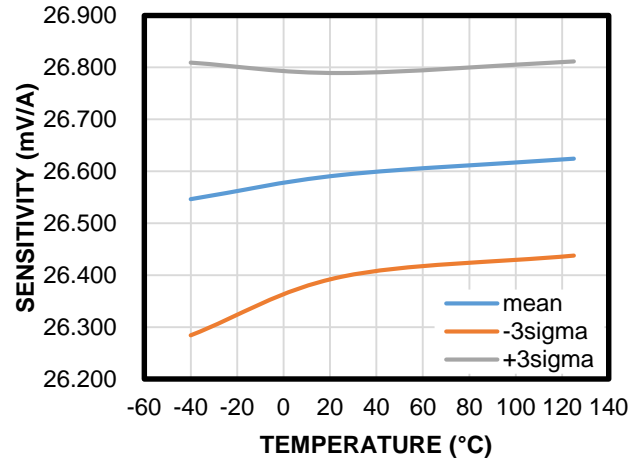

Sensitivity Error vs. Temperature

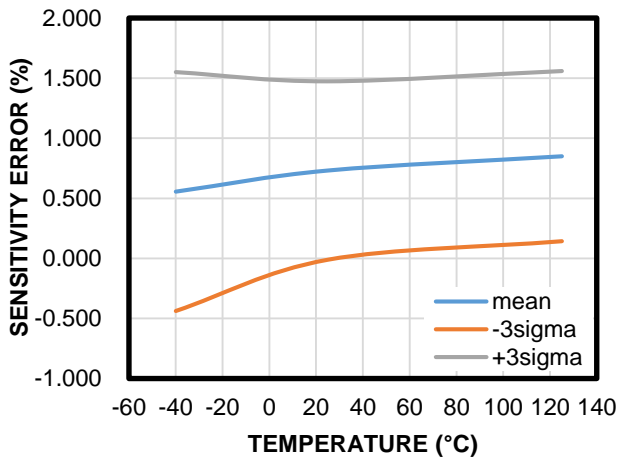

Total Error vs. Temperature

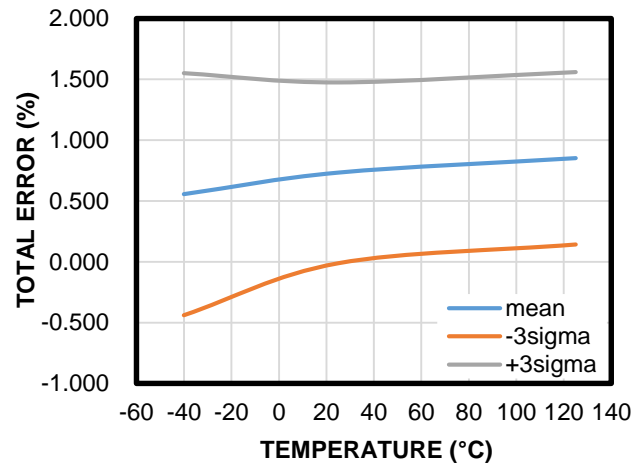

TYPICAL CHARACTERISTICS

MCS1802GS-40, unless otherwise noted.

Offset Voltage vs. Temperature

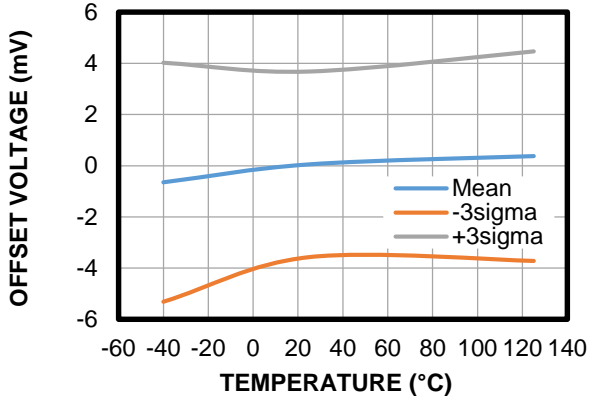

Sensitivity vs. Temperature

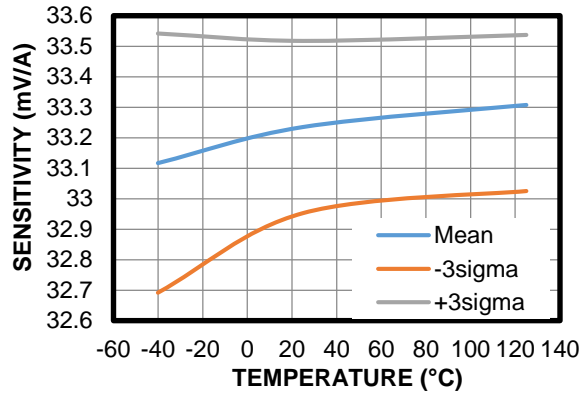

Sensitivity Error vs. Temperature

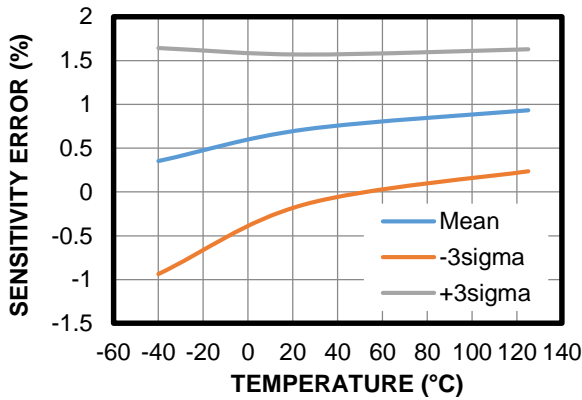

Total Error vs. Temperature

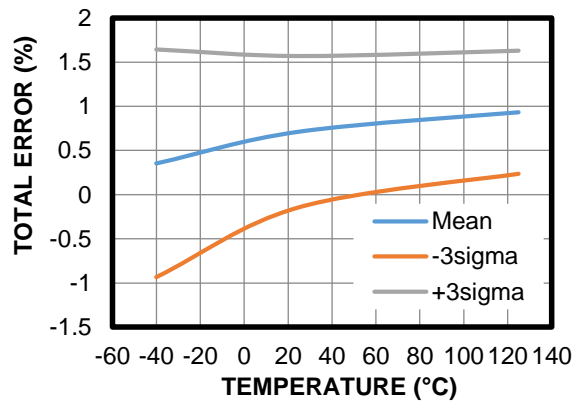

TYPICAL CHARACTERISTICS

MCS1802GS-30, unless otherwise noted.

Offset Voltage vs. Temperature

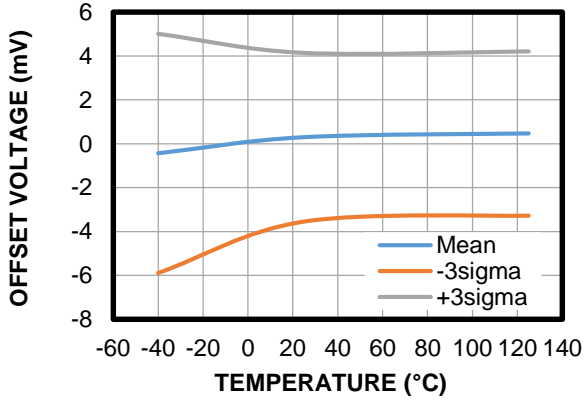

Sensitivity vs. Temperature

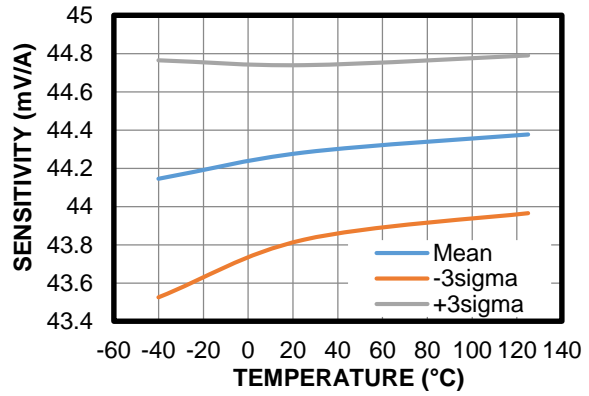

Sensitivity Error vs. Temperature

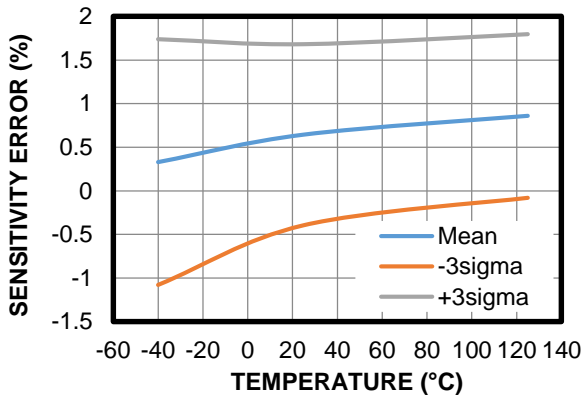

Total Error vs. Temperature

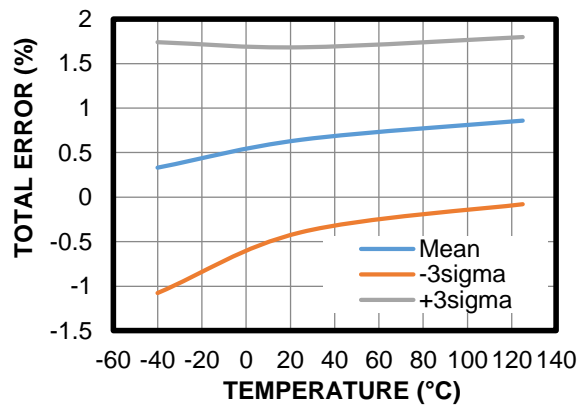

TYPICAL CHARACTERISTICS

MCS1802GS-20, unless otherwise noted.

Offset Voltage vs. Temperature

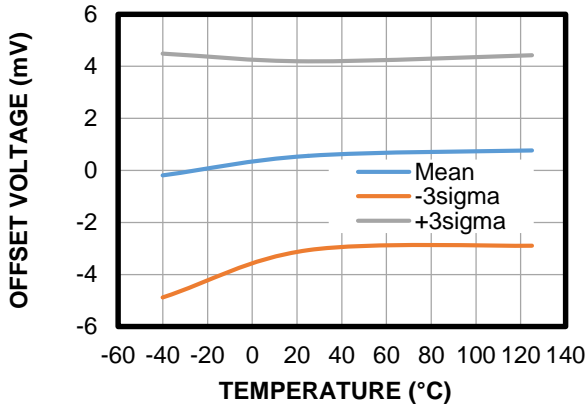

Sensitivity vs. Temperature

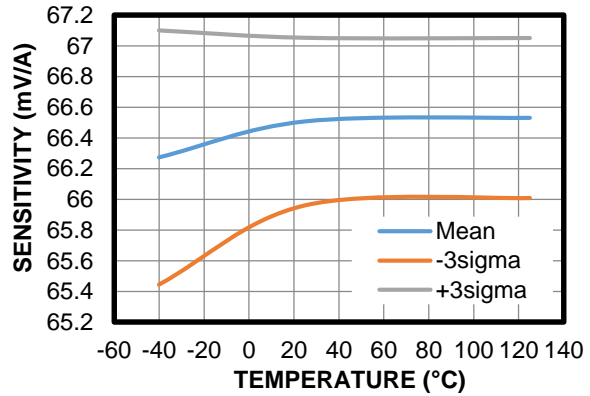

Sensitivity Error vs. Temperature

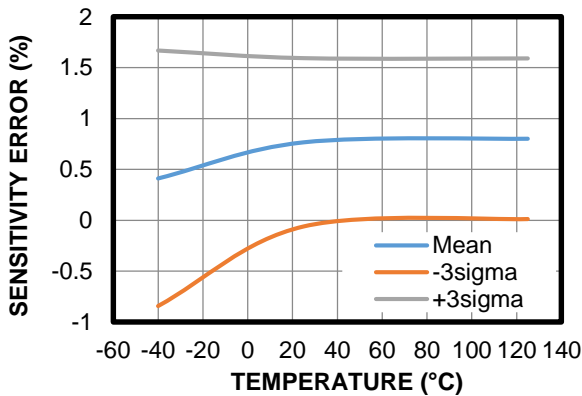

Total Error vs. Temperature

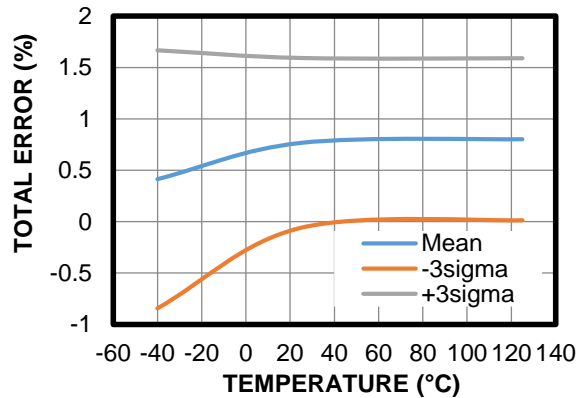

TYPICAL CHARACTERISTICS

MCS1802GS-10, unless otherwise noted.

Offset Voltage vs. Temperature

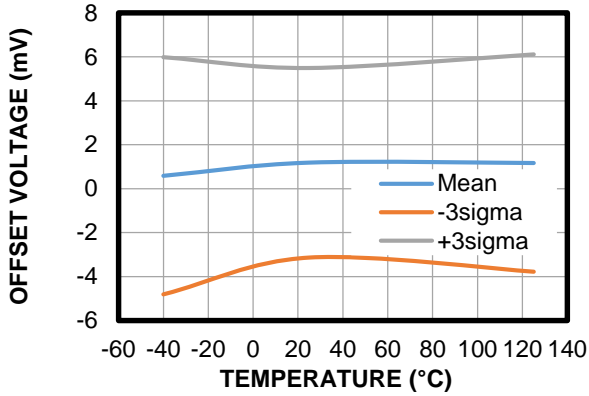

Sensitivity vs. Temperature

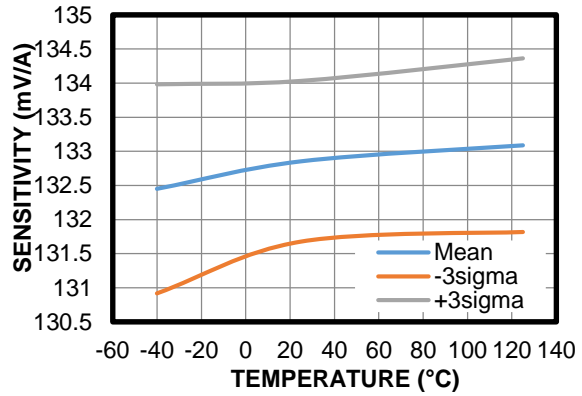

Sensitivity Error vs. Temperature

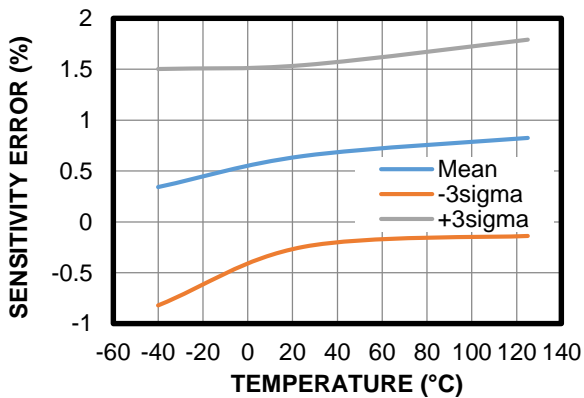

Total Error vs. Temperature

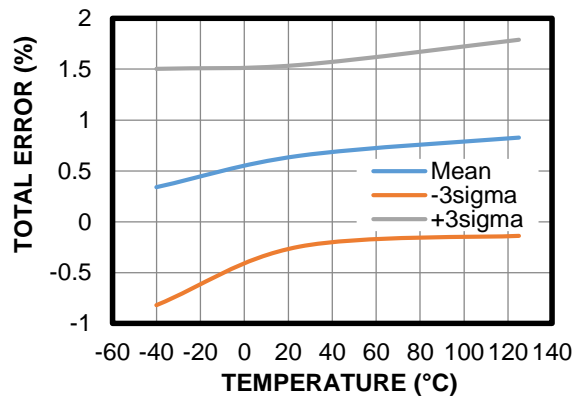

TYPICAL CHARACTERISTICS

MCS1802GS-05, unless otherwise noted.

Offset Voltage vs. Temperature

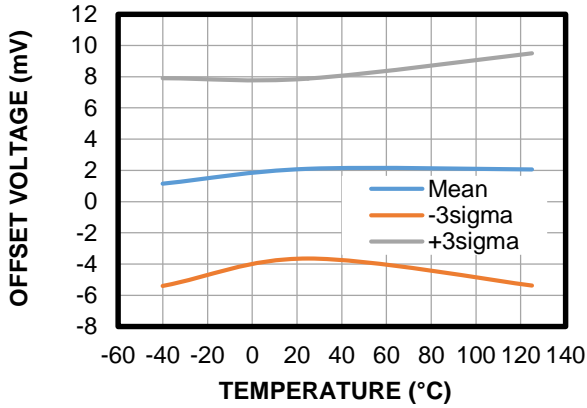

Sensitivity vs. Temperature

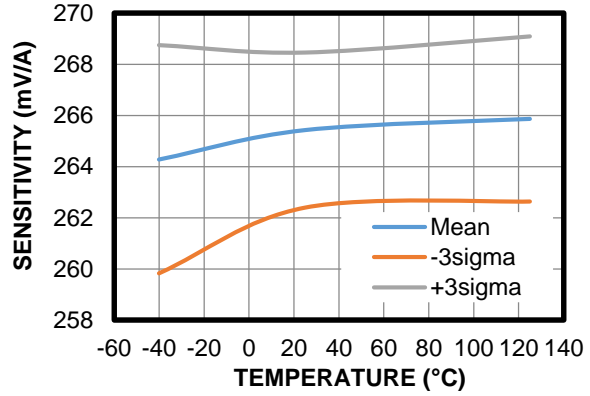

Sensitivity Error vs. Temperature

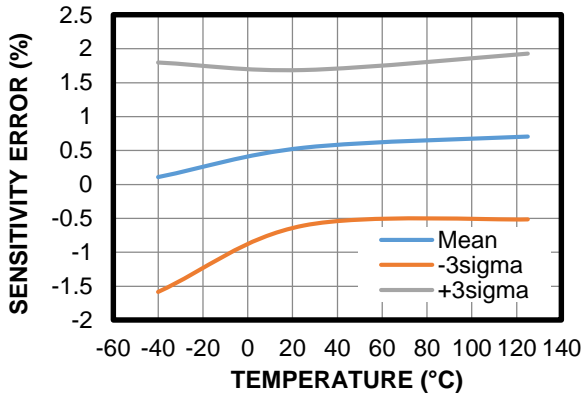

Total Error vs. Temperature

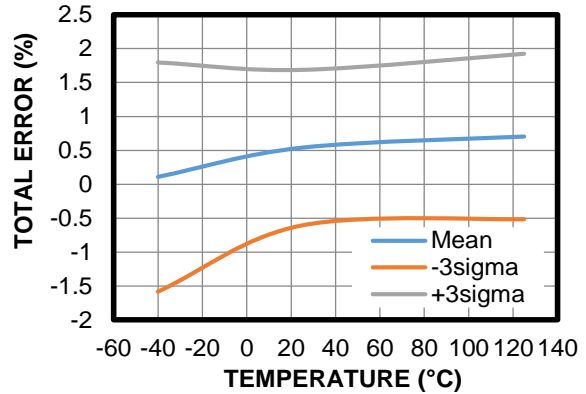

FUNCTIONAL BLOCK DIAGRAM

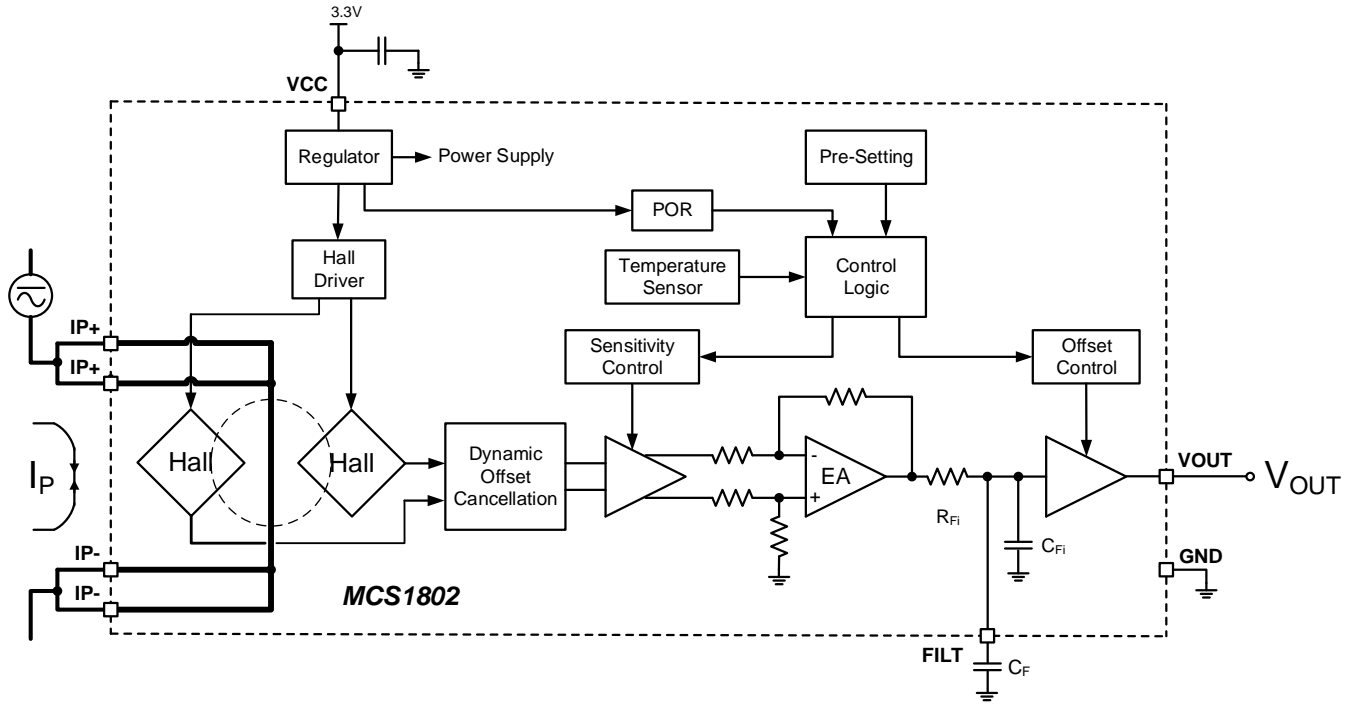

Figure 2: Functional Block Diagram

OPERATION

Current Rating

$I_{P_{MAX}}$ is the rated current. The sensor output is linear, as a function of the primary current (I_P). I_P follows the specified performances when I_P is between $-I_{P_{MAX}}$ and $+I_{P_{MAX}}$ (see Figure 3).

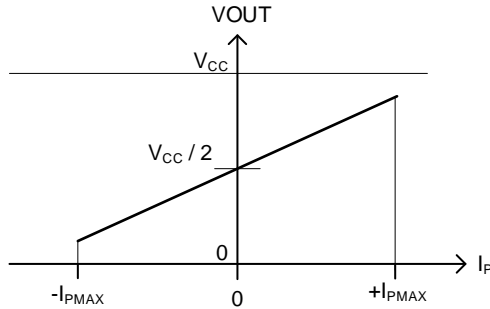

Figure 3: Sensor Output Function

Sensitivity (SENS)

The sensitivity (SENS) (in mV/A) indicates how the output changes when the primary current changes. SENS is the product of the average between the two coupling constants (P_{MCF1} and P_{MCF2}) (in mT/A) and the transducer gain (in mV/mT). The gain is factory-trimmed to the sensor target sensitivity.

Coupling Constants (P_{MCF1} and P_{MCF2})

Figure 4 shows a cross-section of the sensor. The first and second Hall magnetic coupling factors are defined as the amount of the vertical magnetic field (B_1 and B_2) produced at the sensing points 1 and 2, per unit of current injected in the primary conductor. Due to the asymmetrical shape of the primary conductor, the magnetic field generated at the two sensing points are different.

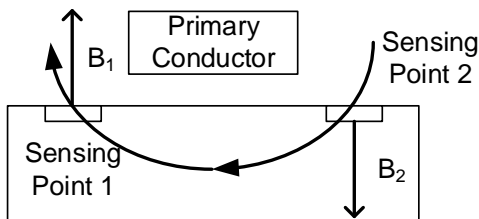

Figure 4: Cross Section of the Sensor

Noise (I_N)

The noise (I_N) is a random deviation that cannot be removed by calibrating the device. The input's referred noise is the root mean square of the sensor's output noise (in mV) divided by the

sensitivity (in mV/A). I_N represents the smallest current that the device is able to resolve without any external signal treatment.

Zero Current Output Voltage ($V_{OUT(Q)}$)

$V_{OUT(Q)}$ is the voltage output when the primary current is 0A. The nominal value is $V_{CC} / 2$.

Offset Voltage (V_{OE})

The offset voltage (V_{OE}) is the difference between $V_{CC}/2$ and the zero current output voltage $V_{OUT(Q)}$. The variation is due to thermal drift, as well as the factory's resolution limits related to voltage offset trimming. To convert this voltage into amperes, divide V_{OE} by the sensitivity.

Nonlinearity (E_{LIN})

The primary current and sensor output should have a linear relationship, indicated by a straight line. A line that is not straight indicates nonlinearity, which is a deviation.

Nonlinearity (in %) can be calculated with Equation (1):

$$E_{LIN} = \frac{\text{Max}(V_{OUT}(I_P) - V_{LIN}(I_P))}{V_{OUT}(I_{P_{MAX}}) - V_{OUT}(-I_{P_{MAX}})} \times 100 \quad (1)$$

Where $V_{LIN}(I_P)$ is the approximate straight line calculated by the least square method. Note that depending on the curvature of $V_{OUT}(I_P)$, E_{LIN} can be positive or negative.

Total Output Error (E_{TOT})

E_{TOT} (in %) is the relative difference between the sensor output and the ideal output at a given primary current (I_P). E_{TOT} can be estimated with Equation (2):

$$E_{TOT}(I_P) = \frac{V_{OUT}(I_P) - V_{OUT_IDEAL}(I_P)}{\text{SENS} \times I_P} \times 100 \quad (2)$$

Where V_{OUT_IDEAL} can be calculated with Equation (3):

$$V_{OUT_IDEAL}(I_P) = \frac{V_{CC}}{2} + \text{SENS} \times I_P \quad (3)$$

The total output error incorporates all error sources, and is a function of I_P . At currents close to $I_{P_{MAX}}$, E_{TOT} is affected mainly by the sensitivity error. At currents close to 0A, E_{TOT} is mostly caused by the offset voltage (V_{OE}). Note that

when $I_P = 0A$, E_{TOT} diverges to infinity due to the constant offset.

Ratiometry Coefficients

Ideally, the sensor output is ratiometric. This means that the sensitivity and the zero current output scale with V_{CC} . The ratiometry coefficients measure if the sensitivity and zero output current are proportional.

K_{SENS} can be calculated with Equation (4):

$$K_{SENS} = \frac{SENS(V_{CC}) / SENS(3.3V)}{V_{CC} / 3.3V} \quad (4)$$

K_{VO} can be calculated with Equation (5):

$$K_{VO} = \frac{V_{OUT}(I_P = 0, V_{CC}) / V_{OUT}(I_P = 0, 3.3V)}{V_{CC} / 3.3V} \quad (5)$$

Ideally, both K_{SENS} and K_{VO} are 1.

Power On Time (t_{PO})

The power on time (t_{PO}) is the time interval after power is first applied to the device, until the output can correctly indicate the applied primary current. t_{PO} is defined as the time between the following moments:

1. t_1 : The supply reaches the minimum operating voltage (V_{CC_UVLO}).
2. t_2 : V_{OUT} settles to 90% of its final value under an applied primary current (see Figure 5).

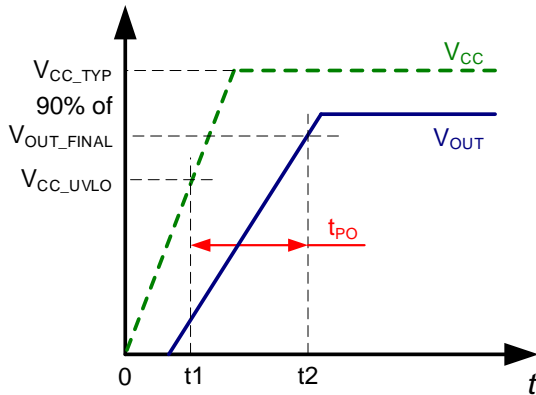

Figure 5: Power On Time (t_{PO})

Propagation Delay (t_{PD})

The propagation delay (t_{PD}) represents the internal latency between an event that has been measured and the sensor's response. t_{PD} is defined as the time between the following moments:

1. t_1 : The primary current signal reaches 20% of its final value.

2. t_2 : V_{OUT} reaches 20% of its final value, as it corresponds to the applied primary current (see Figure 6).

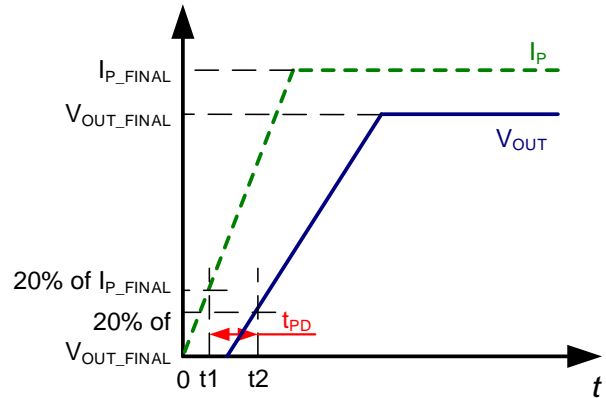

Figure 6: Propagation Delay (t_{PD})

Rising Time (t_R)

The rising time (t_R) is defined as the time between the following moments:

1. t_1 : The sensor's V_{OUT} reaches 10% of its full-scale value.
2. t_2 : The sensor's V_{OUT} reaches 90% of its full-scale value (see Figure 7).

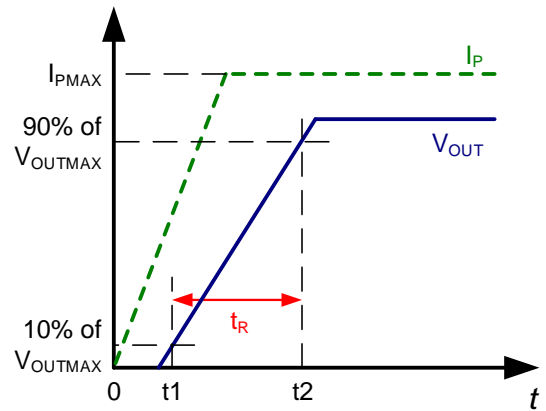

Figure 7: Rising Time (t_R)

The sensor bandwidth (f_{BW}) is defined as the 3dB cutoff frequency.

By using the rising time, f_{BW} can be estimated with Equation (6):

$$f_{BW} = 0.35 / t_R \quad (6)$$

Response Time ($t_{RESPONSE}$)

The response time ($t_{RESPONSE}$) is defined as the time between the following moments:

1. t_1 : The primary current signal reaches 90% of its final value.

2. t_2 : V_{OUT} reaches 90% of its final value, as it corresponds to the applied primary current (see Figure 8).

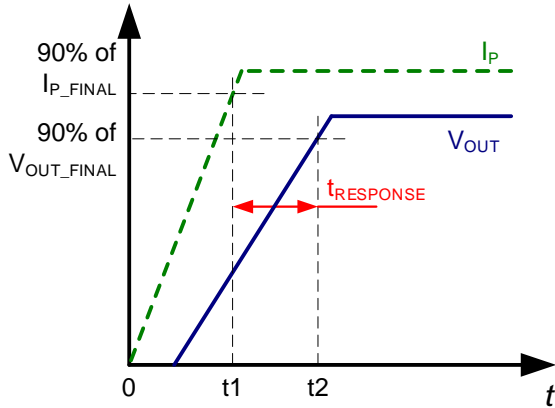

Figure 8: Response Time ($t_{RESPONSE}$)

Adjustable Bandwidth

The sensor dynamic can be adjusted with an external capacitor (C_F). In this scenario, the bandwidth (f_{BW}) can be calculated with Equation (7):

$$f_{BW} = \frac{1}{2\pi} \times \frac{1}{R_{Fi} \times (C_{Fi} + C_F)} \quad (7)$$

Where R_{Fi} is the internal filter resistance, C_{Fi} is the internal filter capacitance.

Figure 9 shows the typical bandwidth curve.

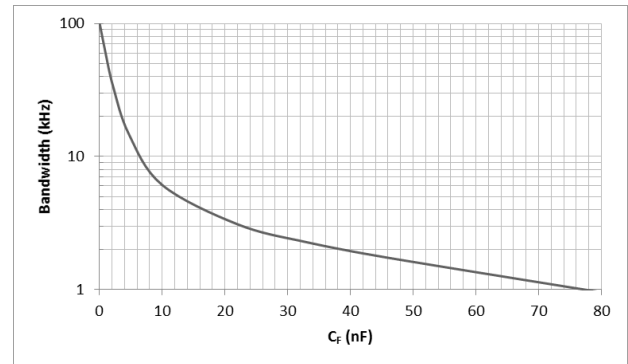

Figure 9: Bandwidth vs. C_F

APPLICATION INFORMATION

Self-Heating Performance

The conductor and MCS1802 temperatures can rise when current flows through the primary conductor. This means that self-heating should be carefully verified to ensure that the IC junction temperature does not exceed the maximum value 165°C.

The thermal behavior strongly depends on the thermal environment of the IC, as well as its cooling capacity. In particular, thermal behavior depends on the PCB copper area's thickness. The thermal response is also related to the current waveform's profile (e.g. the amplitude and frequency of an AC current, or the peaks and duty cycle of a pulsed DC current).

Figure 10 shows the self-heating performance of the MCS1802 with a DC current input. The data is collected when the MCS1802 is mounted on the device's evaluation board and $T_A = 25^\circ\text{C}$. Values were taken 10 minutes after a continuous current.

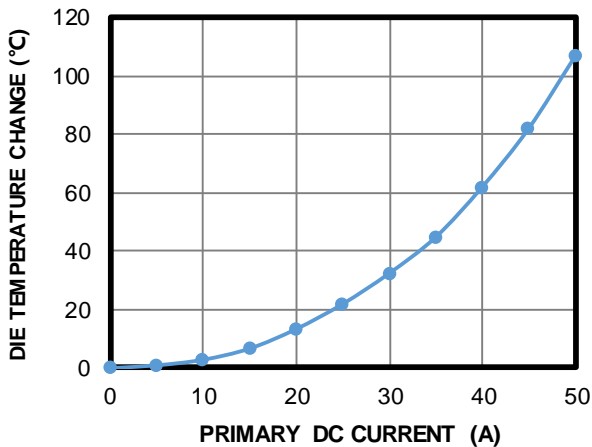
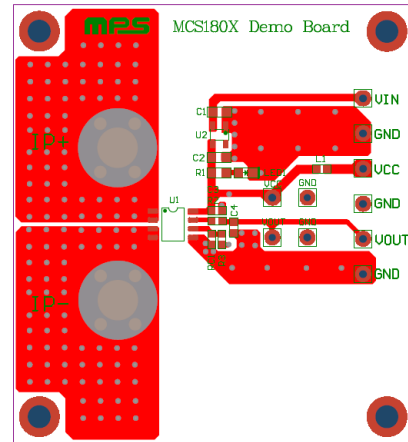
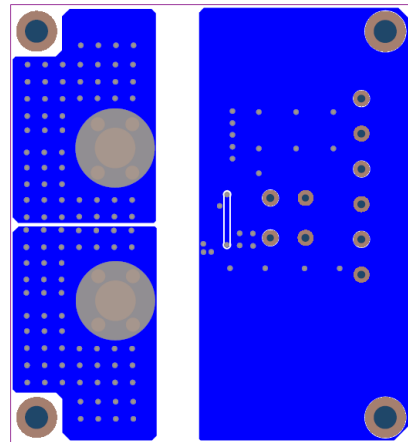

Figure 10: Self-Heating Performance with a DC Current Input

Figure 11 shows the top and bottom layers of the PCB. The board includes a total of 2200mm², 4oz (139µm) copper connected to the primary conductor by the IP+ and IP- pins. The copper covers both the top and bottom sides, and thermal vias connect the two layers.



Top Layer



Bottom Layer

Figure 11: Recommended PCB Layout

TYPICAL APPLICATION CIRCUIT

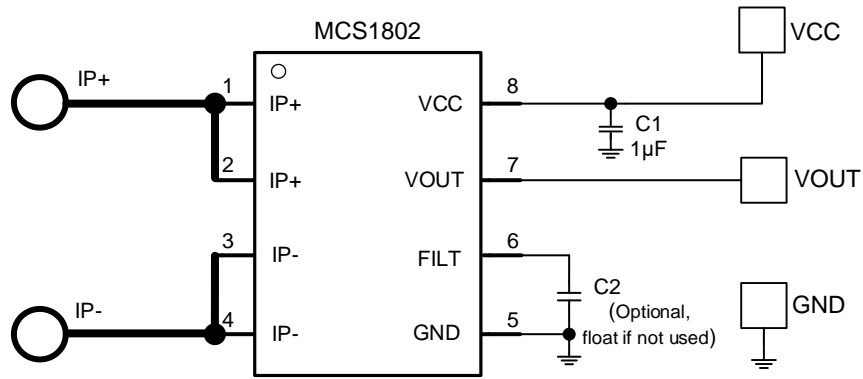
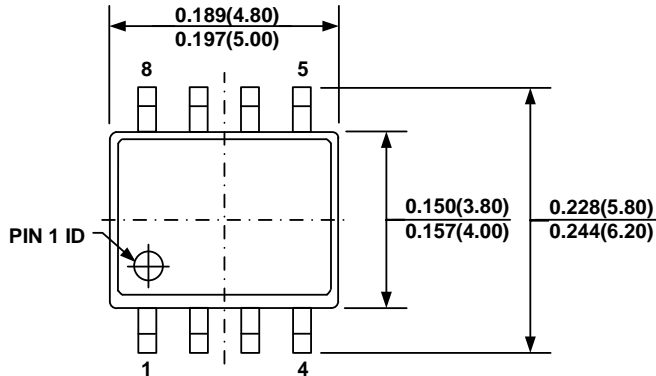

Figure 12: Typical Application Circuit

PACKAGE INFORMATION

SOIC-8



TOP VIEW

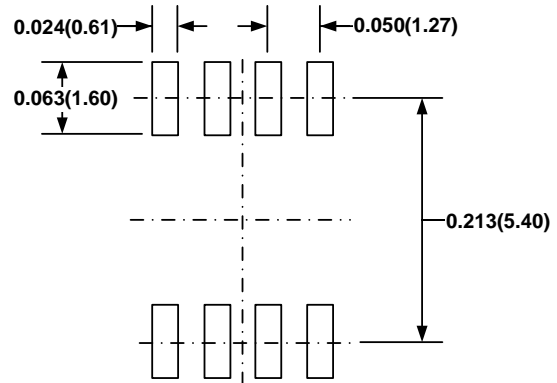

RECOMMENDED LAND PATTERN

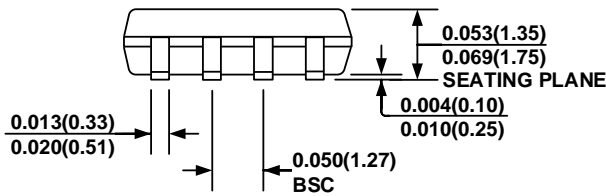

FRONT VIEW

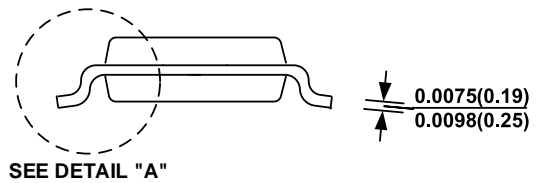

SIDE VIEW

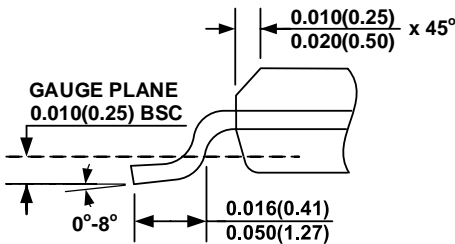

DETAIL "A"

NOTE:

- 1) CONTROL DIMENSION IS IN INCHES. DIMENSION IN BRACKET IS IN MILLIMETERS.
- 2) PACKAGE LENGTH DOES NOT INCLUDE MOLD FLASH, PROTRUSION, OR GATE BURR.
- 3) PACKAGE WIDTH DOES NOT INCLUDE INTERLEAD FLASH OR PROTRUSIONS.
- 4) LEAD COPLANARITY (BOTTOM OF LEADS AFTER FORMING) SHALL BE 0.004" INCHES MAX.
- 5) DRAWING CONFORMS TO JEDEC MS-012, VARIATION AA.
- 6) DRAWING IS NOT TO SCALE.

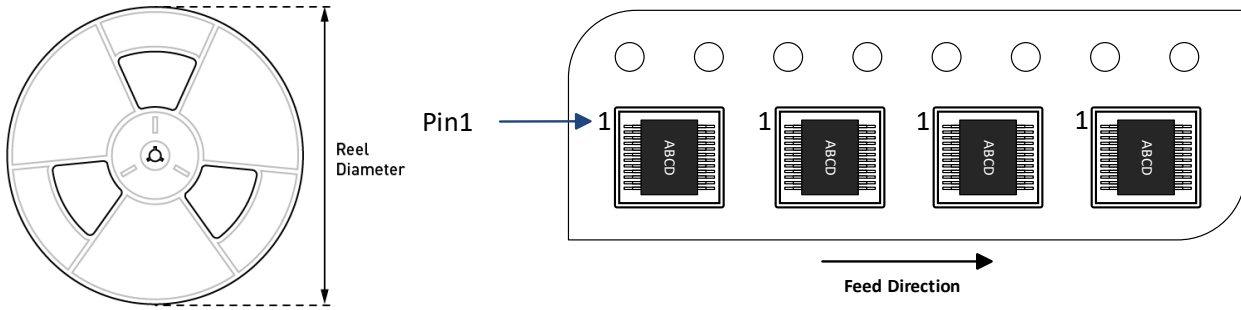
CARRIER INFORMATION

Part Number	Package Description	Quantity/ Reel	Quantity/ Tube	Quantity/ Tray	Reel Diameter	Carrier Tape Width	Carrier Tape Pitch
MCS1802GS-05-Z	SOIC-8	2500	N/A	N/A	13in	12mm	8mm
MCS1802GS-10-Z	SOIC-8	2500	N/A	N/A	13in	12mm	8mm
MCS1802GS-20-Z	SOIC-8	2500	N/A	N/A	13in	12mm	8mm
MCS1802GS-30-Z	SOIC-8	2500	N/A	N/A	13in	12mm	8mm
MCS1802GS-40-Z	SOIC-8	2500	N/A	N/A	13in	12mm	8mm
MCS1802GS-50-Z	SOIC-8	2500	N/A	N/A	13in	12mm	8mm