

Termination Insensitive Mixer

1 MHz - 3.5 GHz



MDx-169
Rev. V8

Features

- Intermodulation Ratio is Insensitive to Port Mismatches
- VSWR: <2.0:1 Midband
- Isolation: 35 dB Midband
- Impedance: 50 Ω Nominal
- Input Power: 350 mW Max. @ 25°C, Derated to 85°C @ 3.2 mW/°C
- LO Power: 24 dBm Max.
- MIL-STD-883 Screening Available

Applications

- Aerospace & Defense
- ISM

Description

The unique design of the termination insensitive mixer (TIM) enables it to apply high reverse voltage to diodes during their “off” phase, in the LO cycle. This allows for higher power level performance with minimum distortion. In addition the TIM has internal loads that provide a good match and also absorb mixer generated LO frequency terms. Combined, these features give the mixer its insensitivity to external mismatches, plus superior VSWR.

Ordering Information

Part Number	Package
MDC-169-SMA	C-7
MDS-169-PIN	SF-1
MD-169-PIN	FP-2

C-7 (MDC-169)

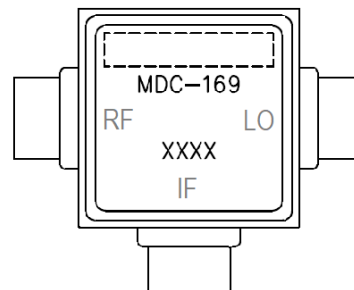

SF-1 (MDS-169)¹

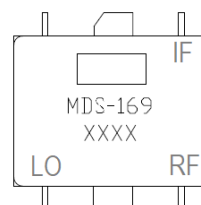

FP-2 (MD-169)¹

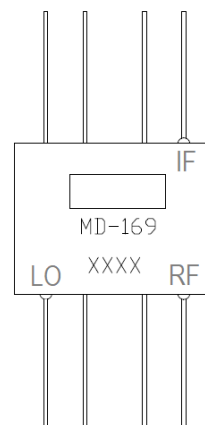

1. All pins not marked are ground pins.

Termination Insensitive Mixer

1 MHz - 3.5 GHz



MDx-169

Rev. V8

Electrical Specifications²:

Freq. RF & LO Ports = 0.001 - 3.5 GHz, IF Port = 5 - 1500 MHz, T_A = -55°C to +85°C

Parameter	Test Conditions	Units	Min.	Typ.	Max.
Conversion Loss ³	LO @ +10 dBm, IF @ 60 MHz 5 - 1000 MHz 1000 - 3000 MHz 1 - 3500 MHz	dB	—	—	7 9 10
Isolation	LO to RF & LO to IF 5 - 1000 MHz 1 - 3500 MHz RF to IF 10 - 500 MHz 1 - 3000 MHz 1 - 3500 MHz	dB	30 20 30 20 18	—	—
RF Input	1 dB Compression 1 dB Desensitization	dBm	—	7 5	—
SSB Noise Figure	—	dB	Within 1 dB of Conversion Loss Max.		
Typical Two-Tone IM Ratio	P _{IN} = -10 dBm per tone, IF = 60 MHz 10 MHz 500 MHz 3000 MHz	dB	—	55 58 56	—
3rd Order Intermodulation Ratio Degradation	@ IF VSWR 3:1	dB	—	3	—

2. All specifications apply when operated at 10 dBm available LO power with 50 Ω source and load impedance.

3. For MDC-169, add 1 dB to conversion loss.

Absolute Maximum Ratings (MDS-169)⁴

Parameter	Absolute Maximum
Total Power	350 mW Derated at 85°C @ 3.2 mW/°C
LO Power	24 dBm

4. Operation of this device above any one of these parameters may cause permanent damage.

Termination Insensitive Mixer

1 MHz - 3.5 GHz



MDx-169
Rev. V8

Typical Performance Curves

Conversion Loss - LO @ +10 dBm, IF @ 60 MHz

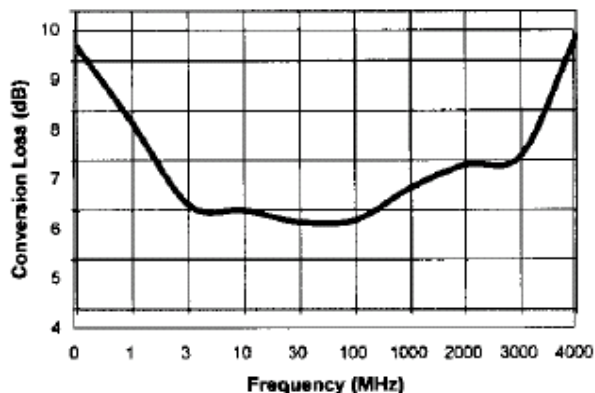

Conversion Loss vs. LO Power - RF @ 2000 MHz -10 dBm, IF @ 60 MHz

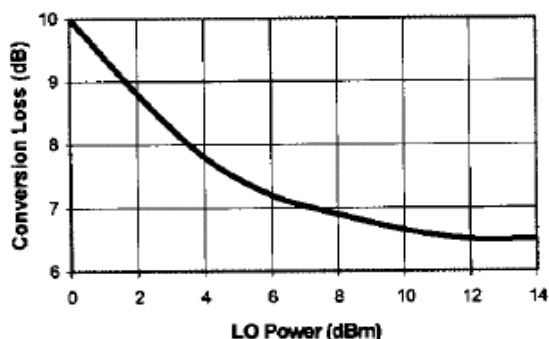

Isolation - Input +10 dBm

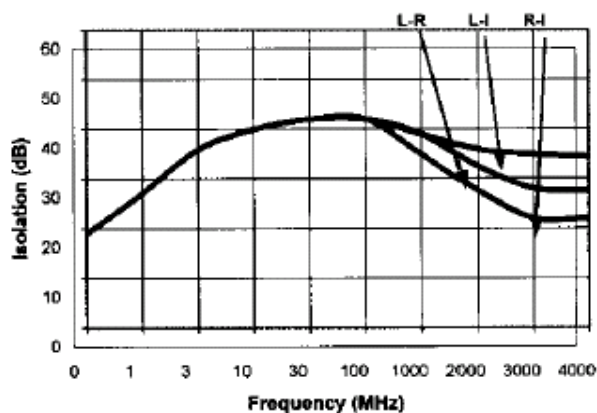

VSWR

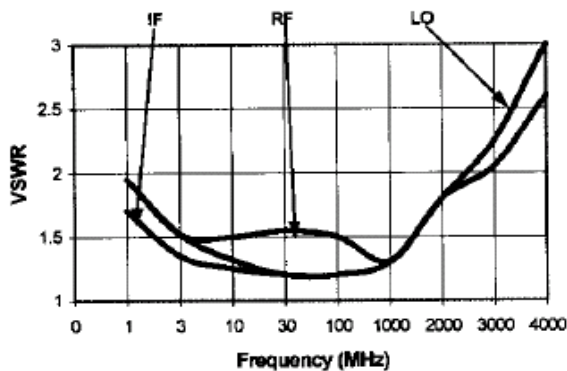

3rd Order IM Ratio - LO @ +10 dBm,

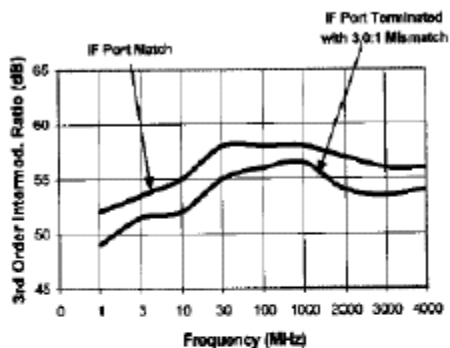

IF Port Response

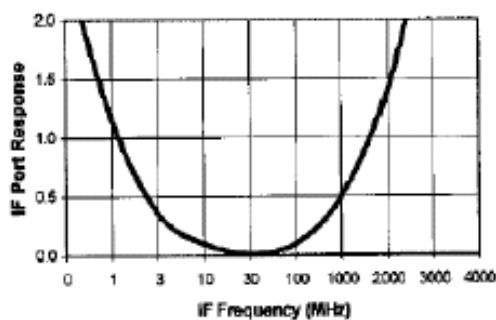

Termination Insensitive Mixer 1 MHz - 3.5 GHz



MDx-169
Rev. V8

C-7 (MDC-169)

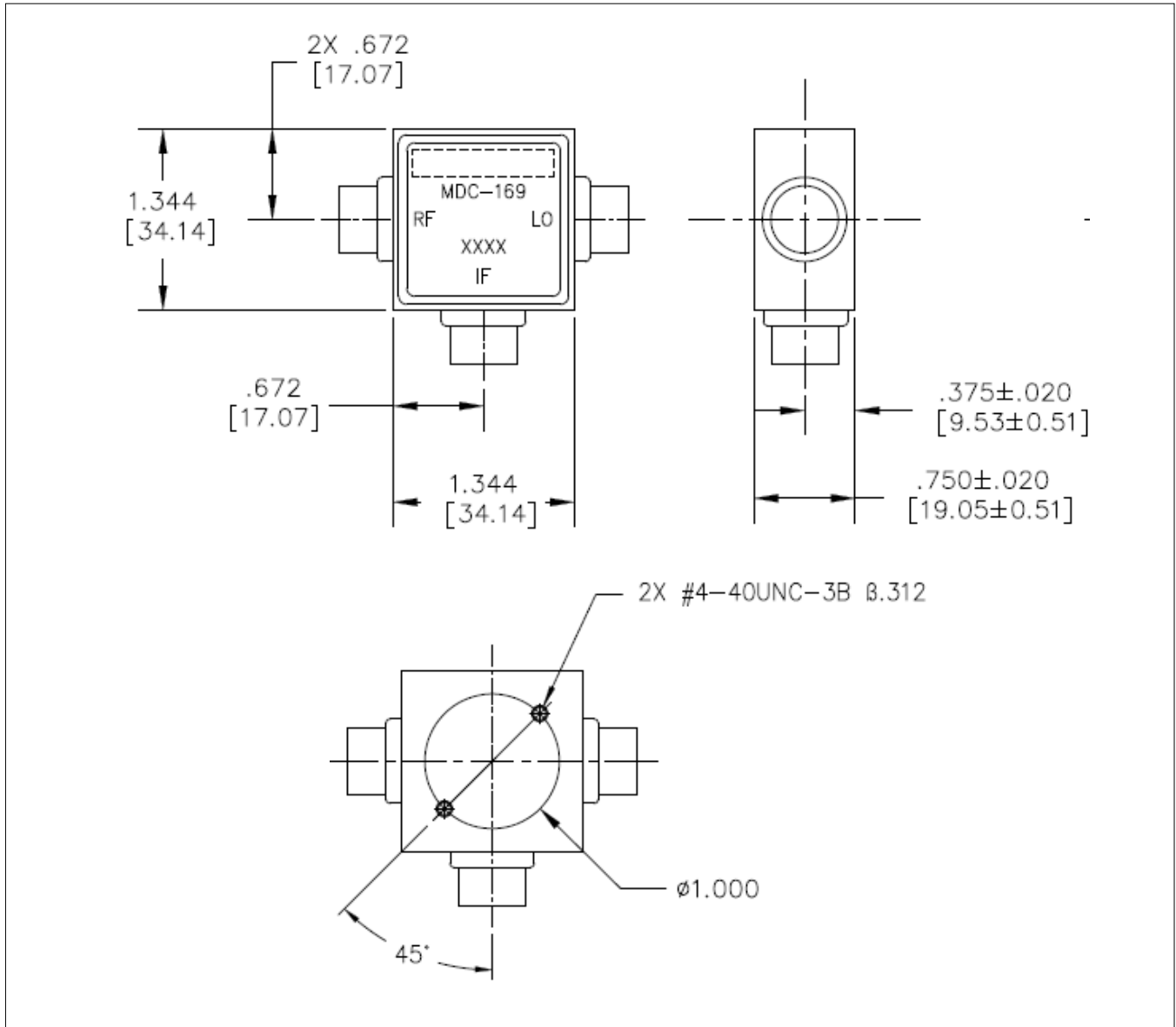

Termination Insensitive Mixer

1 MHz - 3.5 GHz



MDx-169
Rev. V8

SF-1 (MDS-169)¹

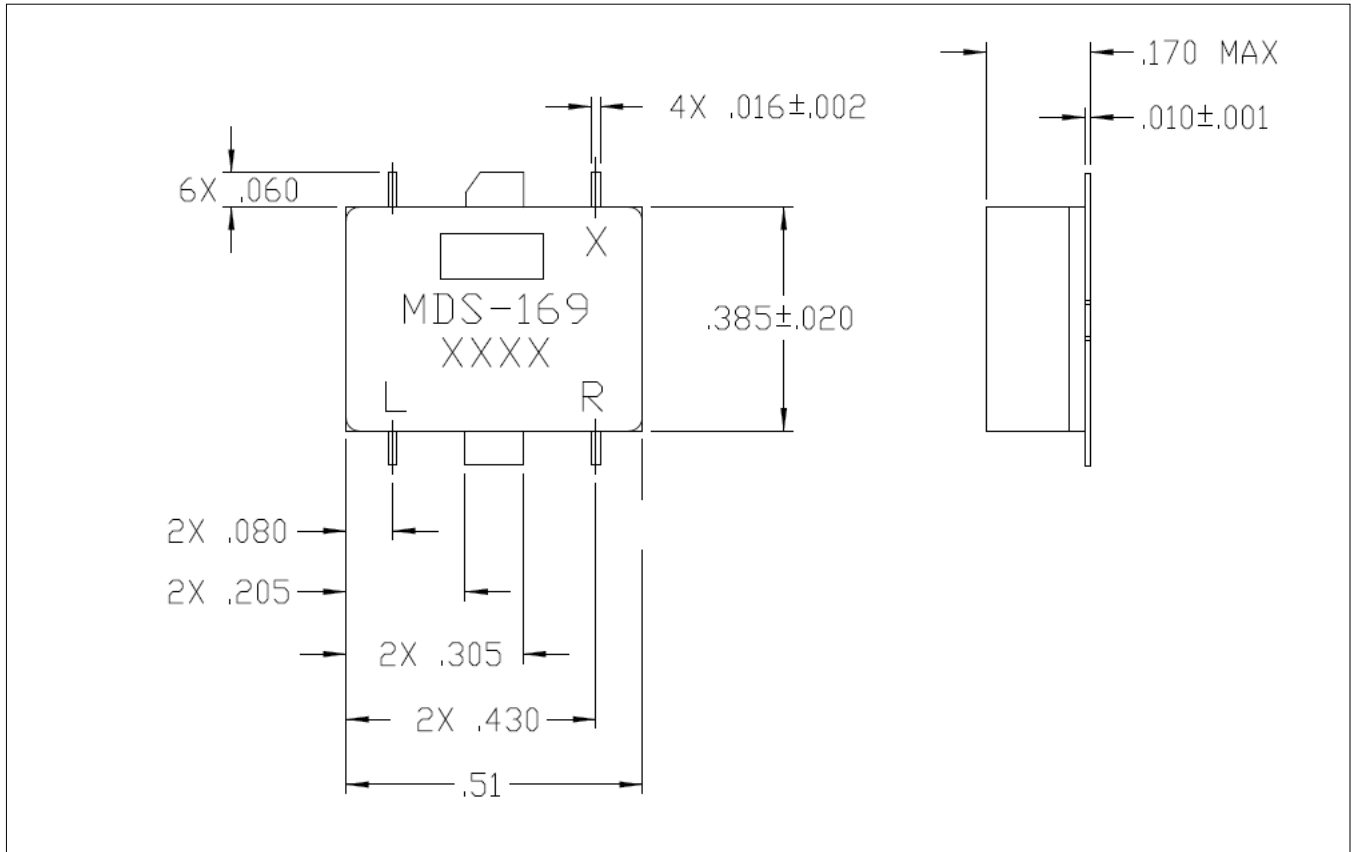

Bottom View of SF-1

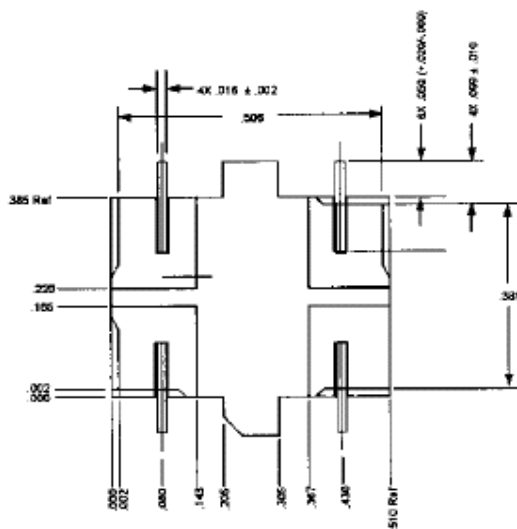

Termination Insensitive Mixer 1 MHz - 3.5 GHz



MDx-169
Rev. V8

FP-2 (MD-169)¹

