





Features

- Surface mount packaging for automated assembly
- Small footprint size (1206) and low profile for space-constrained mobile applications
- Ultra-low resistance
- Utilizes innovative freeXpansion™ design
- RoHS compliant* and halogen free**
- Agency recognition:  

Applications

- Thermal protection for Li-ion & polymer battery packs
- Power delivery port protection
- USB port protection
- PC motherboards - Plug & Play protection
- Mobile phones - Battery & charging protection
- Game console port protection

MF-NSML/X Series - Low Ohmic PTC Resettable Fuses

Electrical Characteristics

Model	V max. Volts	I max. Amps	I _{hold}	I _{trip}	Resistance		Max. Time To Trip		Tripped Power Dissipation
			Amperes at 23 °C		Ohms at 23 °C		Amperes at 23 °C	Seconds at 23 °C	Watts at 23 °C
			Hold	Trip	R _{Min.}	R _{1Max.}			Typ.
MF-NSML150/12	12	50	1.50	3.00	0.010	0.065	8.00	5.00	1.00
MF-NSML175/12	12	50	1.75	3.50	0.006	0.050	8.00	5.00	1.00
MF-NSML200/12	12	50	2.00	4.00	0.005	0.040	8.00	5.00	1.00
MF-NSML260/12	12	50	2.60	5.20	0.004	0.030	8.00	5.00	1.00
MF-NSML300/12	12	50	3.00	6.00	0.003	0.024	8.00	5.00	1.00
MF-NSML350/12	12	50	3.50	7.00	0.002	0.022	8.00	5.00	1.00
MF-NSML380/12	12	50	3.80	7.60	0.002	0.020	8.00	5.00	1.00
MF-NSML400/12	12	50	4.00	8.00	0.002	0.018	10.0	5.00	1.00
MF-NSML450/12	12	50	4.50	9.00	0.002	0.014	22.5	2.00	1.00

Environmental Characteristics

Operating Temperature.....	-40 °C to +85 °C
Storage Condition	
Before Opening	+40 °C max. / 70 % RH max.
After Opening.....	+40 °C max. / 10 % RH max.
Floor Condition After Opening	Consumption within 4 weeks at floor condition +30 °C max. / 60 % RH max.
Passive Aging	+85 °C, 1000 hours..... ±10 % typical resistance change
Humidity Aging.....	+85 °C, 85 % R.H. 100 hours ±15 % typical resistance change
Thermal Shock	+85 °C to -40 °C, 20 times..... ±30 % typical resistance change
Solvent Resistance.....	MIL-STD-202, Method 215 No change (marking still legible)
Vibration	MIL-STD-883C, Method 2007.1,..... No change (R _{min} <R<R _{1max}) Condition A
Moisture Sensitivity Level (MSL)	See Note
ESD Classification - HBM.....	6

Test Procedures and Requirements

Test	Test Conditions	Accept/Reject Criteria
Visual/Mech.	Verify dimensions and materials.....	Per MF physical description
Resistance.....	In still air @ 23 °C.....	R _{min} ≤ R ≤ R _{1max}
Time to Trip.....	At specified current, V _{max} , 23 °C.....	T ≤ max. time to trip (seconds)
Hold Current	30 min. at I _{hold}	No trip
Trip Cycle Life.....	V _{max} , I _{max} , 100 cycles.....	No arcing or burning
Trip Endurance	V _{max} , 48 hours	No arcing or burning
Solderability	245 °C ±5 °C, 5 seconds	95 % min. coverage

cUL File Number..... E174545
TÜV Certificate Number [R 50391579](#)



WARNING Cancer and Reproductive Harm - www.P65Warnings.ca.gov

* RoHS Directive 2015/863, Mar 31, 2015 and Annex.

** Bourns considers a product to be "halogen free" if (a) the Bromine (Br) content is 900 ppm or less; (b) the Chlorine (Cl) content is 900 ppm or less; and (c) the total Bromine (Br) and Chlorine (Cl) content is 1500 ppm or less.

Specifications are subject to change without notice.

Users should verify actual device performance in their specific applications.

The products described herein and this document are subject to specific legal disclaimers as set forth on the last page of this document, and at www.bourns.com/docs/legal/disclaimer.pdf.

MF-NSML/X Series - Low Ohmic PTC Resettable Fuses

BOURNS®

Product Dimensions

Model	A		B		C		D	E	
	Min.	Max.	Min.	Max.	Min.	Max.	Min.	Min.	Max.
MF-NSML150/12 MF-NSML175/12 MF-NSML200/12	$\frac{3.00}{(0.118)}$	$\frac{3.50}{(0.138)}$	$\frac{1.40}{(0.055)}$	$\frac{1.80}{(0.071)}$	$\frac{0.40}{(0.016)}$	$\frac{0.70}{(0.028)}$	$\frac{0.25}{(0.010)}$	$\frac{0.05}{(0.002)}$	$\frac{0.45}{(0.018)}$
MF-NSML260/12	$\frac{3.00}{(0.118)}$	$\frac{3.50}{(0.138)}$	$\frac{1.40}{(0.055)}$	$\frac{1.80}{(0.071)}$	$\frac{0.40}{(0.016)}$	$\frac{1.00}{(0.039)}$	$\frac{0.25}{(0.010)}$	$\frac{0.05}{(0.002)}$	$\frac{0.45}{(0.018)}$
MF-NSML300/12 MF-NSML350/12	$\frac{3.00}{(0.118)}$	$\frac{3.50}{(0.138)}$	$\frac{1.40}{(0.055)}$	$\frac{1.80}{(0.071)}$	$\frac{0.40}{(0.016)}$	$\frac{1.40}{(0.055)}$	$\frac{0.25}{(0.010)}$	$\frac{0.05}{(0.002)}$	$\frac{0.45}{(0.018)}$
MF-NSML380/12 MF-NSML400/12 MF-NSML450/12	$\frac{3.00}{(0.118)}$	$\frac{3.50}{(0.138)}$	$\frac{1.40}{(0.055)}$	$\frac{1.80}{(0.071)}$	$\frac{0.60}{(0.024)}$	$\frac{1.40}{(0.055)}$	$\frac{0.25}{(0.010)}$	$\frac{0.05}{(0.002)}$	$\frac{0.45}{(0.018)}$

DIMENSIONS: $\frac{\text{MM}}{\text{(INCHES)}}$

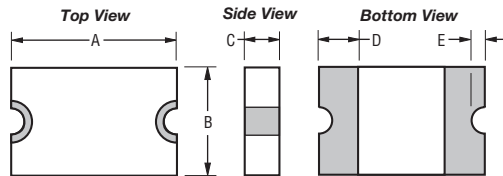

Terminal material:
ENIG-plated terminals

Recommended Pad Layout

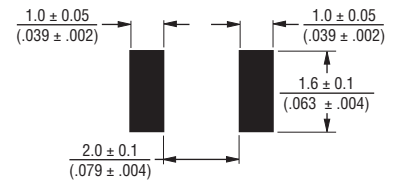

Packaging Quantity

MF-NSML150/12~MF-NSML260/12 = 5000 pcs. per reel
MF-NSML300/12~MF-NSML450/12 = 3500 pcs. per reel

Thermal Derating Table - I_{hold} (Amps)

Model	Ambient Operating Temperature								
	-40 °C	-20 °C	0 °C	23 °C	40 °C	50 °C	60 °C	70 °C	85 °C
MF-NSML150/12	2.20	2.00	1.77	1.50	1.28	1.15	1.07	0.85	0.70
MF-NSML175/12	2.57	2.33	2.07	1.75	1.49	1.34	1.24	1.00	0.80
MF-NSML200/12	2.94	2.65	2.35	2.00	1.70	1.53	1.42	1.14	0.93
MF-NSML260/12	3.82	3.46	3.07	2.60	2.21	1.95	1.85	1.48	1.20
MF-NSML300/12	4.41	3.99	3.54	3.00	2.55	2.32	2.13	1.71	1.38
MF-NSML350/12	5.25	4.66	4.13	3.50	2.98	2.71	2.49	2.00	1.65
MF-NSML380/12	5.59	5.05	4.48	3.80	3.23	2.95	2.60	2.15	1.75
MF-NSML400/12	5.80	5.25	4.65	4.00	3.40	3.10	2.65	2.20	1.80
MF-NSML450/12	6.10	5.40	4.70	4.50	3.60	3.15	2.70	2.25	1.85

Specifications are subject to change without notice.

Users should verify actual device performance in their specific applications.

The products described herein and this document are subject to specific legal disclaimers as set forth on the last page of this document, and at www.bourns.com/docs/legal/disclaimer.pdf.

MF-NSML/X Series - Low Ohmic PTC Resettable Fuses



Solder Reflow Recommendations

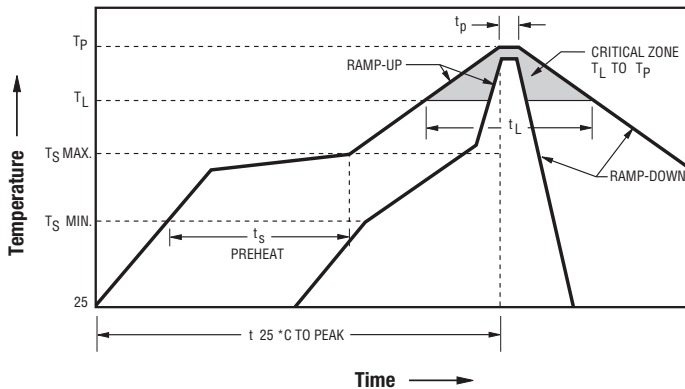

Notes:

- MF-NSML/X models cannot be wave soldered or hand soldered. Please contact Bourns for soldering recommendations.
- All temperatures refer to topside of the package, measured on the package body surface.
- If reflow temperatures exceed the recommended profile, devices may not meet the published specifications.
- Compatible with Pb and Pb-free solder reflow profiles.
- Excess solder may cause a short circuit, especially during hand soldering. Please refer to the Multifuse® Polymer PTC Soldering Recommendation guidelines.
- Designed for single solder reflow operations.

Profile Feature	Pb-Free Assembly
Average Ramp-Up Rate ($T_{s_{max}}$ to T_p)	3 °C / second max.
PREHEAT:	
Temperature Min. ($T_{s_{min}}$)	150 °C
Temperature Max. ($T_{s_{max}}$)	200 °C
Time ($T_{s_{min}}$ to $T_{s_{max}}$) (t_s)	60~180 seconds
TIME MAINTAINED ABOVE:	
Temperature (T_L)	217 °C
Time (t_L)	60~150 seconds
Peak Temperature (T_p)	260 °C
Time within 5 °C of Actual Peak Temperature (t_p)	20~40 seconds
Ramp-Down Rate	6 °C / second max.
Time 25 °C to Peak Temperature	8 minutes max.

How to Order

MF - NSML 380 / 12 - 2

Multifuse® Product Designator _____
 Series _____
 NSML = 1206 Low Ohmic Surface Mount Component
 Hold Current, I_{hold} _____
 150 - 450 (1.50 Amps - 4.50 Amps)
 Maximum Voltage, V_{max} _____
 12 = 12 Volts
 Packaging _____
 -2 = Tape and Reel
 Packaged per EIA 481

Typical Part Marking

Represents total content. Layout may vary.

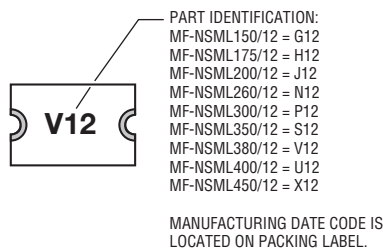

Asia-Pacific:

Tel: +886-2 2562-4117
 Email: asiacus@bourns.com

Europe:

Tel: +36 88 520 390
 Email: eurocus@bourns.com

The Americas:

Tel: +1-951 781-5500
 Email: americus@bourns.com
www.bourns.com

MF-NSML/X Series Tape and Reel Specifications

BOURNS®

Tape Dimensions	MF-NSML/X Series per EIA 481
W	12.0 ± 0.30 (0.472 ± 0.012)
P ₀	4.0 ± 0.10 (0.157 ± 0.004)
P ₁	4.0 ± 0.10 (0.157 ± 0.004)
P ₂	2.0 ± 0.05 (0.079 ± 0.002)
A ₀	1.90 ± 0.10 (0.075 ± 0.004)
B ₀	3.50 ± 0.10 (0.138 ± 0.004)
B ₁ max.	4.5 (0.177)
D ₀	$1.5 + 0.10/-0.0$ (0.059 + 0.004/-0)
F	5.5 ± 0.05 (0.216 + 0.002)
E ₁	1.75 ± 0.10 (0.069 ± 0.004)
E ₂ typ.	10.25 (0.404)
T max.	0.6 (0.024)
T ₁ max.	0.1 (0.004)
K ₀ (MF-NSML150/12~MF-NSML260/12)	0.65 ± 0.10 (0.026 ± 0.004)
K ₀ (MF-NSML300/12~MF-NSML450/12)	1.10 ± 0.10 (0.043 ± 0.004)
Leader min.	390 (15.35)
Trailer min.	160 (6.30)
Reel Dimensions	
A max.	185 (7.283)
N min.	50 (1.97)
W ₁	$12.4 + 1/-0$ (0.488 + 0.039/-0)
W ₂ max.	15.4 (0.606)

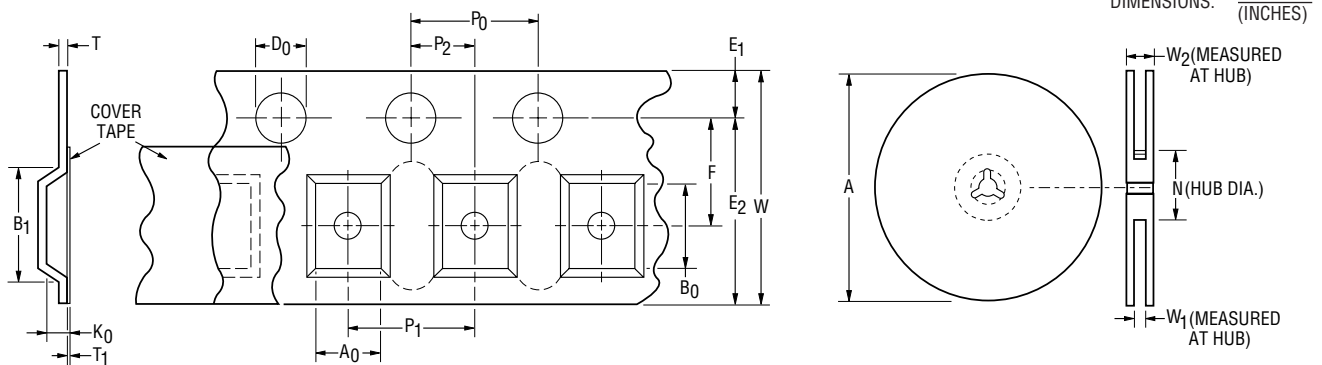

Specifications are subject to change without notice.
 Users should verify actual device performance in their specific applications.
 The products described herein and this document are subject to specific legal disclaimers as set forth on the last page of this document, and at www.bourns.com/docs/legal/disclaimer.pdf.

Application Notice

- Users are responsible for independent and adequate evaluation of Bourns® Multifuse® Polymer PTC devices in the user's application, including the PPTC device characteristics stated in the applicable data sheet.
- Polymer PTC devices must not be allowed to operate beyond their stated maximum ratings. Operation in excess of such maximum ratings could result in damage to the PTC device and possibly lead to electrical arcing and/or fire. Circuits with inductance may generate a voltage above the rated voltage of the polymer PTC device and should be thoroughly evaluated within the user's application during the PTC selection and qualification process.
- Polymer PTC devices are intended to protect against adverse effects of temporary overcurrent or overtemperature conditions up to rated limits and are not intended to serve as protective devices where overcurrent or overvoltage conditions are expected to be repetitive or prolonged.
- In normal operation, polymer PTC devices experience thermal expansion under fault conditions. Thus, a polymer PTC device must be protected against mechanical stress, and must be given adequate clearance within the user's application to accommodate such thermal expansion. Rigid potting materials or fixed housings or coverings that do not provide adequate clearance should be thoroughly examined and tested by the user, as they may result in the malfunction of polymer PTC devices if the thermal expansion is inhibited.
- Exposure to lubricants, silicon-based oils, solvents, gels, electrolytes, acids, and other related or similar materials may adversely affect the performance of polymer PTC devices.
- Aggressive solvents may adversely affect the performance of polymer PTC devices. Conformal coating, encapsulating, potting, molding, and sealing materials may contain aggressive solvents including but not limited to xylene and toluene, which are known to cause adverse effects on the performance of polymer PTCs. Such aggressive solvents must be thoroughly cured or baked to ensure their complete removal from polymer PTCs to minimize the possible adverse effect on the device.
- Recommended storage conditions should be followed at all times. Such conditions can be found on the applicable data sheet and on the Multifuse® Polymer PTC Moisture/Reflow Sensitivity Classification (MSL) note:
https://www.bourns.com/docs/RoHS-MSL/msl_mf.pdf