



## Features

- 72 V rated
- Cured, flame retardant epoxy polymer insulating material meets UL 94 V-0 requirements
- RoHS compliant\* and halogen free\*\*
- Agency recognition: 

## Applications

Almost anywhere there is a low voltage power supply, up to 72 V and a load to be protected, including:

- Security and fire alarm systems
- Loudspeakers
- Power transformers

## MF-RX/72 Series - PTC Resettable Fuses

### Electrical Characteristics

| Model       | V <sub>max</sub> | I <sub>max</sub> | I <sub>hold</sub> | I <sub>trip</sub> | Initial Resistance |      | 1 Hour (R <sub>1</sub> ) Post-Trip Resistance | Max. Time to Trip |         | Tripped Power Dissipation | Agency Recognition |           |
|-------------|------------------|------------------|-------------------|-------------------|--------------------|------|---|-------------------|---------|---------------------------|--------------------|-----------|
|             |                  |                  | at 23 °C          |                   | at 23 °C Ohms      |      | at 23 °C Ohms                                 | at 23 °C          |         | at 23 °C Watts            | cUL                | TÜV       |
|             | Volts            | Amps             | Amps              |                   | Min.               | Max. | Max.  | Amps              | Seconds | Typ.                      | E174545            | R50366745 |
| MF-RX020/72 | 72               | 40               | 0.20              | 0.40              | 1.50               | 2.84 | 4.40  | 1.00              | 2.2     | 0.40                      | ✓                  | ✓         |
| MF-RX025/72 | 72               | 40               | 0.25              | 0.50              | 1.00               | 1.95 | 3.00  | 1.25              | 2.5     | 0.45                      | ✓                  | ✓         |
| MF-RX030/72 | 72               | 40               | 0.30              | 0.60              | 0.76               | 1.36 | 2.10  | 1.50              | 3.0     | 0.50                      | ✓                  | ✓         |
| MF-RX040/72 | 72               | 40               | 0.40              | 0.80              | 0.52               | 0.86 | 1.29  | 2.00              | 3.9     | 0.55                      | ✓                  | ✓         |
| MF-RX050/72 | 72               | 40               | 0.50              | 1.00              | 0.41               | 0.77 | 1.17  | 2.50              | 4.0     | 0.75                      | ✓                  | ✓         |
| MF-RX065/72 | 72               | 40               | 0.65              | 1.30              | 0.27               | 0.48 | 0.72  | 3.25              | 5.3     | 0.90                      | ✓                  | ✓         |
| MF-RX075/72 | 72               | 40               | 0.75              | 1.50              | 0.18               | 0.40 | 0.60  | 3.75              | 6.3     | 0.90                      | ✓                  | ✓         |
| MF-RX090/72 | 72               | 40               | 0.90              | 1.80              | 0.14               | 0.31 | 0.47  | 4.50              | 7.2     | 1.00                      | ✓                  | ✓         |
| MF-RX110/72 | 72               | 40               | 1.10              | 2.20              | 0.15               | 0.25 | 0.38  | 5.50              | 8.2     | 1.50                      | ✓                  | ✓         |
| MF-RX135/72 | 72               | 40               | 1.35              | 2.70              | 0.12               | 0.19 | 0.30  | 6.75              | 9.6     | 1.70                      | ✓                  | ✓         |
| MF-RX160/72 | 72               | 40               | 1.60              | 3.20              | 0.09               | 0.14 | 0.22  | 8.00              | 11.4    | 1.90                      | ✓                  | ✓         |
| MF-RX185/72 | 72               | 40               | 1.85              | 3.70              | 0.08               | 0.12 | 0.19  | 9.25              | 12.6    | 2.10                      | ✓                  | ✓         |
| MF-RX250/72 | 72               | 40               | 2.50              | 5.00              | 0.05               | 0.08 | 0.13  | 12.50             | 15.6    | 2.50                      | ✓                  | ✓         |
| MF-RX300/72 | 72               | 40               | 3.00              | 6.00              | 0.04               | 0.06 | 0.10  | 15.00             | 19.8    | 2.80                      | ✓                  | ✓         |
| MF-RX375/72 | 72               | 40               | 3.75              | 7.50              | 0.03               | 0.05 | 0.08  | 18.75             | 24.0    | 3.20                      | ✓                  | ✓         |

### Environmental Characteristics

| Item                             | Condition                               | Criteria  |
|----------------------------------|---|---|
| Operating Temperature            | -40 °C to +85 °C                        |   |
| Recommended Storage              | +40 °C max. / 70 % R.H. max.            |   |
| Passive Aging                    | +85 °C, 1000 hours                      | ±5 % typical resistance change                        |
| Humidity Aging                   | +85 °C, 85 % R.H. 1000 hours            | ±5 % typical resistance change                        |
| Thermal Shock                    | -40 °C to +85 °C, 10 times              | ±10 % typical resistance change                       |
| Solvent Resistance               | MIL-STD-202, Method 215                 | No change (marking still legible)                     |
| Vibration                        | MIL-STD-883C, Method 2007.1 Condition A | No change (R <sub>min</sub> < R < R <sub>1max</sub> ) |
| Moisture Sensitivity Level (MSL) | <a href="#">See Note</a>                |   |
| ESD Classification               | Class 6 (per AEC-Q200-2, HBM)           |   |

### Test Procedures and Requirements

| Item              | Test Condition                                       | Accept/Reject Criteria                  |
|-------------------|--|---|
| Visual/Mechanical | Verify dimensions and materials                      | Per MF physical description             |
| Resistance        | In still air @ 23 °C                                 | R <sub>min</sub> ≤ R ≤ R <sub>max</sub> |
| Time to Trip      | 5 times I <sub>hold</sub> , V <sub>max</sub> , 23 °C | T ≤ max. time to trip (seconds)         |
| Hold Current      | 30 min. at I <sub>hold</sub>                         | No trip                                 |
| Trip Cycle Life   | V <sub>max</sub> , I <sub>max</sub> , 100 cycles     | No arcing or burning                    |
| Trip Endurance    | V <sub>max</sub> , 48 hours                          | No arcing or burning                    |
| Solderability     | 245 °C ±5 °C, 5 seconds                              | 95 % min. coverage                      |



**WARNING Cancer and Reproductive Harm - [www.P65Warnings.ca.gov](http://www.P65Warnings.ca.gov)**

\* RoHS Directive 2015/863, Mar 31, 2015 and Annex.  
 \*\* Bourns follows the prevailing definition of "halogen free" in the industry. Bourns considers a product to be "halogen free" if (a) the Bromine (Br) content is 900 ppm or less; (b) the Chlorine (Cl) content is 900 ppm or less; and (c) the total Bromine (Br) and Chlorine (Cl) content is 1500 ppm or less.

Specifications are subject to change without notice. Users should verify actual device performance in their specific applications. The products described herein and this document are subject to specific legal disclaimers as set forth on the last page of this document, and at [www.bourns.com/docs/legal/disclaimer.pdf](http://www.bourns.com/docs/legal/disclaimer.pdf).

# MF-RX/72 Series - PTC Resettable Fuses

**BOURNS®**

## Product Dimensions

| Model       | A                | B                | C               |                   | D              | E               | Physical Characteristics |                      |          |
|-------------|------------------|------------------|-----------------|-------------------|----------------|-----------------|--------------------------|----------------------|----------|
|             | Max.<br>(0.291)  | Max.<br>(0.5)    | Nom.<br>(0.201) | Tol. ±<br>(0.028) | Min.<br>(0.30) | Max.<br>(0.122) | Style                    | Lead Dia.<br>(0.020) | Material |
| MF-RX020/72 | 7.4<br>(0.291)   | 12.7<br>(0.5)    | 5.1<br>(0.201)  | 0.7<br>(0.028)    | 7.6<br>(0.30)  | 3.1<br>(0.122)  | 1                        | 0.51<br>(0.020)      | Sn/CuFe  |
| MF-RX025/72 | 7.4<br>(0.291)   | 12.7<br>(0.5)    | 5.1<br>(0.201)  | 0.7<br>(0.028)    | 7.6<br>(0.30)  | 3.1<br>(0.122)  | 1                        | 0.51<br>(0.020)      | Sn/CuFe  |
| MF-RX030/72 | 7.4<br>(0.291)   | 13.4<br>(0.528)  | 5.1<br>(0.201)  | 0.7<br>(0.028)    | 7.6<br>(0.30)  | 3.1<br>(0.122)  | 1                        | 0.51<br>(0.020)      | Sn/CuFe  |
| MF-RX040/72 | 7.4<br>(0.291)   | 13.7<br>(0.539)  | 5.1<br>(0.201)  | 0.7<br>(0.028)    | 7.6<br>(0.30)  | 3.1<br>(0.122)  | 1                        | 0.51<br>(0.020)      | Sn/CuFe  |
| MF-RX050/72 | 7.9<br>(0.311)   | 13.7<br>(0.539)  | 5.1<br>(0.201)  | 0.7<br>(0.028)    | 7.6<br>(0.30)  | 3.1<br>(0.122)  | 1                        | 0.51<br>(0.020)      | Sn/Cu    |
| MF-RX065/72 | 9.7<br>(0.382)   | 15.2<br>(0.598)  | 5.1<br>(0.201)  | 0.7<br>(0.028)    | 7.6<br>(0.30)  | 3.1<br>(0.122)  | 1                        | 0.51<br>(0.020)      | Sn/Cu    |
| MF-RX075/72 | 10.4<br>(0.409)  | 16.0<br>(0.630)  | 5.1<br>(0.201)  | 0.7<br>(0.028)    | 7.6<br>(0.30)  | 3.1<br>(0.122)  | 1                        | 0.51<br>(0.020)      | Sn/Cu    |
| MF-RX090/72 | 11.7<br>(0.461)  | 16.70<br>(0.657) | 5.1<br>(0.201)  | 0.7<br>(0.028)    | 7.6<br>(0.30)  | 3.1<br>(0.122)  | 1                        | 0.51<br>(0.020)      | Sn/Cu    |
| MF-RX110/72 | 10.84<br>(0.427) | 16.84<br>(0.663) | 5.1<br>(0.201)  | 0.7<br>(0.028)    | 7.6<br>(0.30)  | 3.1<br>(0.122)  | 2                        | 0.81<br>(0.032)      | Sn/Cu    |
| MF-RX135/72 | 12.26<br>(0.483) | 18.26<br>(0.719) | 5.1<br>(0.201)  | 0.7<br>(0.028)    | 7.6<br>(0.30)  | 3.1<br>(0.122)  | 2                        | 0.81<br>(0.032)      | Sn/Cu    |
| MF-RX160/72 | 13.94<br>(0.549) | 19.94<br>(0.785) | 5.1<br>(0.201)  | 0.7<br>(0.028)    | 7.6<br>(0.30)  | 3.1<br>(0.122)  | 2                        | 0.81<br>(0.032)      | Sn/Cu    |
| MF-RX185/72 | 15.18<br>(0.598) | 21.18<br>(0.834) | 5.1<br>(0.201)  | 0.7<br>(0.028)    | 7.6<br>(0.30)  | 3.1<br>(0.122)  | 2                        | 0.81<br>(0.032)      | Sn/Cu    |
| MF-RX250/72 | 17.84<br>(0.702) | 23.84<br>(0.939) | 10.2<br>(0.402) | 0.7<br>(0.028)    | 7.6<br>(0.30)  | 3.1<br>(0.122)  | 2                        | 0.81<br>(0.032)      | Sn/Cu    |
| MF-RX300/72 | 20.67<br>(0.814) | 26.67<br>(1.050) | 10.2<br>(0.402) | 0.7<br>(0.028)    | 7.6<br>(0.30)  | 3.1<br>(0.122)  | 2                        | 0.81<br>(0.032)      | Sn/Cu    |
| MF-RX375/72 | 23.51<br>(0.926) | 29.51<br>(1.162) | 10.2<br>(0.402) | 0.7<br>(0.028)    | 7.6<br>(0.30)  | 3.1<br>(0.122)  | 2                        | 0.81<br>(0.032)      | Sn/Cu    |

DIMENSIONS:  $\frac{\text{MM}}{\text{(INCHES)}}$

### Style 1

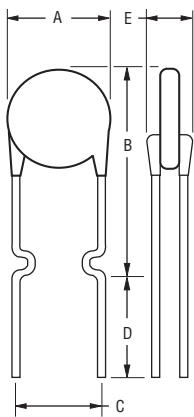

### Style 2

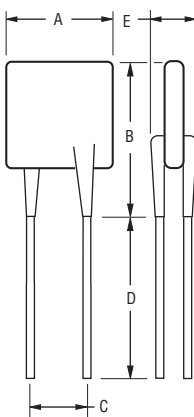

Also available with kinked and straight leads in place of standard leads (see How to Order).

### Typical Part Marking

Represents total content. Layout may vary.

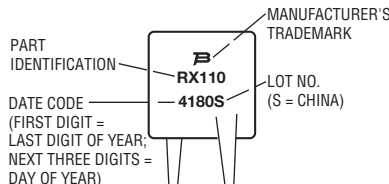

### How to Order

#### MF - RX 110/72 - 2 - 14

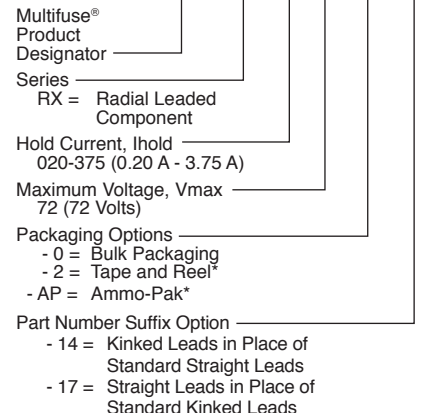

\*Packaged per EIA-468

Specifications are subject to change without notice.

Users should verify actual device performance in their specific applications.

The products described herein and this document are subject to specific legal disclaimers as set forth on the last page of this document, and at [www.bourns.com/docs/legal/disclaimer.pdf](http://www.bourns.com/docs/legal/disclaimer.pdf).

# MF-RX/72 Series - PTC Resettable Fuses

**BOURNS®**

## Typical Time to Trip at 23 °C

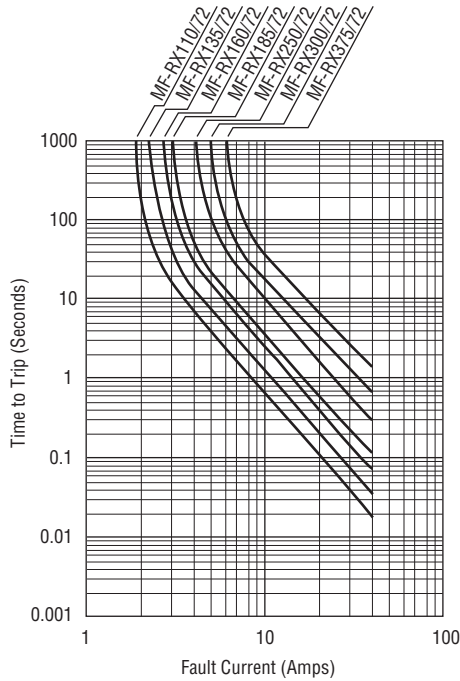
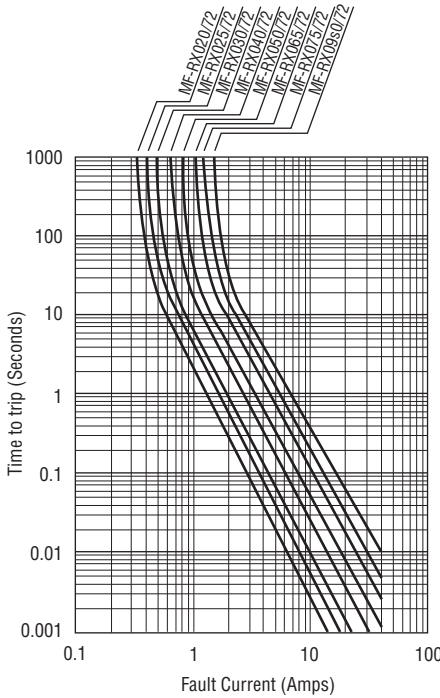

The Time to Trip curves represent typical performance of a device in a simulated application environment. Actual performance in specific customer applications may differ from these values due to the influence of other variables.

## Thermal Derating Table - $I_{hold}$ (Amps)

| Model       | Ambient Operating Temperature |        |      |       |       |       |       |       |       |
|-------------|-------------------------------|--------|------|-------|-------|-------|-------|-------|-------|
|             | -40 °C                        | -20 °C | 0 °C | 23 °C | 40 °C | 50 °C | 60 °C | 70 °C | 85 °C |
| MF-RX020/72 | 0.31                          | 0.27   | 0.24 | 0.20  | 0.16  | 0.14  | 0.13  | 0.11  | 0.08  |
| MF-RX025/72 | 0.39                          | 0.34   | 0.30 | 0.25  | 0.20  | 0.18  | 0.16  | 0.14  | 0.10  |
| MF-RX030/72 | 0.47                          | 0.41   | 0.36 | 0.30  | 0.24  | 0.22  | 0.19  | 0.16  | 0.12  |
| MF-RX040/72 | 0.62                          | 0.54   | 0.48 | 0.40  | 0.32  | 0.29  | 0.25  | 0.22  | 0.16  |
| MF-RX050/72 | 0.78                          | 0.68   | 0.60 | 0.50  | 0.41  | 0.36  | 0.32  | 0.27  | 0.20  |
| MF-RX065/72 | 1.01                          | 0.88   | 0.77 | 0.65  | 0.53  | 0.47  | 0.41  | 0.35  | 0.26  |
| MF-RX075/72 | 1.16                          | 1.02   | 0.89 | 0.75  | 0.61  | 0.54  | 0.47  | 0.41  | 0.30  |
| MF-RX090/72 | 1.40                          | 1.22   | 1.07 | 0.90  | 0.73  | 0.65  | 0.57  | 0.49  | 0.36  |
| MF-RX110/72 | 1.71                          | 1.50   | 1.31 | 1.10  | 0.89  | 0.79  | 0.69  | 0.59  | 0.44  |
| MF-RX135/72 | 2.09                          | 1.84   | 1.61 | 1.35  | 1.09  | 0.97  | 0.85  | 0.73  | 0.54  |
| MF-RX160/72 | 2.48                          | 2.18   | 1.90 | 1.60  | 1.30  | 1.15  | 1.01  | 0.86  | 0.64  |
| MF-RX185/72 | 2.87                          | 2.52   | 2.20 | 1.85  | 1.50  | 1.33  | 1.17  | 1.00  | 0.74  |
| MF-RX250/72 | 3.88                          | 3.40   | 2.98 | 2.50  | 2.03  | 1.80  | 1.58  | 1.35  | 1.00  |
| MF-RX300/72 | 4.65                          | 4.08   | 3.57 | 3.00  | 2.43  | 2.16  | 1.89  | 1.62  | 1.20  |
| MF-RX375/72 | 5.81                          | 5.10   | 4.46 | 3.75  | 3.04  | 2.70  | 2.36  | 2.03  | 1.50  |

$I_{trip}$  is approximately two times  $I_{hold}$ .

Specifications are subject to change without notice.

Users should verify actual device performance in their specific applications.

The products described herein and this document are subject to specific legal disclaimers as set forth on the last page of this document, and at [www.bourns.com/docs/legal/disclaimer.pdf](http://www.bourns.com/docs/legal/disclaimer.pdf).

## MF-RX/72 Series - PTC Resettable Fuses

**BOURNS®**

### Packaging Quantity

| Packaging options | Models                    | Unit Quantity (Pcs.) | Unit |
|-------------------|---------------------------|----------------------|------|
| Bulk              | All models                | 500                  | Bag  |
| Tape & Reel       | MF-RX020/72 ~ MF-RX090/72 | 3000                 | Reel |
|                   | MF-RX110/72 ~ MF-RX160/72 | 1500                 |      |
|                   | MF-RX185/72 ~ MF-RX375/72 | 1000                 |      |
| Ammo-Pack         | MF-RX020/72 ~ MF-RX090/72 | 2000                 | Pack |
|                   | MF-RX110/72 ~ MF-RX160/72 | 1000                 |      |
|                   | MF-RX185/72 ~ MF-RX375/72 | 500                  |      |

MF-RX/72 SERIES, REV. R, EFFECTIVE 04/06/20

Specifications are subject to change without notice.

Users should verify actual device performance in their specific applications.

The products described herein and this document are subject to specific legal disclaimers as set forth on the last page of this document, and at [www.bourns.com/docs/legal/disclaimer.pdf](http://www.bourns.com/docs/legal/disclaimer.pdf).

# MF-RX/72 Series Tape and Reel Specifications

**BOURNS®**

Devices taped using EIA-468/IEC 60286-2 standards. See table below and figure for details.

| Dimension Description                                      | IEC Mark   | EIA Mark   | Dimensions                            |                                     |
|--|------------|------------|---------------------------------------|-------------------------------------|
|  |            |            | Dimensions                            | Tolerance                           |
| Carrier tape width   | $W$        | $W$        | $\frac{18}{(.709)}$                   | $\frac{-0.5/+1.0}{(-0.02/+0.039)}$  |
| Hold down tape width                                       | $W_0$      | $W_0$      | $\frac{5}{(.197)}$                    | min.                                |
| Hold down tape   |            |            | No protrusion                         |                                     |
| Adhesive tape position                                     | $W_2$      | $W_2$      | $\frac{3}{(.118)}$                    | max.                                |
| Sprocket hole position                                     | $W_1$      | $W_1$      | $\frac{9}{(.354)}$                    | $\frac{-0.5/+0.75}{(-0.02/+0.03)}$  |
| Sprocket hole diameter                                     | $D_0$      | $D_0$      | $\frac{4}{(.157)}$                    | $\frac{\pm 0.2}{(\pm .0078)}$       |
| Height to seating plane (straight lead)                    | $H$        | $H$        | $\frac{18 \sim 20}{(.709 \sim .787)}$ |                                     |
| Height to seating plane (formed lead)                      | $H_0$      | $H_0$      | $\frac{16}{(.63)}$                    | $\frac{\pm 0.5}{(\pm .02)}$         |
| Overall height above abscissa                              | $H_1$      | $H_1$      | $\frac{38.5}{(1.516)}$                | max.                                |
| Cutout Length  |            | $L$        | $\frac{11}{(.433)}$                   | max.                                |
| Sprocket hole pitch: MF-RX020/72 ~ MF-RX185/72             | $P_0$      | $P_0$      | $\frac{12.7}{(0.5)}$                  | $\frac{\pm 0.3}{(\pm .012)}$        |
| Sprocket hole pitch: MF-RX250/72 ~ MF-RX375/72             | $P_0$      | $P_0$      | $\frac{25.4}{(1.0)}$                  | $\frac{\pm 0.3}{(\pm .012)}$        |
| Device pitch: MF-RX020/72 ~ MF-RX090/72                    | $P$        | $P$        | $\frac{12.7}{(0.5)}$                  | $\frac{\pm 0.3}{(\pm .012)}$        |
| Device pitch: MF-RX110/72 ~ MF-RX375/72                    | $P$        | $P$        | $\frac{25.4}{(1.0)}$                  | $\frac{\pm 0.6}{(\pm .024)}$        |
| Pitch tolerance  |            |            | 20 consecutive                        | $\frac{\pm 1}{(\pm .039)}$          |
| Composite tape thickness                                   | $t$        | $t$        | $\frac{0.9}{(.035)}$                  | max.                                |
| Overall tape and lead thickness: MF-RX020/72 ~ MF-RX090/72 | $t_1$      | $t_1$      | $\frac{2.0}{(0.079)}$                 | max.                                |
| Overall tape and lead thickness: MF-RX110/72 ~ MF-RX375/72 | $t_1$      | $t_1$      | $\frac{2.3}{(0.091)}$                 | max.                                |
| Splice sprocket hole alignment                             |            |            | 0                                     | $\frac{\pm 0.3}{(\pm .012)}$        |
| Front-to-back deviation                                    | $\Delta_h$ | $\Delta_h$ | 0                                     | $\frac{\pm 1.0}{(\pm .039)}$        |
| Side-to-side deviation                                     | $\Delta_p$ | $\Delta_p$ | 0                                     | $\frac{\pm 1.3}{(\pm .051)}$        |
| Ordinate to adjacent component lead                        | $P_1$      | $P_1$      | $\frac{3.81}{(0.150)}$                | $\frac{\pm 0.7}{(\pm 0.028)}$       |
| Lead spacing: MF-RX020/72 ~ MF-RX185/72                    | $F$        | $F$        | $\frac{5.08}{(0.2)}$                  | $\frac{+0.6/-0.2}{(+0.024/-0.008)}$ |
| Lead spacing: MF-RX250/72 ~ MF-RX375/72                    | $F$        | $F$        | $\frac{10.2}{(0.4)}$                  | $\frac{+0.6/-0.2}{(+0.024/-0.008)}$ |

— Continued on next page —

DIMENSIONS:  $\frac{\text{MM}}{\text{(INCHES)}}$

Specifications are subject to change without notice.

Users should verify actual device performance in their specific applications.

The products described herein and this document are subject to specific legal disclaimers as set forth on the last page of this document, and at [www.bourns.com/docs/legal/disclaimer.pdf](http://www.bourns.com/docs/legal/disclaimer.pdf).

# MF-RX/72 Series Tape and Reel Specifications

**BOURNS®**

| Dimension Description                            | IEC Mark | EIA Mark | Dimensions  |                            |
|--|----------|----------|---|----------------------------|
|  |          |          | Dimensions  | Tolerance                  |
| Reel width including flanges and hub             | $W_4$    | $w_2$    | $\frac{62.0}{(2.44)}$   | max.                       |
| Dimension between flanges (measured at hub)      | $W_3$    | $w_1$    | allow proper reeling and unreeling                            |                            |
| Reel diameter                                    | $A$      | $a$      | $\frac{370.0}{(14.57)}$                                       | max.                       |
| Space between flanges (at hub, excluding device) |          |          | $\frac{4.75}{(.187)}$   | $\pm 3.25$<br>$(\pm .128)$ |
| Arbor hole diameter                              | $C$      | $c$      | $\frac{26.0}{(1.024)}$  | $\pm 12.0$<br>$(\pm .472)$ |
| Core diameter                                    | $N$      | $n$      | $\frac{80}{(3.15)}$   | min.                       |
| Box dimensions                                   |          |          | $\frac{62}{(2.44)}$ $\frac{372}{(14.6)}$ $\frac{372}{(14.6)}$ | max.                       |
| Consecutive missing places                       |          |          | 3   | max.                       |
| Empty places per reel                            |          |          | Not specified   |                            |

**Taped Component Dimensions - per EIA Mark - Figure 1**

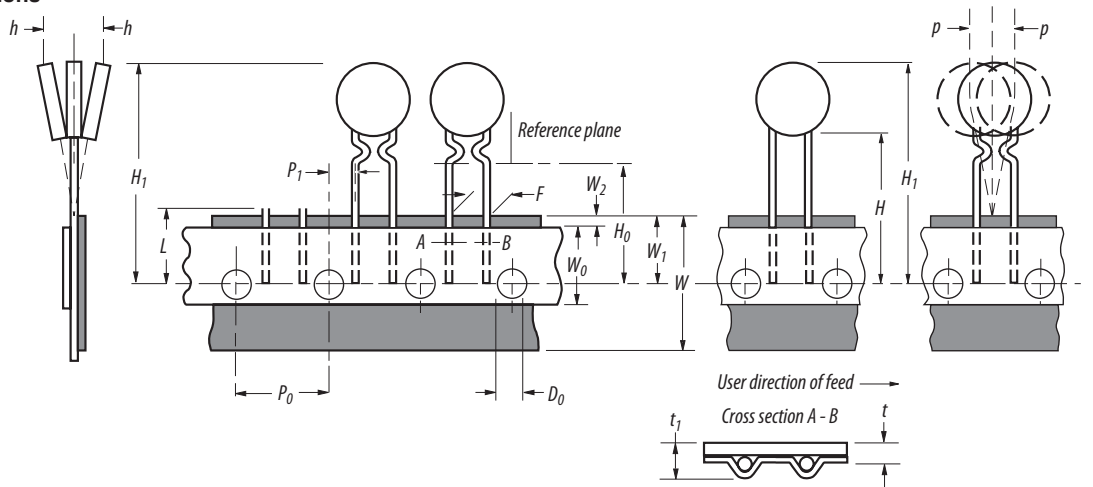

**Reel Dimensions - per EIA Mark - Figure 2**

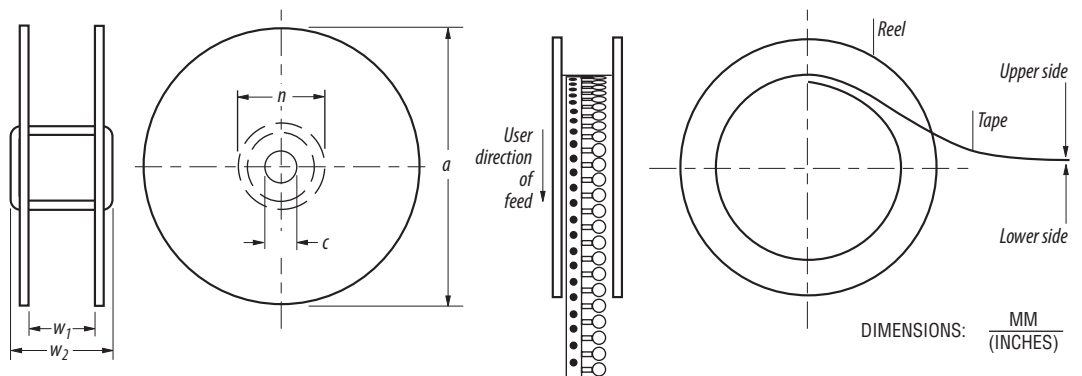

Specifications are subject to change without notice. Users should verify actual device performance in their specific applications. The products described herein and this document are subject to specific legal disclaimers as set forth on the last page of this document, and at [www.bourns.com/docs/legal/disclaimer.pdf](http://www.bourns.com/docs/legal/disclaimer.pdf).

**Application Notice**

- Users are responsible for independent and adequate evaluation of Bourns® Multifuse® Polymer PTC devices in the user's application, including the PPTC device characteristics stated in the applicable data sheet.
- Polymer PTC devices must not be allowed to operate beyond their stated maximum ratings. Operation in excess of such maximum ratings could result in damage to the PTC device and possibly lead to electrical arcing and/or fire. Circuits with inductance may generate a voltage above the rated voltage of the polymer PTC device and should be thoroughly evaluated within the user's application during the PTC selection and qualification process.
- Polymer PTC devices are intended to protect against adverse effects of temporary overcurrent or overtemperature conditions up to rated limits and are not intended to serve as protective devices where overcurrent or overvoltage conditions are expected to be repetitive or prolonged.
- In normal operation, polymer PTC devices experience thermal expansion under fault conditions. Thus, a polymer PTC device must be protected against mechanical stress, and must be given adequate clearance within the user's application to accommodate such thermal expansion. Rigid potting materials or fixed housings or coverings that do not provide adequate clearance should be thoroughly examined and tested by the user, as they may result in the malfunction of polymer PTC devices if the thermal expansion is inhibited.
- Exposure to lubricants, silicon-based oils, solvents, gels, electrolytes, acids, and other related or similar materials may adversely affect the performance of polymer PTC devices.
- Aggressive solvents may adversely affect the performance of polymer PTC devices. Conformal coating, encapsulating, potting, molding, and sealing materials may contain aggressive solvents including but not limited to xylene and toluene, which are known to cause adverse effects on the performance of polymer PTCs. Such aggressive solvents must be thoroughly cured or baked to ensure their complete removal from polymer PTCs to minimize the possible adverse effect on the device.
- Recommended storage conditions should be followed at all times. Such conditions can be found on the applicable data sheet and on the Multifuse® Polymer PTC Moisture/Reflow Sensitivity Classification (MSL) note:  
[https://www.bourns.com/docs/RoHS-MSL/msl\\_mf.pdf](https://www.bourns.com/docs/RoHS-MSL/msl_mf.pdf)