





Features

- 72 V rated
- Cured, flame retardant epoxy polymer insulating material meets UL 94 V-0 requirements
- RoHS compliant* and halogen free**
- Agency recognition:  

Applications

Almost anywhere there is a low voltage power supply, up to 72 V and a load to be protected, including:

- Security and fire alarm systems
- Loudspeakers
- Power transformers

MF-RX/72 Series - PTC Resettable Fuses

Electrical Characteristics

Model	V _{max}	I _{max}	I _{hold}	I _{trip}	Initial Resistance		1 Hour (R ₁) Post-Trip Resistance	Max. Time to Trip		Tripped Power Dissipation	Agency Recognition	
			at 23 °C		at 23 °C Ohms		at 23 °C Ohms	at 23 °C		at 23 °C Watts	cUL	TÜV
	Volts	Amps	Amps		Min.	Max.	Max.	Amps	Seconds	Typ.	E174545	R50366745
MF-RX020/72	72	40	0.20	0.40	1.50	2.84	4.40	1.00	2.2	0.40	✓	✓
MF-RX025/72	72	40	0.25	0.50	1.00	1.95	3.00	1.25	2.5	0.45	✓	✓
MF-RX030/72	72	40	0.30	0.60	0.76	1.36	2.10	1.50	3.0	0.50	✓	✓
MF-RX040/72	72	40	0.40	0.80	0.52	0.86	1.29	2.00	3.9	0.55	✓	✓
MF-RX050/72	72	40	0.50	1.00	0.41	0.77	1.17	2.50	4.0	0.75	✓	✓
MF-RX065/72	72	40	0.65	1.30	0.27	0.48	0.72	3.25	5.3	0.90	✓	✓
MF-RX075/72	72	40	0.75	1.50	0.18	0.40	0.60	3.75	6.3	0.90	✓	✓
MF-RX090/72	72	40	0.90	1.80	0.14	0.31	0.47	4.50	7.2	1.00	✓	✓
MF-RX110/72	72	40	1.10	2.20	0.15	0.25	0.38	5.50	8.2	1.50	✓	✓
MF-RX135/72	72	40	1.35	2.70	0.12	0.19	0.30	6.75	9.6	1.70	✓	✓
MF-RX160/72	72	40	1.60	3.20	0.09	0.14	0.22	8.00	11.4	1.90	✓	✓
MF-RX185/72	72	40	1.85	3.70	0.08	0.12	0.19	9.25	12.6	2.10	✓	✓
MF-RX250/72	72	40	2.50	5.00	0.05	0.08	0.13	12.50	15.6	2.50	✓	✓
MF-RX300/72	72	40	3.00	6.00	0.04	0.06	0.10	15.00	19.8	2.80	✓	✓
MF-RX375/72	72	40	3.75	7.50	0.03	0.05	0.08	18.75	24.0	3.20	✓	✓

Environmental Characteristics

Item	Condition	Criteria
Operating Temperature	-40 °C to +85 °C	
Recommended Storage	+40 °C max. / 70 % R.H. max.	
Passive Aging	+85 °C, 1000 hours	±5 % typical resistance change
Humidity Aging	+85 °C, 85 % R.H. 1000 hours	±5 % typical resistance change
Thermal Shock	-40 °C to +85 °C, 10 times	±10 % typical resistance change
Solvent Resistance	MIL-STD-202, Method 215	No change (marking still legible)
Vibration	MIL-STD-883C, Method 2007.1 Condition A	No change (R _{min} < R < R _{1max})
Moisture Sensitivity Level (MSL)	See Note	
ESD Classification	Class 6 (per AEC-Q200-2, HBM)	

Additional Information

Click these links for more information:



BOURNS®

Asia-Pacific: Tel: +886-2 2562-4117

Email: asiacus@bourns.com

EMEA: Tel: +36 88 885 877

Email: eurocus@bourns.com

The Americas: Tel: +1-951 781-5500

Email: americus@bourns.com

www.bourns.com

* RoHS Directive 2015/863, Mar 31, 2015 and Annex.

** Bourns considers a product to be "halogen free" if (a) the Bromine (Br) content is 900 ppm or less; (b) the Chlorine (Cl) content is 900 ppm or less; and (c) the total Bromine (Br) and Chlorine (Cl) content is 1500 ppm or less.

Specifications are subject to change without notice. Users should verify actual device performance in their specific applications. The products described herein and this document are subject to specific legal disclaimers as set forth on the last page of this document, and at www.bourns.com/docs/legal/disclaimer.pdf.



WARNING
Cancer and Reproductive Harm
www.P65Warnings.ca.gov

MF-RX/72 Series - PTC Resettable Fuses

BOURNS®

Product Dimensions

Model	A		B		C		D		E		Physical Characteristics		
	Max.	Max.	Nom.	Tol. ±	Min.	Max.	Style	Lead Dia.	Material				
MF-RX020/72	7.4 (0.291)	12.7 (0.5)	5.1 (0.201)	0.7 (0.028)	7.6 (0.30)	3.1 (0.122)	1	0.51 (0.020)	Sn/CuFe				
MF-RX025/72	7.4 (0.291)	12.7 (0.5)	5.1 (0.201)	0.7 (0.028)	7.6 (0.30)	3.1 (0.122)	1	0.51 (0.020)	Sn/CuFe				
MF-RX030/72	7.4 (0.291)	13.4 (0.528)	5.1 (0.201)	0.7 (0.028)	7.6 (0.30)	3.1 (0.122)	1	0.51 (0.020)	Sn/CuFe				
MF-RX040/72	7.4 (0.291)	13.7 (0.539)	5.1 (0.201)	0.7 (0.028)	7.6 (0.30)	3.1 (0.122)	1	0.51 (0.020)	Sn/CuFe				
MF-RX050/72	7.9 (0.311)	13.7 (0.539)	5.1 (0.201)	0.7 (0.028)	7.6 (0.30)	3.1 (0.122)	1	0.51 (0.020)	Sn/Cu				
MF-RX065/72	9.7 (0.382)	15.2 (0.598)	5.1 (0.201)	0.7 (0.028)	7.6 (0.30)	3.1 (0.122)	1	0.51 (0.020)	Sn/Cu				
MF-RX075/72	10.4 (0.409)	16.0 (0.630)	5.1 (0.201)	0.7 (0.028)	7.6 (0.30)	3.1 (0.122)	1	0.51 (0.020)	Sn/Cu				
MF-RX090/72	11.7 (0.461)	16.70 (0.657)	5.1 (0.201)	0.7 (0.028)	7.6 (0.30)	3.1 (0.122)	1	0.51 (0.020)	Sn/Cu				
MF-RX110/72	10.84 (0.427)	16.84 (0.663)	5.1 (0.201)	0.7 (0.028)	7.6 (0.30)	3.1 (0.122)	2	0.81 (0.032)	Sn/Cu				
MF-RX135/72	12.26 (0.483)	18.26 (0.719)	5.1 (0.201)	0.7 (0.028)	7.6 (0.30)	3.1 (0.122)	2	0.81 (0.032)	Sn/Cu				
MF-RX160/72	13.94 (0.549)	19.94 (0.785)	5.1 (0.201)	0.7 (0.028)	7.6 (0.30)	3.1 (0.122)	2	0.81 (0.032)	Sn/Cu				
MF-RX185/72	15.18 (0.598)	21.18 (0.834)	5.1 (0.201)	0.7 (0.028)	7.6 (0.30)	3.1 (0.122)	2	0.81 (0.032)	Sn/Cu				
MF-RX250/72	17.84 (0.702)	23.84 (0.939)	10.2 (0.402)	0.7 (0.028)	7.6 (0.30)	3.1 (0.122)	2	0.81 (0.032)	Sn/Cu				
MF-RX300/72	20.67 (0.814)	26.67 (1.050)	10.2 (0.402)	0.7 (0.028)	7.6 (0.30)	3.1 (0.122)	2	0.81 (0.032)	Sn/Cu				
MF-RX375/72	23.51 (0.926)	29.51 (1.162)	10.2 (0.402)	0.7 (0.028)	7.6 (0.30)	3.1 (0.122)	2	0.81 (0.032)	Sn/Cu				

DIMENSIONS: $\frac{MM}{(INCHES)}$

Style 1

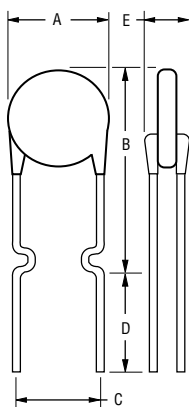

Style 2

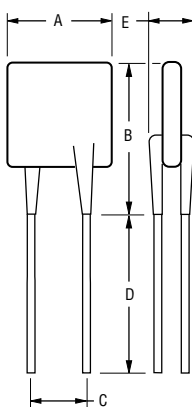

Also available with kinked and straight leads in place of standard leads (see How to Order).

How to Order

MF - RX 110/72 - 2 - 14

Multifuse®
Product Designator

Series
RX = Radial Leaded Component

Hold Current, I_{hold}
020-375 (0.20 A - 3.75 A)

Maximum Voltage, V_{max}
72 (72 Volts)

Packaging Options
- 0 = Bulk Packaging
- 2 = Tape and Reel*
- AP = Ammo-Pak*

Part Number Suffix Option
- 14 = Kinked Leads in Place of Standard Straight Leads
- 17 = Straight Leads in Place of Standard Kinked Leads

*Packaged per EIA-468

Typical Part Marking

Represents total content. Layout may vary.

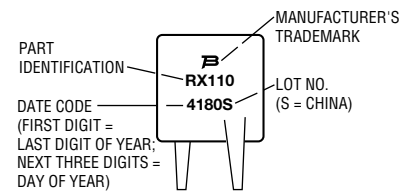

Specifications are subject to change without notice. Users should verify actual device performance in their specific applications.

The products described herein and this document are subject to specific legal disclaimers as set forth on the last page of this document, and at www.bourns.com/docs/legal/disclaimer.pdf.

MF-RX/72 Series - PTC Resettable Fuses

BOURNS®

Test Procedures and Requirements

Item	Test Conditions	Accept/Reject Criteria
Visual/Mechanical	Verify dimensions and materials	Per MF physical description
Resistance	In still air @ 23 °C	$R_{min} \leq R \leq R_{max}$
Time to Trip	5 times I_{hold} , V_{max} , 23 °C	$T \leq \text{max. time to trip (seconds)}$
Hold Current	30 min. at I_{hold}	No trip
Trip Cycle Life	V_{max} , I_{max} , 100 cycles	No arcing or burning
Trip Endurance	V_{max} , 48 hours	No arcing or burning
Solderability	245 °C \pm 5 °C, 5 seconds	95 % min. coverage

Typical Time to Trip at 23 °C

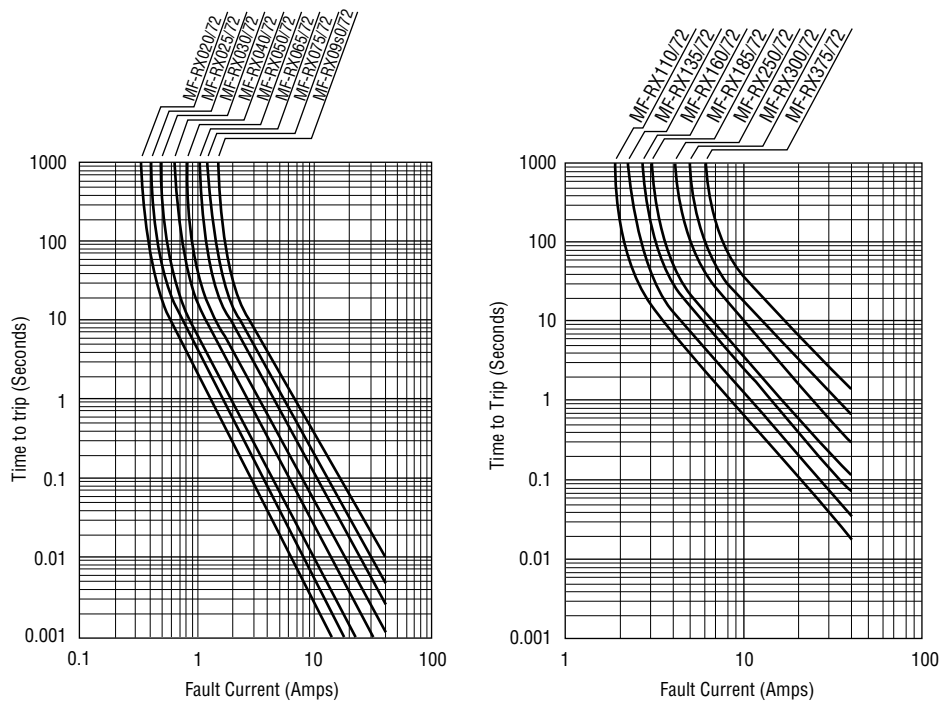

The Time to Trip curves represent typical performance of a device in a simulated application environment. Actual performance in specific customer applications may differ from these values due to the influence of other variables.

Specifications are subject to change without notice.

Users should verify actual device performance in their specific applications.

The products described herein and this document are subject to specific legal disclaimers as set forth on the last page of this document, and at www.bourns.com/docs/legal/disclaimer.pdf.

MF-RX/72 Series - PTC Resettable Fuses



Thermal Derating Table - I_{hold} (Amps)

Model	Ambient Operating Temperature								
	-40 °C	-20 °C	0 °C	23 °C	40 °C	50 °C	60 °C	70 °C	85 °C
MF-RX020/72	0.31	0.27	0.24	0.20	0.16	0.14	0.13	0.11	0.08
MF-RX025/72	0.39	0.34	0.30	0.25	0.20	0.18	0.16	0.14	0.10
MF-RX030/72	0.47	0.41	0.36	0.30	0.24	0.22	0.19	0.16	0.12
MF-RX040/72	0.62	0.54	0.48	0.40	0.32	0.29	0.25	0.22	0.16
MF-RX050/72	0.78	0.68	0.60	0.50	0.41	0.36	0.32	0.27	0.20
MF-RX065/72	1.01	0.88	0.77	0.65	0.53	0.47	0.41	0.35	0.26
MF-RX075/72	1.16	1.02	0.89	0.75	0.61	0.54	0.47	0.41	0.30
MF-RX090/72	1.40	1.22	1.07	0.90	0.73	0.65	0.57	0.49	0.36
MF-RX110/72	1.71	1.50	1.31	1.10	0.89	0.79	0.69	0.59	0.44
MF-RX135/72	2.09	1.84	1.61	1.35	1.09	0.97	0.85	0.73	0.54
MF-RX160/72	2.48	2.18	1.90	1.60	1.30	1.15	1.01	0.86	0.64
MF-RX185/72	2.87	2.52	2.20	1.85	1.50	1.33	1.17	1.00	0.74
MF-RX250/72	3.88	3.40	2.98	2.50	2.03	1.80	1.58	1.35	1.00
MF-RX300/72	4.65	4.08	3.57	3.00	2.43	2.16	1.89	1.62	1.20
MF-RX375/72	5.81	5.10	4.46	3.75	3.04	2.70	2.36	2.03	1.50

I_{trip} is approximately two times I_{hold}.

Packaging Quantity

Packaging options	Models	Unit Quantity (Pcs.)	Unit
Bulk	All models	500	Bag
Tape & Reel	MF-RX020/72 ~ MF-RX090/72	3000	Reel
	MF-RX110/72 ~ MF-RX160/72	1500	
	MF-RX185/72 ~ MF-RX375/72	1000	
Ammo-Pack	MF-RX020/72 ~ MF-RX090/72	2000	Pack
	MF-RX110/72 ~ MF-RX160/72	1000	
	MF-RX185/72 ~ MF-RX375/72	500	

Specifications are subject to change without notice.

Users should verify actual device performance in their specific applications.

The products described herein and this document are subject to specific legal disclaimers as set forth on the last page of this document, and at www.bourns.com/docs/legal/disclaimer.pdf.

MF-RX/72 Series Tape and Reel Specifications

BOURNS®

Devices taped using EIA-468/IEC 60286-2 standards. See table below and figures for details.

Dimension Description	IEC Mark	EIA Mark	Dimensions	Tolerance
Carrier tape width	W	W	$\frac{18}{(.709)}$	$\frac{+1.0/-0.5}{(+.039/- .020)}$
Hold down tape width	W_0	W_0	$\frac{5}{(.197)}$	min.
Hold down tape	No protrusion			
Adhesive tape position	W_2	W_2	$\frac{3}{(.118)}$	max.
Sprocket hole position	W_1	W_1	$\frac{9}{(.354)}$	$\frac{+0.75/-0.5}{(+.030/- .020)}$
Sprocket hole diameter	D_0	D_0	$\frac{4}{(.157)}$	$\frac{\pm 0.2}{(\pm .0078)}$
Height to seating plane (straight lead)	H	H	$\frac{18 \sim 20}{(.709 \sim .787)}$	
Height to seating plane (formed lead)	H_0	H_0	$\frac{16}{(.630)}$	$\frac{\pm 0.5}{(\pm .020)}$
Overall height above abscissa	H_1	H_1	$\frac{38.5}{(1.516)}$	max.
Cutout length		L	$\frac{11}{(.433)}$	max.
Sprocket hole pitch: MF-RX020/72 ~ MF-RX185/72	P_0	P_0	$\frac{12.7}{(.500)}$	$\frac{\pm 0.3}{(\pm .012)}$
Sprocket hole pitch: MF-RX250/72 ~ MF-RX375/72	P_0	P_0	$\frac{25.4}{(1.00)}$	$\frac{\pm 0.3}{(\pm .012)}$
Device pitch: MF-RX020/72 ~ MF-RX090/72	P	P	$\frac{12.7}{(.500)}$	$\frac{\pm 0.3}{(\pm .012)}$
Device pitch: MF-RX110/72 ~ MF-RX185/72	P	P	$\frac{25.4}{(1.00)}$	$\frac{\pm 0.6}{(\pm .024)}$
Device pitch: MF-RX250/72 ~ MF-RX375/72	P	P	$\frac{30.0}{(1.181)}$	$\frac{\pm 0.6}{(\pm .024)}$
Pitch tolerance			20 consecutive	$\frac{\pm 1}{(\pm .039)}$
Composite tape thickness	t	t	$\frac{0.9}{(.035)}$	max.
Overall tape and lead thickness: MF-RX020/72 ~ MF-RX090/72	t_1	t_1	$\frac{2.0}{(.079)}$	max.
Overall tape and lead thickness: MF-RX110/72 ~ MF-RX375/72	t_1	t_1	$\frac{2.3}{(.091)}$	max.
Splice sprocket hole alignment			0	$\frac{\pm 0.3}{(\pm .012)}$
Front-to-back deviation	Δ_h	Δ_h	0	$\frac{\pm 1.0}{(\pm .039)}$
Side-to-side deviation	Δ_p	Δ_p	0	$\frac{\pm 1.3}{(\pm .051)}$
Ordinate to adjacent component lead: MF-RX020/72 ~ MF-RX185/72	P_1	P_1	$\frac{3.81}{(.150)}$	$\frac{\pm 0.7}{(\pm .028)}$
Ordinate to adjacent component lead: MF-RX250/72 ~ MF-RX375/72	P_1	P_1	$\frac{9.9}{(.390)}$	$\frac{\pm 0.7}{(\pm .028)}$
Lead spacing: MF-RX020/72 ~ MF-RX185/72	F	F	$\frac{5.08}{(.200)}$	$\frac{+0.6/-0.2}{(+.024/- .008)}$
Lead spacing: MF-RX250/72 ~ MF-RX375/72	F	F	$\frac{10.2}{(.400)}$	$\frac{+0.6/-0.2}{(+.024/- .008)}$

— Continued on next page —

DIMENSIONS: $\frac{\text{MM}}{\text{(INCHES)}}$

Specifications are subject to change without notice.

Users should verify actual device performance in their specific applications.

The products described herein and this document are subject to specific legal disclaimers as set forth on the last page of this document, and at www.bourns.com/docs/legal/disclaimer.pdf.

MF-RX/72 Series Tape and Reel Specifications

BOURNS®

Devices taped using EIA-468/IEC 60286-2 standards. See table below and figures for details.

Dimension Description	IEC Mark	EIA Mark	Dimensions	Tolerance
Reel width including flanges and hub	W_4	w_2	$\frac{62.0}{(2.44)}$	max
Dimension between flanges (measured at hub)	W_3	w_1	allow proper reeling and unreeling	
Reel diameter	A	a	$\frac{370.0}{(14.57)}$	max.
Space between flanges (at hub, excluding device)			$\frac{4.75}{(.187)}$	± 3.25 ($\pm .128$)
Arbor hole diameter	C	c	$\frac{26.0}{(1.024)}$	± 12.0 ($\pm .472$)
Core diameter	N	n	$\frac{80}{(3.15)}$	min.
Box dimensions			$\frac{62 \times 372 \times 372}{(2.44 \times 14.6 \times 14.6)}$	max.
Consecutive missing places			3	max.
Empty places per reel			Less than 0.1 %	

Taped Component Dimensions - per EIA Mark - Figure 1

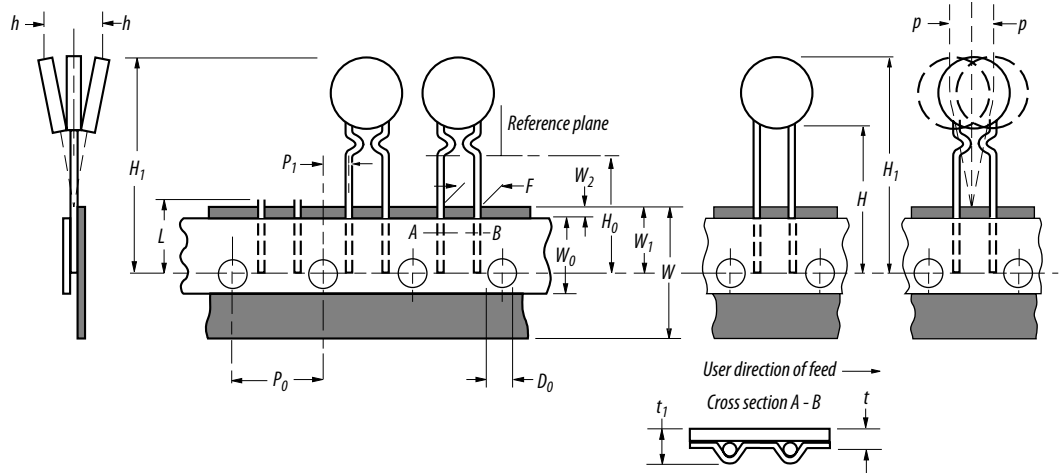

Reel Dimensions - per EIA Mark - Figure 2

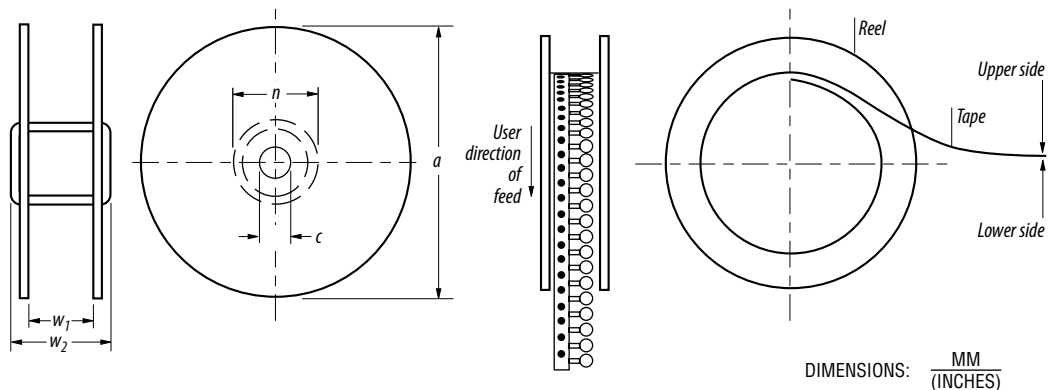

DIMENSIONS: $\frac{\text{MM}}{\text{(INCHES)}}$

MF-RX/72 SERIES, REV. S, EFFECTIVE 06/21

Specifications are subject to change without notice.

Users should verify actual device performance in their specific applications.

The products described herein and this document are subject to specific legal disclaimers as set forth on the last page of this document, and at www.bourns.com/docs/legal/disclaimer.pdf.

Application Notice

- Users are responsible for independent and adequate evaluation of Bourns® Multifuse® Polymer PTC devices in the user's application, including the PPTC device characteristics stated in the applicable data sheet.
- Polymer PTC devices must not be allowed to operate beyond their stated maximum ratings. Operation in excess of such maximum ratings could result in damage to the PTC device and possibly lead to electrical arcing and/or fire. Circuits with inductance may generate a voltage above the rated voltage of the polymer PTC device and should be thoroughly evaluated within the user's application during the PTC selection and qualification process.
- Polymer PTC devices are intended to protect against adverse effects of temporary overcurrent or overtemperature conditions up to rated limits and are not intended to serve as protective devices where overcurrent or overvoltage conditions are expected to be repetitive or prolonged.
- In normal operation, polymer PTC devices experience thermal expansion under fault conditions. Thus, a polymer PTC device must be protected against mechanical stress, and must be given adequate clearance within the user's application to accommodate such thermal expansion. Rigid potting materials or fixed housings or coverings that do not provide adequate clearance should be thoroughly examined and tested by the user, as they may result in the malfunction of polymer PTC devices if the thermal expansion is inhibited.
- Exposure to lubricants, silicon-based oils, solvents, gels, electrolytes, acids, and other related or similar materials may adversely affect the performance of polymer PTC devices.
- Aggressive solvents may adversely affect the performance of polymer PTC devices. Conformal coating, encapsulating, potting, molding, and sealing materials may contain aggressive solvents including but not limited to xylene and toluene, which are known to cause adverse effects on the performance of polymer PTCs. Such aggressive solvents must be thoroughly cured or baked to ensure their complete removal from polymer PTCs to minimize the possible adverse effect on the device.
- Recommended storage conditions should be followed at all times. Such conditions can be found on the applicable data sheet and on the Multifuse® Polymer PTC Moisture/Reflow Sensitivity Classification (MSL) note:
https://www.bourns.com/docs/RoHS-MSL/msl_mf.pdf