





Features

- Surface mount packaging for automated assembly
- Small footprint size (1210) and low profile for space-constrained mobile applications
- Ultra-low resistance, quick response
- RoHS compliant*
- Agency recognition:  

Additional Information

Click these links for more information:



MF-USML/X Series - Low Ohmic PTC Resettable Fuses

Electrical Characteristics

Model	V _{max} Volts	I _{max} Amps	I _{hold}	I _{trip}	Resistance		Max. Time To Trip		Tripped Power Dissipation	Agency Recognition	
			at 23 °C		at 23 °C Ohms		at 23 °C		Watts at 23 °C	cUL	TÜV
			Amps	Amps	R _{min}	R _{1max}	Amps	Seconds	Typ.	E174545	R50391579
MF-USML175/6	6	50	1.75	3.5	0.006	0.05	8	0.8	1.0	✓	✓
MF-USML175/12	12	50	1.75	3.5	0.006	0.05	8	0.8	1.0	✓	✓
MF-USML200/6	6	50	2.0	4.0	0.005	0.04	8	5	1.0	✓	✓
MF-USML200/12	12	50	2.0	4.0	0.005	0.04	8	5	1.0	✓	✓
MF-USML260/6	6	50	2.6	5.2	0.004	0.03	8	5	1.0	✓	✓
MF-USML260/12	12	50	2.6	5.2	0.004	0.03	8	5	1.0	✓	✓
MF-USML300/6	6	50	3.0	6.0	0.003	0.024	15	5	1.0	✓	✓
MF-USML300/12	12	50	3.0	6.0	0.003	0.024	15	5	1.0	✓	✓
MF-USML350/6	6	50	3.5	7.0	0.002	0.022	17	5	1.0	✓	✓
MF-USML350/12	12	50	3.5	7.0	0.002	0.022	17	5	1.0	✓	✓
MF-USML380/6	6	50	3.8	7.6	0.002	0.02	19	5	1.0	✓	✓
MF-USML380/12	12	50	3.8	7.6	0.002	0.02	19	5	1.0	✓	✓
MF-USML400/6	6	50	4.0	8.0	0.002	0.018	20	5	1.0	✓	✓
MF-USML400/12	12	50	4.0	8.0	0.002	0.018	20	5	1.0	✓	✓
MF-USML450/6	6	50	4.5	9.0	0.002	0.014	22.5	2	1.0	✓	✓
MF-USML450/12	12	50	4.5	9.0	0.002	0.014	22.5	2	1.0	✓	✓
MF-USML500/6	6	50	5.0	10	0.001	0.012	25	2	1.2	✓	✓
MF-USML500/12	12	50	5.0	10	0.001	0.012	25	2	1.2	✓	✓
MF-USML550/6	6	50	5.5	11	0.001	0.01	27.5	2	1.2	✓	✓
MF-USML550/12	12	50	5.5	11	0.001	0.01	27.5	2	1.2	✓	✓
MF-USML600/6	6	50	6.0	12	0.001	0.01	30	2	1.2	✓	✓
MF-USML650/6	6	50	6.5	13	0.001	0.009	32.5	2	1.2	✓	✓
MF-USML700/6	6	50	7.0	14	0.001	0.008	35	2	1.2	✓	✓

Environmental Characteristics

Item	Condition	Criteria
Operating Temperature	-40 °C to +85 °C	
Storage Condition	Before Opening	+40 °C max. / 70 % RH max.
	After Opening	+40 °C max. / 10 % RH max.
Floor Condition After Opening	Consumption within 4 weeks at floor condition +30 °C max. / 60 % RH max.	
Passive Aging	+85 °C, 1000 hours	±10 % typical resistance change
Humidity Aging	+85 °C, 85 % R.H. 100 hours	±15 % typical resistance change
Thermal Shock	-40 °C to +85 °C, 20 times	±30 % typical resistance change
Solvent Resistance	MIL-STD-202, Method 215	No change (marking still legible)
Vibration	MIL-STD-883C, Method 2007.1 Condition A	No change (R _{min} < R < R _{1max})
Moisture Sensitivity Level (MSL)	See Note	
ESD Classification	Class 6 (per AEC-Q200-2, HBM)	



WARNING
Cancer and Reproductive Harm
www.P65Warnings.ca.gov

* RoHS Directive 2015/863, Mar 31, 2015 and Annex.
** Bourns considers a product to be "halogen free" if (a) the Bromine (Br) content is 900 ppm or less; (b) the Chlorine (Cl) content is 900 ppm or less; and (c) the total Bromine (Br) and Chlorine (Cl) content is 1500 ppm or less.

Specifications are subject to change without notice. Users should verify actual device performance in their specific applications. The products described herein and this document are subject to specific legal disclaimers as set forth on the last page of this document, and at www.bourns.com/docs/legal/disclaimer.pdf.

MF-USML/X Series - Low Ohmic PTC Resettable Fuses



Test Procedures and Requirements

Item	Test Condition	Accept/Reject Criteria
Visual/Mechanical	Verify dimensions and materials	Per MF physical description
Resistance	In still air @ 23 °C	$R_{min} \leq R \leq R_{max}$
Time to Trip	At specified current, V_{max} , 23 °C, still air	$T \leq$ max. time to trip (seconds)
Hold Current	30 min. at I_{hold} , still air	No trip
Trip Cycle Life	V_{max} , I_{max} , 100 cycles	No arcing or burning
Trip Endurance	V_{max} , 48 hours	No arcing or burning
Solderability	245 °C \pm 5 °C, 5 seconds	95 % min. coverage

Product Dimensions

Model	A		B		C		D	E	
	Min.	Max.	Min.	Max.	Min.	Max.		Min.	Max.
MF-USML175/6	3.0 (.118)	3.43 (.135)	2.35 (.093)	2.8 (.110)	0.4 (.016)	0.70 (.028)	0.25 (.010)	0.05 (.002)	0.45 (.018)
MF-USML175/12									
MF-USML200/6									
MF-USML200/12									
MF-USML260/6									
MF-USML260/12									
MF-USML300/6									
MF-USML300/12									
MF-USML350/6									
MF-USML350/12									
MF-USML380/6									
MF-USML380/12									
MF-USML400/6									
MF-USML400/12									
MF-USML450/6									
MF-USML450/12									
MF-USML500/6									
MF-USML500/12									
MF-USML550/6									
MF-USML550/12									
MF-USML600/6	3.0 (.118)	3.43 (.135)	2.35 (.093)	2.8 (.110)	0.6 (.024)	0.95 (.037)			
MF-USML650/6									
MF-USML650/12									
MF-USML700/6									

DIMENSIONS: $\frac{MM}{(INCHES)}$

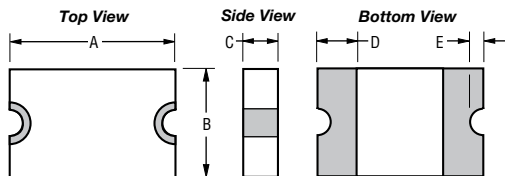

Terminal material:
ENIG-plated terminals

Recommended Pad Layout

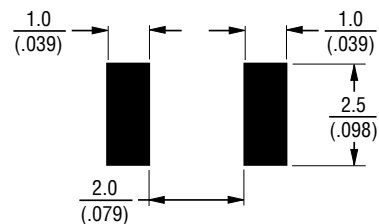

Specifications are subject to change without notice.
Users should verify actual device performance in their specific applications.
The products described herein and this document are subject to specific legal disclaimers as set forth on the last page of this document, and at www.bourns.com/docs/legal/disclaimer.pdf.

MF-USML/X Series - Low Ohmic PTC Resettable Fuses



Packaging Quantity

MF-USML175/6 ~ MF-USML260/6 = 5000 pcs. per reel
 MF-USML175/12 ~ MF-USML260/12 = 5000 pcs. per reel

MF-USML300/6 ~ MF-USML700/6 = 3500 pcs. per reel
 MF-USML300/12 ~ MF-USML550/12 = 3500 pcs. per reel

Thermal Derating Table - I_{hold} (Amps)

Model	Ambient Operating Temperature								
	-40 °C	-20 °C	0 °C	23 °C	40 °C	50 °C	60 °C	70 °C	85 °C
MF-USML175/6	2.57	2.33	2.07	1.75	1.49	1.34	1.24	1.0	0.88
MF-USML175/12	2.57	2.33	2.07	1.75	1.49	1.34	1.24	1.0	0.88
MF-USML200/6	2.94	2.65	2.35	2.0	1.7	1.53	1.42	1.14	1.0
MF-USML200/12	2.94	2.65	2.35	2.0	1.7	1.53	1.42	1.14	1.0
MF-USML260/6	3.82	3.46	3.07	2.6	2.21	1.95	1.85	1.48	1.3
MF-USML260/12	3.82	3.46	3.07	2.6	2.21	1.95	1.85	1.48	1.3
MF-USML300/6	4.41	3.99	3.54	3.0	2.55	2.3	2.13	1.71	1.5
MF-USML300/12	4.41	3.99	3.54	3.0	2.55	2.3	2.13	1.71	1.5
MF-USML350/6	5.1	4.65	4.13	3.5	2.98	2.65	2.5	2.0	1.75
MF-USML350/12	5.1	4.65	4.13	3.5	2.98	2.65	2.5	2.0	1.75
MF-USML380/6	5.59	5.05	4.48	3.8	3.23	2.95	2.7	2.17	1.9
MF-USML380/12	5.59	5.05	4.48	3.8	3.23	2.95	2.7	2.17	1.9
MF-USML400/6	5.8	5.25	4.7	4.0	3.4	3.1	2.8	2.28	2.0
MF-USML400/12	5.8	5.25	4.7	4.0	3.4	3.1	2.8	2.28	2.0
MF-USML450/6	6.3	5.65	4.95	4.5	3.83	3.4	2.95	2.5	2.05
MF-USML450/12	6.3	5.65	4.95	4.5	3.83	3.4	2.95	2.5	2.05
MF-USML500/6	7.0	6.25	5.5	5.0	4.25	3.75	3.25	2.75	2.25
MF-USML500/12	7.0	6.25	5.5	5.0	4.25	3.75	3.25	2.75	2.25
MF-USML550/6	7.7	6.9	6.05	5.5	4.68	4.15	3.6	3.05	2.4
MF-USML550/12	7.7	6.9	6.05	5.5	4.68	4.15	3.6	3.05	2.4
MF-USML600/6	8.4	7.5	6.6	6.0	5.1	4.5	3.9	3.3	2.65
MF-USML650/6	9.1	8.15	7.15	6.5	5.5	4.9	4.25	3.6	2.85
MF-USML700/6	9.8	8.75	7.7	7.0	5.95	5.25	4.55	3.85	3.05

Specifications are subject to change without notice.

Users should verify actual device performance in their specific applications.

The products described herein and this document are subject to specific legal disclaimers as set forth on the last page of this document, and at www.bourns.com/docs/legal/disclaimer.pdf.

Typical Time to Trip at 23 °C

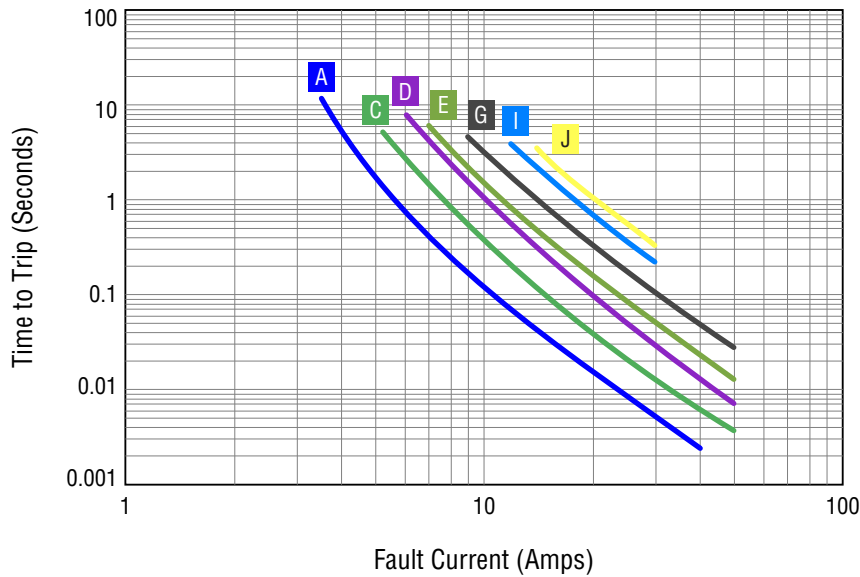

- A** MF-USML175/6 & MF-USML175/12
- C** MF-USML260/6 & MF-USML260/12
- D** MF-USML300/6 & MF-USML300/12
- E** MF-USML350/6 & MF-USML350/12
- G** MF-USML450/6 & MF-USML450/12
- I** MF-USML600/6 & MF-USML650/6
- J** MF-USML700/6

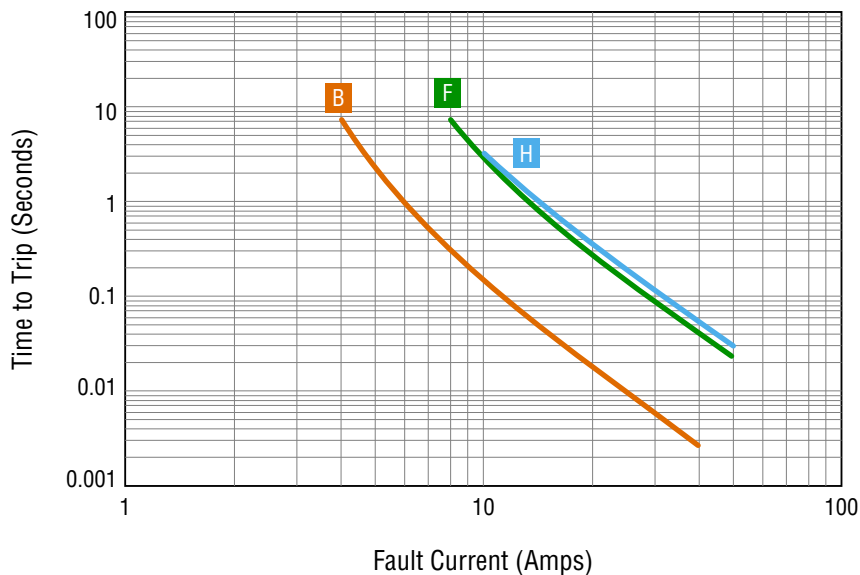

- B** MF-USML200/6 & MF-USML200/12
- F** MF-USML380/6, MF-USML380/12,
MF-USML400/6 & MF-USML400/12
- H** MF-USML500/6, MF-USML500/12,
MF-USML550/6 & MF-USML550/12

The Time to Trip curves represent typical performance of a device in a simulated application environment.

Actual performance in specific customer applications may differ from these values due to the influence of other variables

Specifications are subject to change without notice.

Users should verify actual device performance in their specific applications.

The products described herein and this document are subject to specific legal disclaimers as set forth on the last page of this document, and at www.bourns.com/docs/legal/disclaimer.pdf.

MF-USML/X Series - Low Ohmic PTC Resettable Fuses



Solder Reflow Recommendations

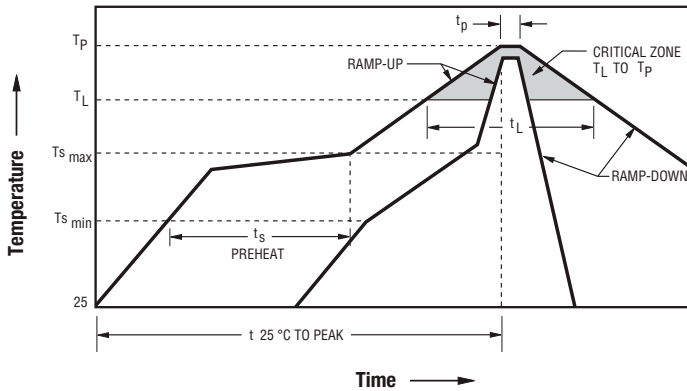

Notes:

- MF-USML/X models are intended for reflow soldering (including, but not limited to heating plate, hot air, IR, nitrogen, and vapor phase).
- Wave soldering is permissible only if the device is on the top of the PCB, opposite the heat source.
- Hand soldering is not recommended for these devices.
- All temperatures refer to the topside of the device, measured on the device body surface.
- If reflow temperatures exceed the recommended profile, devices may not meet the published specifications.
- Compatible with Pb and Pb-free solder reflow profiles.
- Excess solder may cause a short circuit.
- Please refer to the [Multifuse® Polymer PTC Resettable Fuse Soldering Recommendations](#) document for more detail

Profile Feature	Pb-Free Assembly
Average Ramp-Up Rate ($T_{s_{max}}$ to T_p)	3 °C / second max.
PREHEAT: Temperature Min. ($T_{s_{min}}$) Temperature Max. ($T_{s_{max}}$) Time ($T_{s_{min}}$ to $T_{s_{max}}$) (ts)	150 °C 200 °C 60~180 seconds
TIME MAINTAINED ABOVE: Temperature (T_l) Time (t_l)	217 °C 60~150 seconds
Peak Temperature (T_p)	260 °C
Time within 5 °C of Actual Peak Temperature (t_p)	20~40 seconds
Ramp-Down Rate	6 °C / second max.
Time 25 °C to Peak Temperature	8 minutes max.

How to Order

MF - USML 400 / 12 - 2

Multifuse®
Product Designator
Series
USML = 1210 Low Ohmic Surface Mount Component
Hold Current, I_{hold}
175 - 700 (1.75 Amps - 7.0 Amps)
Maximum Voltage, V_{max}
12 = 12 Volts
6 = 6 Volts
Packaging
-2 = Tape and Reel
Packaged per EIA-481

Typical Part Marking

Represents total content. Layout may vary.

PART IDENTIFICATION:

MF-USML175/6 = H6	MF-USML400/6 = U6
MF-USML175/12 = H12	MF-USML400/12 = U12
MF-USML200/6 = J6	MF-USML450/6 = X6
MF-USML200/12 = J12	MF-USML450/12 = X12
MF-USML260/6 = N6	MF-USML500/6 = Y6
MF-USML260/12 = N12	MF-USML500/12 = Y12
MF-USML300/6 = P6	MF-USML550/6 = 56
MF-USML300/12 = P12	MF-USML550/12 = 512
MF-USML350/6 = S6	MF-USML600/6 = Z6
MF-USML350/12 = S12	MF-USML650/6 = 66
MF-USML380/6 = V6	MF-USML700/6 = A6
MF-USML380/12 = V12	

MANUFACTURING
DATE CODE IS
LOCATED ON
PACKING LABEL.

Specifications are subject to change without notice.

Users should verify actual device performance in their specific applications.

The products described herein and this document are subject to specific legal disclaimers as set forth on the last page of this document, and at www.bourns.com/docs/legal/disclaimer.pdf.

MF-USML/X Series - Low Ohmic PTC Resettable Fuses



Packaging Specifications

MF-USML/X Series per EIA-481

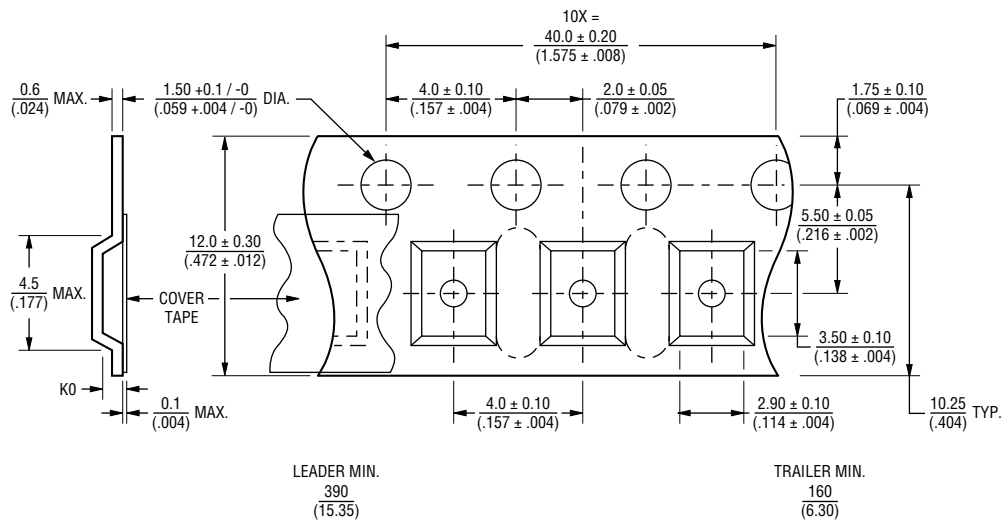

K0	Dimensions
0.65 ± 0.10 (.026 ± .004)	MF-USML175/6 ~ MF-USML260/6, MF-USML175/12 ~ MF-USML260/12
1.10 ± 0.10 (.043 ± .004)	MF-USML300/6 ~ MF-USML700/6, MF-USML300/12 ~ MF-USML550/12

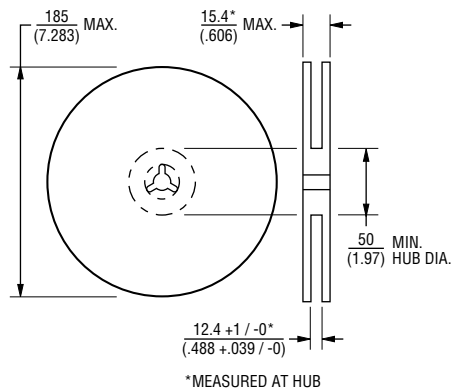

DIMENSIONS: $\frac{MM}{(INCHES)}$



Asia-Pacific: Tel: +886-2 2562-4117 • Email: asiacus@bourns.com

EMEA: Tel: +36 88 885 877 • Email: eurocus@bourns.com

The Americas: Tel: +1-951 781-5500 • Email: americus@bourns.com

www.bourns.com

MF-USML/X SERIES, REV. C, 10/21

Specifications are subject to change without notice.

Users should verify actual device performance in their specific applications.

The products described herein and this document are subject to specific legal disclaimers as set forth on the last page of this document, and at www.bourns.com/docs/legal/disclaimer.pdf.

Application Notice

- Users are responsible for independent and adequate evaluation of Bourns® Multifuse® Polymer PTC devices in the user's application, including the PPTC device characteristics stated in the applicable data sheet.
- Polymer PTC devices must not be allowed to operate beyond their stated maximum ratings. Operation in excess of such maximum ratings could result in damage to the PTC device and possibly lead to electrical arcing and/or fire. Circuits with inductance may generate a voltage above the rated voltage of the polymer PTC device and should be thoroughly evaluated within the user's application during the PTC selection and qualification process.
- Polymer PTC devices are intended to protect against adverse effects of temporary overcurrent or overtemperature conditions up to rated limits and are not intended to serve as protective devices where overcurrent or overvoltage conditions are expected to be repetitive or prolonged.
- In normal operation, polymer PTC devices experience thermal expansion under fault conditions. Thus, a polymer PTC device must be protected against mechanical stress, and must be given adequate clearance within the user's application to accommodate such thermal expansion. Rigid potting materials or fixed housings or coverings that do not provide adequate clearance should be thoroughly examined and tested by the user, as they may result in the malfunction of polymer PTC devices if the thermal expansion is inhibited.
- Exposure to lubricants, silicon-based oils, solvents, gels, electrolytes, acids, and other related or similar materials may adversely affect the performance of polymer PTC devices.
- Aggressive solvents may adversely affect the performance of polymer PTC devices. Conformal coating, encapsulating, potting, molding, and sealing materials may contain aggressive solvents including but not limited to xylene and toluene, which are known to cause adverse effects on the performance of polymer PTCs. Such aggressive solvents must be thoroughly cured or baked to ensure their complete removal from polymer PTCs to minimize the possible adverse effect on the device.
- Recommended storage conditions should be followed at all times. Such conditions can be found on the applicable data sheet and on the Multifuse® Polymer PTC Moisture/Reflow Sensitivity Classification (MSL) note:
https://www.bourns.com/docs/RoHS-MSL/msl_mf.pdf