

MFBM1V2012

Multilayer chip ferrite bead



Product features

- 0805 (2012 metric) package
- High current handling
- Multilayer monolithic construction yields high reliability
- Impedance range from 0 Ω to 1000 Ω

Applications

- Industrial connectivity (IoT)
- Wireless communications
- Bluetooth
- WiFi
- Antenna
- Machine-to-machine (M2M)
- Mobile phones
- Wearable devices
- Wireless LAN
- Computing/gaming consoles
- Broadband components
- RF transceiver modules

Environmental compliance and general specifications

- Operating temperature range: -40 °C to +85 °C (ambient plus self-temperature rise)



Product specifications

Part number ³	Impedance tolerance	Impedance (Ω)	DCR (Ω) maximum @ +25 °C	Test frequency ¹ (MHz)	Test voltage ¹ (mV)	Rated I ² (mA) maximum
MFBM1V2012-000-R	0~15 Ω	0	0.01	100	50	6000
MFBM1V2012-050-R	0~15 Ω	5	0.01	100	50	6000
MFBM1V2012-070-R	0~11 Ω	7	0.01	100	50	6000
MFBM1V2012-090-R	5~13 Ω	9	0.01	100	50	6000
MFBM1V2012-110-R	7~15 Ω	11	0.01	100	50	6000
MFBM1V2012-150-R	9~21 Ω	15	0.01	100	50	6000
MFBM1V2012-190-R	12~25 Ω	19	0.01	100	50	6000
MFBM1V2012-300-R	±25%	30	0.01	100	50	6000
MFBM1V2012-310-R	±25%	31	0.01	100	50	6000
MFBM1V2012-500-R	±25%	50	0.04	100	50	3500
MFBM1V2012-600-R	±25%	60	0.04	100	50	3500
MFBM1V2012-700-R	±25%	70	0.04	100	50	3000
MFBM1V2012-800-R	±25%	80	0.04	100	50	3000
MFBM1V2012-101-R	±25%	100	0.05	100	50	3000
MFBM1V2012-121-R	±25%	120	0.05	100	50	3000
MFBM1V2012-151-R	±25%	150	0.08	100	50	2500
MFBM1V2012-181-R	±25%	180	0.08	100	50	2500
MFBM1V2012-221-R	±25%	220	0.08	100	50	2500
MFBM1V2012-301-R	±25%	300	0.08	100	50	2500
MFBM1V2012-301-R	±25%	300	0.08	100	50	2500
MFBM1V2012-501-R	±25%	500	0.10	100	50	2000
MFBM1V2012-601-R	±25%	600	0.10	100	50	2000
MFBM1V2012-102-R	±25%	1000	0.12	100	50	1500

1. Impedance test frequency and voltage.

2. Rated I: Current rating for an approximate self-temperature rise of 40 °C or less.

3. Part number definition: MFBM1V2012-xxx-R

MFBM1V2012 = Product code and size

xxx = Impedance value in Ω, last character equals number of zeros

-R suffix = RoHS compliant

Mechanical parameters, schematic, pad layout (mm)

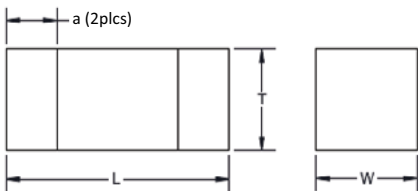

Recommended pad layout

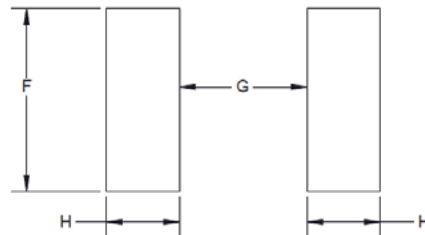

Schematic

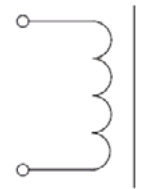

Part number	L	W	T	a	F	G	H
MFBM1V2012-xxx-R	2.0 ±0.20	1.2 ±0.20	0.9 ±0.20	0.5 ±0.3	1.60 ref	0.20 ref	1.20 ref

Part marking: No marking

All soldering surfaces to be coplanar within 0.1 millimeters

Tolerances are ±0.1 millimeters unless stated otherwise

Pad layout dimensions are reference only

Traces or vias underneath the inductor is not recommended

Packaging information (mm)

Drawing not to scale

Supplied in tape and reel packaging, 4000 parts per 7" diameter reel

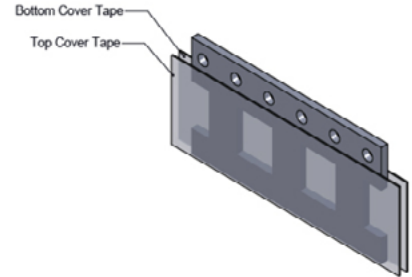
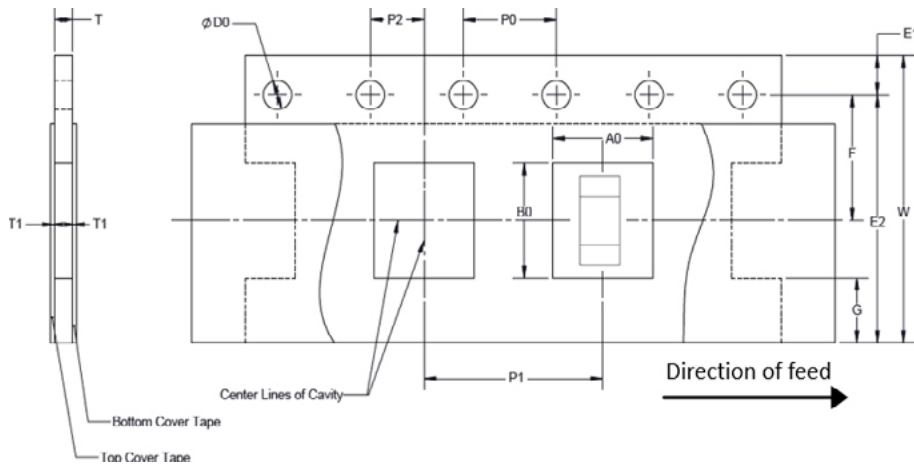

$W \pm 0.2$	8.00
$F \pm 0.1$	3.50
$E1 \pm 0.2$	1.75
$E2$ Min	na
$P0 \pm 0.2$	4.00
$P1 \pm 0.2$	4.00
$P2 \pm 0.1$	2.00
$D0 \pm 0.1$	1.55
$A0$	1.5 ± 0.2
$B0$	2.3 ± 0.2
T	0.95 ± 0.1
$T1$ Max	na

Qualification testing

No.	Test item	Sample size (pcs)	Test condition	Acceptable value/range
1	External visual	72	Specification	No physical damage
2	Physical dimension	72	Specification	Specification
3	Initial electrical test	72	Specification	User specification
4	Solderability	6	+245 °C ±5 °C, dipping 5 ±1s	>95% solder coverage
5	Resistance to soldering heat	6	+260 °C ±5 °C for 10 ±1 s	1. $\Delta Z/Z < \pm 30\%$ 2. No physical damage
6	Terminal strength (SMD)	6	Force of 10 N for 10 ±1 s	No physical damage No electrical performance test
7	Low temperature exposure	6	-40 °C for 1000 hours	1. $\Delta Z/Z < \pm 30\%$ 2. No physical damage
8	Bending strength	6	Appendix 2 note: 2 mm, hold time 30 s (minimum)	No physical damage No electrical performance test
9	Drop	6	Drop 10 times to a concrete floor from a height of 1 m	1. $\Delta Z/Z < \pm 30\%$ 2. No physical damage
10	Vibration	6	Amplitude modulation:1.5 mm Test time: A period of 2 hours in each of 3 mutually perpendicular directions Test from 10 Hz to 55 Hz to 10 Hz for 1 minute	1. $\Delta Z/Z < \pm 30\%$ 2. No physical damage
11	High temperature exposure	6	+85 °C for 1000 hours	1. $\Delta Z/Z < \pm 30\%$ 2. No physical damage
12	Biased humidity	6	1000 hours +60 °C/90% to 95% RH unpowered	1. $\Delta Z/Z < \pm 30\%$ 2. No physical damage
13	Operational life	12	+85 °C at rated current for 1000 hours	1. $\Delta Z/Z < \pm 30\%$ 2. No physical damage
14	Temperature cycling	6	32 cycles (-40 °C to +85 °C), dwell time 30 minutes	1. $\Delta Z/Z < \pm 30\%$ 2. No physical damage

Impedance vs frequency

MFBM1V2012-000-R

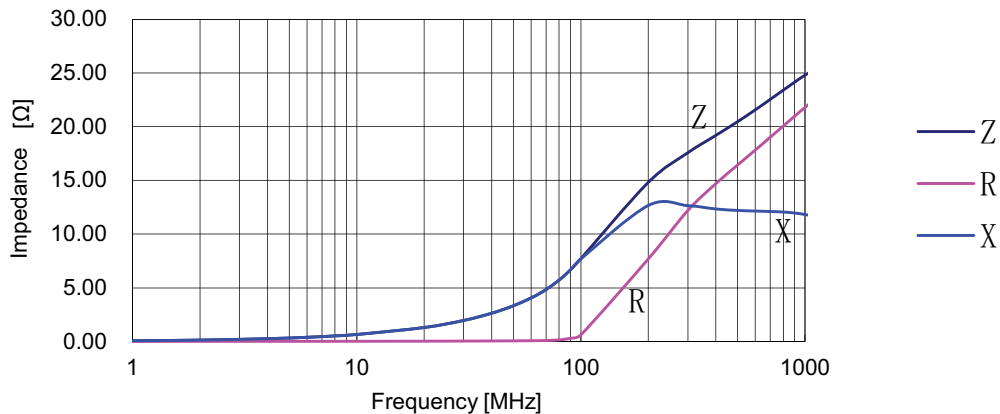

MFBM1V2012-600-R

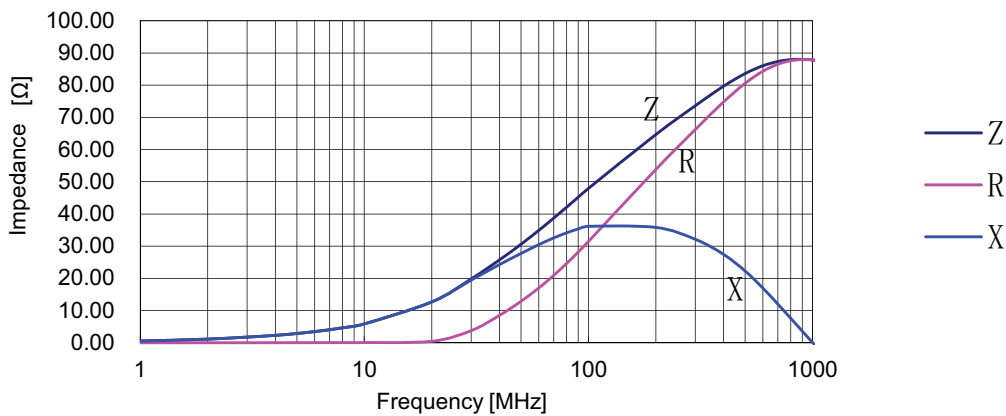

MFBM1V2012-102-R

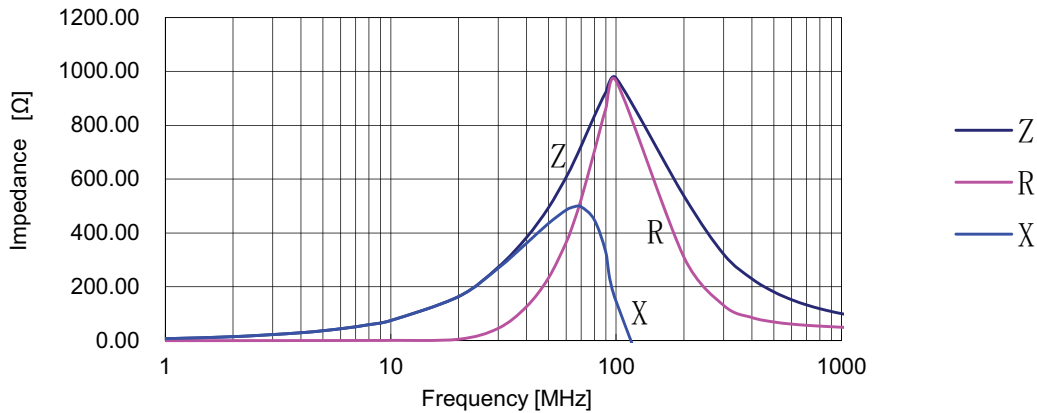

Z= impedance, R= resistance, X= reactance